

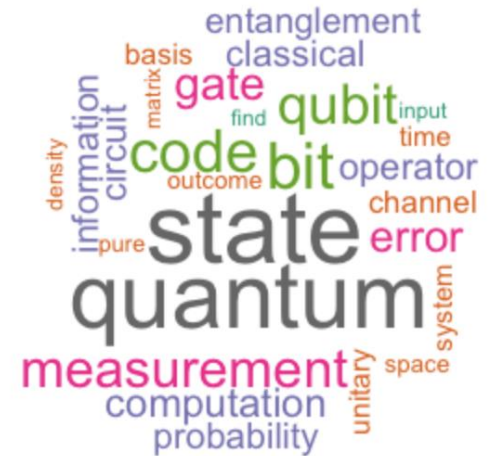

Perspectives on Quantum Information Science

Joe Lykken
Fermilab



ASCAC Meeting April 17, 2018

The age of quantum computing and quantum communications is getting closer

Even after allowing for media hype, very impressive progress in the last few years on building real quantum computers and performing long-range quantum communication

Chinese scientists just teleported an object into Earth's orbit for the first time

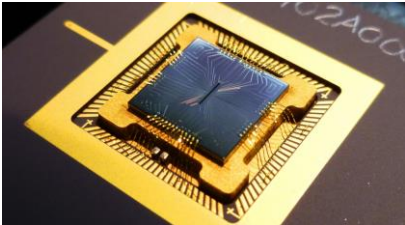

IBM Raises the Bar with a 50-Qubit Quantum Computer

Intel's New Chip Aims For Quantum Supremacy

The troubled chipmaking giant is one of the first to build a quantum computing chip that can outrun a modern classical supercomputer.

NEWS IN BRIEF QUANTUM PHYSICS

Google moves toward quantum supremacy with 72-qubit computer

Intelligent Machines

Serious quantum computers are finally here. What are we going to do with them?

Hello, quantum world.

Knight February 21, 2018



What is a quantum digital computer?

- Information is stored and manipulated as quantum states “**qubits**”
- A single qubit state is in general a **quantum superposition** of two distinct states, which we will denote as state $|0\rangle$ and state $|1\rangle$:

$$|\psi\rangle = \cos \frac{\theta}{2} |0\rangle + e^{i\phi} \sin \frac{\theta}{2} |1\rangle$$

- The two angles parameterize the surface of a sphere, called the Bloch sphere
- Classical computing only accesses the North and South poles of the Bloch sphere

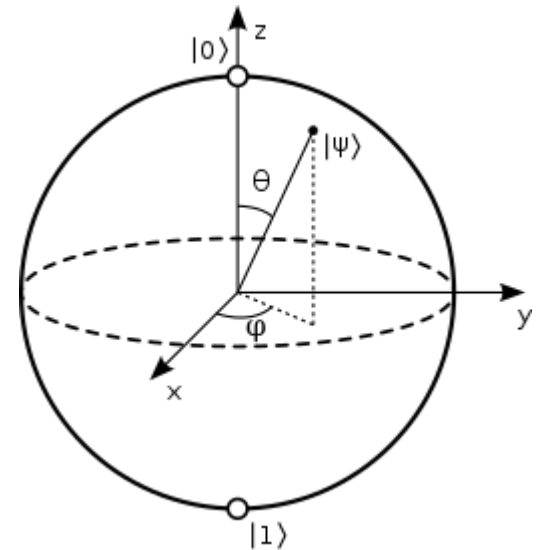

Quantum circuits

- Given some number of qubits in arbitrary states, I can measure each qubit state
- The measurement projects the n-qubit quantum state to an n-bit classical binary number
- We call this a projection to the **“computational basis”**
- This is the simplest quantum circuit

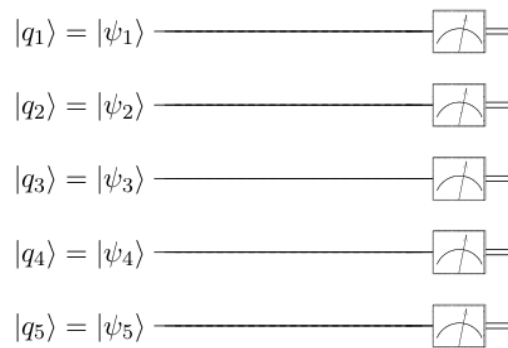

- More generally we can perform a variety of unitary operations, called **gates**, on the qubits before making measurements
- Gates operations can act on a single qubit, or on multiple qubits
- Starting from a rather small menu of gates one can obtain a **universal quantum computer**

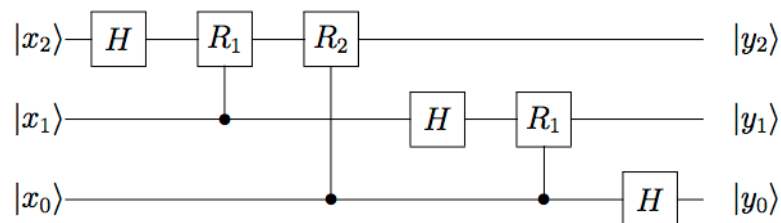

Can quantum circuits solve hard problems?

- Here is a quantum circuit that maps a 3-qubit input state $|x_1\rangle|x_2\rangle|x_3\rangle$ to an output state $|y_1\rangle|y_2\rangle|y_3\rangle$, where

$$|y_2\rangle|y_1\rangle|y_0\rangle = \frac{1}{\sqrt{8}} \left(|0\rangle_2 + \exp[i\pi x_0] |1\rangle_2 \right) \left(|0\rangle_1 + \exp[i\pi(x_1 + \frac{x_0}{2})] |1\rangle_1 \right) \left(|0\rangle_0 + \exp[i\pi(x_2 + \frac{x_1}{2} + \frac{x_0}{4})] |1\rangle_0 \right)$$

- This is a (discrete) **Fourier transform**
- The quantum circuit uses two kinds of gate operations:

- A Hadamard gate that acts on a single qubit:
- A controlled phase shift: a two qubit gate that applies a phase shift to the target qubit that depends on the state of the control qubit

$$H = \frac{1}{\sqrt{2}} \begin{pmatrix} 1 & 1 \\ 1 & -1 \end{pmatrix}$$

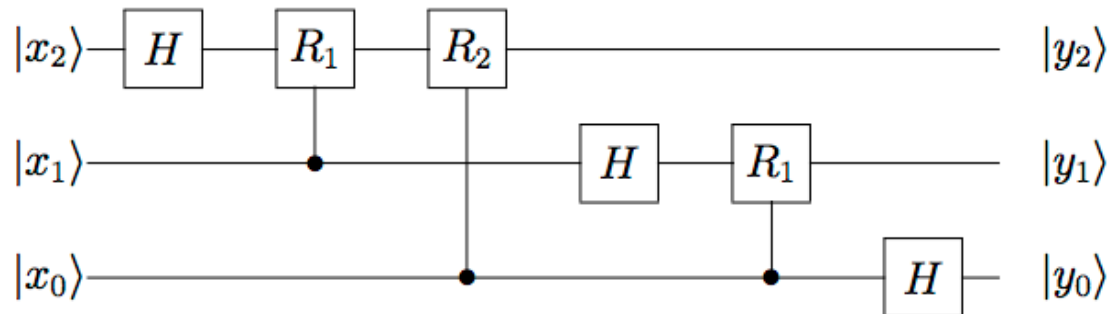

Exponential speedup

- The discrete Fourier transform is an example of a calculation that a quantum computer can do exponentially faster than any classical computer: for n qubits we need $\sim n^2$ gate operations, whereas a conventional Fast Fourier Transform requires $\sim n^{2^n}$ operations
- In 1994 Peter Shor showed that **factorization of prime numbers** can be done with a combination of quantum Fourier transforms and classical operations that run in polynomial time
- Thus a quantum computer with a sufficiently large number of qubits and reliable single and 2-qubit gate operations can do at least one important calculation **exponentially faster than a classical computer**

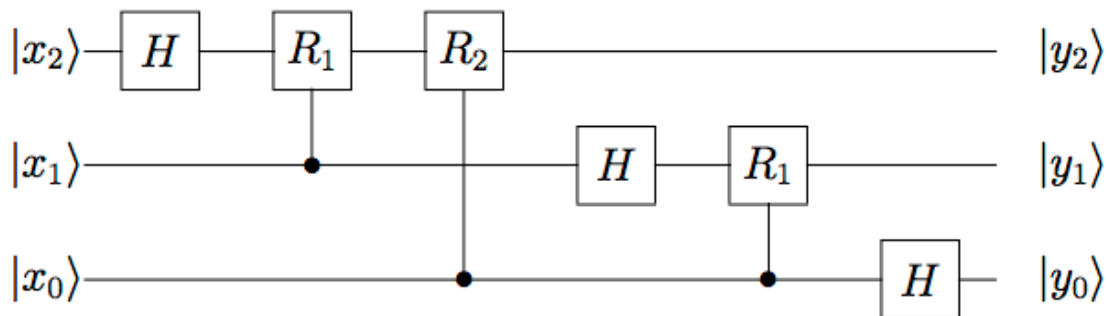

Rapid progress in building quantum computers

Moore's Law is over (?) and has been replaced by Martinis' Law (?): the number of qubits in high performance quantum computers will double every 18 months

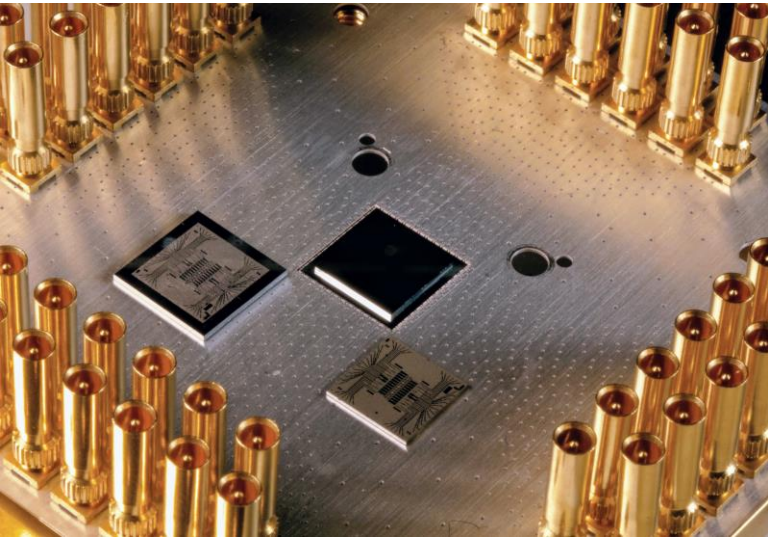

Google 22-qubit quantum computer, 2017



Google 72-qubit quantum computer, 2018

A **performant** 72-qubit quantum computer can achieve “**quantum supremacy**” = the ability to do at least **some** (not necessarily useful) calculations that cannot be reproduced by the world's largest classical supercomputers

Analog computers

- Analog computers are in principle more powerful for certain applications than universal digital computers
- Classical analog computers were the dominant form of computing until fairly recently



Antikythera mechanism,
Greece circa 100 BCE

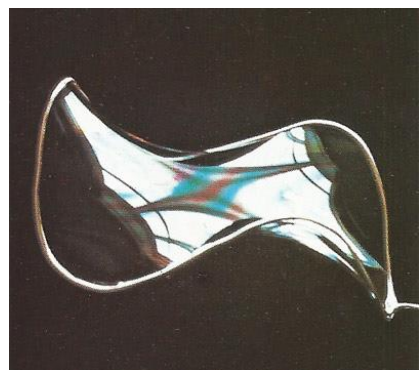

Soap bubble

Tide calculator
USA until 1965

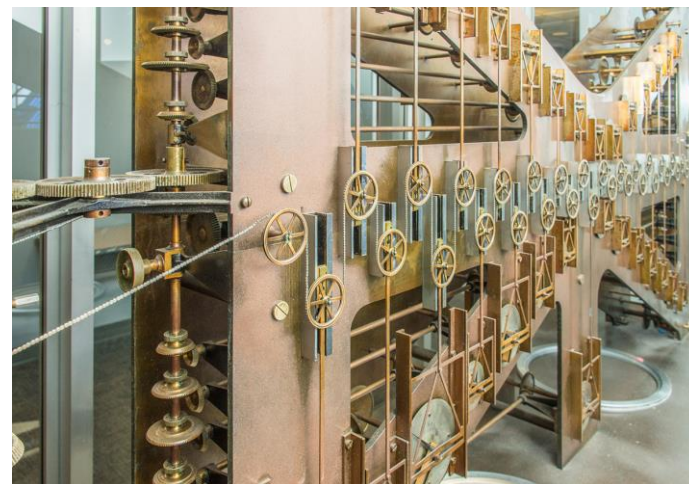

Richard Feynman 1981

“Nature isn’t classical, dammit, and if you want a simulation of nature, you’d better make it quantum mechanical”

- First person to propose the idea of quantum computing and explain its potential importance
- In addition to universal digital quantum computers, proposed quantum analog computers where the quantum behavior of the one system simulates the quantum behavior of some other system that you want to better understand
- In other words, **use quantum hardware to simulate quantum problems**
- This is very different from building a gate-based quantum computer to do prime factorization, which is a classical problem

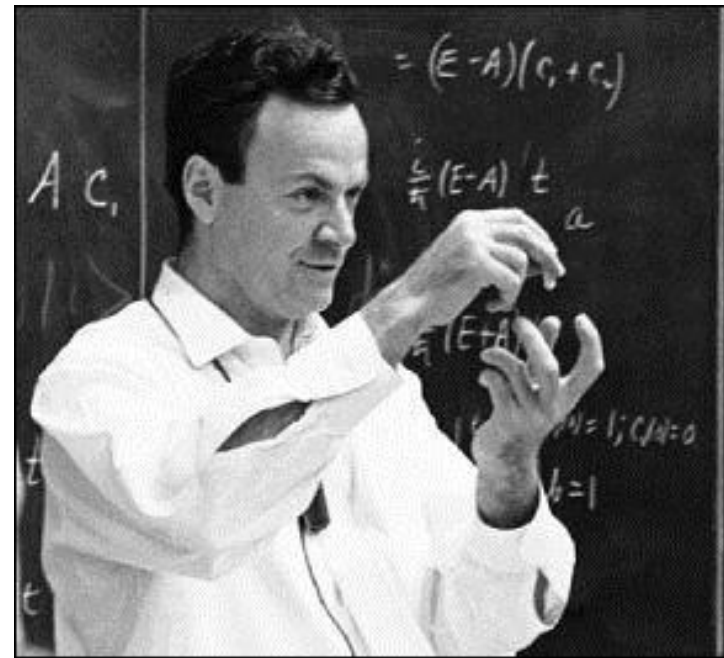

Challenges of building quantum computers

Need a qubit, i.e. a two-state quantum system, that you can manipulate and not confuse with other possible states of the system.

You must be able to create states that are superpositions of your two basis states, and maintain the **quantum coherence** long enough to perform a series of quantum manipulations

Examples of qubits:

- Photon polarization
- Photons in two time bins
- Electron spin, nuclear spin, atomic spin
- Ground state and particular excited state of an ion
- Ground state and first excited state of a nonlinear oscillator, e.g. a superconducting Josephson Junction LC circuit



From qubits to quantum systems

For good qubits you need

- Quantum coherence
- Pairwise coupling of qubits (for 2-qubit gates)
- Ability to create initial state, perform qubit gate operations, and measure final state
- Low rate of errors; ability to detect errors and do **error correction**

Then scale this all up to a large quantum system

Extra challenge: you cannot copy quantum information (no-cloning theorem)

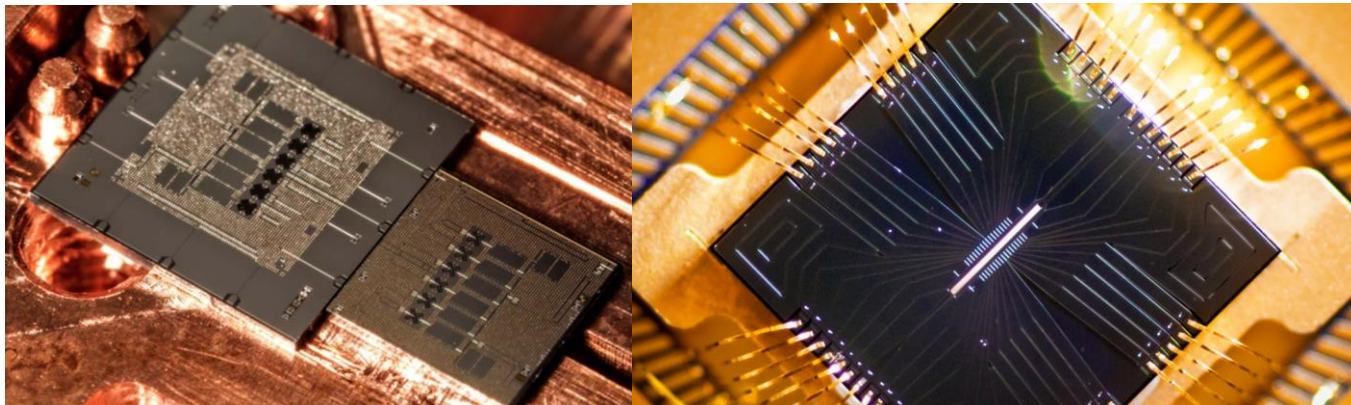

Superconducting quantum computers

Lots of groups working with variations on superconducting Josephson Junction circuits, in some cases with very fast and very high fidelity (low error rate) gate operations

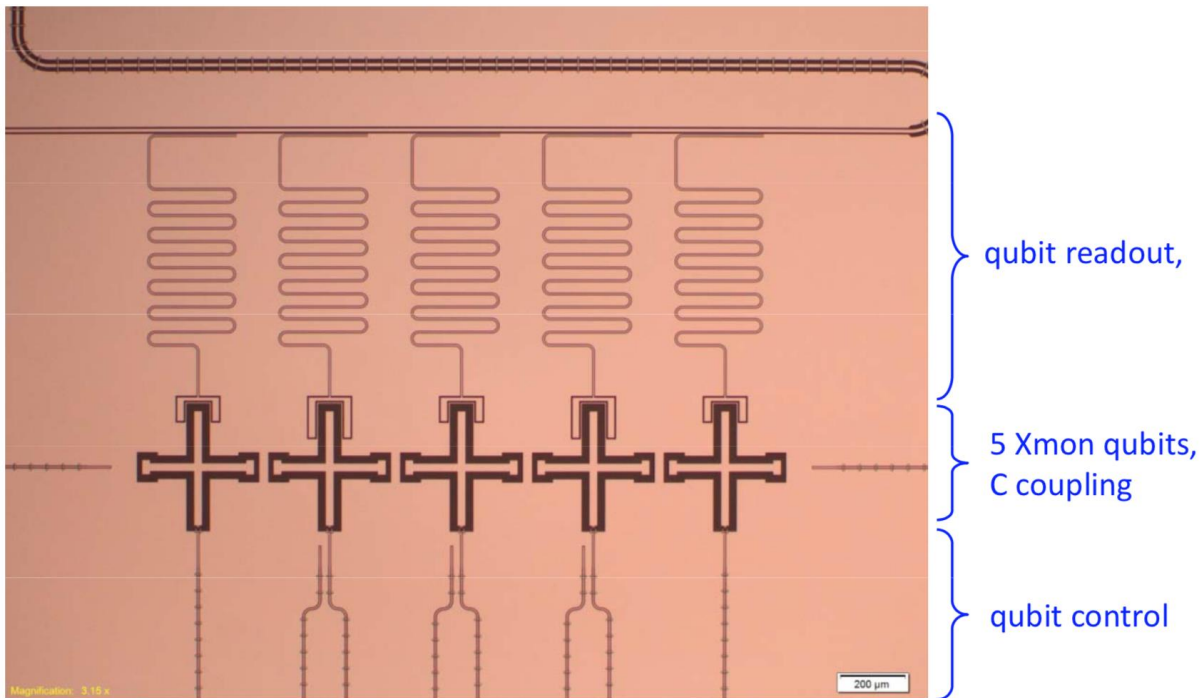

Gate	Fidelity (%)	Gate Time
X	99.95	20ns
Y	99.95	20ns
X/2	99.93	20ns
Y/2	99.93	20ns
-X	99.92	20ns
-Y	99.90	20ns
-X/2	99.93	20ns
-Y/2	99.93	20ns
H	99.91	40ns
Z	99.97	10ns
Z/2	99.98	10ns

Similar performance with 2-qubit gates: 99.4%, 40 ns

John Martinis superconducting Xmon qubits

Superconducting 3D quantum computers

In 2011 the Yale group showed that there are great advantages to putting your Josephson Junction qubits inside superconducting microwave cavities

“3D transmon”

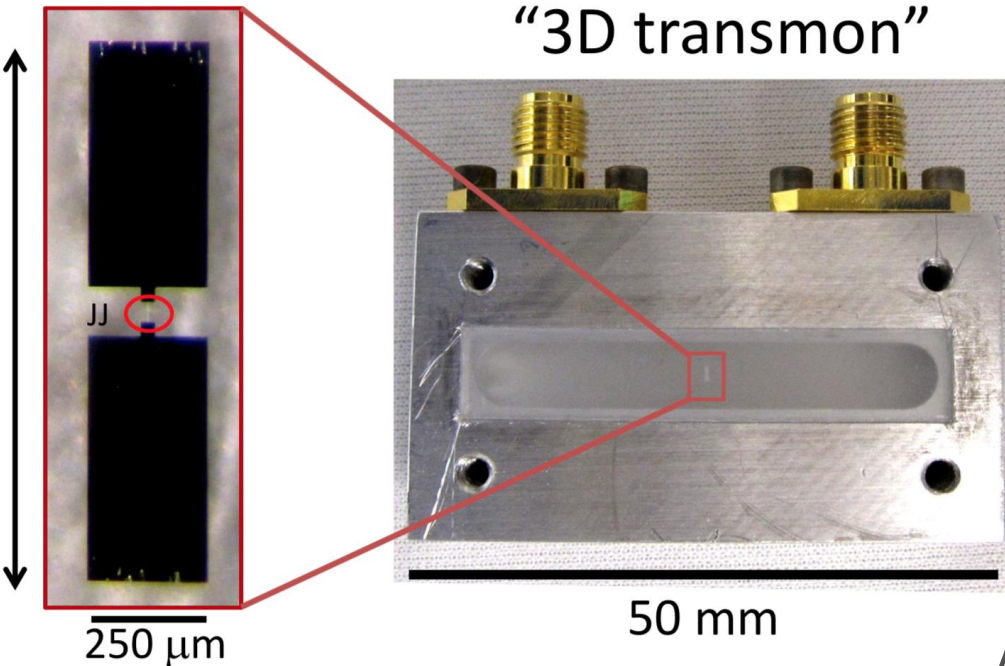

Good for:

- Isolation
- Control
- Readout

Achieved record long quantum coherence times, as measured by T_2 , the dephasing time of superposition states

H. Paik et al, PRL 107, 240501 (2011)

3D qubits/cavities give the best quantum coherence

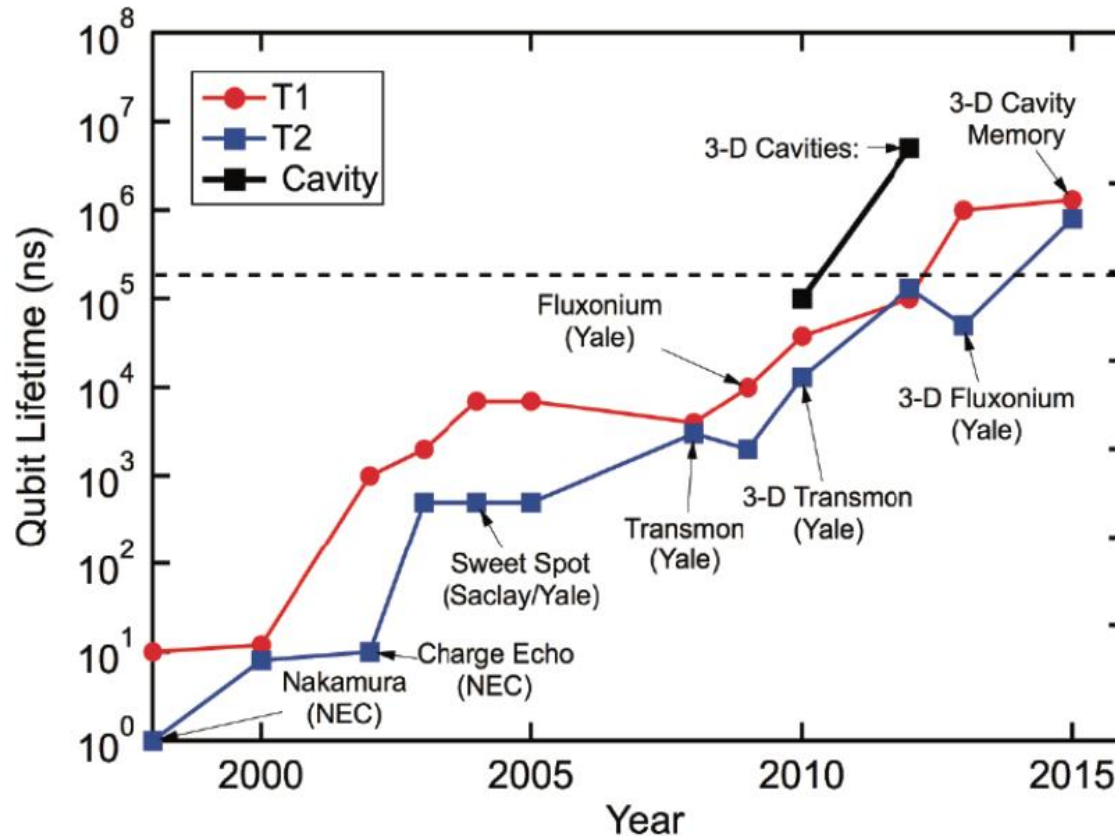

T_2 of ~ a millisecond means you can think about quantum circuits with depth ~ 10,000

Can we do even better?

The science of superconducting cavities

At Fermilab we use superconducting cavities in the microwave/RF frequency band for particle accelerators

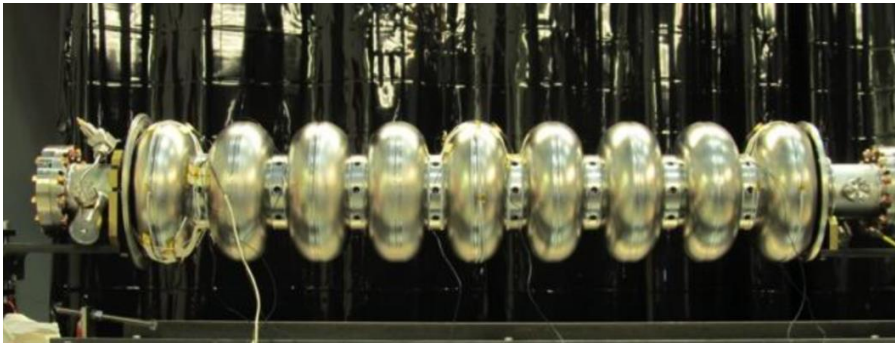
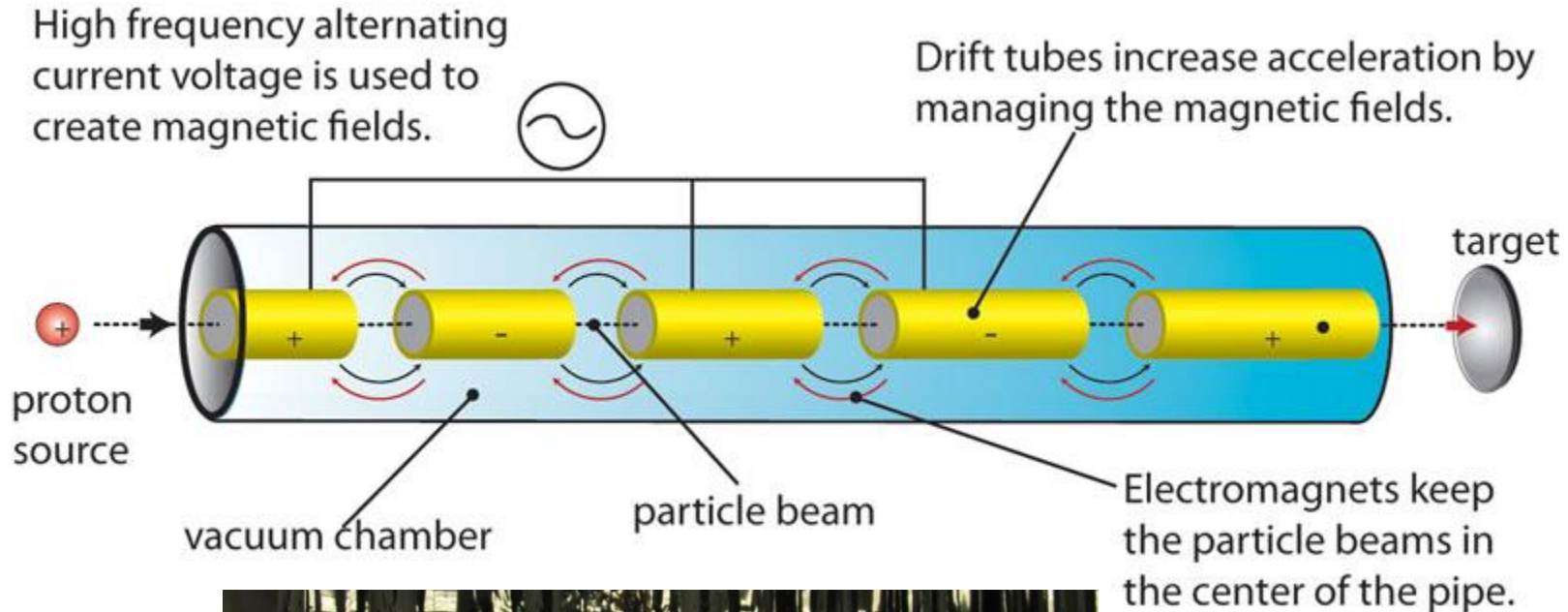

The science of superconducting cavities

At Fermilab we make SRF cavities from niobium, and assemble them into cryomodules that in turn are assembled into linear accelerators

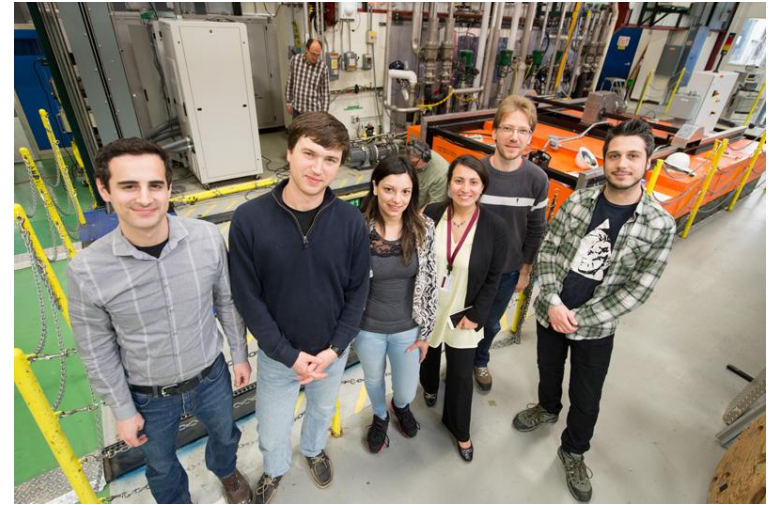

Alex Romanenko and Anna Grassellino lead the Fermilab SRF cavity program



Cryomodule built at Fermilab for the new LCLS-II free electron laser light source at SLAC

The Q of superconducting cavities

For an accelerator you want to achieve very high accelerating gradients (e.g. 30 megavolts/meter), and very high quality factor Q

High Q means that the resonant cavities “ring” longer and thus need less microwave power pumped into them

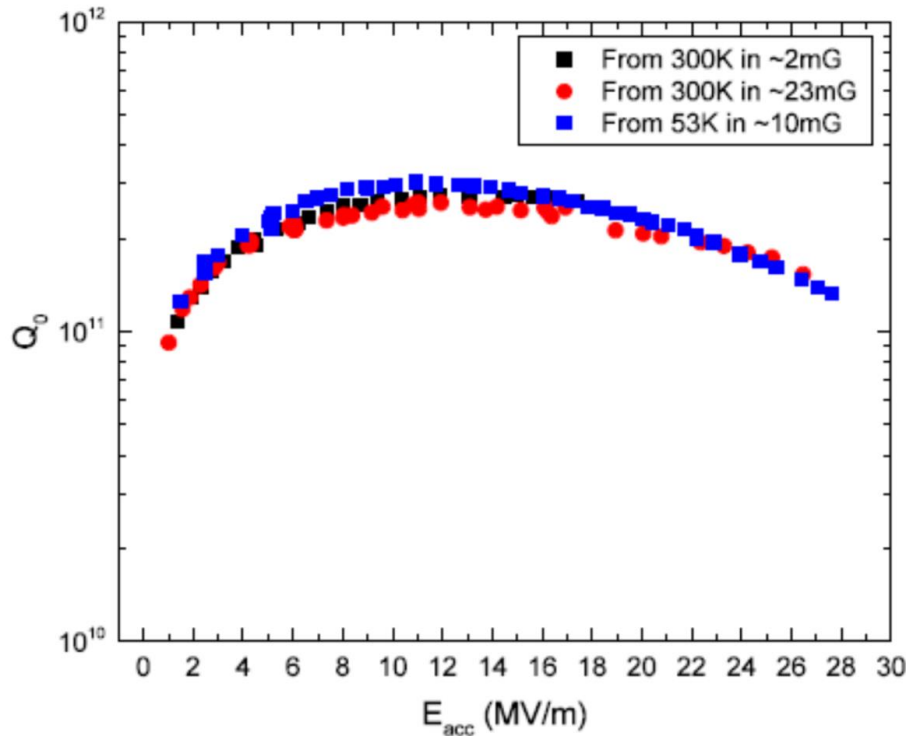

Thanks to recent breakthroughs by Fermilab scientists, we now routinely achieve Q near or above 10^{11}

If Galileo had rung a bell with this value of Q, it would still be ringing today

A. Romanenko, A. Grassellino et al. J. Appl. Phys. 115, 184903 (2014)
A. Romanenko, A. Grassellino et al. Appl. Phys. Lett. 105, 234103 (2014)

Niobium SRF cavities for quantum computers?

Challenges:

- For accelerator cavities you want high gradients = as many photons as possible; for a quantum computer you want cavities containing **a single microwave photon**
- Accelerators operate at temperatures around 2K, quantum computers around 20 milliKelvin

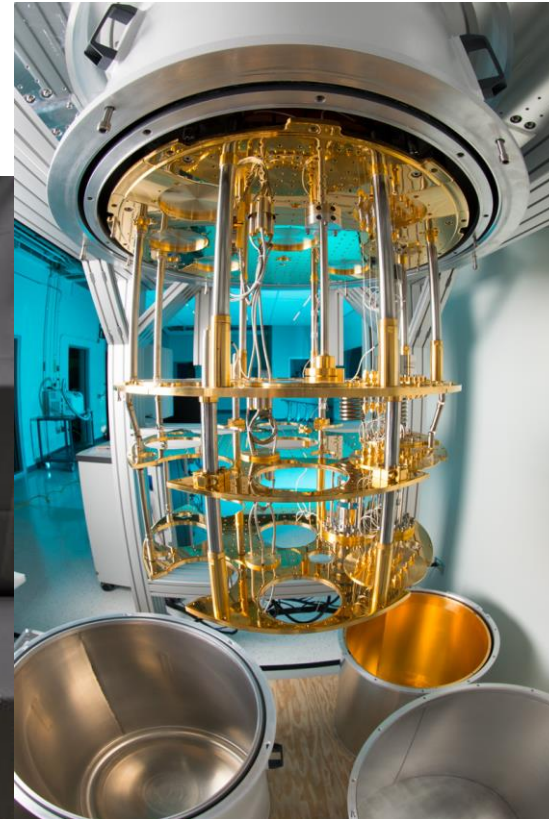

First try at $T \sim 12$ mK, down to ~ 1000 photons

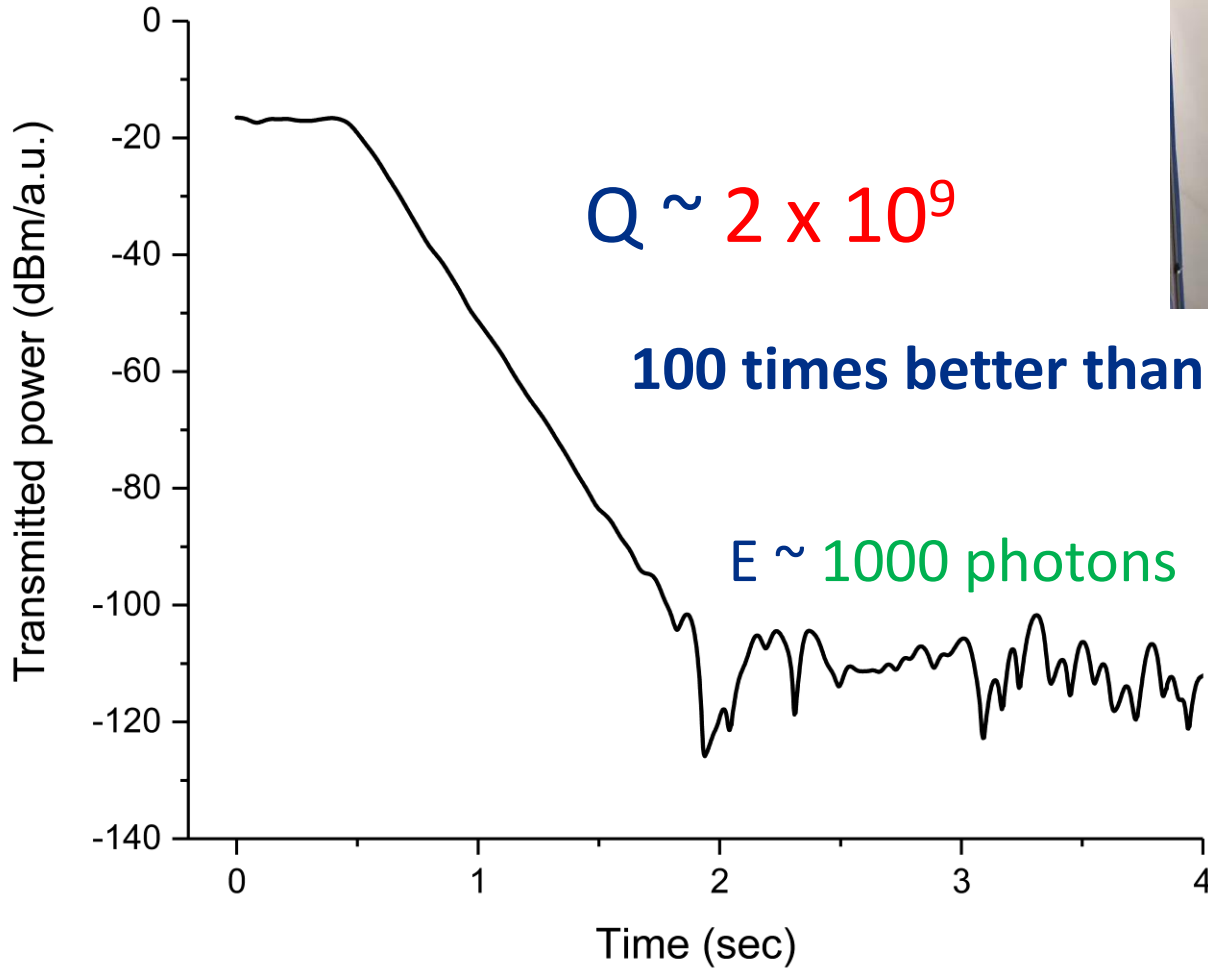

$Q \sim 2 \times 10^9$

100 times better than previous record

$E \sim 1000$ photons

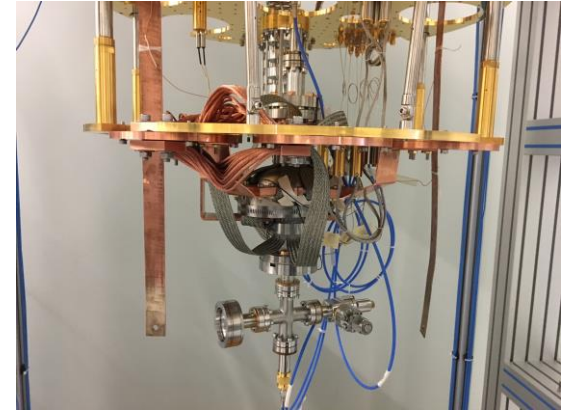

Publication with full details in preparation

Why does Fermilab care about superconducting qubits?

Fermilab is devoted to basic research in high energy physics (HEP)

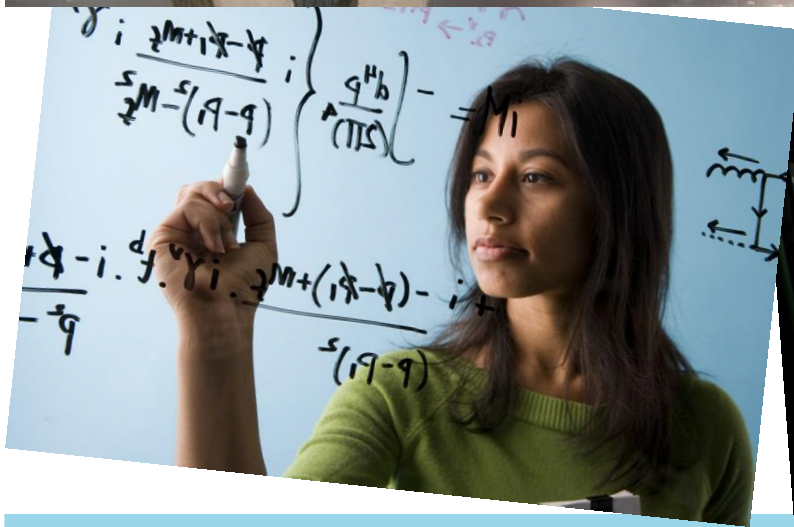
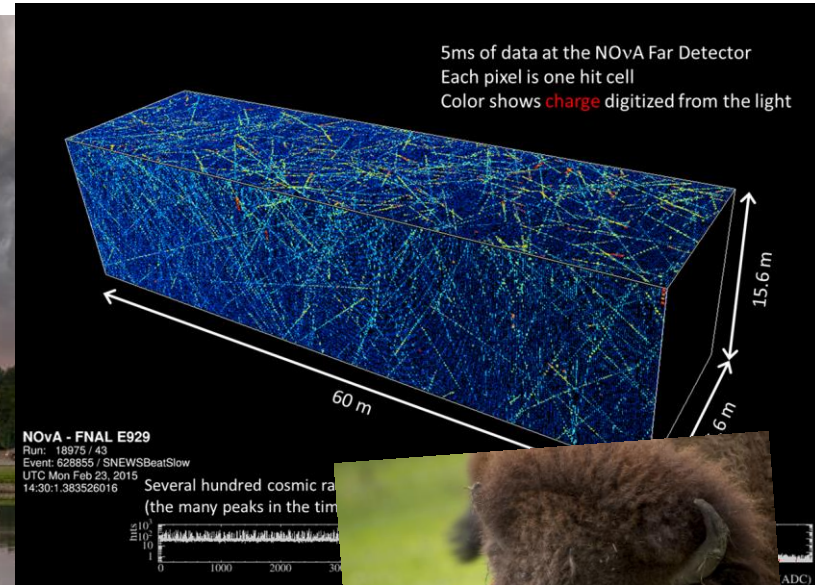

Fermilab

HEP experiments use a lot of computing

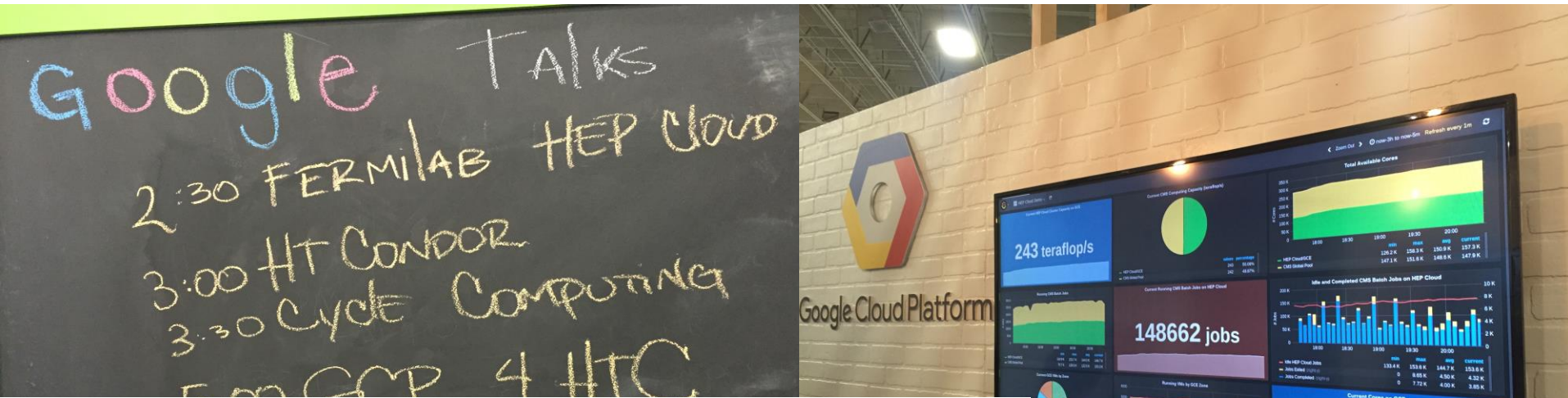

Doubling CMS compute capacity

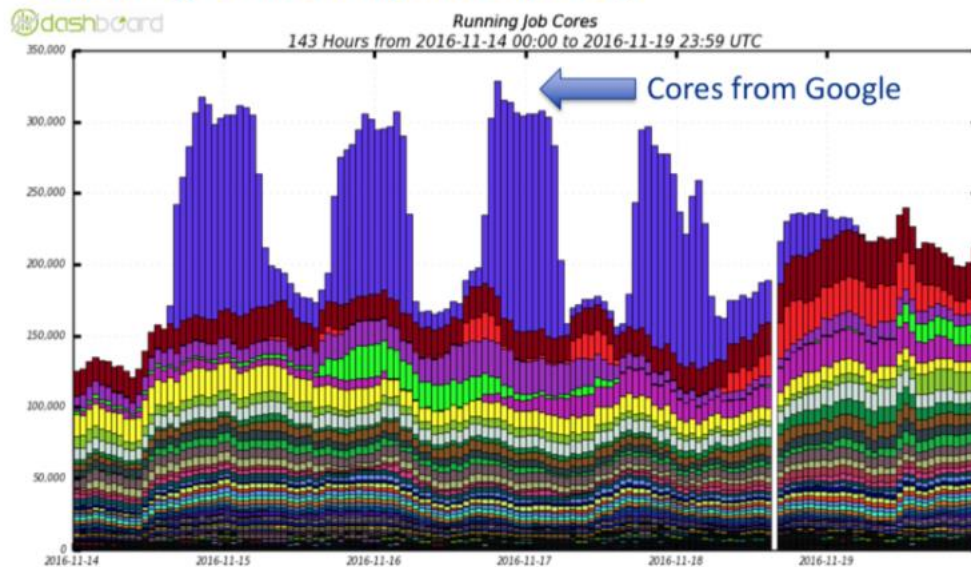

Figure 2: HEPCloud demonstration with the Google Cloud Platform (GCP) at Supercomputing 2016. The cores used on the GCP are indicated. Other colors show computing resources from other sites.

HEP applications of quantum computers

Long view:

- Most particle physics applications will require thousands, if not millions, of error-corrected qubits, which won't be available for ~20 years
- However Fermilab is planning experiments that will be running 20 years from now, e.g. the DUNE neutrino experiment, and the CMS experiment at the LHC



What can we do now?

- Identify pieces of problems that we care about that can be addressed with near-term quantum technologies

Applications of today's quantum computers: quantum machine learning

- Many particle physics experiments already using deep learning to better classify, e.g. neutrino-induced interactions in particle detectors
- Some standard machine learning techniques, e.g. Boltzmann machines, involve **estimating the ground state of a Hamiltonian** that has many local minima

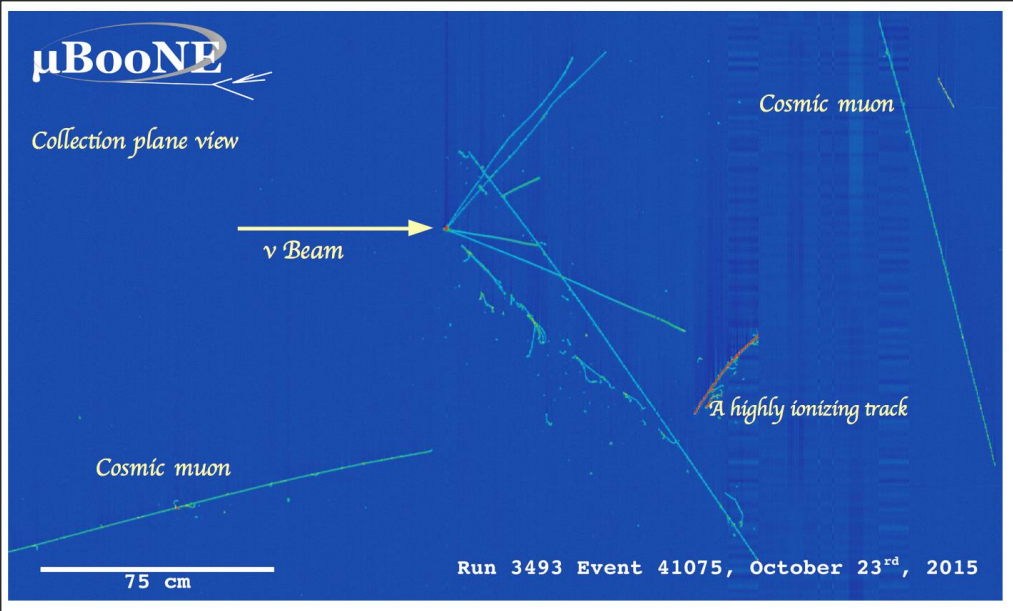
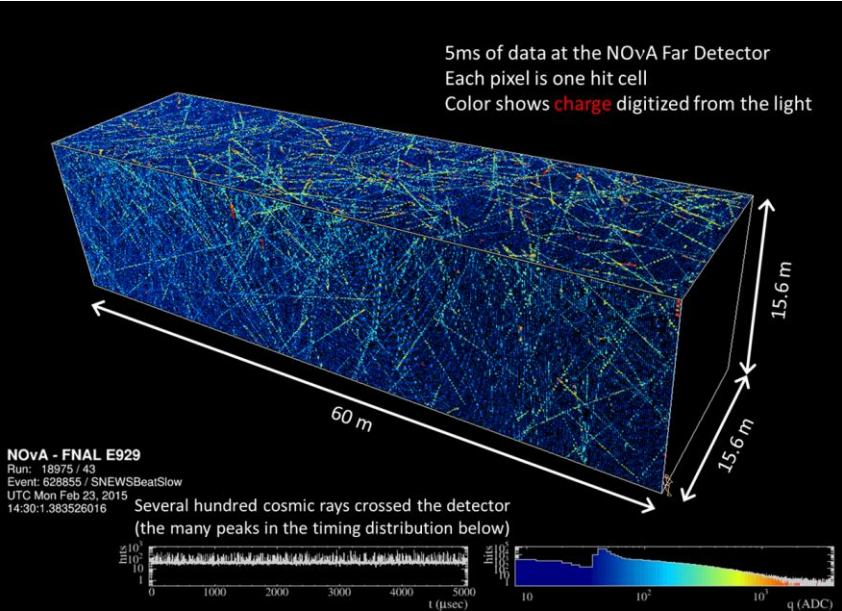

Applications of today's quantum computers: quantum machine learning with quantum annealers

- Annealing is a standard classical process for trying to avoid getting stuck in a local minimum
- **Quantum annealing** improves this by adding the possibility of quantum tunneling

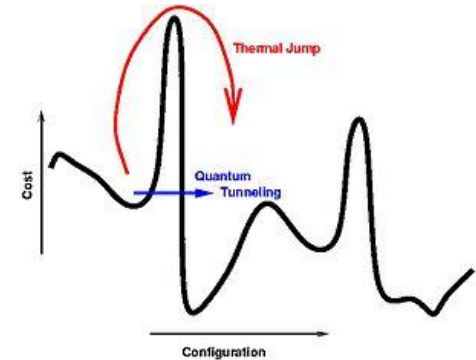

- D-Wave makes a quantum computer with 2,000 superconducting qubits that functions as a quantum annealer
- This is an **analog quantum computer**, not a gate-programmable computer

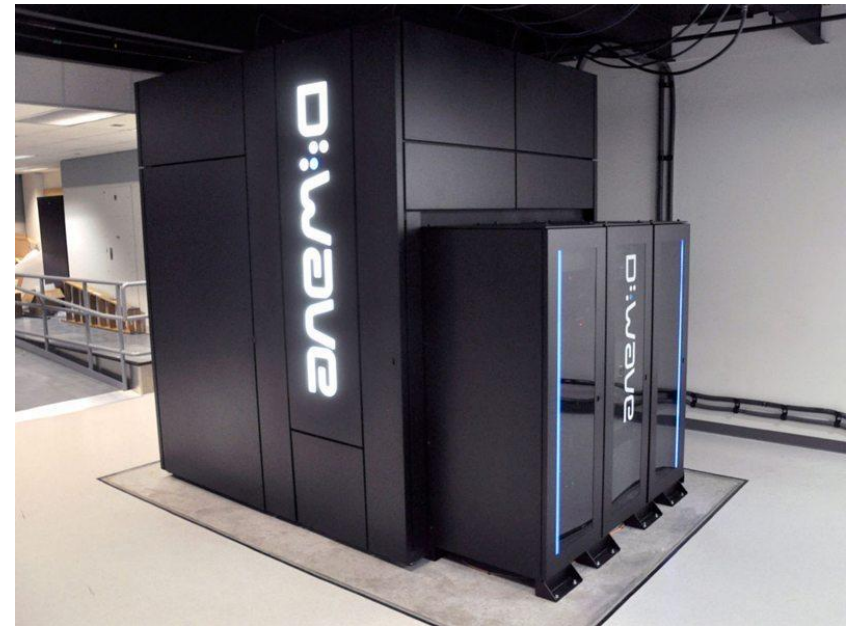

Quantum machine learning to identify Higgs bosons

- This has been applied to classifying CMS collisions events from the Large Hadron Collider, to better identify events that produce a Higgs boson
- The quantum annealer trains faster than a classical annealer
- Is this useful in practice? Too soon to tell.

1 Solving a Higgs optimization problem with quantum 2 annealing for machine learning

3 Alex Mott^{1*}, Joshua Job², Jean-Roch Vlimant¹, Daniel Lidar³, and Maria Spiropulu^{1*}

4 ¹Department of Physics, California Institute of Technology, Pasadena, 91125, USA

5 ²Department of Physics, and Center for Quantum Information Science & Technology, University of Southern
6 California, Los Angeles, California 90089, USA

7 ³Departments of Electrical Engineering, Chemistry and Physics, and Center for Quantum Information Science &
8 Technology, University of Southern California, Los Angeles, California 90089, USA

9 *Now at DeepMind

10 *smaria@caltech.edu

A. Mott et al, Nature 19 Oct 2017



Ned Allen and Adam Salamon (Lockheed-Martin), Maria Spiropulu (Caltech)

Quantum simulation: from fermions to bosons to gauge theories

arXiv.org > quant-ph > arXiv:1802.07347

Search or Article

(Help | Advanced search)

Quantum Physics

Electron-Phonon Systems on a Universal Quantum Computer

Alexandru Macridin, Panagiotis Spentzouris, James Amundson, Roni Harnik

(Submitted on 20 Feb 2018)

We present an algorithm that extends existing quantum algorithms for simulating fermion systems in quantum chemistry and condensed matter physics to include phonons. The phonon degrees of freedom are represented with exponential accuracy on a truncated Hilbert space with a size that increases linearly with the cutoff of the maximum phonon number. The additional number of qubits required by the presence of phonons scales linearly with the size of the system. The additional circuit depth is constant for systems with finite-range electron-phonon and phonon-phonon interactions and linear for long-range electron-phonon interactions. Our algorithm for a Holstein polaron problem was implemented on an Atos Quantum Learning Machine (QLM) quantum simulator employing the Quantum Phase Estimation method. The energy and the phonon number distribution of the polaron state agree with exact diagonalization results for weak, intermediate and strong electron-phonon coupling regimes.

Subjects: **Quantum Physics (quant-ph)**; Strongly Correlated Electrons (cond-mat.str-el)

Cite as: **arXiv:1802.07347 [quant-ph]**

(or **arXiv:1802.07347v1 [quant-ph]** for this version)

Submission history

From: Alexandru Macridin [[view email](#)]

[v1] Tue, 20 Feb 2018 21:49:00 GMT (72kb)

Qubits for dark matter detection?

So far everything we know about dark matter is from its gravitational effects out in the cosmos

No one has detected dark matter particles in the laboratory

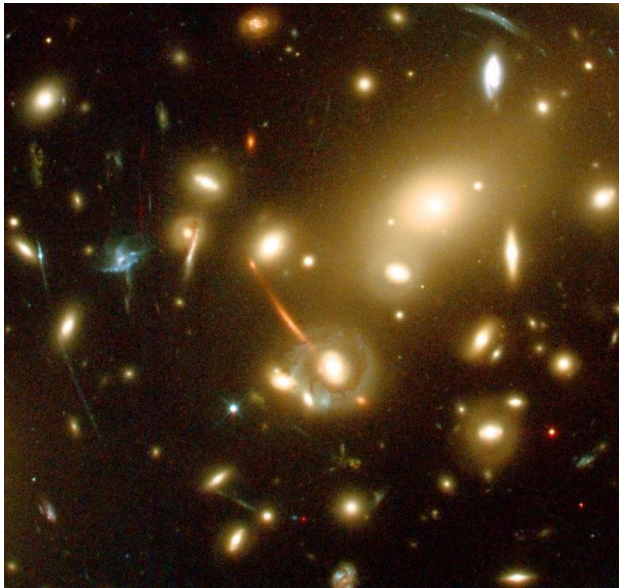

Gravitational lensing by dark matter distorts galaxy images

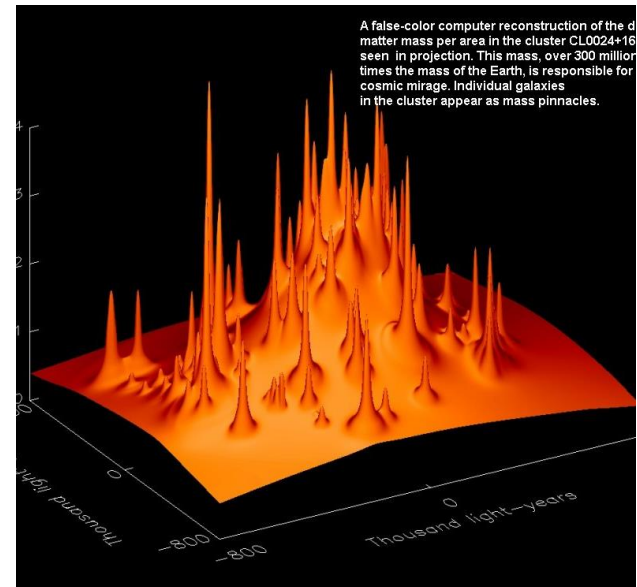

Distribution of dark matter needed to explain the lensing

Qubits for dark matter detection

There are many plausible theories for the identity of dark matter

- Superpartner particles: Wino, Bino, Higgsino, sneutrino, ...
- **Axions**
- Kaluza-Klein particles from extra dimensions
- Asymmetric dark matter
- WIMPzillas (don't ask...)



Dark matter streaming in from space may interact very weakly with ordinary matter

But the details depend on the mass and other properties of the dark matter particles

Searching for “axion” dark matter particles

DOE Gen2 Dark Matter Project (Fermilab-managed)



A resonant cavity “axion” dark matter search proceeds by tuning the radio frequency of the cavity and checking to see if you can hear the dark matter “radio broadcast” above the static noise



Simulated axion signal from ADMX

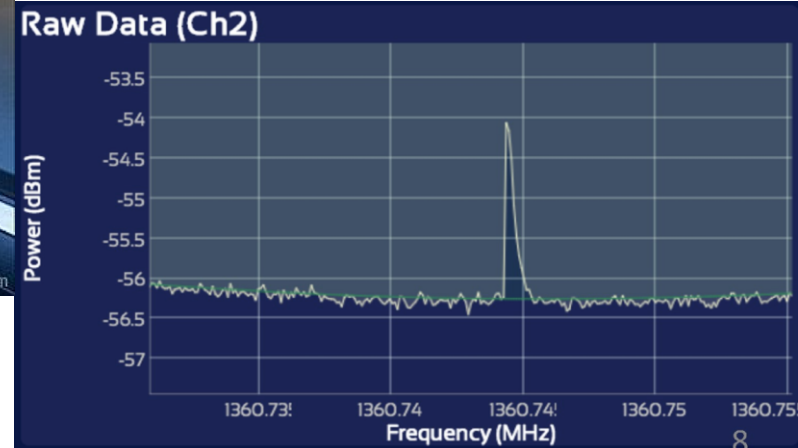

ADMX Experiment at U.Washington



Even at zero temperature, amplifiers for signal readout must add **quantum noise**

Signal wave

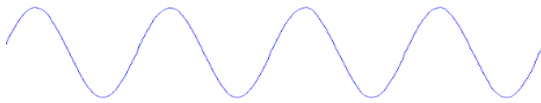

Amplification



to zoom in on
details of shape

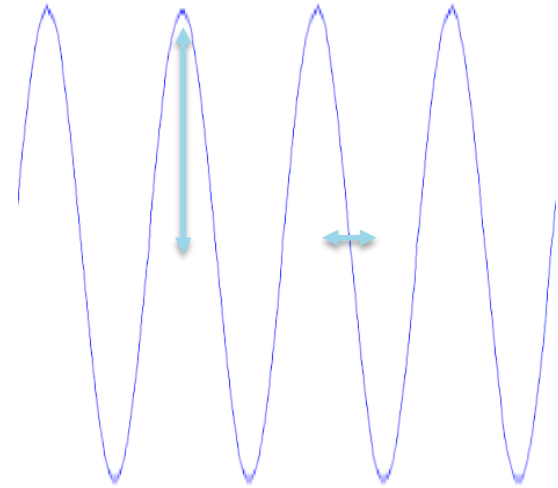

If no added noise, then one could simultaneously obtain arbitrarily precise information about both amplitude and phase, in violation of the **Heisenberg Uncertainty Principle**



Quantum-limited amplifiers ($T \rightarrow 0$ K) suffer from zero-point readout noise
 This is called the **Standard Quantum Limit (SQL)**

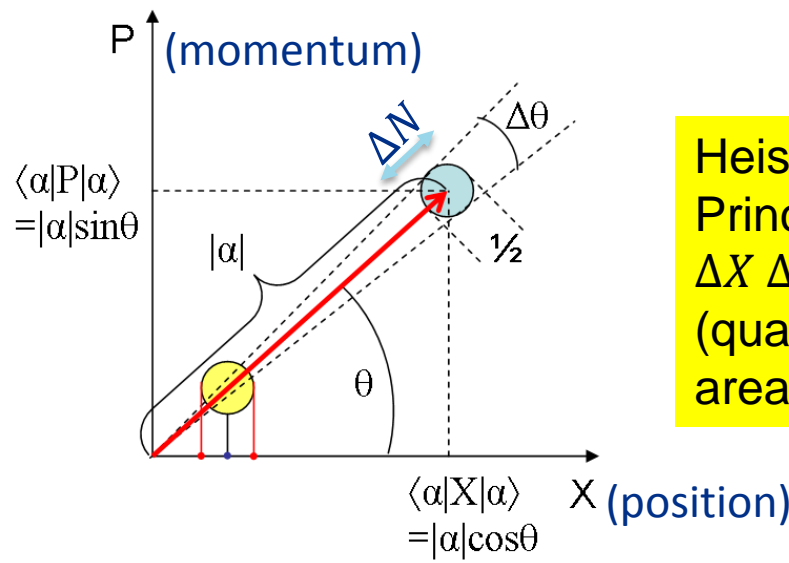
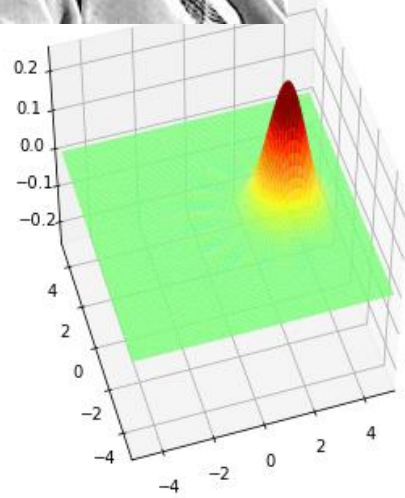

Heisenberg Uncertainty Principle
 $\Delta X \Delta P = \Delta N \Delta \theta = \frac{1}{2} \hbar$
 (quantum of phase space area)

Quantum noise = 1 photon of “zero point” noise per mode in the $T=0$ limit.
 (Caves, 1982)

But wait: **Quantum non-demolition (QND)** single photon detectors can do much better than SQL amplifiers

Measure photon number and put all backreaction into the unobserved phase of the wave – which we don't care about...

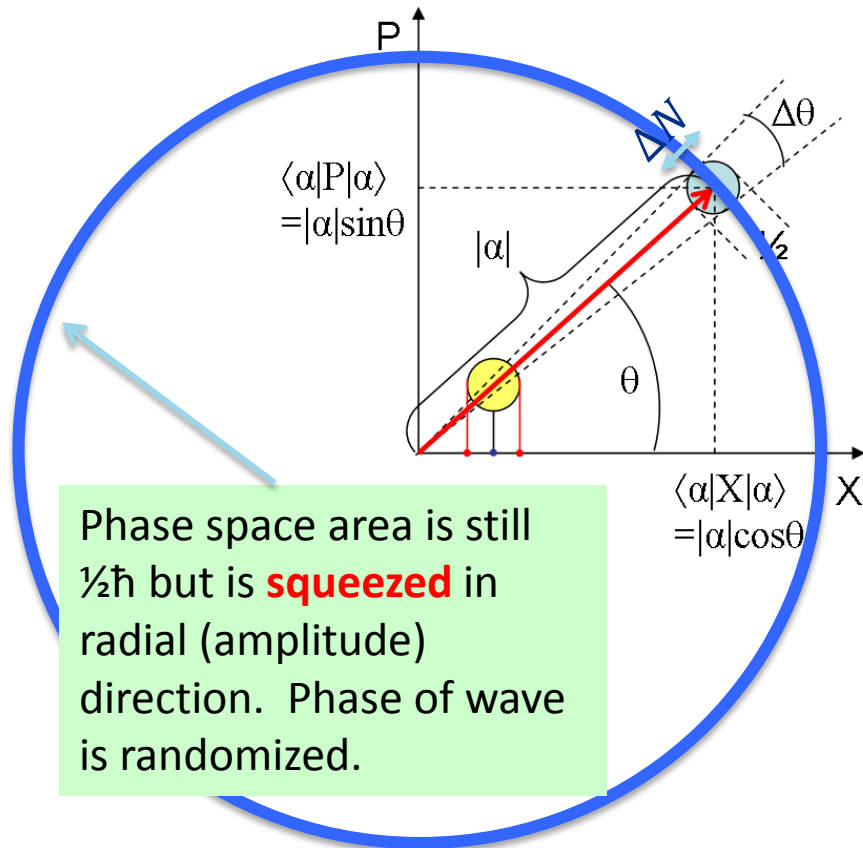

Demonstrated with Rydberg atoms, (Serge Haroche Nobel Prize 2012)

Implementation using **superconducting qubits**, D.Schuster et.al, 2007

Proposed for axion search: Lamoreaux, Lehnert, et.al, 2013, Zheng, Lehnert, et.al, 2016

Technology transfer from quantum computing to particle physics

Develop superconducting qubit-based single microwave photon detectors to enable a next generation dark matter axion search.



Aaron Chou, David Schuster (UC), Daniel Bowring

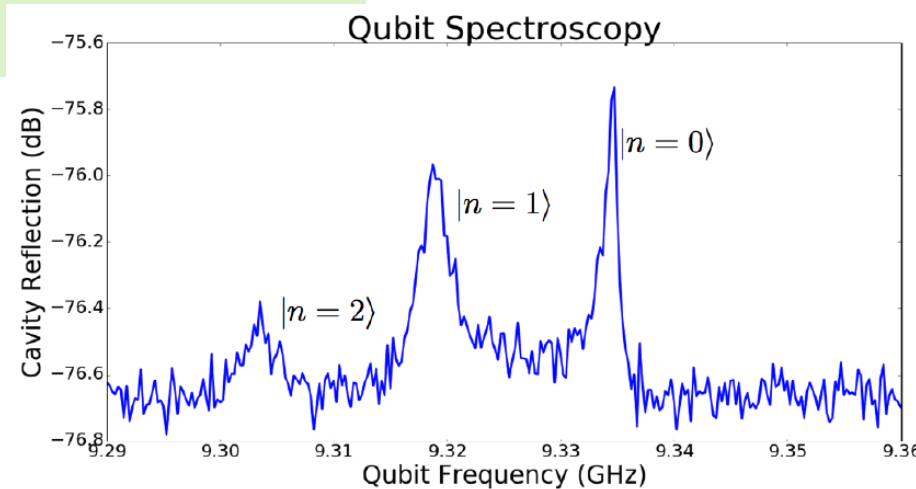

New Fermilab test stand incorporates magnet into a dilution refrigerator to simulate the extreme environment of a dark matter axion experiment.

Grad student Akash Dixit installing a prototype detector in a 10 mK test stand in the Schuster Lab.

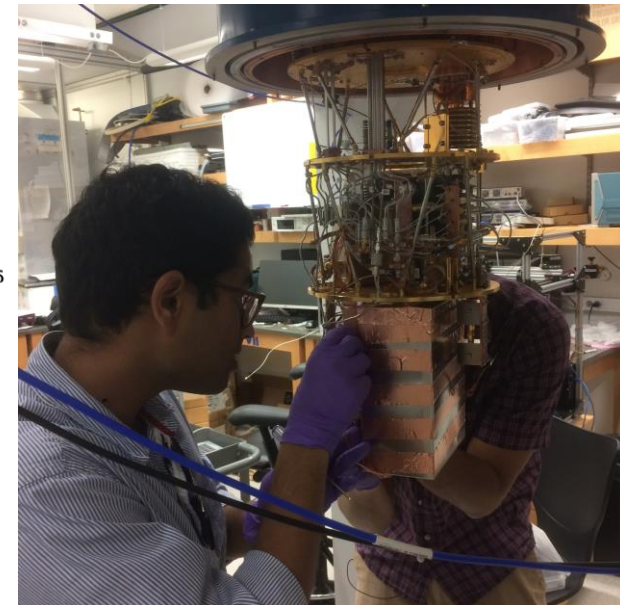

Cold atom interferometry

- It is straightforward to make an optical photon is a superposition of two states using beamsplitters
- More recently the Stanford group does the same thing with cold atoms

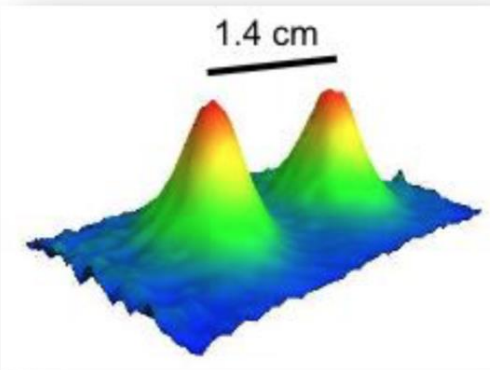
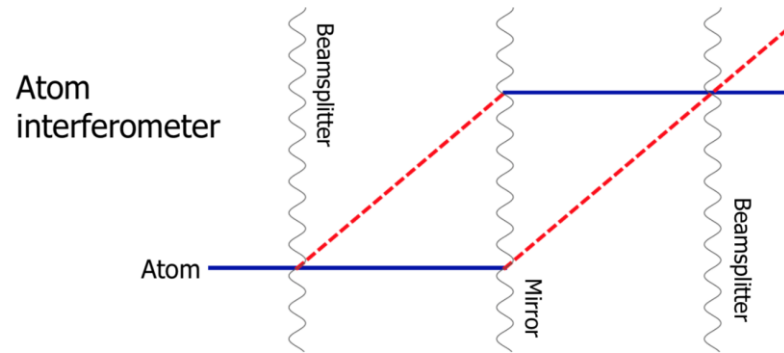
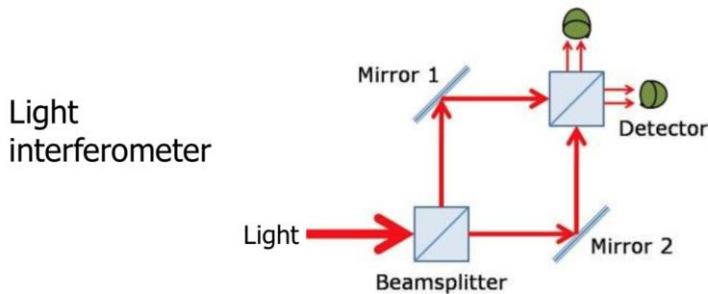

Wavepacket separation at apex (this data 50 nK)

Interference (3 nK cloud)

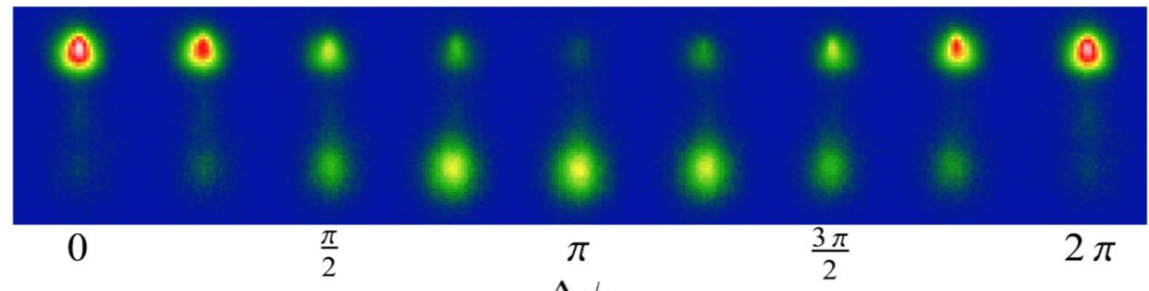

Dickerson et al, PRL 111, 083001 (2013)

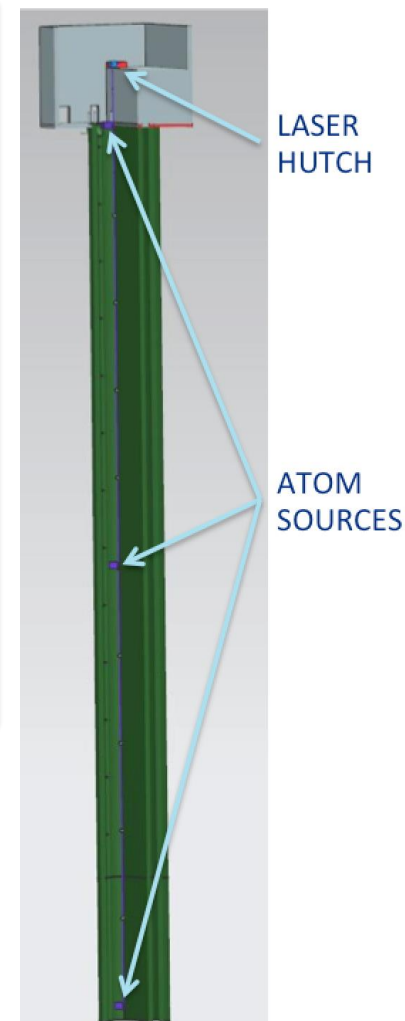
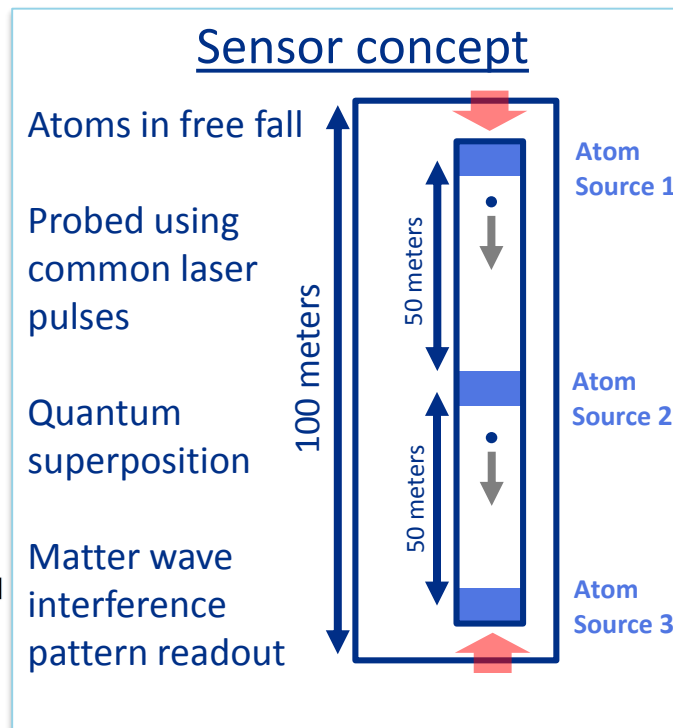
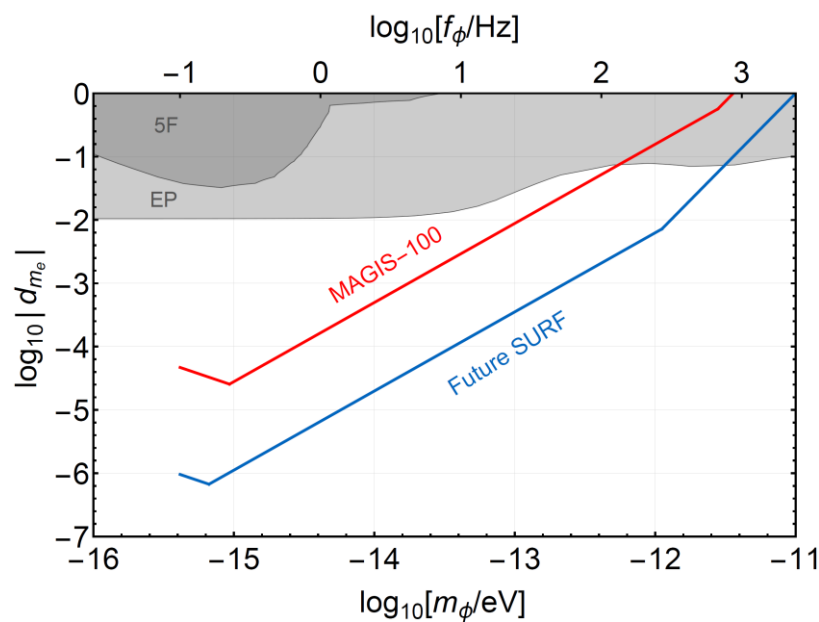

Quantum initiative

Atom matter waves in superposition separated by up to 10 meters, durations up to 9 seconds

Entangled atom source (spin squeezing) for increased sensitivity

Fundamental physics applications

Time-dependent signals from ultra-light dark matter

Fill the gravity wave frequency gap between LIGO and LISA

CAD model of detector in 100-meter MINOS shaft at Fermilab



Particle physics and quantum entanglement

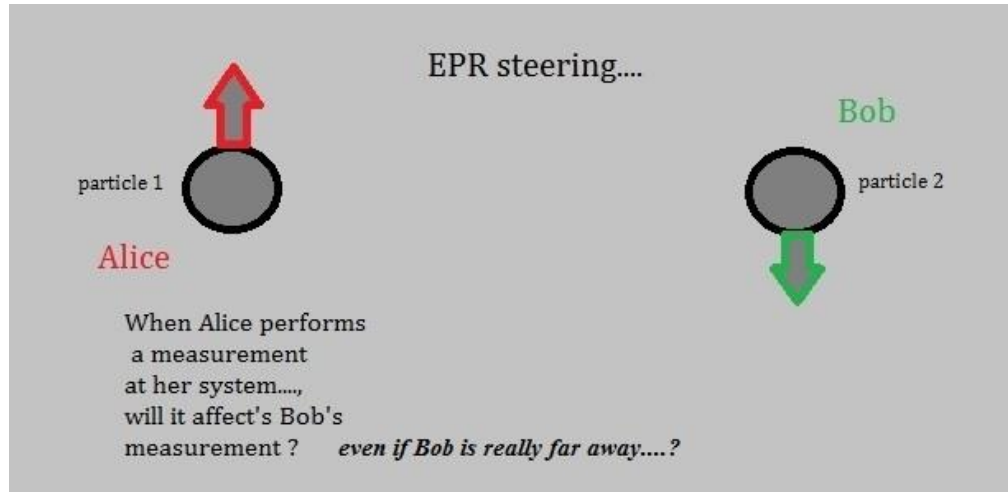

- The Einstein-Podolsky-Rosen “Paradox” involves the strange properties of **quantum entanglement**
- In modern language this involves two entangled qubits, q_A and q_B
- q_A is in a superposition of $|0\rangle$ and $|1\rangle$, as is q_B
- But this “**EPR pair**” is 100% correlated; this can be represented as a **Bell state, e.g.**

$$|\beta_{00}\rangle = \frac{1}{\sqrt{2}} (|00\rangle + |11\rangle)$$

Particle physics and quantum entanglement

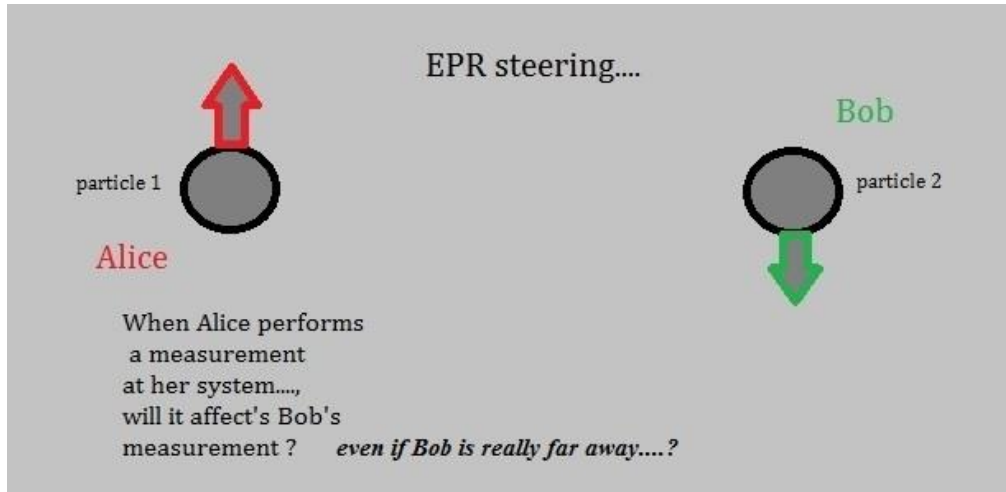

- Now suppose that we separate the EPR pair
- When Alice measures q_A , the state of q_B is **at that same moment** predicted with 100% certainty
- Einstein called this “*spukhafte Fernwirkung*”
- Bob can verify this, but he must wait to get Alice’s prediction, since she cannot transmit her prediction faster than the speed of light

Quantum teleportation

EPR pairs can also be used for **quantum teleportation**:

- Suppose Alice acquires an unknown single qubit photon state:
- If she measures it, it projects into one of the two computational basis states $|0\rangle$ or $|1\rangle$
- She cannot copy it, because of the no-cloning theorem
- Nevertheless if she and Bob already share the two members of an EPR photon pair, then **Alice can teleport her unknown quantum state to Bob**

Quantum teleportation protocol

- Alice entangles the two photons in her possession
- She measures her two photons in the computational basis, getting one of 4 possible results: $|00\rangle$, $|01\rangle$, $|10\rangle$, $|11\rangle$
- Alice sends Bob the result of her message
- Depending on Alice's message, Bob performs a particular single qubit operation on his photon
- Bob is now guaranteed to have the same unknown quantum state that Alice had

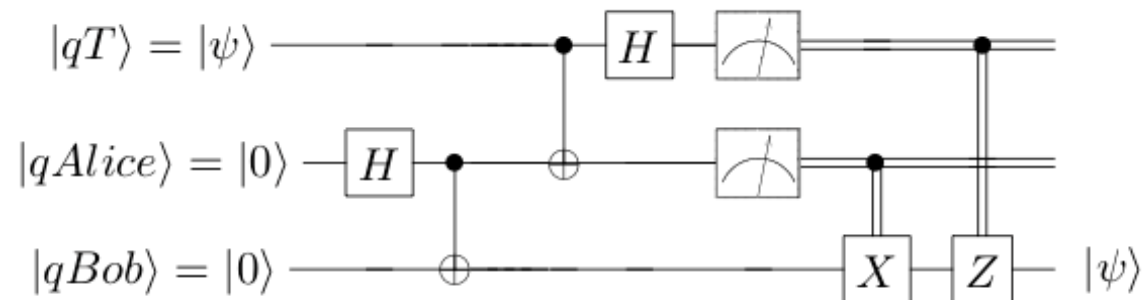

Fermilab quantum teleportation experiment (FQNET)

- Uses laser, attenuator, and arbitrary waveform generator to make time-binned optical photonic qubits
- Teleport the qubits over 40 km of commercial fiber
- Measure with SNSPDs = Superconducting Nanowire Single Photon Detectors

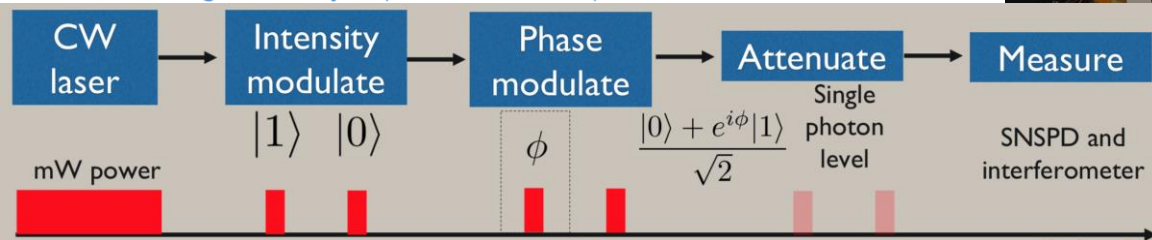
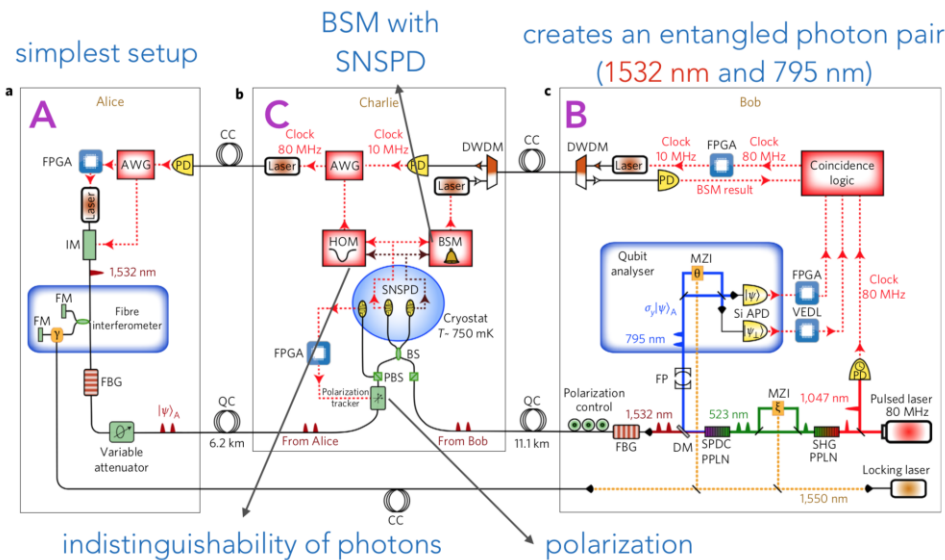

Fermilab quantum teleportation experiment (FQNET)

Through the INQNET research program and Caltech, AT&T supports the pilot quantum teleportation experiment at Fermilab

The Chicago Quantum Exchange is making plans with INQNET for establishing a quantum network testbed connecting Fermilab to Argonne.

John Donovan, CEO AT&T Communications



inqnet

Alliance for Quantum Technologies



Quantum teleportation through a wormhole

- It has been known for decades that the extended Schwarzschild geometry describes a pair of black holes connected via a **wormhole**, known as the **Einstein-Rosen (ER) bridge**.
- This wormhole is non-traversable, in the sense that anyone jumping into one black hole, and attempting to get to the horizon of the second black hole, instead ends up at the singularity.
- One can make a similar pair of black holes in Anti-de-Sitter space; in this case the AdS/CFT correspondence gives a powerful relation between the bulk gravitational physics and the physics of quantum entanglement

Penrose diagram of a pair of black holes connected by an ER bridge

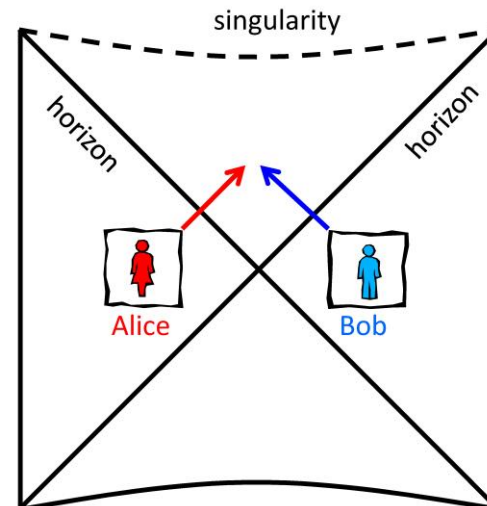

Quantum teleportation through a wormhole

- In 2016 Gao, Jafferis and Wall showed that the AdS version contains a **traversable wormhole** when perturbed in a simple way.
- Maldacena, Stanford and Yang have shown the required perturbation can be mapped into the standard operations of quantum teleportation.
- Thus, in this particular kind of semi-classical system, **quantum teleportation has an equivalent AdS/CFT description as a qubit physically moving through a wormhole.**

Maldacena and Susskind have speculated that **EPR = ER** in general, i.e. that quantum teleportation in general is some kind of “quantum wormhole”

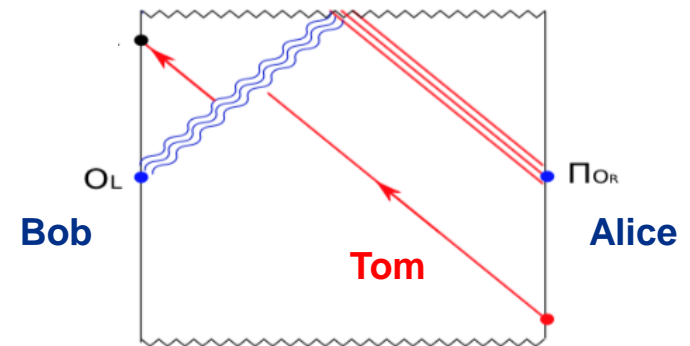

- P. Gao, D. Jafferis, A. Wall, “Traversable wormholes via a double trace deformation”, arXiv:1608.05687.
J. Maldacena and L. Susskind, “Cool horizons for entangled black holes”, arXiv:1306.0533.
J. Maldacena, D. Stanford, Z. Yang, “Diving into traversable wormholes”, arXiv:1704.05333.
L. Susskind and Y. Zhao, “Teleportation through the wormhole”, arXiv:1707.04354.

Quantum Information Science in DOE-SC

ASCR

Quantum algorithms; uncertainty quantification and verification & validation methods; software stack; quantum networks

BES

Synthesis, characterization, theory, modeling, and instrumentation to advance quantum materials & chemical phenomena

HEP

Black hole physics; quantum gravity and quantum error correction; fundamental aspects of entanglement

NP

Isotopes and trapped ions for quantum devices; lattice quantum chromodynamics

Quantum Field Theory and Topology

Control of Quantum Phenomena

▶ SC Unique Strengths

- ▶ Intellectual capital accumulated for more than a half-century
- ▶ Successful track record of forming interdisciplinary yet focused science teams for large-scale and long-term investments
- ▶ Demonstrated leadership in launching internationally-recognized SC-wide collaborative programs



HEP Engagement, Workshops, & Reports

- ▶ HEP has been working with the community, SC, and other agencies to identify its QIS connections since 2014, including participation in the NSTC Interagency Working Group
- ▶ Workshops and community reports inform program growth:
 - ▶ **Jan. 2015: ASCR-HEP** Study Group on “Grand Challenges at the Interface of Quantum Information Science, Particle Physics, and Computing”
 - ▶ **Feb. 2015: BES-HEP** Round Table Discussion on “Common Problems in Condensed Matter and High Energy Physics”
 - ▶ **Feb. 2016: HEP-ASCR** Roundtable on “Quantum Sensors at the Intersections of Fundamental Science, Quantum Information Science and Computing”
 - ▶ **July 2016: NSTC** report on “Advancing Quantum Information Science: National Challenges and Opportunities”
 - ▶ **Dec. 2017: APS/DPF** workshop on “Quantum Sensing for High Energy Physics” (report pending)



FY 2017 HEP Pilots in QIS

HEP has supported a number of modest pilot projects involving quantum information science in both National Laboratories and universities



Black hole information paradox pilot experiment (HEP/LBNL Norman Yao)

Simulated particle scattering off a complex boundary condition by quantum algorithms (HEP-ASCR/U Maryland Stephen Jordan)

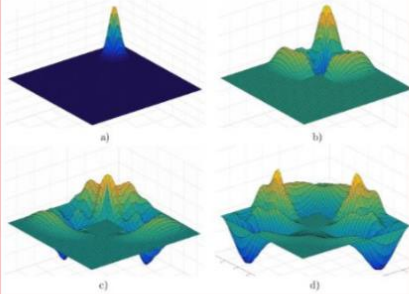

Quantum pattern recognition for real time data tracking & quantum algorithms for exponentially increased storage (HEP/LBNL Ilya Shapoval)

2025

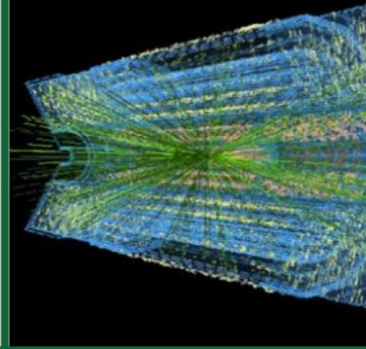

Quantum annealing for ML to separate signal/background in Higgs LHC data (HEP/Caltech-FNAL Maria Spiropulo) *published in Nature*

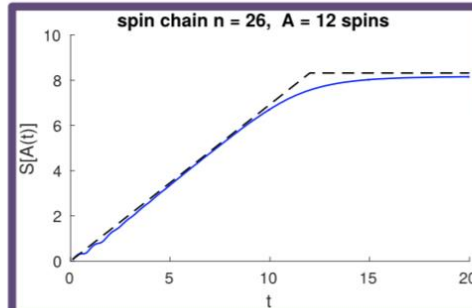

Entanglement & quantum chaos: toy models, holography, spin chains (HEP-BES/Princeton Juan Maldacena & Shivaji Sondhi)



How should the labs engage in the DOE SC initiative?

Fermilab is engaging in ways appropriate to our role as the main HEP lab:

- Focus on the science
- Find partners who already have leading quantum science expertise
- Exploit existing Fermilab expertise and infrastructure
- Leverage HEP resources with other funding streams
- Keep Fermilab activity aligned to HEP needs
- We are a gateway for the HEP community, so become an HEP hub for quantum science
- Produce high impact science results in the near term, while also building capacity for HEP needs in the long term

Fermilab quantum collaborations

Collaborations are for non-proprietary basic research in quantum science. Strategy is to engage with major U.S.-based companies, other labs, and university groups already expert in QIS.



Conclusions

- Quantum technology is developing fast
- The community of scientists engaged in advancing or applying these technologies is also growing fast and becoming broader
- But patience and a long view will be required



Quantum simulations?

We need to start with something simple!



Figure: Mike Creutz's calculator used for a Z_2 gauge theory on a 3^4 lattice (circa 1979).

