



U.S. DEPARTMENT OF
ENERGY

Office of
Science

FY 2013 Budget Request to Congress for DOE's Office of Science

March 27, 2012

Dr. W. F. Brinkman
Director, Office of Science
U.S. Department of Energy
www.science.energy.gov

Office of Science

Science to Meet the Nation's Challenges Today and into the 21st Century

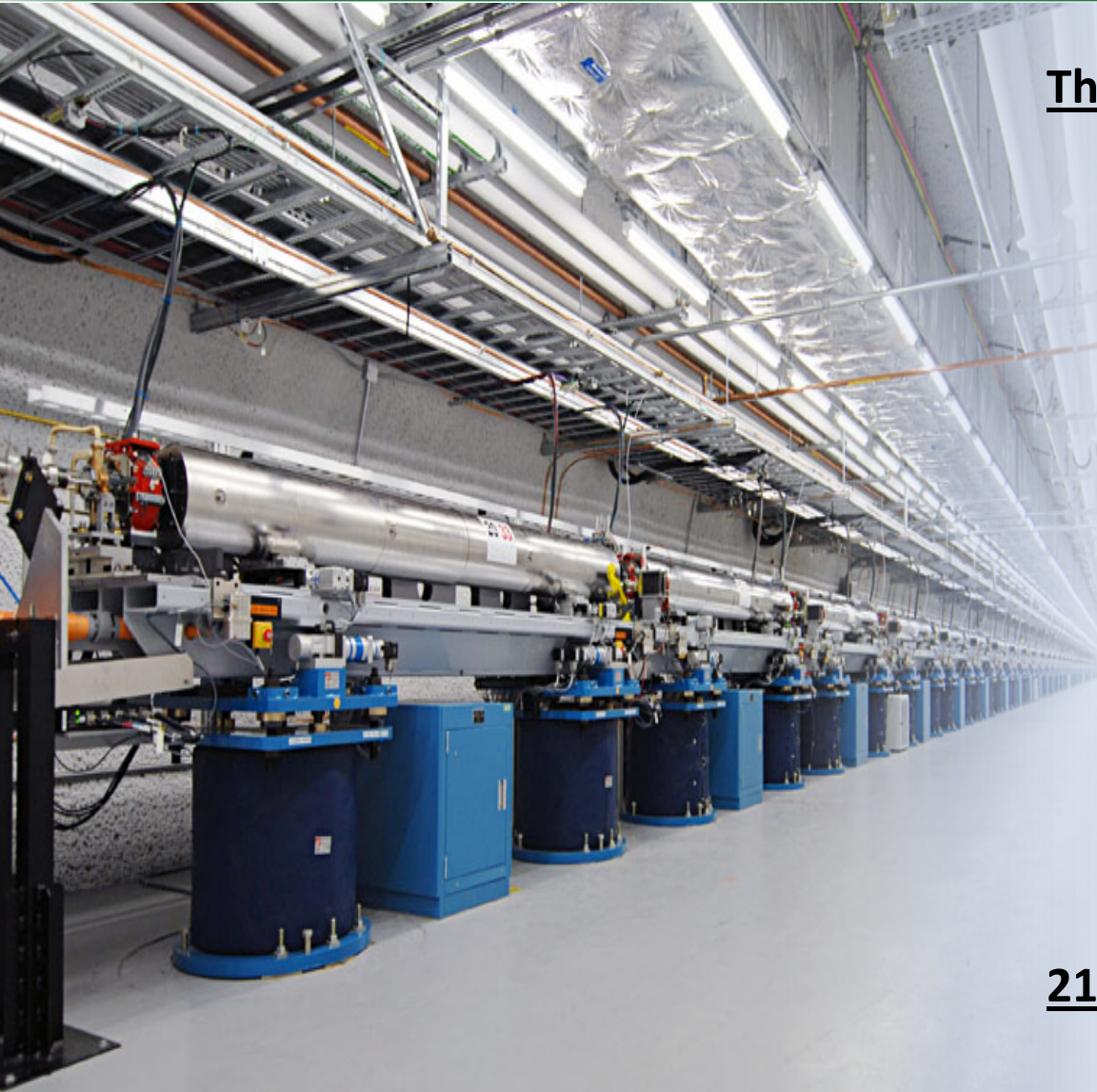

The Frontiers of Science

- Supporting research that led to over **100 Nobel Prizes** during the past **6 decades**—more than **20** in the past **10 years**
- Providing **45%** of Federal support of basic research in the physical and energy related sciences and key components of the Nation's basic research in biology and computing
- Supporting over **25,000 Ph.D.** scientists, graduate students, undergraduates, engineers, and support staff at more than **300** institutions

21st Century Tools of Science

- Providing the world's largest collection of scientific user facilities to over **26,500** users each year

“Innovation is what America has always been about.”



Remarks of President Barack Obama
State of the Union Address to the Joint Session of Congress
Tuesday, January 24, 2012

“Innovation ... demands basic research.Don't gut these investments in our budget. Don't let other countries win the race for the future. Support the same kind of research and innovation that led to the computer chip and the Internet; to new American jobs and new American industries.

Nowhere is the promise of innovation greater than in American-made energy.”



Science, Innovation, and DOE's Office of Science

- Science is the basis of technology and underpins America's energy future.
- Science of the 20th century brought us the high standard of living we now enjoy. Today, we are laying the foundations for the new technologies of the coming decades.
- Progress in science and technology depends on continuing advances in, and replenishment from, basic research, where the federal government—and SC—plays a unique role.
- A highly trained work force is required to invent the future—scientists and engineers trained in the most modern science and technologies and with access to the best tools.



Office of Science Research Underpins the President's Goals

- The Office of Science commands an arsenal of basic science capabilities—major scientific user facilities, national laboratories, and researchers—that we are using to break down the barriers to new energy technologies.
- We have focused these capabilities on critical national needs, e.g., through the Bioenergy Research Centers, the Energy Frontier Research Centers, the Combustion Research Facility, the Joint Genome Institute, the five Nanoscience Centers, and the new Energy Innovation Hubs.

Science for Innovation and Clean Energy

Applications of 21st century science to long-standing barriers in energy technologies: employing nanotechnology, biotechnology, and modeling and simulation:

- **Materials and chemical processes by design** using nanoscale and mesoscale structures for scientific advances and manufacturing innovations in solar energy conversion; clean-energy electricity generation; battery and vehicle transportation; and carbon capture, use, and sequestration.
- **Biosystems by design** targeting the development of synthetic biology tools and technologies and integrative analysis of experimental genomic science datasets for the design and construction of improved biofuels and bioproducts.
- **Modeling and simulation** using SC's Leadership Computing Facilities and production computing facilities to advance materials and chemistry by design and to broadly address energy technology challenges.

Materials and Chemistry by Design

Accelerating Discovery for Global Competitiveness

- Research to establish design rules to launch an era of predictive modeling, changing the paradigm of materials discovery to rational design.
 - New software tools and data standards to catalyze a fully integrated approach from material discovery to applications
- Discovery of new materials has been the engine driving science frontiers and fueling technology innovations. Research would utilize the powerful suite of tools for materials synthesis, characterization, and simulation at DOE's world-leading user facilities
- Integrated teams to focus on key scientific knowledge gaps to develop new theoretical models
 - Long-term: realization in reusable and broadly-disseminated software
 - Collection of validated experimental and modeling data for broader community use

Prediction: New battery materials starting from first principles theory

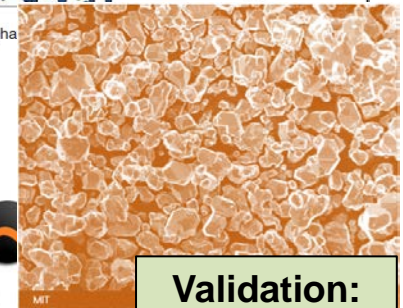
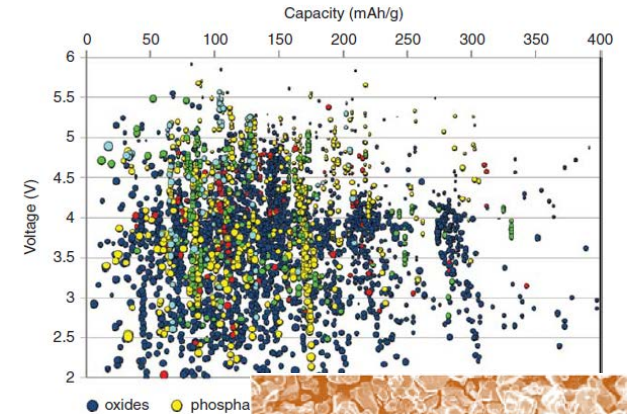

Validation:
Materials
fabrication



<http://materialsproject.org/>

End Use: Software on-line for
general community use

Science for Clean Energy: Biosystems by Design

Research to establish biological design rules will enable the predictive design of innovative natural and hybrid systems for clean energy production.

Discovery and synthetic redesign of plant and microbial systems advances science understanding and paves the way for sustainable production of biofuels and bioproducts.

Research areas of emphasis:

- **Biosystems by Design**
 - New synthetic biology methods—genome-scale engineering of plants and microbes
 - New genetic toolkits
 - Development of functional modules and platform organisms
 - Predictive integration of components and processes
 - Verify & validate computer-aided design toolkits
 - New testbeds to prototype performance and function

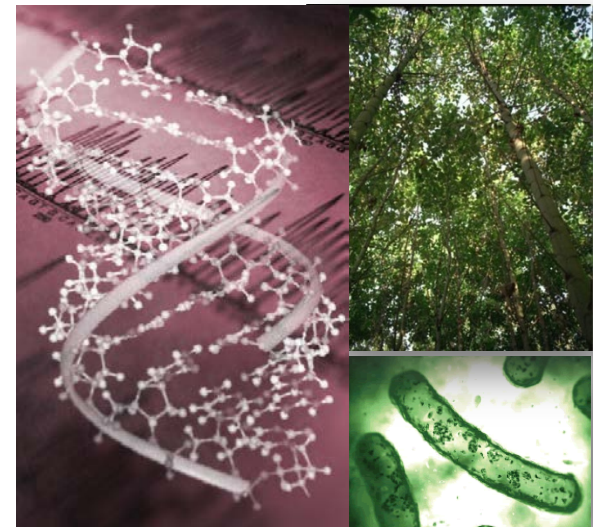
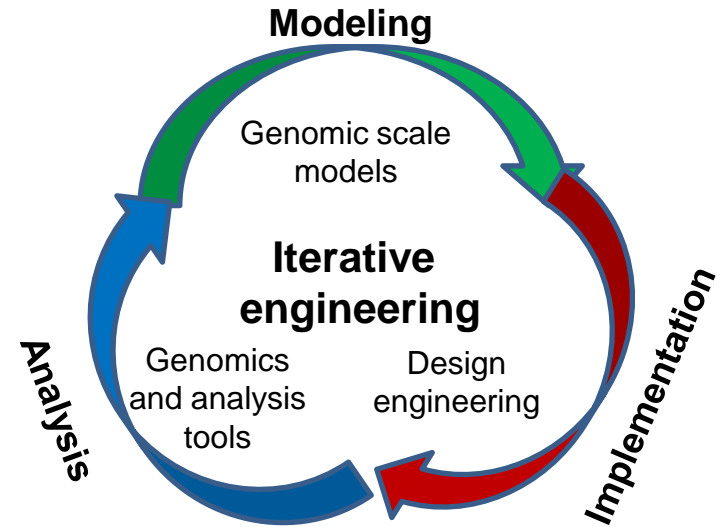

Office of Science FY 2013 Budget Request to Congress

	FY 2011 Current Approp.	FY 2012 Current Approp.	FY 2013 President's Request	FY 2013 Request vs FY 2012
Advanced Scientific Computing Research	410,317	440,868	455,593	+14,725
Basic Energy Sciences	1,638,511	1,688,093	1,799,592	+111,499
Biological and Environmental Research	595,246	609,557	625,347	+15,790
Fusion Energy Sciences	367,257	400,996	398,324	-2,672
High Energy Physics	775,578	790,860	776,521	-14,339
Nuclear Physics	527,684	547,387	526,938	-20,449
Workforce Development for Teachers and Scientists	22,600	18,500	14,500	-4,000
Science Laboratories Infrastructure	125,748	111,800	117,790	+5,990
Safeguards and Security	83,786	80,573	84,000	+3,427
Program Direction	202,520	185,000	202,551	+17,551
Subtotal, Office of Science	4,749,247	4,873,634	5,001,156	+127,522
Other	148,036	...	-9,104	-9,104
Total, Office of Science	4,897,283	4,873,634	4,992,052	+118,418





U.S. DEPARTMENT OF
ENERGY

Office of
Science

Program Details

Advanced Scientific Computing Research

Delivering world leading computational and networking capabilities to extend the frontiers of science and technology

The Scientific Challenges:

- Deliver next-generation scientific and energy applications on multi-petaflop computers.
- Discover, develop, and deploy exascale computing and networking capabilities.
- Partner with U.S. industry to develop the next generation computing hardware and tools for science.
- Discover new applied mathematics, computer science, and networking tools for the ultra-low power, multicore-computing future and data-intensive science.
- Provide technological innovations for U.S. leadership in Information Technology to advance competitiveness.

FY 2013 Highlights:

- Co-design centers to deliver next generation scientific applications.
- Investments with U.S. industry to address critical challenges on the path to exascale.
- Operation of a 10 petaflop low-power IBM Blue Gene/Q at the Argonne Leadership Computing Facility and installation and early science access to a 10-petaflop, hybrid, multi-core computer at the Oak Ridge Leadership Computing Facility.
- Research efforts across the portfolio in support of data-intensive science including the massive data produced by Scientific User Facilities.

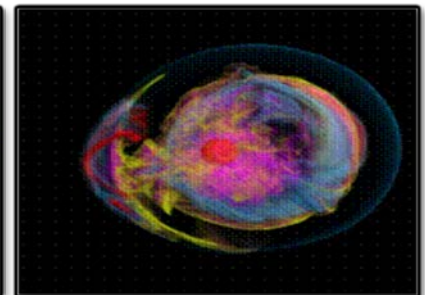
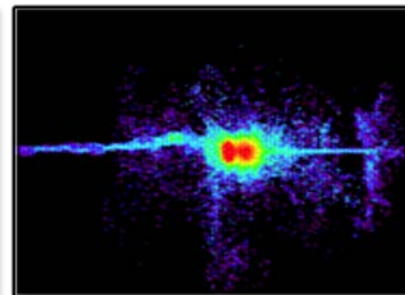
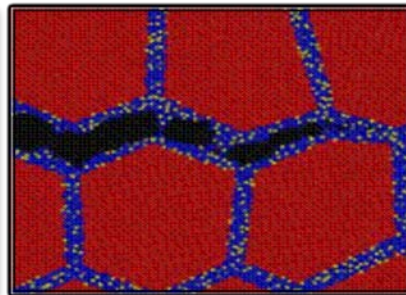
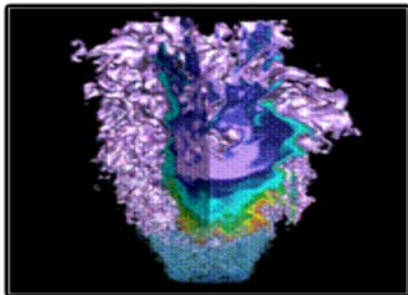

INCITE Computing Contributes to U.S. Competitiveness and Clean Energy



- **GE** determined the effects of unsteady flow interactions between blade rows on the efficiency of turbines.
 - Provided engineers with the analytical tools to extract greater design efficiency and fuel savings.
 - Results provided substantial ROI justification for GE to purchase its own Cray supercomputer



- **Ramgen** used computational fluid dynamics with shock compression to expedite design-cycle analysis.
 - Accelerated the development of the CO₂ compressor allowing Ramgen to go from computer design and testing to cutting a Titanium prototype in 2 months.

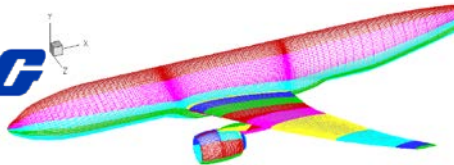

- **Boeing** demonstrated the effectiveness and accuracy of computational fluid dynamics simulation tools and used them in designing their next generation of aircraft.
 - Significantly reduced the need for prototyping and wind tunnel testing.



- **GM** accelerated materials research by at least a year to help meet fuel economy and emissions standards.
 - A prototype thermoelectric generator in a Chevy Suburban generated up to 5% improvement in fuel economy.

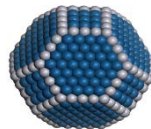

- **United Technologies** studies of nickel and platinum are demonstrating that the less expensive nickel can be used as a catalyst to produce hydrogen.

Investments for Exascale Computing

Addressing Critical Challenges to Deliver Predictive Science and Engineering

Challenges of Exascale

DOE must invest in partnerships and research to address the challenges of emerging hardware to maintain our world-leading position.

- Reduce power requirements by a factor of 10.
- Improve reliability so that hardware operates effectively through component failures.
- Develop tools and techniques to make these advanced systems easier to use.

Broad Impacts

Computation and simulation advance knowledge in science, energy, and national security; numerous S&T communities and Federal Advisory groups have demonstrated the need for computing power 1,000 times greater than we have today.

The program will:

Advance all DOE missions

- DOE missions include challenges for which experiments are too risky or expensive to pursue. Exascale capabilities will deliver an new level of precision and predictability to these efforts.

Drive innovation

- Achieving the power efficiency, reliability, and programmability goals essential for exascale will have enormous impact on business information technology, scientific computing, and engineering design at all scales.

Build on our successes

- DOE is the U.S. leader in delivering extreme scale science and engineering applications on state-of-the-art hardware.

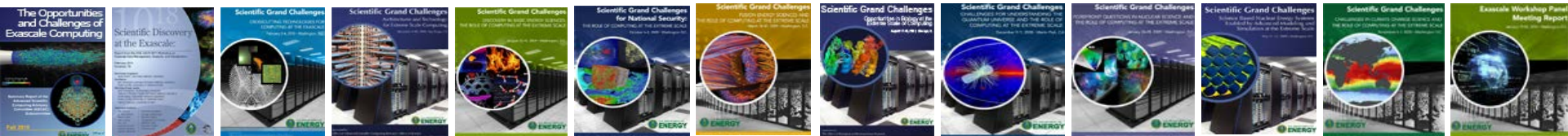

Basic Energy Sciences

Understanding, predicting, and ultimately controlling matter and energy flow at the electronic, atomic, and molecular levels

The Scientific Challenges:

- Synthesize, atom by atom, new forms of matter with tailored properties, including nano-scale objects.
- Direct and control matter and energy flow in materials and chemical assemblies over multiple length and time scales.
- Explore materials functionalities and their connections to atomic, molecular, and electronic structures.
- Explore basic research to achieve transformational discoveries for energy technologies.

FY 2013 Highlights:

- Science for clean energy
 - Science-based chemical and materials discovery to enable manufacturing innovations
 - R&D for next-generation clean energy applications jointly funded with EERE
- Materials and chemistry by design: discovery grounded in theory and modeling
- National Synchrotron Light Source-II construction and early operations
- User facilities at near optimum operations; facility upgrades and enhancements
 - LCLS expansion (LCLS-II); NSLS-II EXperimental Tools (NEXT); APS Upgrade (APS-U)

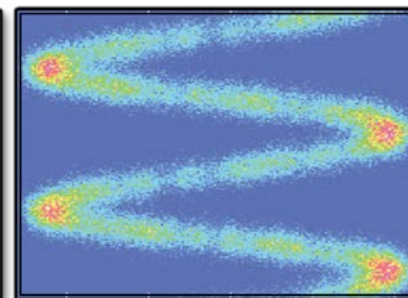
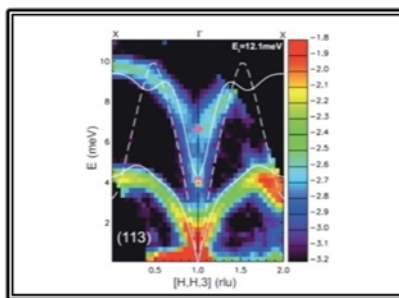
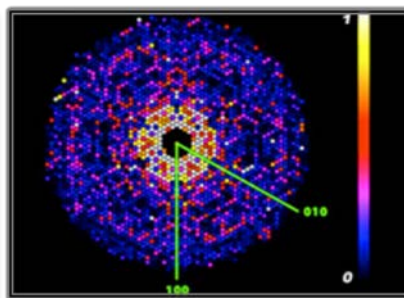
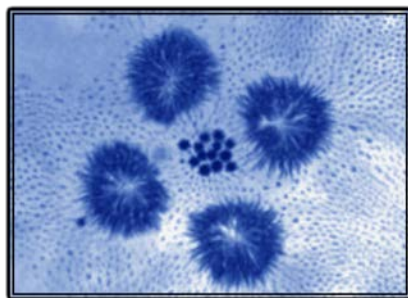

Energy Frontier Research Centers

46 EFRCs in 35 States were launched in Fall 2009

- ~**860** senior investigators and ~**2,000** students, postdoctoral fellows, and technical staff at ~**115** institutions
- > **250** scientific advisory board members from **12** countries and > **35** companies

Impact to date:

- >**1,000** peer-reviewed papers including more than **30** publications in *Science* and *Nature*.
- > **40** patents applications and nearly **50** additional patent/invention disclosures by **28** of the EFRCs.
- at least **3** start-up companies with EFRC contributions

Assessment of progress:

- All EFRCs are undergoing mid-term peer review to assess progress towards goals and plans for the next 2 years of R&D.

FY 2013 plans:

- Enhanced integration with DOE Technology programs to ensure implementation of scientific advances

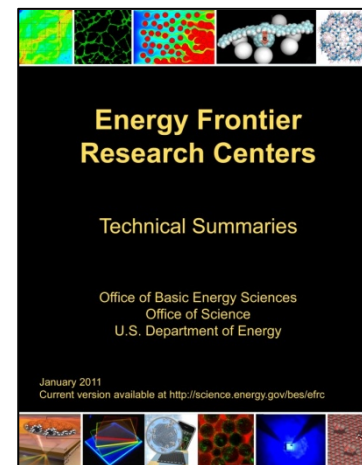

<http://science.energy.gov/bes/efrc/>

Materials by Design: Light absorption in wire arrays

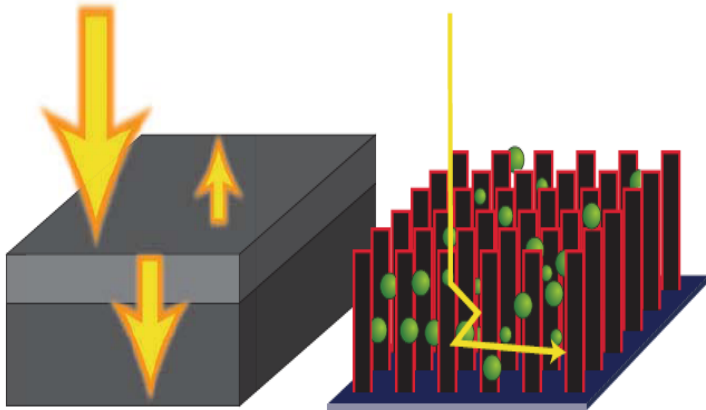

Al_2O_3 nanoparticles reflect light towards Si wire arrays



SiN_x antireflective coating

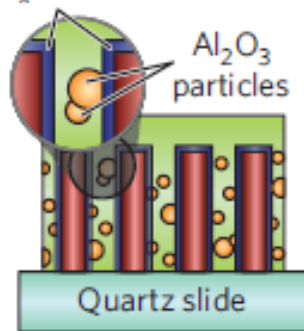

- Assembly on a reflective backing
 - Light absorbing nanowires surrounded by polymer that contains Al_2O_3 scattering particles
- Wire arrays can absorb just as much sunlight as a conventional PV cell, but with only 2% of the Si
 - Silicon wires fill as little as 2% of the cell's volume and absorb up to 85% of the sunlight
- More than 90% of the absorbed light generates electricity rather than heat
- Flexible arrays are inexpensive to make
- Impact from this work
 - 2010 Popular Mechanics Breakthrough Award
 - *Caelux* – a DOE-supported & venture-backed start-up company

Research supported by the Light-Material Interactions in Energy Conversion EFRC led by Caltech and featured as an SC [Story of Discovery & Innovation](#) on 7/7/2011.

Nature Materials, **9**, 239 (2010).



U.S. DEPARTMENT OF
ENERGY

Office of
Science



Berkeley
University of California



Fuels from Sunlight Hub: Project Update

- Space:
 - The Joint Center for Artificial Photosynthesis (JCAP) North (LBNL) occupies 14,000 sq. ft. leased space.
 - JCAP South (Caltech) occupies temporary space; renovation of permanent space complete May 2012.
- Staffing: Staffing ongoing at all levels (senior staff, postdocs, students).
- Equipment: Equipment acquisitions on schedule.
- Output: Several scientific publications and invention disclosures.
- Oversight:
 - BES conducted a management/operations review of JCAP in April, 2011. JCAP on track with no major issues.
 - BES will conduct an onsite scientific and technical review in spring 2012.
- Collaboration:
 - JCAP hosted *Artificial Photosynthesis Futures Meeting* to formulate collaborations with EFRCs and demonstrate new lab capabilities at JCAP North.

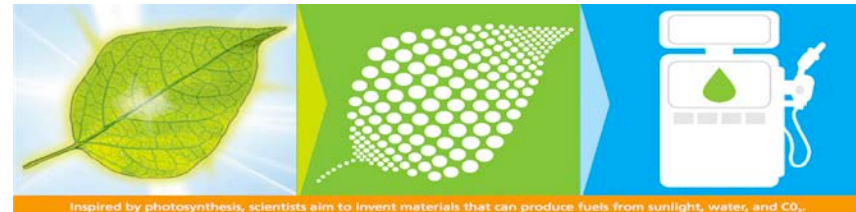

U.S. DEPARTMENT OF
ENERGY

Office of
Science



Maintaining World Leadership in Light Sources

Upgrades and Instrumentation

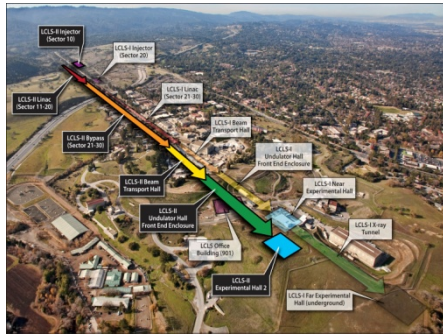

Linac Coherent Light Source-II (LCLS-II)

- LCLS-II will provide a second, independently controlled FEL to the facility
- Expanded x-ray energy range (250eV - 13keV), x-ray polarization control, control pulse length down to ~1 femtosecond
- New experimental hall with 4 experimental stations
- Cost Range: \$350M - \$500M (Line Item Construction)
- FY 2012 \$30M, FY 2013 Request \$64M for R&D, design, and construction



Advanced Photon Source Upgrade (APS-U)

- Temporal resolution to 1 picosecond, spatial resolution <1 nm above 25 keV
- Accelerator and x-ray source upgrades, new and upgraded beamlines, enabling technical capabilities
- Cost Range: \$310M - \$450M (Major Item of Equipment)
- FY 2012 \$20M, FY 2013 Request \$20M for R&D, design, and long lead procurement

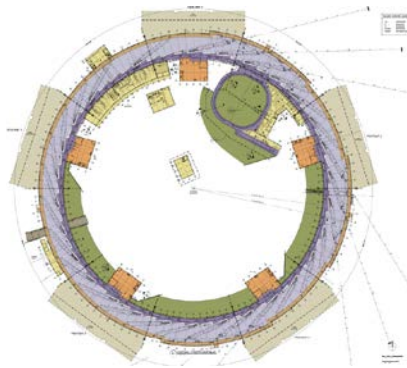

NSLS-II Experiment Tools (NEXT)

- Enhance NSLS-II with 4 to 6 best-in-class beamlines chosen from peer reviewed proposals
- Beamlines will support 300-400 users per year
- Cost Range: \$83M - \$90M (Major Item of Equipment)
- FY 2012 \$12M, FY 2013 Request \$12M for R&D, design, long lead procurement, and construction

Fortune 500 Users of BES Scientific Facilities

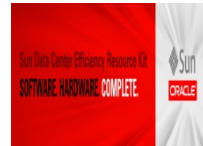

U.S. DEPARTMENT OF
ENERGY

Office of
Science

Biological and Environmental Research

Understanding complex biological, climatic, and environmental systems across vast spatial and temporal scales

The Scientific Challenges:

- Understand how genomic information is translated with confidence to redesign microbes, plants or ecosystems for improved carbon storage, contaminant remediation, and sustainable biofuel production
- Understand the roles of Earth's biogeochemical systems (atmosphere, land, oceans, sea ice, subsurface) in determining climate so we can predict climate decades or centuries into the future, information needed to plan for future energy and resource needs.

FY 2013 Highlights:

- Clean energy biodesign on plant and microbial systems through development of new molecular toolkits for systems and synthetic biology research.
- Continue support for the Bioenergy Research Centers, the Joint Genome Institute, the Environmental Molecular Sciences Laboratory, and the Atmospheric Radiation Measurement Climate Research Facility.
- Research and new capabilities to develop comprehensive environmental system models in the Arctic and tropics, regions especially vulnerable to rapid climate change.

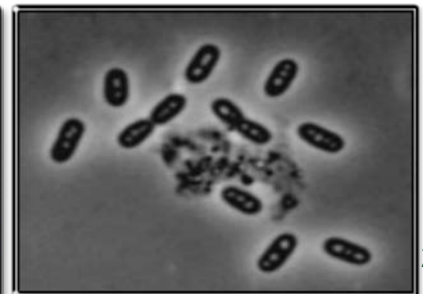
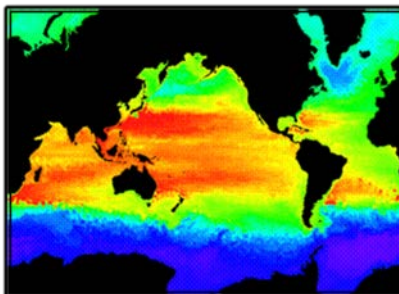
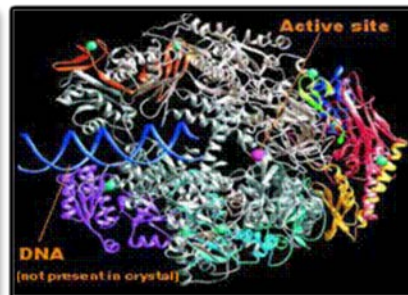
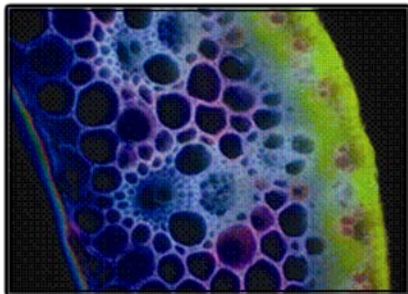

Advancing Energy Technologies through Bioenergy Research



- Identified key lignin biosynthesis genes in switchgrass, providing potential targets for improving switchgrass as a bioenergy crop.
- Used synthetic biology toolkit to construct the first microbes to produce either drop-in biofuels or jet fuel precursors from switchgrass.
- Analyzed field trial data showing that crop selection and soil management practices have a strong impact on greenhouse gas emission and carbon storage, informing sustainable land management strategies for producing bioenergy crop systems.

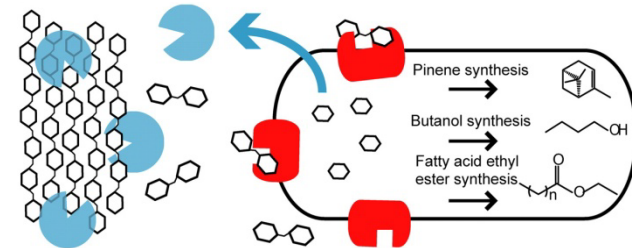
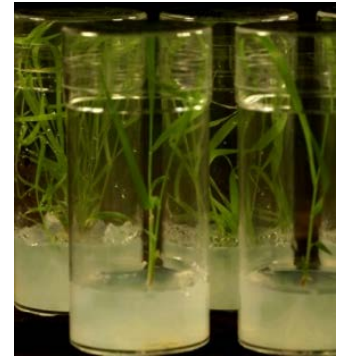

The Joint Genome Institute—Leader in Metagenomics

- Metagenomics is the sequencing of genomes from a community of organisms rather than from a single isolate. Most microbes found in nature exist in complex, inter-dependent communities; metagenomic technologies enable elucidation of their collective function.
- The Joint Genome Institute has been a leader in the development of metagenomic technologies and large-scale genome sequencing for environmental samples
- Microbial carbon cycling in Arctic permafrost
 - Reconstructed whole genome of a novel and abundant, methane-producing microbe from an Arctic permafrost metagenome.
 - Genomic information can inform studies of the effects of warming conditions on the estimated 1.6 trillion metric tons of permafrost sequestered carbon, more than 250 times the amount of greenhouse gas emissions attributed to the United States in 2009.



DOE Provides End-to-End Contributions for the International Panel on Climate Change (IPCC) Fifth Assessment Report (AR5)

- Emissions: the base-line central estimate future emission scenario
- Community Earth System Model DOE-funded major upgrades include:
 - Community Land Model, terrestrial carbon
 - Atmospheric aerosols, fast chemistry
 - Sea-ice and land-ice
 - Ocean
- Program for Climate Model Diagnostics and Intercomparison: provides data archive, diagnostics, analysis, and software tools to the international community, using the Earth System Grid portal
- Authors: DOE funds the research of 25 of the AR5 IPCC lead and editorial authors, contributes as lead author on Radiative Forcing chapter.

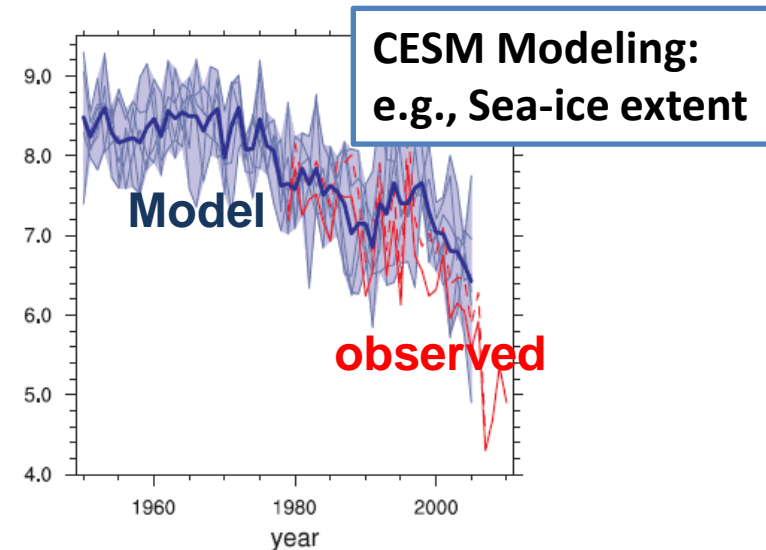
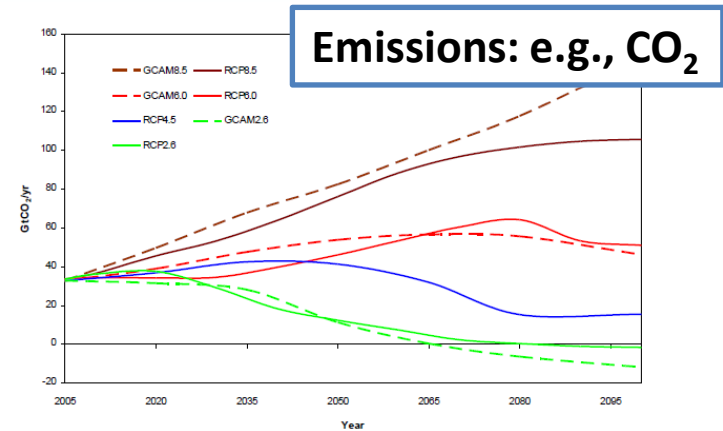

Diagnostics

Key Partnerships with Other Federal Agencies

- **Coordination of Climate Research through the United States Global Change Research Program (USGCRP).**
 - Flexible, integrated, robust, and responsive enterprise, organized around cross cutting themes, that draws on the unique attributes and expertise of Federal agencies to advance the knowledge needed to inform adaptation and mitigation policy and activities.
 - **Significant contributions of lead agencies**
 - NASA: Climate observations using space assets
 - NOAA: Climate measurements and modeling in support of public safety
 - **DOE: Climate research in support of future energy decisions**
 - NSF: Climate research in support of national scientific capacity and innovation
- **Joint USDA-DOE Plant Feedstock Genomics for Bioenergy**
 - Competitive merit-based program with USDA-National Institute of Food and Agriculture
 - Leveraging DOE genomics expertise with USDA stewardship of public breeding programs to develop bioenergy crops



United States Department of Agriculture
National Institute of Food and Agriculture

Fusion Energy Sciences

Understanding matter at very high temperatures and densities and building the scientific foundations for a fusion energy source

The Scientific Challenges:

- Control a burning plasma state to form the basis for fusion energy.
- Develop materials that can withstand the harsh heat and neutron irradiation in fusion facilities.
- Manipulate and control intense transient flows of energy and particles.
- Control the interaction of matter under extreme conditions for enabling practical inertial fusion energy.

FY 2013 Highlights:

- ITER construction is advancing.
- DIII-D investigates predictive science for ITER; NSTX undergoes performance upgrade; and Alcator C-Mod is closed.
- Matter in Extreme Condition Instrument begins operation at LCLS to study high-energy-density laboratory physics.
- New SciDAC high-performance computing projects are selected, in partnership with ASCR, to advance scientific discovery.
- International activities on experiments with world-leading technologies are increased.
- Fusion materials research is enhanced.

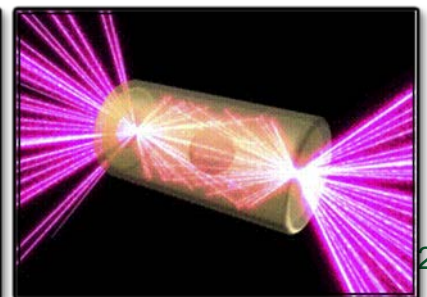
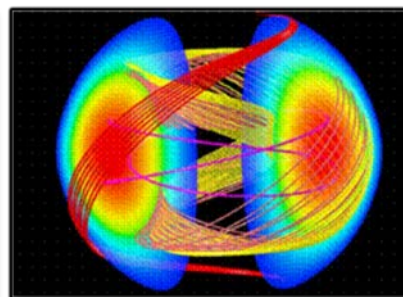
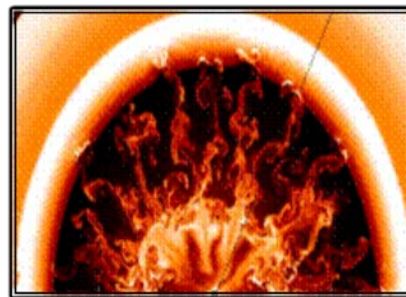
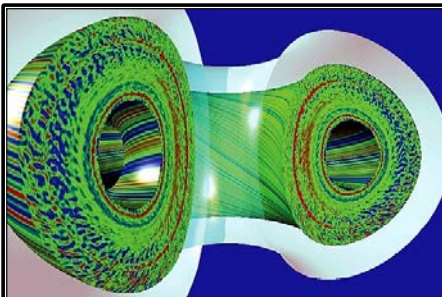

Progress on the ITER Project

Construction is well underway.

- All ITER Members show a strong commitment to completion of the ITER project. The EU has committed 2B Euros for the next two years; Japan funding triples for FY 2012.
- The new leadership team, including U.S. participation at the highest levels, has streamlined operations, reduced costs, and maintained schedule despite challenges such as the Japanese earthquake.

Among the "standing soldiers" at the bottom of the Tokamak Pit, it's easy to distinguish the future location of the machine by the spokes that branch out from a central plinth (January 2012).



Precise and careful alignment for Seismic Pad #100: Early November 2011, workers completed the installation of seismic pad number 100.



U.S. Funding for ITER

U.S. jobs, high-tech U.S. manufacturing, industry funding from ITER overseas partners

80% of US funds for ITER are spent in the US

Funding in FY 2012 of \$105M will:

- Support jobs in >300 industries and universities and 8 National Labs in 37 states
- Provide US industry experience with advanced manufacturing techniques

Funding to DOE Labs

March 2006 – December 2011

Total ~\$168M



Funding to Industries and Universities

March 2006 – December 2011

Total ~\$153M

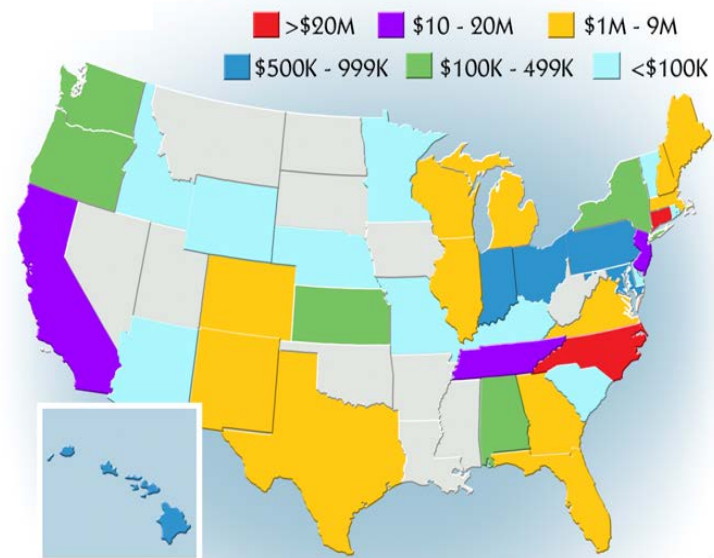

US ITER Future Contracts ~\$1B



U.S. DEPARTMENT OF
ENERGY

Office of
Science

NSTX Upgrades Provide World-Leading Capability

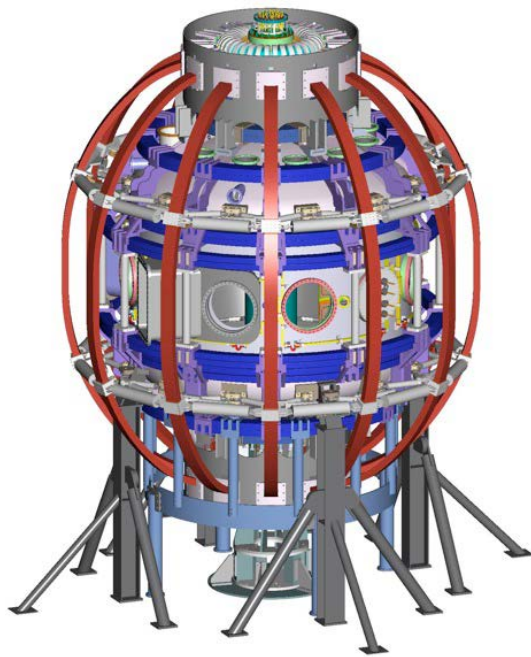

The completed NSTX

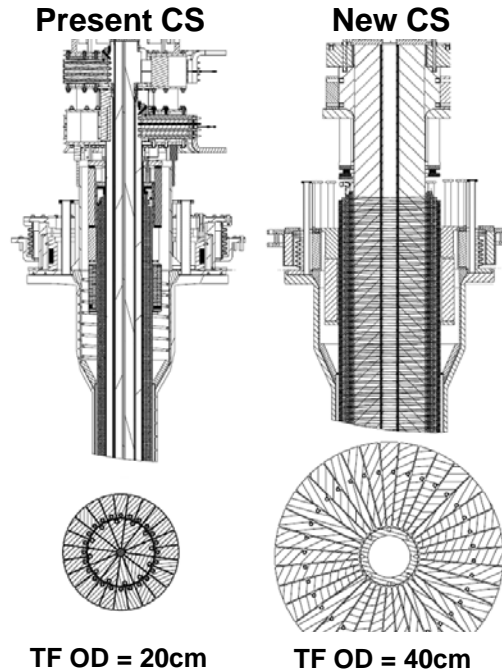

Center-stack magnets

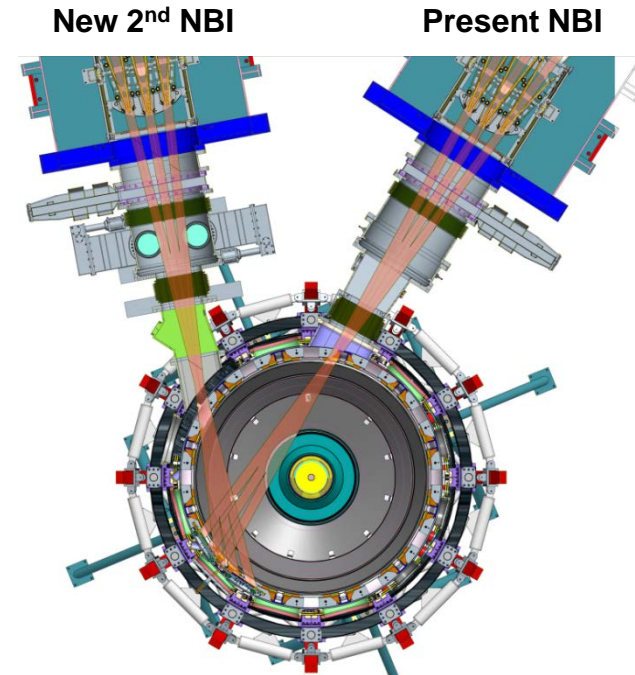

Neutral-beam capabilities

- Upgrade will provide world-leading capability for this configuration.
- Goal: assess the viability of this aggressive, compact tokamak geometry as a fusion neutron source for testing fusion materials and components
 - Double capacity in the magnets and heating → increase pulse length by 5x; increase temperature; drive up to 100% of the current without a central solenoid

Nuclear Physics

Discovering, exploring, and understanding all forms of nuclear matter

The Scientific Challenges:

Understand:

- The existence and properties of nuclear matter under extreme conditions, including that which existed at the beginning of the universe
- The exotic and excited bound states of quarks and gluons, including new tests of the Standard Model
- The ultimate limits of existence of bound systems of protons and neutrons
- Nuclear processes that power stars and supernovae, and synthesize the elements
- The nature and fundamental properties of neutrinos and neutrons and their role in the matter-antimatter asymmetry of the universe

FY 2013 Highlights:

- Operations and research at three nuclear science user facilities (RHIC, CEBAF, ATLAS)
- 12 GeV CEBAF Upgrade to study systems of quarks and gluons and the force that creates protons and neutrons.
- Continued preparation for construction of the Facility for Rare Isotope Beams to study the limits of nuclear existence.
- Research, development, and production of stable and radioactive isotopes for science, medicine, industry, and national security.
- New strategic planning activity begins in FY 2012.

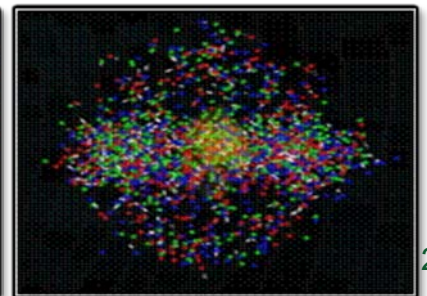
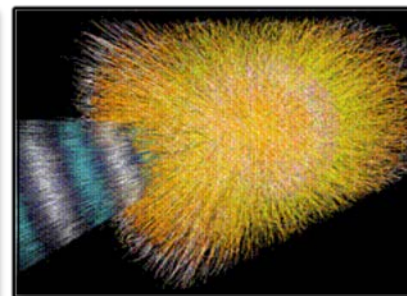
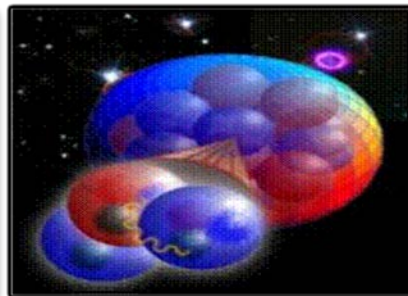
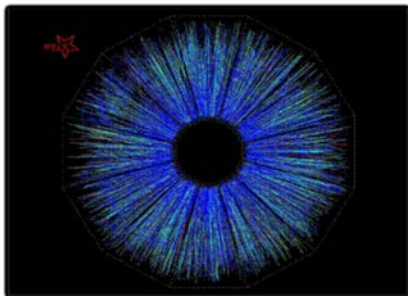

Heaviest Anti-Nucleus Ever Observed Discovered at RHIC



Third in the Discover Magazine Top Ten Physics and Math Stories for 2011: “Helium’s Anti-Matter Twin Created”

Against one in 28 billion odds, two anti-protons and two anti-neutrons combine in RHIC collisions to form anti-helium 4, the heaviest anti-nucleus ever observed.

The graph below shows particle counts by mass, showing ordinary helium nuclei (He-3 and He-4) in orange, and their antimatter counterparts (antihelium-3 and antihelium-4) in blue. The newly discovered antimatter nuclei, antihelium-4, are clearly separated from the lighter isotopes, and are at the correct mass.

This discovery (*Nature* **473** (2011) 353) shows that complex anti-nuclei will form if enough anti-protons and anti-neutrons are present.

It underscores a grand challenge question of modern science: what process in the early universe resulted in more matter than anti-matter being present today?

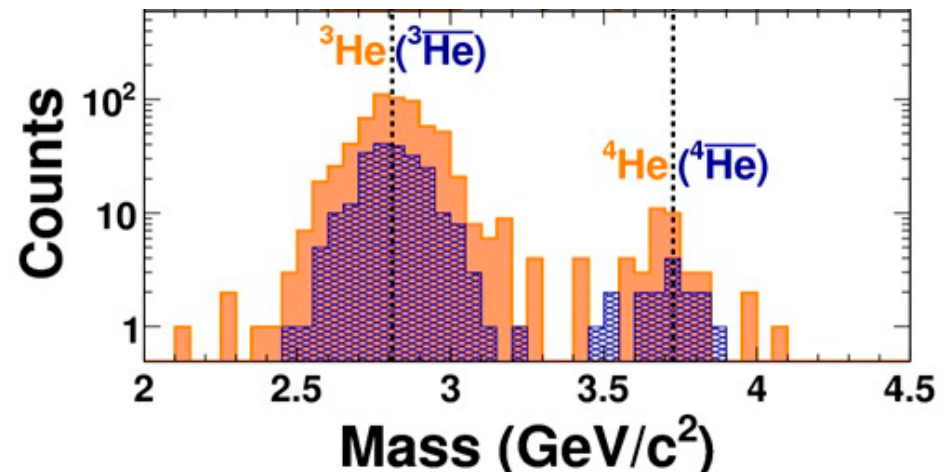

The 12 GeV CEBAF Upgrade at TJNAF 60% Complete.

With the completion of the 12 GeV CEBAF Upgrade, researchers will address:

- The search for exotic new quark-anti-quark particles to advance our understanding of the strong force
- Evidence of new physics from sensitive searches for violations of nature's fundamental symmetries
- A detailed microscopic understanding of the internal structure of the proton, including the origin of its spin, and how this structure is modified when the proton is inside a nucleus

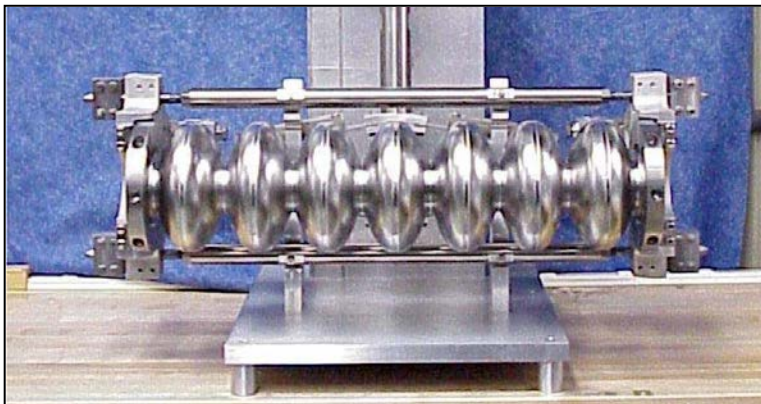

Main Elements of the 12 GeV CEBAF Upgrade

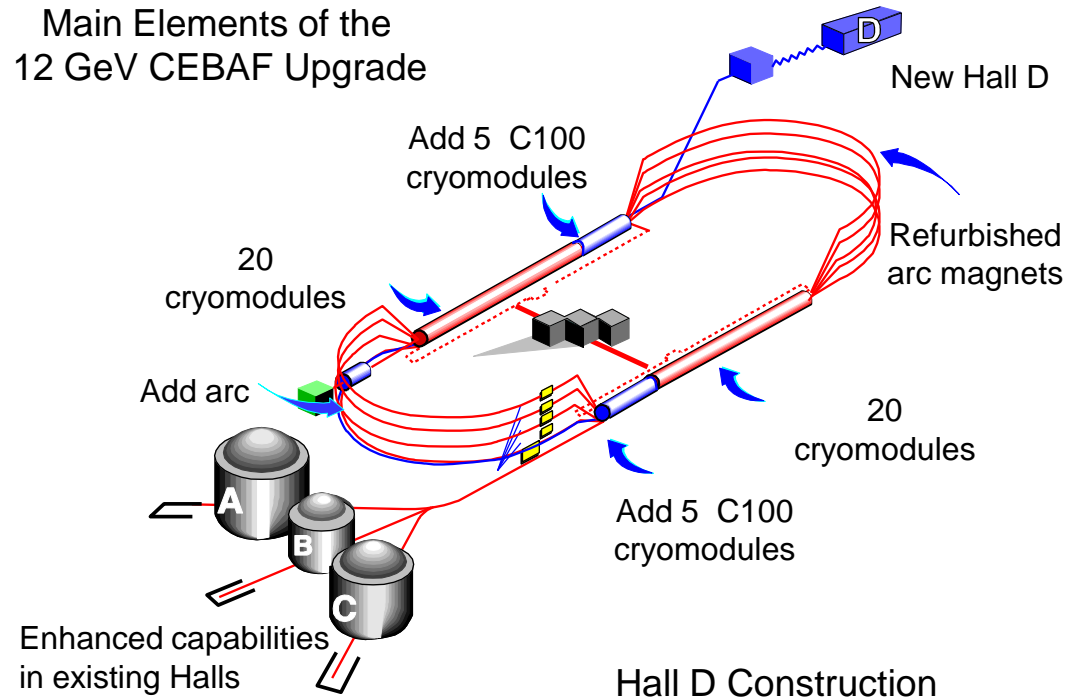

A photograph of one of the superconducting radio frequency (SRF) cavities developed and constructed at Thomas Jefferson National Laboratory (TJNAF) to increase the energy of the CEBAF electron beam. There are eight such cavities in each of the ten C100 cryomodules installed as part of the 12 GeV CEBAF Upgrade (above schematic)

Preparations for Construction of Facility for Rare Isotope Beams

Existing National Superconducting Cyclotron Laboratory



New FRIB Linear Accelerator

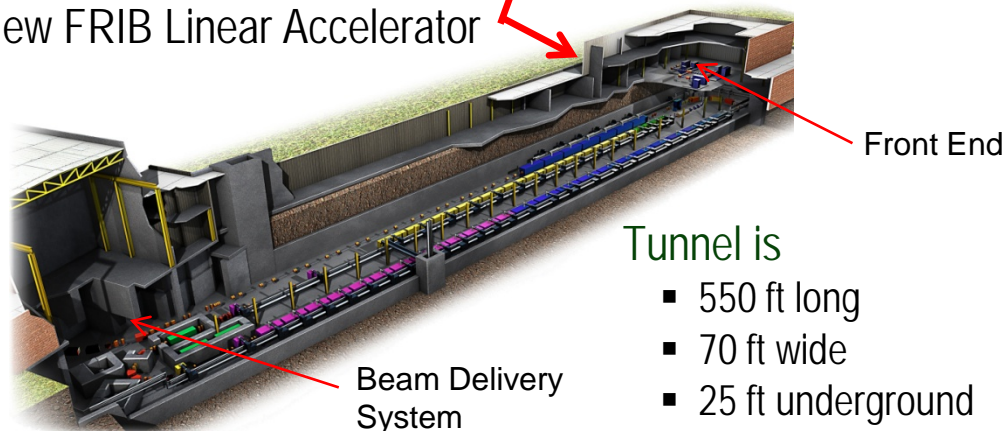

Tunnel is

- 550 ft long
- 70 ft wide
- 25 ft underground

FRIB will increase the number of isotopes with known properties from ~2,000 observed over the last century to ~5,000 and will provide world-leading capabilities for research on:

Nuclear Structure

- The ultimate limits of existence for nuclei
- Nuclei which have neutron skins
- The synthesis of super heavy elements

Nuclear Astrophysics

- The origin of the heavy elements and explosive nucleo-synthesis
- Composition of neutron star crusts

Fundamental Symmetries

- Tests of fundamental symmetries, Atomic EDMs, Weak Charge

This research will provide the basis for a model of nuclei and how they interact.



Isotopes and Radioisotopes in Short Supply Provided at Full Cost Recovery by the Office of Science to Support U.S. Needs and Industrial Competitiveness

Some key isotopes and radioisotopes and the companies that use them

Strontium-82, Rubidium-82	Imaging / Diagnostic cardiology
Germanium-68, Gallium-68	Calibration / PET scan imaging
Californium-252	Oil and gas exploration and manufacturing controls
Selenium-75	Radiography / Quality control
Actinium-225, Yttrium-90, Rhenium 188	Cancer / Infectious disease treatment
Nickel-63	Explosives detection at airports
Gadolinium-160, Neodymium-160	Tracers and contrast agents for biological agents
Iron-57, Barium-135	Standard sources for mass spectroscopy
Sulfur-34	Environmental monitoring
Rubidium-87	Atomic frequency / GPS applications
Lithium-6, Helium-3	Detection of Special Nuclear Materials
Samarium-154	Solar energy / transportation applications



High Energy Physics

Understanding how the universe works at its most fundamental level

The Scientific Challenges:

- Determine the origins of mass in terms of the fundamental particles and their properties
- Exploit the unique properties of neutrinos to discover new ways to explain the diversity of particles
- Discover new principles of nature, such as new symmetries, new physical laws, or unseen extra dimensions of space-time
- Explore the “dark” sector that is 95% of the Universe (Dark Matter and Dark Energy)
- Invent better and cheaper accelerator and detector technologies to extend the frontiers of science and benefit society

FY 2013 Highlights:

- Energy Frontier: Continued support for U.S. researchers at the LHC. The number of researchers is constant with FY 2012
- Intensity Frontier: Research, design, and construction for NOvA, LBNE neutrino experiments, and Mu2e muon experiments. The Reactor Neutrino Experiment in China begins operations in FY 2012
- Cosmic Frontier: U.S. participation in international collaborations pursuing dark matter, dark energy. The Dark Energy Survey in Chile begins operations in FY 2012
- Research in accelerator technologies including superconducting radio frequency and plasma wakefield acceleration

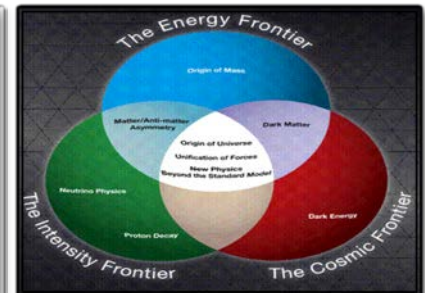
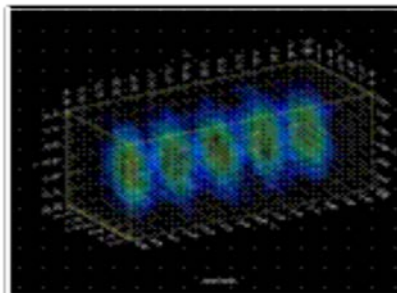
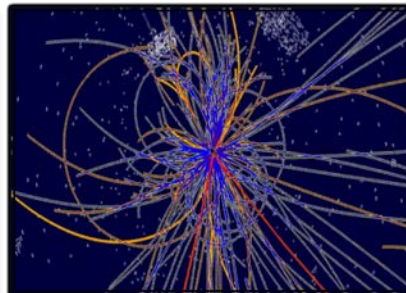

The Dark Energy Program – 2011 Nobel Prize in Physics

Saul Perlmutter, Professor of Physics at the University of California, Berkeley, and senior scientist at Lawrence Berkeley National Laboratory (LBNL), was awarded the 2011 Nobel Prize in Physics. He led the Supernova Cosmology Project that, in 1998, discovered that galaxies are receding from one another faster now than they were billions of years ago.

He shared the prize with Adam G. Riess (Johns Hopkins University) and Brian Schmidt (Australian National University's Mount Stromlo and Siding Spring Observatories).



Saul Perlmutter , Physics Nobel Laureate, 2011, for the discovery of the accelerating expansion of the Universe through observations of distant supernovae.

Tevatron: W Boson Mass

- New results by CDF and DZero: W boson mass now known to 0.02%
- Factor of 2-3 improvements compared with the previous Tevatron measurements

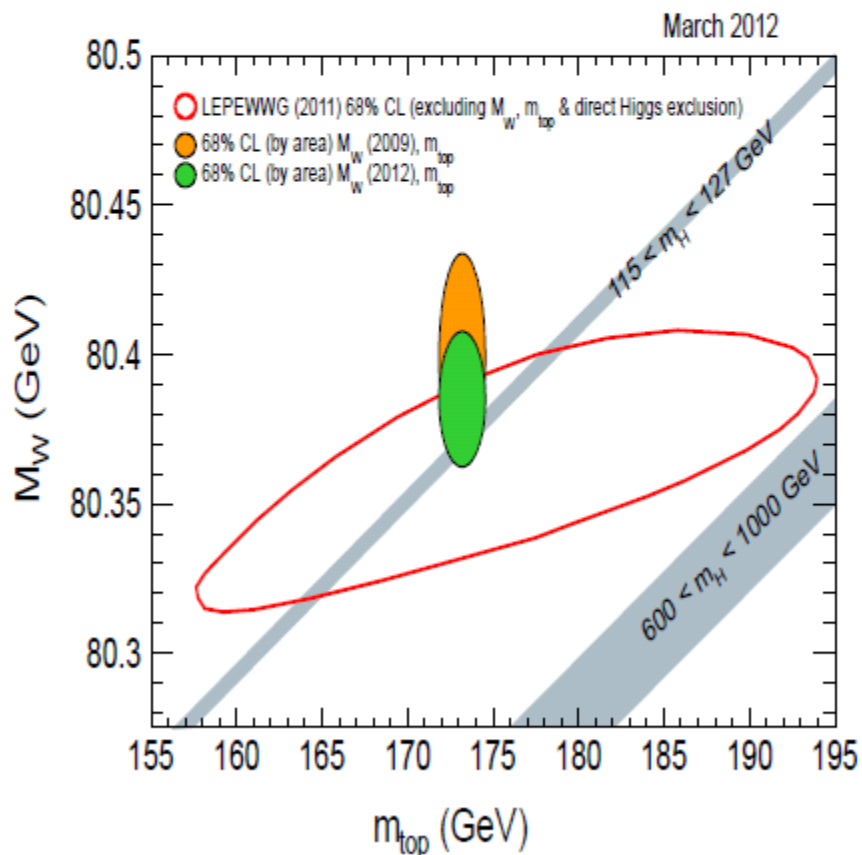
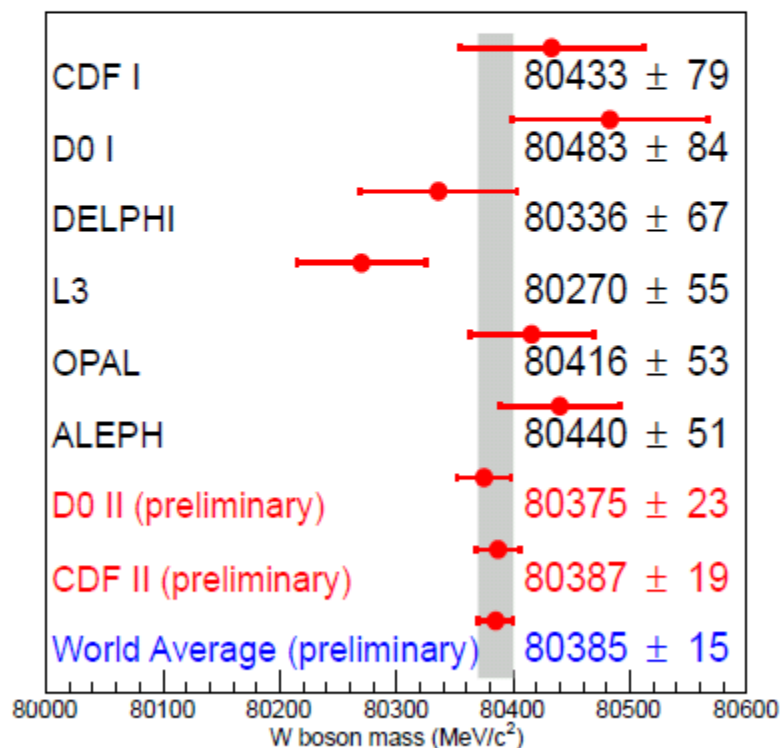

Tevatron: Higgs Boson

- The data appear to be incompatible with the background.

- All channels combined
 - global p-value: 2.2σ
 - local p-value: 2.7σ

- $H \rightarrow bb$ only
 - global p-value: 2.6σ
 - local p-value: 2.8σ

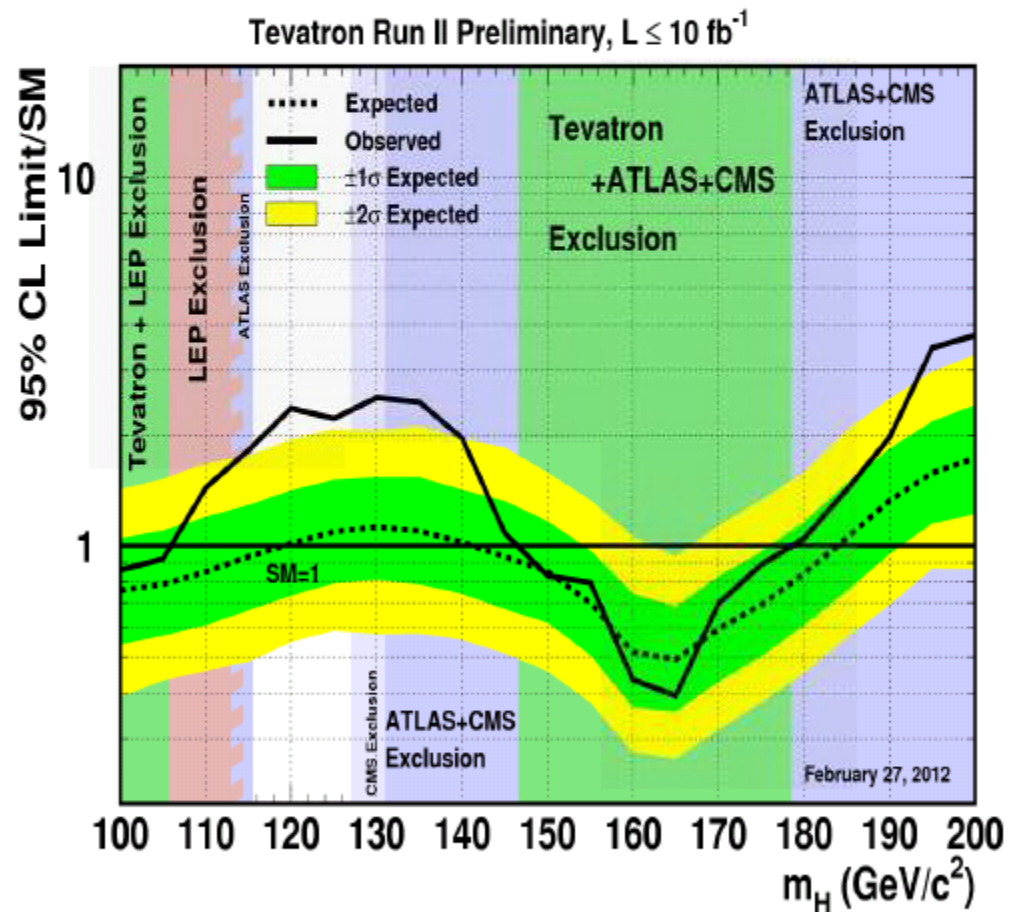

- Further analysis improvements to come in the near future

Neutrinos: θ_{13} at Daya Bay

- Discovery of reactor electron antineutrino disappearance at ~ 2 km \rightarrow Neutrino mixing angle θ_{13} is non-zero at 5.2σ

$$\sin^2 2\theta_{13} = 0.092 \pm 0.016(\text{stat}) \pm 0.005(\text{syst})$$

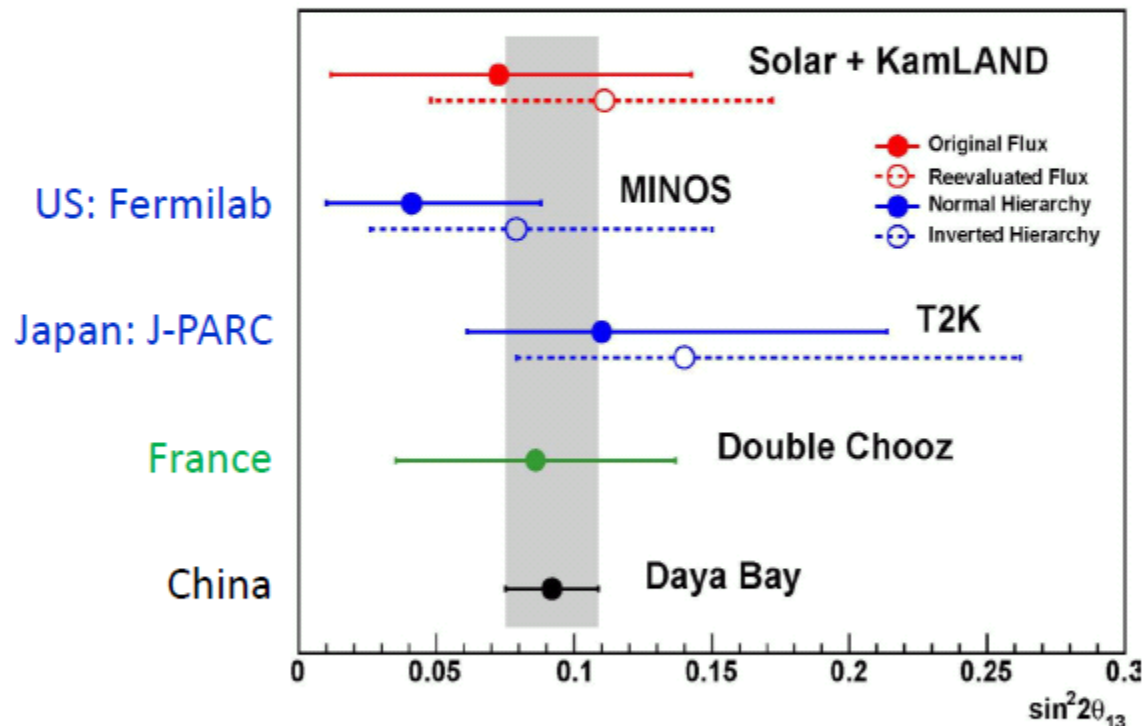

- This value of θ_{13} will enable NOvA at Fermilab to discover the neutrino mass hierarchy and enables a clear path forward towards measuring leptonic CP violation by LBNE.

The Homestake Mine

- The FY 2012 Request includes \$10M to maintain the viability of the Homestake Mine, including dewatering and maintaining security.
- The Liquid Underground Xenon (LUX) dark-matter experiment will begin operations in March 2012 in a cavern supplied by South Dakota and will run through 2013.

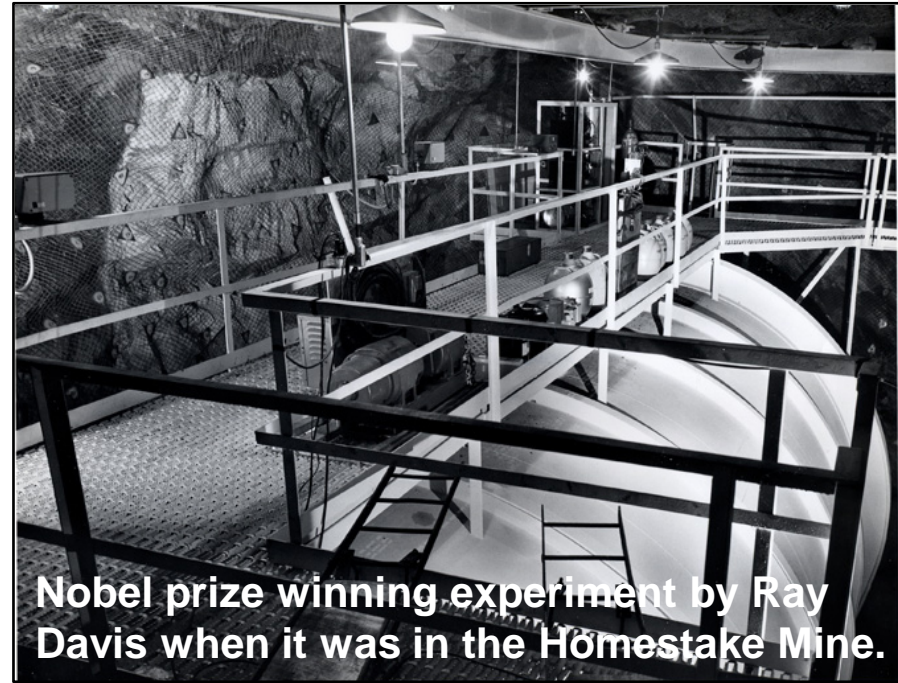

Nobel prize winning experiment by Ray Davis when it was in the Homestake Mine.



Water tank that will hold LUX experiment now in the Davis Cavern

- Operations of the Homestake Mine for science will hinge on the decision on whether to go forward with the Long Baseline Neutrino Experiment, which is expected in March. DOE has received a recommendation on what technology to employ for the detector.

Floor support above water tank





U.S. DEPARTMENT OF
ENERGY

Office of
Science

The End

Workforce Development for Teachers and Scientists

Encouraging and supporting the next generation of scientific talent

Program Goals:

- Increase the pipeline of talent pursuing research important to the Office of Science
- Leverage the resources of the DOE national laboratories for education and training
- Increase participation of under-represented students and faculty in STEM programs
- Improve methods of evaluation of effectiveness of programs and impact on STEM workforce

FY 2013 Highlights:

- Research Experiences at DOE Labs—
 - Science Undergraduate Laboratory Internship
 - Community College Internships
 - Visiting Faculty Program
- National Science Bowl (NSB)—Regional and national middle school and high school competitions to encourage education and careers in science, with 22,000 students from 1,500 schools
- Einstein Distinguished Educator Program—DOE hosts 6 elementary and secondary school mathematics and science teachers at DOE HQ or in Congressional Offices.

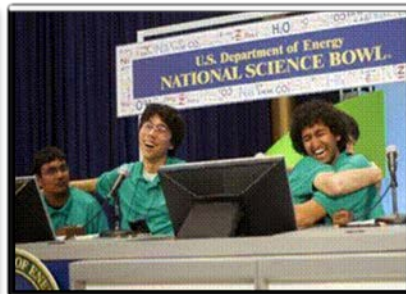

Science Laboratory Infrastructure

Supporting infrastructure and fostering safe and environmentally responsible operations at the Office of Science laboratories

Program Goals:

- Support scientific and technological innovation at the Office of Science (SC) laboratories by providing state-of-the-art research space in modern, safe, and sustainable laboratory facilities.
- Correct longstanding infrastructure deficiencies while ensuring laboratory infrastructure provides a safe and quality work environment.
- Support stewardship responsibilities for the Oak Ridge Reservation and the Federal facilities in the city of Oak Ridge, and provide payments in lieu of taxes to local communities around the Argonne, Brookhaven, and Oak Ridge National Laboratories.

FY 2013 Highlights:

- Funding is initiated for facilities and infrastructure at the OSTI facility in Oak Ridge and the NBL facility at ANL, which was previously budgeted through the SCPD budget.
- Final funding in FY 2012 for Interdisciplinary Science Building – I (BNL) (CD-4 in FY 2013), Technology and Engineering Development Facility (TJNAF) (CD-4 in FY 2014), and Seismic Ph 2 (LBNL) (CD-4 in FY 2015).
- Continuation of four line-item construction projects at ANL, BNL, and SLAC.
- 2 construction starts at FNAL and TJNAF to upgrade, expand, and extend the useful life of utilities systems

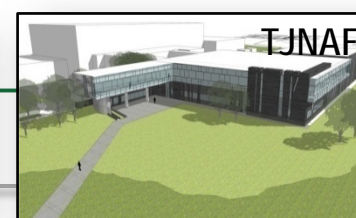

Safeguards and Security

Supporting appropriate levels of protection against unauthorized access, theft, or destruction of DOE assets and hostile acts

Program Goals:

- Provide physical and cyber security controls at SC national laboratory facilities to mitigate risks to facilities and laboratory employees to an acceptable level while enabling the mission.
- Assure site security programs result in secure workplaces that facilitate open and collaborative scientific advances.
- Align accountability for performance through National Standards, rigorous peer review, and Federal oversight through mature contractor assurance systems.
- Protect special, source, and other nuclear materials, radioactive material, and classified and unclassified controlled information at SC laboratories.

FY 2013 Highlights:

- Support for the baseline level of protection to provide mission tailored security.
- Complete security risk assessments at all SC sites to determined required security protection levels.
- Full recovery for Safeguards and Security services to non-DOE customers to reduce pressure on overhead burdens and Safeguard and Security budgets.
- Oversight through mature contractor assurance systems to minimize duplicative audits and assessments.
- Investments in infrastructure and automation technology to reduce reliance on personnel for routine security functions and long-term costs.



Program Direction

Supporting a skilled workforce to oversee Office of Science investments in world-leading scientific research

Program Goals:

- Ensure the recruitment and retention of a highly skilled workforce to provide the planning, execution, oversight, and management of the Office of Science's research programs and world-leading facilities
- Provide an effective modernized business infrastructure to support the scientific mission
- Provide public access to DOE-supported research results
- Support professional development opportunities for the Office of Science workforce
- Working to improve efficiency and transparency of operations

FY 2013 Highlights:

- Supports salaries and benefits of 1,048 FTEs across the Office of Science complex.
- Supports the development of an improved internal grants management system through best-in-class software development.
- Supports development of an integrated, transparent information technology system between HQ and Field operations looking to cloud computing and other cost efficiency gains.

Backup

