

2009 Photosynthetic Systems Research Meeting



**Westin Annapolis Hotel
Annapolis, MD
October 25-28, 2009**



U.S. DEPARTMENT OF
ENERGY

Office of
Science

Office of Basic Energy Sciences
Chemical Sciences, Geosciences &
Biosciences Division

2009 Photosynthetic Systems Research Meeting

DOE Contractors Meeting Program and Abstracts

Westin Annapolis Hotel
Annapolis, MD
October 25-28, 2009

Chemical Sciences, Geosciences, and Biosciences Division
Office of Basic Energy Sciences
Office of Science
U.S. Department of Energy

Cover art is taken from the public domain and can be found at <http://www.publicdomainpictures.net/view-image.php?picture=green-leaves&image=1341>.

This document was produced under contract number DE-AC05-06OR23100 between the U.S. Department of Energy and Oak Ridge Associated Universities.

The research grants and contracts described in this document are supported by the U.S. DOE Office of Science, Office of Basic Energy Sciences, Chemical Sciences, Geosciences and Biosciences Division.

Foreword

This volume summarizes the inaugural Photosynthetic Systems Research Meeting, sponsored by the Chemical Sciences, Geosciences, and Biosciences Division of the Office of Basic Energy Sciences (BES) in the U.S. Department of Energy (DOE). DOE BES Biosciences consists of two programs, Photosynthetic Systems and Physical Biosciences. The Photosynthetic Systems Research Meeting will be held biennially on alternate years from the Physical Biosciences Research Meeting.

This meeting brings together researchers in natural photosynthesis and related biological processes whose work is supported by the core Biosciences programs. During this past fiscal year (2009), additional BES funding for photosynthesis and related research was provided through the Energy Frontier Research Centers and Single Investigator and Small Group Research awards. Recipients of some of these awards are also participating in this year's Photosynthetic Systems Research Meeting. Our goals in holding this meeting are to foster exchange of information, facilitate cooperation and collaboration among research groups, and promote sharing of new ideas, concepts, and techniques. Accordingly, "down time" is scheduled to facilitate informal discussions and interactions among researchers.

The agenda features two invited speakers. We are honored to have Dr. Ken Sauer present the Keynote Talk on the past, present, and future of photosynthesis research and Dr. James McCusker present the Plenary Talk on fundamental issues and application of first-row transition metal-based chromophores for solar cells. In addition, there will be oral presentations and posters presented by funded Principal Investigators in the program. Taken in their entirety, the submitted abstracts for the meeting illustrate the breadth and depth of the high quality, innovative research funded by the program in this critical area of energy science.

We thank all of you for your participation in this meeting and for your dedication in advancing DOE basic research. Your productivity and commitment make a meeting like this not only possible but also gratifying and enjoyable. It is our intent that this meeting will further enhance the innovation, creativity, and success of your research efforts and build a robust community of researchers in this scientific area.

We express appreciation to our distinguished invited speakers, Drs. Sauer and McCusker, for participating in this inaugural meeting. We also thank Diane Marceau of the Chemical Sciences, Geosciences, and Biosciences Division and Margaret Lyday and Connie Lansdon of the Oak Ridge Institute for Science and Education for indispensable assistance and coordination of the meeting logistics. Finally, we thank Larry Rahn for his expert help in assembling this volume.

B. Gail McLean
Robert Stack
Richard V. Greene
Chemical Sciences, Geosciences, and Biosciences Division
Office of Basic Energy Sciences
Department of Energy

Agenda

Agenda
2009 Photosynthetic Systems Research Meeting
Westin Annapolis Hotel, Annapolis, MD
October 25-28, 2009

Sunday, October 25

3:00-6:00 pm **** Registration ****
5:00 pm **** Reception (No Host) ****
6:30 pm **** Dinner ****
7:30 pm *Welcome and Introduction*
Eric Rohlfig, DOE Basic Energy Sciences

Monday, October 26

7:00 am **** Breakfast ****

Keynote Session *Chair: Gail McLean, DOE Basic Energy Sciences*

8:00 am *Welcome and Keynote Speaker Introduction*
Gail McLean, DOE Basic Energy Sciences

8:30 am Oxygenic Photosynthesis: Past, Present and Future
Ken Sauer, Lawrence Berkeley National Laboratory

9:30 am **** Break ****

Session I *Chair: Bob Blankenship, Washington University in St. Louis*

10:00 am Light Energy Transduction in Green Bacteria
Don Bryant, The Pennsylvania State University

10:30 am Folding and Function of Proteorhodopsins in Photoenergy Transducing
Membranes
John Spudich, University of Texas Medical School

11:00 am Secondary Electron-Transfer Reactions of Photosystem II
Gary Brudvig, Yale University

11:30 am Elucidating the Principles that Control Proton-Coupled Electron Transfer Reactions in
the Photosynthetic Protein, Photosystem II
K.V. Lakshmi, Rensselaer Polytechnic Institute

12:00 noon **** Lunch ****

- Session II** *Chair: Sally Mackenzie, University of Nebraska*
- 1:00 pm Genome-wide Identification of Hormone-regulated Transcriptional Targets
Mediating Growth and Defense Response Pathways in Arabidopsis
Joe Ecker, The Salk Institute for Biological Studies
- 1:30 pm Regulation of Plant Cells, Cell Walls, and Development by Mechanical Signals
Elliot Meyerowitz, California Institute of Technology
- 2:00 pm Molecular and Physiological Functions of Plant Glutamate Receptors
Edgar Spalding, University of Wisconsin
- 2:30 pm Molecular Genetic Analysis of Activation-Tagged Transcription Factors
Involved in Photomorphogenesis
Michael Neff, Washington State University
- 3:00 pm **** Free/Discussion Time ****
- 6:00 pm **** Reception (No Host) ****
- 6:30 pm **** Dinner ****
- Poster Session I**
- 7:30 pm **** Even Numbered Posters ****
- 9:30 pm **** Adjourn ****

Tuesday, October 27

- 7:00 am **** Breakfast ****
- Plenary Session** *Chair: Gail McLean, DOE Basic Energy Sciences*
- 8:00 am First-row Transition Metal-based Chromophores for Dye-Sensitized Solar Cells:
Fundamental Issues and Applications
James McCusker, Michigan State University
- 9:00 am **** Break ****
- Session III** *Chair: Terry Bricker, Louisiana State University*
- 9:30 am Advances in Two-Dimensional Electronic Spectroscopy: Applications to Model
Systems and the Reaction Center of Photosystem II
Jennifer Ogilvie, University of Michigan
- 10:00 am The Water-Splitting Apparatus of Photosystem II
Michael Seibert, National Renewable Energy Laboratory
- 10:30 am Regulation of Photosynthetic Light Harvesting
Krishna Niyogi, Lawrence Berkeley National Laboratory
- 11:00 am **** Break ****
- Session IV** *Chair: Tom Okita, Washington State University*
- 11:30 am Retrograde Signaling in Arabidopsis
Joanne Chory, The Salk Institute for Biological Studies
- 12:00 noon Regulation of Thylakoid Membrane Lipid Biosynthesis in Response to the Environment
Christoph Benning, Michigan State University

12:30 pm ***** Lunch *****
1:30 pm ***** Free/Discussion Time *****
***** Dinner on Your Own*****

Poster Session II

7:30 pm ***** Odd Numbered Posters *****
9:30 pm ***** Adjourn *****

Wednesday, October 28

7:00 am ***** Breakfast *****

Session V *Chair: Dave Kramer, Washington State University*

8:00 am Comparative Studies of Homodimeric and Heterodimeric Type I Reaction Centers

John Golbeck, The Pennsylvania State University

8:30 am A Combined Genetic, Biochemical, and Biophysical Analysis of the A₁ Phylloquinone Binding Site of Photosystem I from a Green Alga

Kevin Redding, Arizona State University

9:00 am Biophysical and Biochemical Studies on the Cytochrome b₆ Ubiquinol Oxidase from *Escherichia coli* and Related Systems

Robert Gennis, University of Illinois at Urbana-Champaign

9:30 am ***** Break *****

Session VI *Chair: John Peters, Montana State University*

10:00 am Improving Rubisco Performance in a Warmer World

Michael Salvucci, US Arid-Land Agricultural Research Center

10:30 am Production of Biofuels and Value-Added Products *via* Solar and Chemical Energy Driven Bioconversions of CO₂ Fixing Microbes: Control of CO₂ Assimilation

Robert Tabita, The Ohio State University

11:00 am ***** Break *****

Session VII *Chair: David Stern, Boyce Thompson Institute for Plant Research*

11:30 am Coordination of the Internal and External Chloroplast Division Complexes by ARC6 and PARC6

Katherine Osteryoung, Michigan State University

12:00 noon Regulation of Chloroplast Biogenesis: the *immutans* Variegation Mutant of *Arabidopsis*

Steve Rodermel, Iowa State University

12:30 pm ***** Lunch *****

1:30 pm ***** Open discussion and Program Summary, Poster takedown *****

3:00 pm ***** Adjourn *****

Table of Contents

Table of Contents

Foreword	iii
Agenda	v
Table of Contents	ix
Abstracts	1
Keynote Session	
Ken Sauer - Oxygenic Photosynthesis: Past, Present and Future.....	1
Session I	
Don Bryant - Light Energy Transduction in Green Bacteria.....	3
John Spudich – Folding and Function of Proteorhodopsins in Photoenergy Transducing Membranes.....	5
Gary Brudvig – Secondary Electron-Transfer Reactions of Photosystem II.....	7
K.V. Lakshmi – Elucidating the Principles that Control Proton-Coupled Electron Transfer Reactions in the Photosynthetic Protein, Photosystem II.....	9
Session II	
Joe Ecker - Genome-wide Identification of Hormone-regulated Transcriptional Targets Mediating Growth and Defense Response Pathways in Arabidopsis.....	11
Elliot Meyerowitz – Regulation of Plant Cells, Cell Walls, and Development by Mechanical Signals.....	13
Edgar Spalding – Molecular and Physiological Functions of Plant Glutamate Receptors.....	15
Michael Neff – Molecular Genetic Analysis of Activation-Tagged Transcription Factors Involved in Photomorphogenesis.....	17
Poster #	Poster Session I
2	Lisa M. Utschig, Oleg G. Poluektov, Lin X.Chen and David M. Tiede – Photosynthetic Interprotein Electron Transfer.....
	19
4	Willem F.J. Vermaas – Chlorophyll Synthesis and Stability in Cyanobacteria.....
	21
6	Marilyn Gunner, Doug Bruce and Victor Batista – Studies of Photosynthetic Reaction Centers and Biomimetic Systems.....
	23
8	G. Eric Schaller – Post-Transcriptional Regulation of Ethylene Perception and Signaling in Arabidopsis.....
	25
10	Vittal K. Yachandra, Junko Yano and Kenneth Sauer – Geometric and Electronic Structure of the Mn ₄ Ca Cluster in Photosystem II.....
	27
12	John W. Peters – Novel Mechanisms of Microbial CO ₂ Fixation.....
	29
14	Maria L. Ghirardi – Regulation of H ₂ and CO ₂ Metabolism: Factors Involved in Partitioning of Photosynthetic Reductant in Green Algae.....
	31
16	Robert E. Blankenship – Mechanism of Solar Energy Storage by Chlorosome Antennas of Green Photosynthetic Bacteria.....
	33

18	Robert A. Niederman – Proteomic Analysis of the Developing Intracytoplasmic Membrane During Chromatic Adaptation in <i>Rhodobacter sphaeroides</i>	35
20	Albrecht G. von Arnim – Eukaryotic Initiation Factor 3 (eIF3) and mRNA Leader Sequences as Agents of Translational Regulation in Arabidopsis.....	37
22	Kentaro Inoue – Defining the Significance of Protein Maturation in Thylakoid Development.....	39
24	John Clark Lagarias, John C. Meeks, R. Dave Britt, Delmar Larsen, and Thomas Huser – Photoreceptor Regulation and Optimization of Energy Harvesting in <i>Nostoc punctiforme</i>	41
26	Zhenbiao Yang – ROP9 GTPase Signaling in Auxin Regulation of Plant Growth.....	43
28	Sally Mackenzie – Organellar Protein Targeting and Nuclear Influence on Mitochondrial Behavior.....	45
30	David M. Kramer – The Energy Budget of Steady-State Photosynthesis.....	47
32	Bernd Markus Lange – Unraveling the Regulation of Terpenoid Oil and Oleoresin Biosynthesis for the Development of Biocrude Feedstocks.....	49
34	Himadri B. Pakrasi – Novel Factors in the Thylakoid Lumen that Regulate Photoprotection and Repair of the Photosynthetic Apparatus in Cyanobacteria.....	51

Plenary Session

James McCusker - First-row Transition Metal-based Chromophores for Dye-Sensitized Solar Cells: Fundamental Issues and Applications.....	53
--	----

Session III

Jennifer Ogilvie – Advances in Two-Dimensional Electronic Spectroscopy: Applications to Model Systems and the Reaction Center of Photosystem II.....	55
Michael Seibert – The Water-Splitting Apparatus of Photosystem II.....	57
Krishna Niyogi, Graham R. Fleming – Regulation of Photosynthetic Light Harvesting.....	59

Session IV

Joanne Chory – Retrograde Signaling in Arabidopsis.....	61
Christoph Benning – Regulation of Thylakoid Membrane Lipid Biosynthesis in Response to the Environment.....	63

Poster

Poster Session II

1	David M. Tiede, Lin X. Chen, O. G. Poluektov, Lisa M. Utschig and Gary Wiederrecht – Mapping Structure with Function in Natural and Biomimetic Photosynthesis.....	65
3	Oleg G. Poluektov, Lisa M. Utschig, Lin Chen and David M. Tiede – Regulation of the Electron Transfer in Natural Photosynthesis.....	67
5	David B. Stern – Antisense RNAs in the Chloroplast.....	69
7	Ann McDermott and Paul Harvilla – Characterization of Photosynthetic Proteins by Solid State NMR Spectroscopy.....	71
9	Ryszard Jankowiak – New Insight into the Electronic Structure of the CP47 Antenna Protein Complex of Photosystem II: Hole-Burning Study and Simulation of Optical Spectra.....	73
11	Terry M. Bricker and Laurie K. Frankel – Identification of Protein – Chloride Interactions in Photosystem II.....	75

13	Maria L. Ghirardi, P. W. King, K. Kim, C. Chang, D. Gust, A. L. Moore, T. A. Moore, M. J. Heben – Structural, Functional, and Integration Studies of Solar-Driven, Bio-Hybrid, H ₂ -Producing Systems.....	77
15	Kenneth Keegstra and John E Froehlich – Protein Targeting to the Thylakoid Membrane.....	79
17	Sergei Savikhin – Triplet Excitons: a Novel Photoprotection Mechanism in Strongly Coupled Photosynthetic Complexes.....	81
19	David B. Knaff – Ferredoxin-Dependent Plant Metabolic Pathways.....	83
21	Ralph L. Henry, T.K.S. Kumar and Robyn L. Goforth – cpSRP-based Protein Targeting to Thylakoid Membranes.....	85
23	Steven M. Theg – Energetics of Protein Transport across Chloroplast Membranes.....	87
25	Janos K. Lanyi and Sergei P. Balashov – Interaction of Antenna Carotenoid and Retinal in the Light-driven Proton Pump Xanthorhodopsin.....	89
27	Sergei Dikanov, Antony R. Crofts, Robert B. Gennis and Colin A. Wraight – Resolving Protein-Semiquinone Interactions by Two-Dimensional Pulsed EPR Spectroscopy.....	91
29	Fevzi Daldal – Membrane-attached Electron Carriers in Photosynthesis and Respiration: Structure, Function and Maturation of c-type Cytochromes.....	93
31	Thomas W. Okita, Seon-kap Hwang – Enhancement of Photoassimilate Utilization by Manipulation of ADPglucose Pyrophosphorylase and Phosphorylase.....	95
33	Dewey Holten, Christine Kirmaier, Robert E. Blankenship, Deborah K. Hanson and Philip D. Laible – Controlling Electron Transfer Pathways in Photosynthetic Reaction Centers.....	97
	Robert L Burnap – Integration of the Light and Dark Reactions of Oxygenic Photosynthesis: NADPH/NADP ⁺ Ratio Controls the Expression of the High Affinity Inorganic Carbon Concentrating Mechanism (CCM).....	99

Session V

	John Golbeck – Comparative Studies of Homodimeric and Heterodimeric Type I Reaction Centers.....	101
	Kevin Redding – A Combined Genetic, Biochemical, and Biophysical Analysis of the A ₁ Phylloquinone Binding Site of Photosystem I from a Green Alga.....	103
	Robert Gennis – Biophysical and Biochemical Studies on the Cytochrome b ₆ Ubiquinol Oxidase from <i>Escherichia coli</i> and Related Systems.....	105

Session VI

	Michael Salvucci and Archie R. Portis – Improving Rubisco Performance in a Warmer World.....	107
	Robert Tabita – Production of Biofuels and Value-Added Products <i>via</i> Solar and Chemical Energy Driven Bioconversions of CO ₂ Fixing Microbes: Control of CO ₂ Assimilation.....	109

Session VII

	Katherine Osteryoung – Coordination of the Internal and External Chloroplast Division Complexes by ARC6 and PARC6.....	111
	Steve Rodermel – Regulation of Chloroplast Biogenesis: the <i>immutans</i> Variegation Mutant of Arabidopsis.....	113

Author Index	115
List of Participants	117

Keynote Session

Oxygenic Photosynthesis Past, Present and Future

Ken Sauer
Physical Biosciences Division, LBNL
University of California, Berkeley, CA 94720
Email: KHSauer@LBL.GOV

Oxygenic photosynthesis is a prime example of Darwinian evolution on Earth. Distributed among the kingdoms of cyanobacteria, phytoplankton, algae and higher plants, the ability to use sunlight and substrate water to produce dioxygen and reducing power has transformed Earth's atmosphere and environment. Looking to the future we seek to understand the means by which this ability to use abundant water and sunlight might be engineered to provide alternative sources of fuel and energy for society's needs. Success in this endeavor requires overcoming significant obstacles.

Criteria for success include: (1) achieving a high quantum yield for producing fuel or electricity in full sunlight and using water as substrate; (2) developing a system that is robust against photo-damage and is inexpensive to produce and maintain; (3) discerning and profiting from understanding how the 4-electron transfer from water to produce dioxygen occurs in photosynthesis and how it has succeeded in permeating the bacterial, archaean and eukaryotic world.

Research in photosynthesis during the past century provides significant lessons to help chart the course of promising future research. Recent advances in ultrafast kinetics, biomolecular structure determination and in supporting applications of quantum mechanical theory, proteomics and complete genome sequencing are opening exciting new research directions. I will present examples involving a new approach that interprets structural data along with proteomic information and that has relevance to the evolution of photosynthetic water oxidation in cyanobacteria, marine algae and land plants. This is an example of the use of new tools and information to help us in learning how to harness the sun.

Session I

Light Energy Transduction in Green Bacteria (DE-FG02-94ER20137)

Donald A. Bryant, Principal Investigator

Dept. of Biochemistry and Molecular Biology, The Pennsylvania State University, University Park, PA 16802 USA

E-mail: dab14@psu.edu

Web: <http://www.bmb.psu.edu/faculty/bryant/bryant.html>

Overall research goals: The long-term objectives of this research program are to understand the photosynthetic apparatus of green bacteria, and in particular to understand the structure, function, and biogenesis of their remarkable light-harvesting antennae, chlorosomes. Chlorosomes occur in all phototrophic *Chlorobi* (GSB), some filamentous anoxygenic phototrophs (FAPs) belonging to the phylum *Chloroflexi*, and the newly discovered chlorophototroph, *Candidatus Chloracidobacterium thermophilum*, an aerobic member of the phylum *Acidobacteria*. We have employed genomic, bioinformatic, genetic and biochemical approaches to understand pigment biosynthesis, reaction centers, electron transport chains, and other metabolic properties of green bacteria that are critically important to their ability to transduce light energy efficiently into chemical energy.

Significant achievements 2007-2009: During this period, we established the complete biosynthetic pathways for the synthesis of the carotenoids chlorobactene and isorenieratene as well as for the biosynthesis of bacteriochlorophyll (BChl) *c* and *d*.

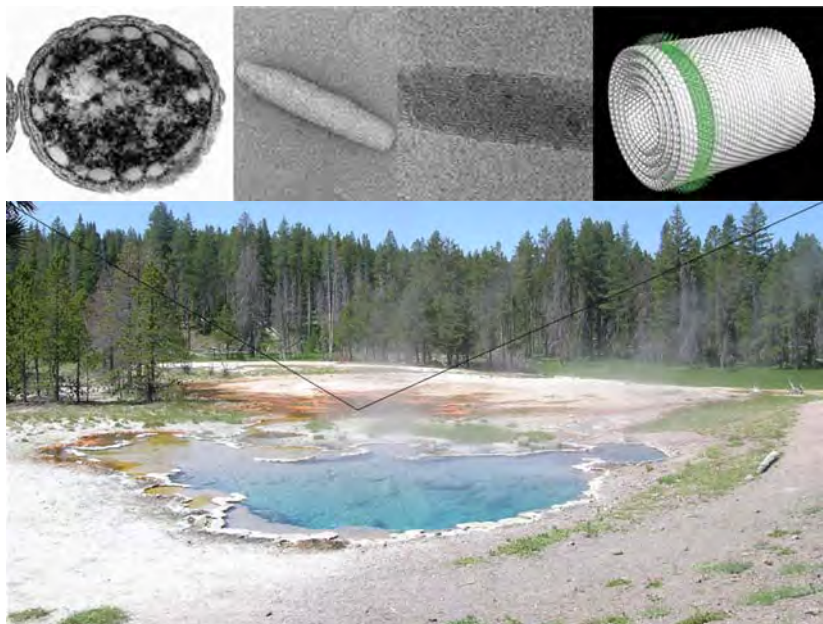

Figure 1. Montage showing Octopus Spring (Yellowstone National Park), from which *Candidatus Chloracidobacterium thermophilum* was isolated and a series of structures showing increasing levels of detail for chlorosomes of the green sulfur bacterium *Chlorobaculum tepidum*. From top left to right: a thin section showing chlorosomes appressed to the cytoplasmic membrane; an isolated chlorosome from the *bchQ bchR bchU* mutant; cryo-EM view of a chlorosome from the *bchQ bchR bchU* mutant; and a model showing the concentric rings of *syn-anti* monomer stacks of BChl *d* that form the shallow helices that in turn form the lamellar surfaces of BChls in chlorosomes.

Chloracidobacterium thermophilum, the first chlorophototrophic member of the phylum *Acidobacteria*, was discovered and characterized. Surprisingly, this new type of photoheterotroph is an aerobe, which has a photosynthetic apparatus that is similar to that of green sulfur bacteria (homodimeric Type 1 reaction centers, FMO protein, chlorosomes). Most notably, a combination of synthetic biology, solid-state NMR, and cryo-electron microscopy methods were employed to solve the structure of BChl *c* and *d* in chlorosomes of *Chlorobaculum tepidum* (see Fig. 1). We have also recently characterized the chlorosomes and FMO protein of *Cab. thermophilum*. Metagenomic

and metatranscriptomic approaches have provided evidence for the occurrence of two previously undescribed chlorophototrophs belong to novel classes of the *Chlorobi* and *Chloroflexi* in alkaline siliceous hot spring mats in Yellowstone National Park.

Science objectives for 2010-2012:

- Develop methods for genetic transformation of BChl *e*-containing green sulfur bacteria and identify the enzymes required for conversion of BChl *c* into BChl *e*
- Isolate and characterize the presumed oxygen-stable, homodimeric reaction centers of *Cab. thermophilum*
- Complete a comparative genomic and proteomic analysis of *Chlorobi* and *Chloroflexi* (collaboration with Drs. Mary Lipton and Stephen Callister, PNNL)

References to some of the research supported by this project 2007-2009:

1. Gomez Maqueo Chew, A., and Bryant, D. A. 2007. Chlorophyll biosynthesis in bacteria: the origins of structural and functional diversity. *Annu. Rev. Microbiol.* **61**: 113-129.
2. Bryant, D. A., Garcia Costas, A. M., Maresca, J. A., Gomez Maqueo Chew, A., Klatt, C. G., Bateson, M. M., Tallon, L. J. Hostetler, J., Nelson, W. C., Heidelberg, J. F., Ward, D. M. 2007. “*Candidatus Chloracidobacterium thermophilum*”: an aerobic phototrophic acidobacterium. *Science* **317**: 523-526.
3. Maresca, J. A., Graham, J. E., Wu, M., Eisen, J. A. and Bryant, D. A. 2007. Identification of a fourth family of lycopene cyclases in photosynthetic bacteria. *Proc. Natl. Acad. Sci. USA* **104**: 11784-11789.
4. Gomez Maqueo Chew, A., Frigaard, N.-U., and Bryant, D. A. 2007. Bacteriochlorophyllide *c* C-8² and C-12¹ methyltransferases are essential for adaptation to low light in *Chlorobaculum tepidum*. *J. Bacteriol.* **189**: 6176-6184.
5. Oostergetel, G. T., Reus, M., Gomez Maqueo Chew, A., Bryant, D. A., Boekema, E. J., and Holzwarth, A. R. 2007. Long-range organization of bacteriochlorophyll in chlorosomes of *Chlorobium tepidum* investigated by cryo-electron microscopy. *FEBS Lett.* **581**: 5435-5439.
6. Maresca, J. A., Graham, J. E., and Bryant, D. A. 2008. Carotenoid biosynthesis in chlorophototrophs: the biochemical and genetic basis for structural diversity. *Photosynth. Res.* **97**: 121-140.
7. Maresca, J. A., Romberger, S. P., and Bryant, D. A. 2008. Isorenieratene biosynthesis in green sulfur bacteria requires the cooperative actions of two carotenoid cyclases. *J. Bacteriol.* **190**: 6384-6391.
8. Ganapathy, S., Oostergetel, G. T., Wawrzyniak, P. K., Reus, M., Gomez Maqueo Chew, A., Buda, F., Boekema, E. J., Bryant, D. A., Holzwarth, A. R., and de Groot, H. J. M. 2009. Alternating *syn-anti* bacteriochlorophylls form concentric helical nanotubes in chlorosomes. *Proc. Natl. Acad. Sci. USA* **106**: 8525-8530.
9. Gomez Maqueo Chew, A., Frigaard, N.-U., and Bryant, D. A. 2009. Mutational analysis of three *bchH* paralogs in (bacterio)-chlorophyll biosynthesis in *Chlorobaculum tepidum*. *Photosynth. Res.* **101**: 21-34.
10. Li, H. and Bryant, D. A. 2009. Envelope proteins of the CsmB/CsmF and CsmC/CsmD motif families help determine the size, shape and composition of chlorosomes in *Chlorobaculum tepidum*. *J. Bacteriol.*, minor revisions.

Folding and Function of Proteorhodopsins in Photoenergy Transducing Membranes

John L. Spudich, Principal Investigator

Oleg A. Sineshchekov, Research Associate Professor; Maria Ntefidou, Post-doctoral Fellow

Center for Membrane Biology, University of Texas Medical School, Houston, TX 77030;
John.L.Spudich@uth.tmc.edu; <http://www-bmb.med.uth.tmc.edu/faculty/john-spudich.html>

Overall research goals: The overall research objectives are to develop proteorhodopsin (PR) proteins as a model system for α -helical membrane protein insertion and folding, and to advance understanding of the diversity and mechanisms of PRs, a large family of photoenergy transducers (>4000 identified) abundant in the world's oceans. Specific aims are: (1) To develop a high-efficiency genetic selection procedure for light-driven proton-pumping in *E. coli* cells. Such a procedure will provide a positive selection method for proper folding and function of PRs in the *E. coli* membrane. (2) Characterize flash-induced absorption changes and photocurrents in PR variants in organisms from various environments, and their expression level and function when expressed in *E. coli*. Subaims are to: (a) elucidate the relationship of the transport mechanism to mechanisms of other microbial rhodopsins, some of which like PRs function as ion transporters and some of which use light energy to activate signaling pathways (sensory rhodopsins); and (b) identify important residues and chemical events in light-driven proton transport by PRs. In addition to their importance to the energy of the biosphere PRs have attracted interest for their potential for use in making photoenergy-transducing membranes for bioengineering applications.

Significant achievements 2007-2009:

1. We characterized photochemical reaction cycles and photocurrents in 20 PR variants from organisms from various environments. The PRs differ greatly in expression level of functional pigments which correlates neither with photocycle rate, nor with absorption maximum. Proteorhodopsin from the Antarctic bacterial species *Psychroflexus torquis* exhibits two unusual properties: (i) A very fast photocycle with halftime at 20°C of 2.6 ms, ~3-fold faster than the most rapid previously measured proton-pumping rhodopsin. We attribute this fast rate to its adaptation to sea-ice temperature. (ii) Flash-induced absorption difference spectra reveal fine structure, which may be from polyene stretching vibrational modes as in sensory rhodopsin II, or may possibly be a first indication of Förster resonance energy transfer from a bound carotenoid in this carotenoid-rich bacterium, a process which has been proven to occur in the proton pump xanthorhodopsin. Therefore *Psychroflexus* PR may be the fastest retinylidene proton pump and also may have an enhanced absorption range and efficiency of energy capture, properties potentially useful for bioengineering applications.
2. New key residues in PRs were identified and their roles in the transport mechanism assessed (publications 1-5). We identified two new residues (His75 and Glu142) participating in proton transfers. A deprotonation/reprotonation subcycle of His75 within the pumping cycle is a novel mechanism in rhodopsins and appears to be ubiquitous in PRs (1).
3. We identified a shared fundamental process, the Schiff base “connectivity switch”, in the mechanisms of proton transport and signaling by the rhodopsin family (8) and clarified the relationship between energy and sensory transduction by microbial rhodopsins (6-8).
4. Our extensive characterization of *E. coli* physiological responses to light-driven proton pumping in this project argued for a selection protocol based on designing conditions in which light-driven proton ejection protects against an abrupt short-term stress in non-growing conditions, i.e. a “shock”. We now have optimized and finalized development of a highly efficient genetic selection procedure for light-driven proton-pumping in *E. coli* cells based on low pH shock. We developed the method using co-expression of two microbial rhodopsins that have opposite effects on cell survival during a low pH shock: the chloride pump halorhodopsin

(HR) and a proton pump rhodopsin HTDR. Shock conditions are 45-min incubation at pH4 in the presence of azide and a low concentration of CCCP, and intense illumination with broad-band yellow light. The rationale is that HR, which hyperpolarizes the membrane by inwardly directed electrogenic chloride transport, facilitates acidification of the cytoplasm eliminating cells without functional PRs, which rescue the cells by pumping protons out. We assessed the selection efficiency (i.e. extent of enrichment) of this procedure by adding cells expressing both HR and HTDR to cell suspensions containing cells expressing only HR in various proportions. The most dramatic result was that when the HTDR-expressing cells were introduced in a ratio of 1:10⁶, after selection 100% of the viable population consists of HTDR-expressing cells, i.e. an enrichment factor of $\geq 10^6$ -fold in a single pass of the selection, excellent for our purposes (M. Ntefidou, O.A. Sineshchekov, and J.L. Spudich, in preparation).

Science objectives for 2009-2010:

- Over the remainder of the grant period the main effort will be to implement the low pH shock method to select for functional folding of proton pump variants that we identified during the course of the grant that do not fold functionally into the *E. coli* membrane, as well as for reduction in the Schiff base proton acceptor pK_a in the well studied GPR, which expresses well in *E. coli* but exhibits a pK_a of 7.2 for proton ejection and therefore cannot protect the cells from the pH4 shock. The immediate next step toward this end is to implement protocols capable of generating randomly mutated libraries of the non-functional variants containing at least 10⁷ different mutant cells and minimal levels of mutation redundancy.
- We will continue to analyze structure/function of proteorhodopsins, including spectroscopic and electrical measurements of proteorhodopsin mutants, vibrational spectroscopy (in collaboration with K.J. Rothschild, Boston University), to further elucidate chemical events in the proton translocation process. In particular we will further characterize Psychroflexus proteorhodopsin because of its unusual properties and its promise as a biotechnological tool.

References to work supported by this project 2007-2009:

Research articles on proteorhodopsin mechanism:

1. Bergo VB, Sineshchekov OA, Kralj JM, Partha R, Spudich EN, Rothschild KJ, and Spudich JL (2009) His75 in proteorhodopsin, a novel component in light-driven proton translocation by primary pumps. *J. Biol. Chem.* 284:2836-2843.
2. Amsden JJ, Kralj JM, Bergo VB, Spudich EN, Spudich JL, and Rothschild, KJ (2008) Different structural changes occur in blue- and green-proteorhodopsins during the primary photoreaction. *Biochemistry* 47:11490-11498.
3. Kralj JM, Spudich EN, Spudich JL, Rothschild KJ (2008) Raman spectroscopy reveals direct chromophore interactions in the Leu/Gln105 spectral tuning switch of proteorhodopsins. *J. Phys. Chem. B.* 112:11770-11776.
4. Kralj JM, Bergo VB, Amsden JJ, Spudich EN, Spudich JL, Rothschild KJ (2008) Protonation State of Glu142 Differs in the Green- and Blue-Absorbing Variants of Proteorhodopsin. *Biochemistry* 47:3447-3453.
5. Amsden JJ, Kralj JM, Chieffo LR, Wang X, Dreamily S, Spudich EN, Spudich JL, Ziegler LD, Rothschild KJ (2007) Subpicosecond protein backbone changes detected during the green-absorbing proteorhodopsin primary photoreaction. *J. Phys. Chem. B.* 111:11824-11831.

Research articles on the relationship of the mechanism of proteorhodopsin and homologous light-driven proton pumps to the mechanism of signal transduction by light-sensing rhodopsins:

6. Sineshchekov OA, Govorunova EG, and Spudich JL (2009) Photosensory functions of channelrhodopsins in native algal cells. *Photochem. Photobiol.* 85:556-563.
7. Bergo, VB, Spudich, EN, Spudich, JL, and Rothschild KJ (2009) Active water in protein-protein communication within the membrane: the case of SRII-HtrII signal relay, *Biochemistry* 48:811-813.
8. Sineshchekov OA, Sasaki J, Phillips BJ, and Spudich JL (2008) A Schiff base connectivity switch in sensory rhodopsin signaling. *Proc. Natl. Acad. Sci. USA* 105:16159-16164.

Secondary Electron-Transfer Reactions of Photosystem II

Gary W. Brudvig, Principal Investigator

Yunlong Gao, Postdoctoral Research Associate

Katherine Shinopoulos, Graduate Student

Department of Chemistry, Yale University, P.O. Box 208107, New Haven, CT 06520-8107

Email: gary.brudvig@yale.edu; Web: <http://ursula.chem.yale.edu/~brudvig/>

Overall research goals: Photosystem II (PSII) is the only natural photosynthetic reaction center that generates an oxidant sufficiently strong to oxidize its own light-harvesting pigments. As a result of this propensity for oxidative damage, PSII is distinct from other photosynthetic complexes in having secondary electron donors that include carotenoid (Car) and chlorophyll (Chl) molecules (Figure 1). Thus, carotenoids in PSII have unique redox functions in addition to their roles also found in other photosynthetic complexes as light-harvesting pigments, as photoprotective molecules in triplet energy-transfer processes, as singlet O₂ scavengers and as components that stabilize pigment-protein structures. This makes PSII an ideal system in which to determine the factors that control carotenoid function in natural photosynthetic systems. The long-term objective of this project is to determine the primary factors that influence carotenoid function in PSII. The specific aims of the current project are: (1) to characterize the redox-active Car and Chl molecules that function in the secondary electron-transfer reactions of PSII and to determine the sequence of electron-transfer events (photooxidation and charge-recombination reactions) in the secondary electron-transfer pathways by (a) study of site-directed mutants of PSII in which amino-acid residues predicted to perturb cofactors in the secondary electron-transfer pathways are changed, (b) characterization of the formation of Car neutral radicals in PSII, (c) modeling the kinetics of hole hopping and the distribution of oxidized Car and Chl molecules in the secondary electron-transfer pathways of PSII by using structure-based Marcus-theory calculations, and (d) determining the kinetics and energetics of the secondary electron-transfer reactions by using Stark spectroscopy; (2) to characterize the photoprotective functions of the secondary electron-transfer reactions in PSII by

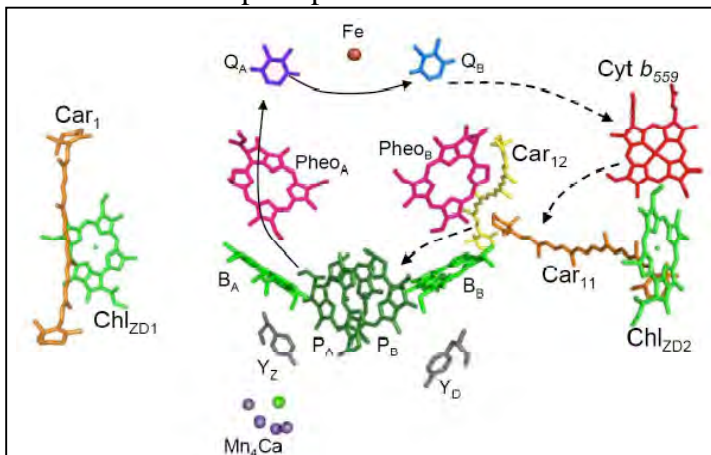

Figure 1. Redox cofactors in the PSII complex (PDB code 3BZ1) showing primary (solid lines) and secondary (dashed lines) electron-transfer reactions.

determining the redox chemistry of Cars in O₂-evolving green plant PSII for comparison with results for O₂-evolving cyanobacterial PSII obtained previously; (3) to develop a system for systematic structure/function studies of Cars in PSII and to determine the role of Cars in PSII assembly and secondary electron transfer by (a) developing methods to deliver non-native Cars to a Car-deficient strain of *Synechocystis* PCC 6803 for assembly of PSII with non-native Cars, and (b) determining the structural and redox requirements of Cars in the assembly and secondary electron-transfer reactions of PSII by studying PSII with non-native Cars.

Significant achievements 2007-2009:

- We characterized the formation and decay of near-IR absorption bands in light-minus-dark difference spectra of O₂-evolving *Synechocystis* PSII core complexes illuminated at cryogenic temperatures (Figure 2). In contrast to previous results for Mn-depleted PSII, multiple near-IR absorption bands are resolved in the light-minus-dark difference spectra of O₂-evolving *Synechocystis* PSII core complexes.

- We identified a novel absorption peak at 750 nm that is induced by illumination of PSII core complexes at low temperature (Figure 2). The absorption peak at 750 nm does not fit with either a Chl cation radical or a Car cation radical, but matches closely with the most stable Car neutral radical in which a proton is lost from the 4(4') position of the β -carotene radical cation (Figure 3).

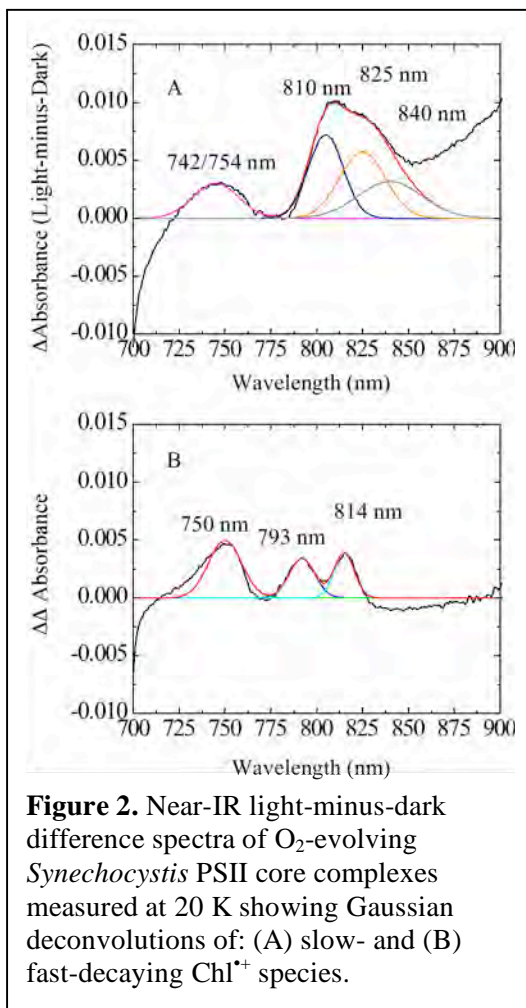

Science objectives for 2009-2010:

- By using the modeling program Coot, the mutations D2-G47F, D2-G47W and D2-T50F have been identified as causing possible disruptions to the hydrophobic binding pocket of Car₁₁ (Figure 1). Peter Nixon has recently generated D2 mutants (at residues Gly47 and Thr50) in a His-tagged CP47 background, and we are currently working to grow the cells and characterize PSII from these strains.
- In collaboration with Doug Bruce and Serguei Vassiliev, we are working to simulate the dynamics of hole hopping and charge recombination involving the Chl and Car radicals in PSII by using Marcus theory, together with the locations of the cofactors in the recent X-ray structure of PSII, in order to analyze pathways of secondary electron transfer and locations of the Chl and Car radicals.
- DFT calculations predict that Car neutral radicals formed by deprotonation at the 5(5'), 9(9') and 13(13') positions have absorption maxima in the visible region, although not yet detected because of interference in the visible range by the absorption from neutral Chl and Car. We will investigate the formation of these Car neutral radicals in PSII.

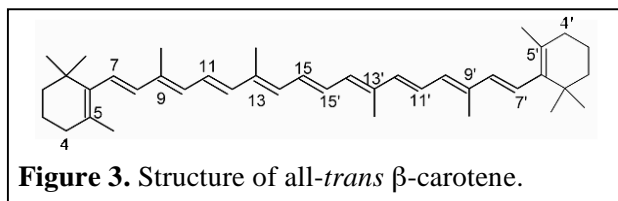

References to work supported by this project 2007-2009:

1. "Characterization of the Secondary Electron-Transfer Pathway Intermediates of Photosystem II Containing Low-Potential Cytochrome b₅₅₉", Cara A. Tracewell and Gary W. Brudvig (2008) *Photosynth. Res.* 98, 189-197.
2. "Multiple Redox-Active Chlorophylls in the Secondary Electron-Transfer Pathways of Oxygen-Evolving Photosystem II", Cara A. Tracewell and Gary W. Brudvig (2008) *Biochemistry* 47, 11559–11572.
3. "Redox Reactions of the Non-Heme Iron of Photosystem II: An EPR Spectroscopic Study", James P. McEvoy and Gary W. Brudvig (2008) *Biochemistry* 47, 13394-13403.
4. "Redox Reactions of the Non-Heme Iron of Photosystem II: An EPR Spectroscopic Study", James P. McEvoy and Gary W. Brudvig (2008) in: "Photosynthesis. Energy from the Sun: 14th International Congress on Photosynthesis", (J. F. Allen, E. Gantt, J. H. Golbeck and B. Osmond, eds.) Springer Publishers, New York, pp. 141-144.
5. "Formation of Carotenoid Neutral Radicals in Photosystem II", Yunlong Gao, Katherine E. Shinopoulos, Cara A. Tracewell, A. Ligia Focsan, Gary W. Brudvig and Lowell D. Kispert (2009) *J. Phys. Chem. B* 113, 9901–9908.

Elucidating the Principles that Control Proton-Coupled Electron Transfer Reactions in the Photosynthetic Protein, Photosystem II.

K. V. Lakshmi,¹ Principal Investigator

O. G. Poluektov² and D. Tiede,² Senior Collaborators; S. Milikisiyants,¹ Postdoctoral Associate

¹Department of Chemistry and Chemical Biology and the Baruch '60 Center for Biochemical Solar Energy Research, Rensselaer Polytechnic Institute, Troy, NY 12180

²Chemical Sciences and Engineering Division, Argonne National Laboratory, Argonne, IL 60439

Email: Lakshk@rpi.edu

Overall Research Goals: The solar water-splitting protein complex, photosystem II (PSII), catalyzes one of the most energetically demanding reactions in Nature by using light energy to drive a catalyst capable of oxidizing water. Proton-coupled electron transfer (PCET) reactions, which are exquisitely tuned by smart protein matrix effects, are central to the water-splitting chemistry of PSII. Elucidating the water-splitting chemistry of PSII is of major importance in designing bio-inspired catalytic systems for solar fuels production. Proton motion coupled to electron transfer is the basic mechanism of biological energy conversion. However, the details of PCET processes are not yet understood because of the inability of conventional methods to directly probe PCET processes. A major challenge is to develop methods to directly probe PCET processes to understand the structural requirements for minimizing the energetic penalty for multiple charge transfers. The objective of our research is to elucidate the tuning and regulation of PCET reactions of PSII and to determine their role in the early charge-transfer steps of photosynthesis. We are studying the factors that control the coupling of proton and electron transfer pathways at the catalytic tetranuclear manganese-calcium-oxo ($\text{Mn}_4\text{Ca-oxo}$) cluster, the redox-active tyrosine and quinone cofactors of PSII by the development of new state-of-the-art multi-frequency multi-dimensional pulsed electron paramagnetic resonance (EPR) spectroscopy methods.

Significant Achievements 2007-2009:

(1). In a ground-breaking development, we have unambiguously identified the substrate water molecules that are bound to the catalytic $\text{Mn}_4\text{Ca-oxo}$ cluster of photosystem II. This provides, for the first time, a direct window into the activation and catalysis of bound water molecules in the solar water oxidation reaction of photosystem II.

(2). We have recently determined the magnetic couplings to the ^{14}N atoms of surrounding amino acid residues in the S_2 state of the oxygen-evolving complex (OEC) of PSII. We utilize multi-dimensional hyperfine sub-level correlation (HYSCORE) difference spectroscopy to facilitate unambiguous assignments of the spectral features and identify at least three separate ^{14}N atoms that are interacting with the $\text{Mn}_4\text{Ca-oxo}$ cluster in the S_2 state (Figure 1). The mechanism of water

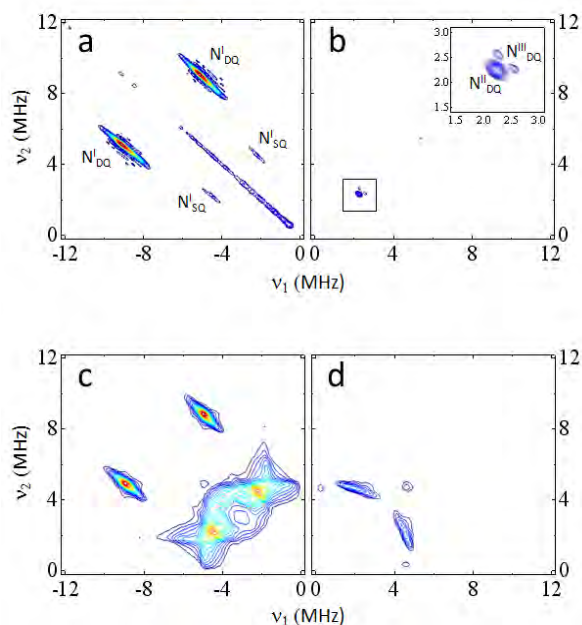

FIGURE 1. The contour plots of the (a) (-,+) quadrant and (b) (+,+) quadrant of the 2D HYSCORE spectrum, obtained as the difference between two spectra of intact PSII with OEC trapped in S_2 and S_1 states, (c) the (-,+) quadrant and (d) the (+,+) quadrant of the simulated 2D HYSCORE spectrum for the ^{14}N nucleus, N^1 , which is strongly interacting with the $\text{Mn}_4\text{Ca-oxo}$ cluster in the S_2 state of PSII. The magnetic parameters obtained from the spectral simulations identify at least three separate ^{14}N atoms of surrounding amino acid residues in the OEC that are interacting with the $\text{Mn}_4\text{Ca-oxo}$ cluster in the S_2 state.

oxidation in the OEC has been a subject of intense interest. It is suggested that the binding and activation of the substrate water molecules at the Mn₄Ca-oxo cluster in the OEC of PSII is facilitated by participating amino acid residues that could be ligated to the catalytic cluster. However, despite extensive investigations there is limited knowledge (and consensus) of the protein environment that surrounds the Mn₄Ca-oxo catalytic cluster. The present study provides direct evidence for the participation of key amino acid residues in the solar water oxidation reaction of PSII and identifies previously unknown ligands to the Mn₄Ca-oxo cluster.

(3). We are conducting a high-resolution structural comparison of Ca²⁺- and Sr²⁺-containing PSII using multi-dimensional HYSCORE spectroscopy to elucidate the role of the Ca²⁺ ion cofactor in the solar water oxidation reaction.

(4). We have detailed the individual steps of the highly efficient proton-coupled electron transfer reactions mediated by the redox-active tyrosine residue, Y_D[•], of photosystem II. This study provides structural snapshots of the PCET intermediates of Y_D[•] and enables a mechanistic blueprint for biological proton-coupled electron transfer processes in energy transduction.

(5). We have conducted detailed multi-frequency multi-dimensional EPR spectroscopy and differential pulsed voltammetry studies on an extensive library of benzoquinone models that provide unique insight into the tuning and regulation of charge transfer by quinone cofactors. We are presently extending these investigations to include the study of the primary and secondary quinone cofactors of photosystem II.

Science Objectives for 2009-2010:

Thus far, we have detailed the environment of the catalytic Mn₄Ca-oxo cluster and the redox-active tyrosine and primary quinone cofactors of PSII. We are expanding the initial studies to include site-directed mutagenesis to engineer PSII in which the environment of these key cofactors that are participating in the solar water oxidation has been modified to alter the efficiency of PCET reactions. Our goal is to better understand the role of the protein environment in determining the functional properties of the PCET cofactors of PSII. These studies will also investigate the tuning of the secondary quinone cofactor of PSII.

In addition to developing multi-frequency multi-dimensional pulsed EPR methods for the study of PSII, we are also embarking on solids NMR investigations to map the structure and dynamics of the tyrosine and quinone cofactors of PSII. This will enable the direct determination of structural parameters, protonation states, hydrogen-bonding interactions and dynamics of these cofactors and provide valuable insight into the functional tuning of the PCET cofactors of PSII.

References to Work Supported by this Project 2007-2009:

1. C.-I. Lee, K. V. Lakshmi and G. W. Brudvig (2007) *Biochemistry* 46, 3211.
2. M. Kumar, V. N. Singh, B. R. Mehta, F. Singh, K. V. Lakshmi and J. P. Singh (2008) *Appl. Phys. Lett.* 92, 171907.
3. M. Kumar, R. Chatterjee, S. Milikisiyants, B. R. Mehta and J. P. Singh, F. Singh and K. V. Lakshmi (2009) *Appl. Phys. Lett.*, 95, 13102.
4. A. Weyers, R. Chatterjee, S. Milikisiyants and K. V. Lakshmi (2009) *J. Phys. Chem. B*, Manuscript in Press.
5. A. Weyers, R. Chatterjee, S. Milikisiyants, O. G. Poluektov and K. V. Lakshmi (2009) *J. Phys. Chem. B*, Manuscript Submitted.
6. B. Jagannathan, S. Dekat, J. H. Golbeck and K. V. Lakshmi (2009) *Biochemistry*, Manuscript Submitted.
7. S. Milikisiyants, R. Chatterjee, A. Weyers, A. Meenaghan and K. V. Lakshmi (2009) *J. Amer. Chem. Soc.*, Manuscript Submitted.
8. R. Chatterjee, A. Weyers, A. Meenaghan, A. Schwendeman, S. Milikisiyants, C. -I. Lee, A. M. Wagner, O. G. Poluektov and K. V. Lakshmi (2009) *J. Amer. Chem. Soc.*, Manuscript in Preparation.
9. S. Milikisiyants, A. Schwendeman, A. Meenaghan, A. Weyers, S. Dekat, R. Chatterjee and K. V. Lakshmi (2009) *Science*, Manuscript in Preparation.
10. R. Chatterjee, A. Weyers, S. Milikisiyants, O. G. Poluektov and K. V. Lakshmi (2009) *J. Phys. Chem. B*, Manuscript in Preparation.

Session II

Genome-wide identification of hormone-regulated transcriptional targets mediating growth and defense response pathways in *Arabidopsis*

Joseph R. Ecker, Principal Investigator
 Katherine Chang, Graduate Research Associate

Plant Biology Laboratory, The Salk Institute for Biological Studies Email: ecker@salk.edu;
 Web: <http://pbio.salk.edu/pbioe/>

Overall research goals: The long-term goal of this research to understand the molecular mechanisms governing hormone-regulated growth responses in plants. In particular, we aim to identify and dissect the transcriptional regulatory networks controlling growth responses mediated by plant hormones and to understand how their interactions are affected by environmental cues. Our initial model for methods development is the identification and analysis of direct targets of EIN3/EIL transcription factors; these are the master regulators of ethylene-mediated growth and defence responses in all plants.

The near-term research objectives are to: 1: Identify transcriptional targets specific to the hormone responses using ChIP-Seq. 2: Validate the role of transcription factor binding in the regulation of hormone response genes by transcriptional profiling using RNA-seq. 3. Identification the points of transcriptional cross-talk between hormone and light signalling pathways by combining transcription factor and protein: protein interaction networks.

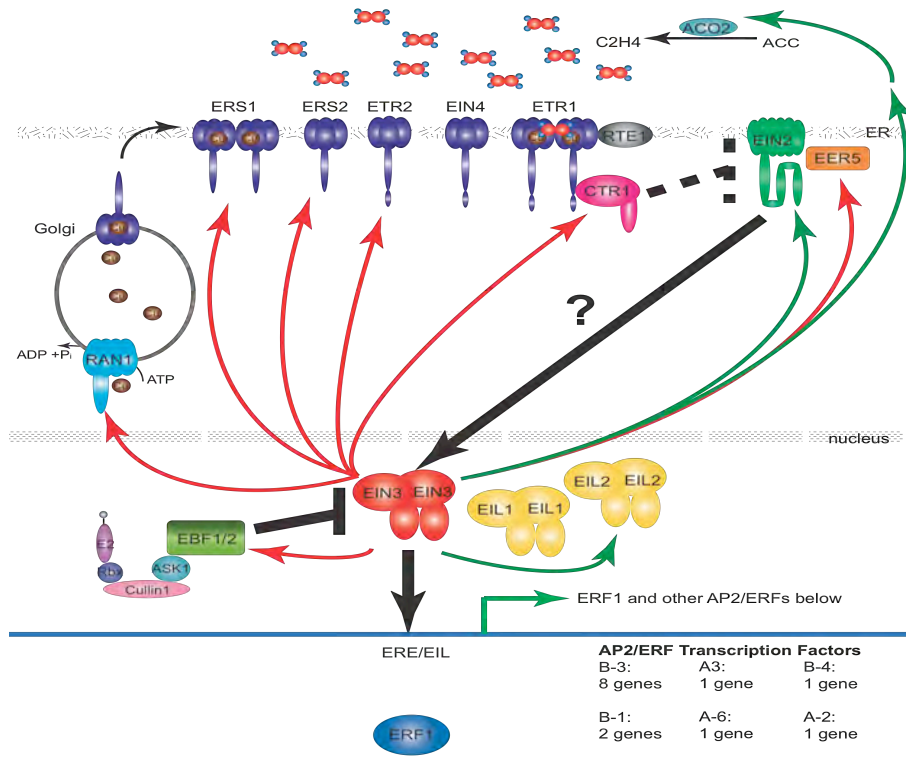

Figure 1. Transcriptional feedback regulation in the ethylene-signaling pathway. Both positive (green) and negative (red) ethylene signaling pathway component were found to be direct targets of EIN3, the master transcriptional regulator of ethylene responses in all plants. (Chang, Qiao and Ecker, in preparation)

Significant achievements 2008-2009: Initial investigations have utilized anti-EIN3 antibodies to carryout chromatin immunoprecipitation sequencing (ChIP-Seq) in Arabidopsis seedlings. EIN3 ChIP-Seq experiments have been carried out in triplicate for wild type and *ein3-1* mutant etiolated seedling treated for 4 hrs with 10-ppm ethylene. Approx. 350 significant EIN3 binding sites were identified genome wide with high reproducibility in both biological and technical replicate experiments. Consensus binding motifs were identified and validated. Comparison with genome-tiling array-based transcriptional profiling revealed that RNA levels for a significant number of EIN3 targets are rapidly affected by ethylene. Analysis of genes associated with EIN3-binding sites revealed that nearly all of the known components of the ethylene-signaling pathway are direct targets, suggesting significant feedback regulation of the pathway (Figure 1). In addition, many receptors and master regulatory transcription factors for the other hormone (GA, BR, cytokinin, auxin, etc) and light response pathways are also direct transcriptional targets of EIN3. These studies reveal that substantial fine-tuning of nearly all growth signaling pathways occurs as the direct consequence of a change in the level of a single hormone.

Science objectives for 2009-2010:

- To further confirm validity of the EIN3 targets specific to the ethylene transcriptional response, time course studies for both EIN3 binding (ChIP-Seq) and transcription (RNA-Seq) induced by ethylene will be performed on the same set of samples. These kinetic analyses will aid in determining if/when EIN3 binding affects transcription of targets, and aid in determining causality. The ethylene treatment time course points have been chosen based on the most rapid ethylene response known-inhibition of seedling growth.
- Direct assay of protein levels of several EIN3 putative targets will test whether EIN3 binding has a function in the feed back/forward regulation of ethylene response pathway components.
- We will integrate the EIN3 transcriptional response network with our first generation Arabidopsis protein:protein interaction network http://interactome.dfc.harvard.edu/A_thaliana/index.php. This will likely reveal additional components of the network that can then be genetically tested using our unmutant collection of T-DNA insertion mutations <http://methylo.me.salk.edu/cgi-bin/homozygotes.cgi>.

References to other work supported by this project 2007-2009:

1. Endres, M.W., Gregory, B.D., Gao, Z., Wahba-Foreman, A., Mlotshwa, S., Ge, X., Pruss, G.J., Ecker, J.R.*, Bowman, L.H.*, and Vance, V.* A novel regulatory circuit connects antiviral silencing to other plant defense pathways; **Submitted**, * co-corresponding authors
2. Liljegren, S. J., Leslie, M. E., Darnielle, L., Lewis, M. W., Taylor, S. M., Luo, R., Geldner, N., Chory, J., Randazzo, P. A., Yanofsky, M. F., and Ecker, J. R. (2009). Regulation of membrane trafficking and organ separation by the NEVERSHED ARF-GAP protein. **Development** 136, 1909-1918.
3. Lister, R., Gregory, B. D., and Ecker, J. R. (2009). Next is now: new technologies for sequencing of genomes, transcriptomes, and beyond. **Curr Opin Plant Biol** 12, 107-118.
4. Lister, R., and Ecker, J. R. (2009). Finding the fifth base: genome-wide sequencing of cytosine methylation. **Genome Research** 19, 959-966.
5. Lister, R., O'Malley, R. C., Tonti-Filippini, J., Gregory, B. D., Berry, C. C., Millar, A. H., and Ecker, J. R. (2008). Highly integrated single-base resolution maps of the epigenome in Arabidopsis. **Cell** 133, 523-536.
6. Gregory, B. D., Yazaki, J., and Ecker, J. R. (2008). Utilizing tiling microarrays for whole-genome analysis in plants. **Plant J** 53, 636-644.
7. Gregory, B. D., O'Malley, R. C., Lister, R., Urich, M. A., Tonti-Filippini, J., Chen, H., Millar, A. H., and Ecker, J. R. (2008). A link between RNA metabolism and silencing affecting Arabidopsis development. **Developmental Cell** 14, 854-866.
8. Yazaki, J., Gregory, B. D., and Ecker, J. R. (2007). Mapping the genome landscape using tiling array technology. **Curr Opin Plant Biol** 10, 534-542

Regulation of Plant Cells, Cell Walls, and Development by Mechanical Signals

Elliot M. Meyerowitz, Principal Investigator

M/C 156-29 Division of Biology, California Institute of Technology, Pasadena, CA 91125, USA

Email: meyerow@caltech.edu; Web: <http://www.its.caltech.edu/~plantlab/>

Overall research goals: The goal of the proposed research is to establish a model for the effects of physical forces on cellular behavior in the shoot apical meristems of growing plants, and at the same time to explore the hypothesis that physical forces play a direct role in auxin flow via an effect on subcellular location of PIN auxin efflux carriers. The basis of this work is earlier work in which we and collaborators developed methods for live imaging of cell expansion, cell division, gene expression domains, and subcellular location of proteins in the *Arabidopsis* shoot apical meristem, and used this information to develop a mechanistic hypothesis for the origin of the phyllotactic pattern, the spiral pattern in which leaves and flowers originate around the shoot apical meristem. The model is a mathematical model for the dynamics of auxin flow in the meristem, based on observations of auxin reporter genes and PIN1 localization. When implemented as a computer program, it reproduces in detail the flow of the plant hormone auxin in the shoot apical meristem. As auxin at high local concentration induces new leaf and flower primordia, the model shows how the plant produces the phyllotactic pattern. This phyllotaxis model lacks a mechanistic explanation for the ability of a cell to sense the auxin concentration of its neighbors, which is an experimentally demonstrated part of the model. We hypothesize that the auxin signal is transmitted physically, by a cell sensing the auxin-induced expansion of its neighbors, and we therefore need to understand how plant cells respond to physical stress. Our recent work shows that stress regulates microtubule behavior, and as microtubules regulate cell wall deposition and cell division planes, we are extending the model beyond auxin flow to include planes of cell division, directions of cellulose deposition, and cell expansion. We are creating integrated models that include physical as well as chemical signaling between meristem cells, so as to obtain a computational model that reproduces all of the activities of the meristem.

Significant achievements 2007-2009: We studied the influence of physical forces on meristem cells in two ways. First was by a detailed study of stretch-activated channels in *Arabidopsis*, which led to cloning of a gene family coding for the channels, and demonstration that they code for stretch-activated channels detected by patch clamping of root-derived protoplasts. Mutant studies have not, however, shown that they are involved in meristematic cell responses. The second approach was to do live imaging of cortical microtubule arrays in meristems and to show that they are aligned parallel to the predicted principle direction of stress using pressure-vessel, spring, and finite element method physical models of the meristem. We have observed untreated meristems, meristems where cells and groups of cells have been laser-ablated, and meristems compressed in a micro-vise. We have looked at meristems in which the PIN1 auxin efflux carrier is labeled and found a general correspondence between its subcellular location and the direction of the microtubule array (and therefore with the principle direction of stress). We have also created new high-resolution live images of cells and cell division patterns in the meristem to create templates for further models, and have used them to develop a predictive mathematical model for the plane of new cell divisions. As division plane is thought to be specified by the microtubule array, this is a first step in correlating physical stresses on cells with their division behavior.

Science objectives for 2009-2010:

- We plan to complete the observations of PIN1 location in meristems compressed in a micro-vise and after different types of laser ablation of cells, to study the relation of stress with PIN1 location, and therefore with auxin flow.
- We will extend the finite element model of stress in the meristem to include rules for the movement of PIN1 to different parts of the plasma membrane depending on stress, and will see which if any of several possible sets of movement rules can reproduce the experimental findings.

- We will use the new high-resolution images and image segmentation methods to follow the growth of meristems with each cell tracked, and to continue to develop predictive models for the plane of new cell divisions based on parameters of cell shape, expansion, size, and stress.
- We will begin to extend the time of live image observations of meristems in which microtubules are labeled to learn how cell division planes respond to physical treatments that change the orientation of the microtubule array.

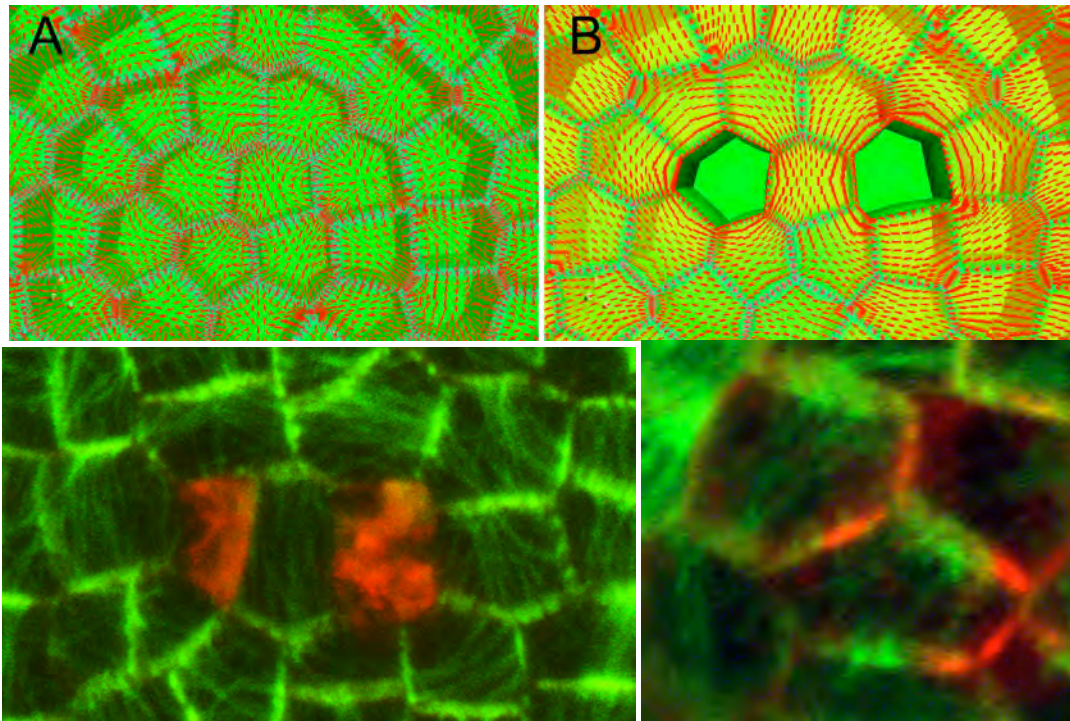

Figure 1. Panels A and B show finite element method models showing principle firection of stress in the cell walls of shoot apical meristem cells at the dome of the meristem before (A) and after (B) two cells are removed. Lower panels: on the left is an experiment testing the realignment of microtubules after a two-cell ablation as in B (ablated cells stained red with propidium iodide), demonstrating that the microtubules (green) align parallel to predicted principle directions of stress. The lower right panel shows meristem cells double-labeled, with microtubules in green and PIN1 auxin efflux carrier protein in red, indicating that the subcellular distribution of PIN1 correlates with cortical microtubule orientation. A, B and lower left panel modified from Supplementary Figure 8 of Hamant et al. (2008).

References to work supported by this project 2007-2009:

1. Michniewicz, M., Zago, M.K., Abas, L., Weijers, D., Schweighofer, A., Meskiene, I., Heisler, M.G., Ohno, C., Zhang, J., Huang, F., Schwab, R., Weigel, D., Meyerowitz, E.M., Luschnig, C., Offringa, R. and Friml, J. (2007) Phosphorylation-dependent apical-basal targeting of PIN regulated by antagonistic activities of Phosphatase 2A and PINOID kinase. *Cell* **130**, 1044-1056.
2. Reddy, G.V., Gordon, S.P. and Meyerowitz, E.M. (2007) Unravelling developmental dynamics: transient intervention and live imaging in plants. *Nature Reviews Molecular Cell Biology* **8**, 491-501.
3. Haswell, E.S., Peyronnet, R., Barbier-Brygoo, H., Meyerowitz, E.M. and Frachisse, J.M. (2008) Two MscS homologs provide mechanosensitive channel activities in the Arabidopsis root. *Curr. Biol.* **18**, 730-734.
4. Hamant O., Heisler, M., Jönsson, H., Krupinski, P., Uyttewaal, M., Bokov, P., Corson, F., Sahlin, P., Boudaoud, A., Meyerowitz, E., Couder, Y. and Traas, J. (2008) Developmental patterning by mechanical signals in *Arabidopsis*. *Science* **322**, 1650-1655.

Molecular and Physiological Functions of Plant Glutamate Receptors

Edgar P. Spalding, Principal Investigator

Eric Vincill, Postdoctoral Research Associate

Department of Botany, University of Wisconsin, 430 Lincoln Dr., Madison, WI 53706

Email: spalding@wisc.edu; web: <http://www.botany.wisc.edu/spalding/bio.htm>

Overall research goals: Plant genomes contain a family of genes predicted to encode ligand-gated ion channels similar to the glutamate receptors that mediate rapid signaling between cells in the central nervous system of animals. Our objectives are to test the hypothesis that Arabidopsis glutamate receptor-like (GLR) molecules function as extracellular amino acid-gated calcium channels, and to learn what role they play in the physiology of the plant. The working cell/molecular model supported by progress to date is that at least some members of the 20-gene *GLR* family encode Ca^{2+} -permeable channels at the plasma membrane that can be gated (triggered to open) by six different amino acids and even the tri-peptide glutathione. The working whole-plant model not yet tested is that GLR-mediated Ca^{2+} signaling may be related to the sensing of photosynthetically-fixed carbon compounds exuded in large amounts into the rhizosphere.

Significant achievements 2007-2009: We have genetically linked the activation of GLR3.3 and GLR3.4 by micro-to-millimolar concentrations of amino acids to the observed membrane potential change (depolarization) observed in roots and hypocotyls. **As shown in Figure 1A**, seedlings homozygous for knockout alleles of *GLR3.3* do not display the large transient change in membrane potential triggered in the wild type by six different amino acids. We refer to these six amino acids as potent. The other 14 common amino acids are without effect in wild type or mutant. The shown measurements were made in hypocotyls of light-grown Arabidopsis seedlings though the same result was obtained in roots. **Shown in Figure 1B** is the rise in intracellular Ca^{2+} triggered by a potent amino acid in the root of an Arabidopsis seedling expressing a fluorescent protein Ca^{2+} indicator. The response is not observed in *glr3.3* mutants. Fully convincing evidence that GLR3.3 is an amino acid-gated channel that admits Ca^{2+} into the cytoplasm was obtained when the GLR3.4 cDNA was expressed in a Human Embryonic Kidney (HEK) cell line along with the YC3.6 fluorescent Ca^{2+} indicator protein. **As shown in Figure 1C**, addition of asparagine, a potent amino acid, triggered a large, transient rise in cytoplasmic Ca^{2+} in the GLR3.4-expressing HEK cell (and not in cells transformed only with the Ca^{2+} indicator).

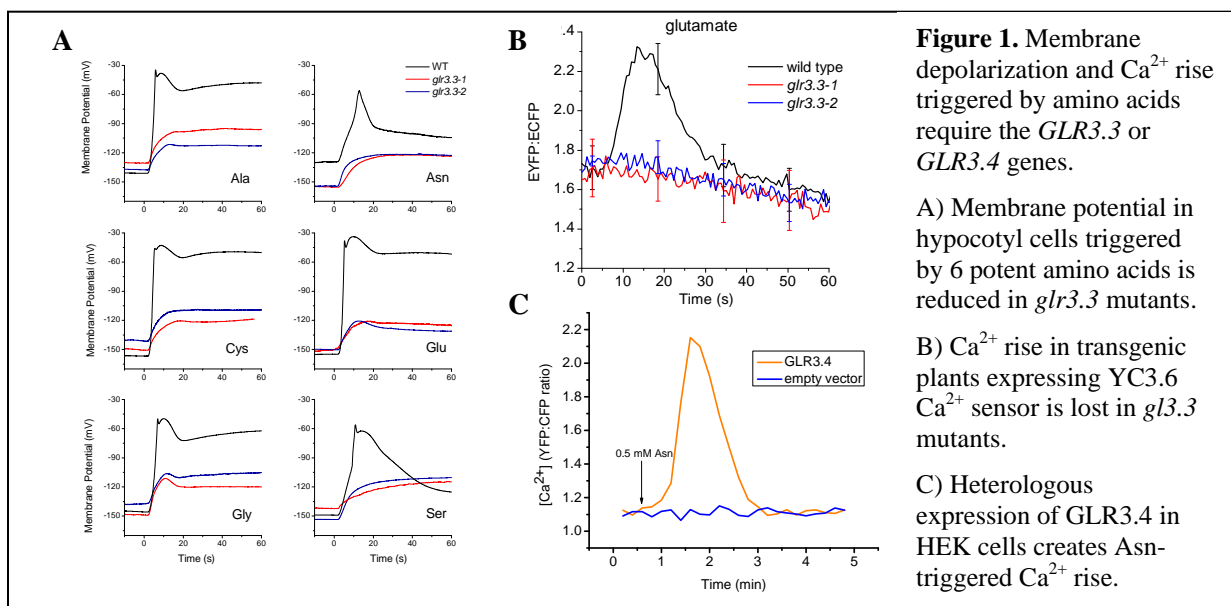

The *glr3.3* mutant, which displays the cell-physiology phenotypes summarized above was used as the test case for the machine-vision phenotyping tools we are developing with NSF support. The roots of *glr3.3* and wild type seedlings were monitored every 5 min with CCD cameras and the resulting image series subjected to automated mathematical analysis. The subtle *glr3.3* phenotype was identified computationally and shown to result from a difference in root tip acceleration during gravitropism. One function of GLR3.3-mediated Ca^{2+} signaling may be to fine-tune root growth responses to environmental signals.

Science objectives for 2009-2010:

- We need to measure ionic currents in the HEK cells by patch clamping to determine the ionic selectivity of the GLR channels. Are GLR3.3 and GLR3.4 Ca^{2+} -selective? What about the other family members?
- We need to determine the *in planta* localization of the proteins for which we have functional evidence (GLR3.3 and GLR3.4) at the organ, tissue, and subcellular localization. We are in the process of making GLR-GFP fusions. The GLR3.4-GFP fusion is functional in HEK cells.
- We need to determine if organic compounds exuded by roots affect GLR channel function in a way that may make them candidates for rhizosphere carbon sensors. The HEK cell expression system will be used to test for effects of malate, for example, on the glutamate-gated Ca^{2+} signal.
- We need to obtain protein structure information for the extracellular ligand-binding domain. We want to express the N-terminus and obtain either its solution NMR or x-ray crystal structure to understand how the channels can be responsive to six structurally diverse amino acids.

References to work supported by this project 2007-2009:

1. Stephens NR, Qi Z, Spalding EP (2008) Glutamate receptor subtypes evidenced by differences in desensitization and dependence on the *GLR3.3* and *GLR3.4* genes. *Plant Physiology* **146**: 529-538
2. Durham Brooks TL, Miller ND, Spalding EP (2009) Plasticity of Arabidopsis root gravitropism throughout a multi-dimensional condition space quantified by automated image analysis. *Plant Physiology* (accepted pending very minor revision)

“Molecular Genetic Analysis of Activation-Tagged Transcription Factors Involved in Photomorphogenesis”

Michael M. Neff, Principal Investigator

Jiwen Qiu, Postdoctoral Research Associate

Jason Ward, Ph.D. Student

Ian Street, Ph.D. Student

Jianfei Zhao, Ph.D. Student

Department of Crop and Soil Sciences, P.O. Box 646420

Washington State University, Pullman, WA 99164-6420

Email: mmneff@wsu.edu Web: <http://css.wsu.edu/people/faculty/crops/Neff.htm>

Overall research goals: Our current DOE-funded project focuses on understanding how specific DNA binding proteins regulate plant photomorphogenesis, size and stature. Each of these genes was originally identified in a *suppressor of phytochrome B* (*SOB*) mutant screen. Based on our preliminary photobiological and genetic analysis of the *sob1-D* mutant, we hypothesized that OBP3 is a transcription factor involved in both phytochrome and cryptochrome-mediated signal transduction. In addition, we hypothesized that OBP3 is involved in auxin signaling and root development. Based on our preliminary photobiological and genetic analysis of the *sob2-D* mutant, we also hypothesized that a related gene, *LEP*, is involved in hormone signaling and seedling development. Identification and primary analysis of *sob3-D* has led us to expand the scope of our research to include biochemical and molecular-genetic analysis of the AT-hook nuclear localizing (AHL) gene family in Arabidopsis. The overall goal is to understand the molecular/genetic mechanisms by which these DNA-binding proteins regulate size and stature in plants, focusing on those that could be used to increase energy acquisition and biomass.

Significant achievements: Jason Ward, a former graduate student in my lab at Washington University, completed the bulk of the first specific aim from this grant resulting in a publication in *The Plant Cell* (Ward et al. 2005). In addition, Jason Ward tested the hypothesis that OBP3 is involved in auxin signaling. After completing all of the proposed experiments in the second specific aim of this grant, it appears that there is no direct connection between auxin signaling and OBP3. With this in mind, we are no longer pursuing this line of experiments. Jason Ward also completed the third specific aim of this grant resulting in an additional publication in *The Plant Cell* (Ward et al. 2006). Since these studies did not show a direct link between *LEP* and photomorphogenesis, we have expanded the focus of our efforts as described below.

Two years ago I moved my research program from Washington University to Washington State University in Pullman, WA. In the interim, Ian Street, another former graduate student in my lab, expanded the scope of this research based on his findings from studies of a DNA-binding protein SOB3/AHL29 and its closest family member ESC/AHL27. These studies resulted in a publication in *The Plant Journal* (Street et al. 2008).

sob3-D over-expressing seedlings have shorter hypocotyls and as adults, develop larger flowers and leaves, and are delayed in senescence compared to wild-type plants. At the nucleotide level, *SOB3* is closely related to *ESCAROLA* (*ESC*), which was identified in an independent activation-tagging screen. *ESC* over-expression also suppresses the *phyB-4* long-hypocotyl phenotype and confers an adult morphology similar to *sob3-D*, suggesting similar functions. Over-expression of other AHL family members also increases biomass and confers delayed senescence and enhance photosynthetic capacity when compared to the wild type. However, the biochemical mechanism leading to these over-expression phenotypes is unknown.

A loss-of-function *SOB3* allele (*sob3-4*) was generated through an EMS intragenic suppressor screen of *sob3-D phyB-4* plants, and this allele was combined with a null allele, disrupting *ESC* (*esc-8*), to examine potential genetic interactions. The *sob3-4 esc-8* double mutant had a long hypocotyl in multiple fluence rates of continuous white, far-red, red and blue, light. *sob3-4 esc-8 phyB-9* and *sob3-4 esc-8 cry-103* triple mutants also had longer hypocotyls than photoreceptor single mutants. In contrast, the *sob3-4 esc-8 phyA-211* triple mutant was the same length as *phyA-211* single mutants. Taken together, these

data demonstrate that *SOB3* and *ESC* act redundantly to modulate hypocotyl growth inhibition in response to light (Street et al. 2008). Jianfei Zhao, a Ph.D. graduate student who joined my lab in the Fall of 2008, and Dr. Jiwen Qiu, a postdoc who joined my lab this past winter will further explore these two genes and related family members as a part of the proposed studies in our renewal application entitled “Biochemical and molecular-genetic analysis of the AT-hook nuclear localizing (AHL) gene family in *Arabidopsis*”.

Science objectives for 2009-2010:

- Examine protein-protein interaction among specific members of the AHL gene family.
- Investigate the roles of the PPC domain in protein-protein interaction and biological function.
- Determine the biochemical function of the AT-hook domain in *SOB3* and other family members.
- Utilize genetic approaches to determine the roles of *SOB3*, *ESC* and other *AHL* family members in modulating plant stature and development.

References to work supported by this project:

Manuscripts Acknowledging Direct/Primary Supported from DOE

(***Bold/Italic names*** indicate authors who were graduate students. **Bold names** indicate authors who were undergraduate students):

1. **Ward JM, Cufu CA, Denzel MA** and Neff MM (2005) The Dof transcription factor, OBP3, modulates phytochrome and cryptochrome signaling in *Arabidopsis*. **Plant Cell** 17 475-485
2. **Ward JM, Smith AM, Shah PK, Gallanti SE, Yi H, Demianski AJ**, van der Graaff E, Keller B and Neff MM (2006) A New Role for the AP2 Transcription Factor, LEP, in Gibberellin-Induced Germination is Revealed by the Mis-Expression of a Homologous Gene, *SOB2/DRN-like*. **Plant Cell** 18 29-39
3. **Street IH, Shah PK, Smith AM, Avery N**, and Neff MM (2008) The AT-Hook Containing Proteins *SOB3/AHL29* and *ESC/AHL27* are Negative Modulators of Hypocotyl Growth in *Arabidopsis*. **Plant Journal** 54 1-14

Manuscripts Indirectly Supported By DOE

4. **Turk EM**, Fujioka S, Seto H, Shimada Y, Takatsuto S, Yoshida S, Wang H, **Torres QI, Ward JM, Murthy G**, Zhang J, Walker JC and Neff MM (2005) *BAS1* and *SOB7* Act Redundantly to Modulate *Arabidopsis* Photomorphogenesis via Unique Brassinosteroid Inactivation Mechanisms. **Plant Journal** 42 23-34
5. Zhang J, **Wrage EL**, Vankova R, Malbeck J, and Neff MM (2006) Over-expression of *SOB5* suggests the involvement of a novel plant protein in cytokinin-mediated development. **Plant Journal** 46 834-848
6. Neff MM, **Street IH, Turk EM, Ward JM** (2006) Chapter 21: Interaction of light and hormone signaling to mediate photomorphogenesis In E. Schäfer, F. Nagy, eds, **Photomorphogenesis in Plants and Bacteria 3rd Ed.**, 439-473. Springer, Netherlands
7. Nemri A, Neff MM, Burrell M, Jones JDG and Studholme DJ (2007) Marker development for the genetic study of natural variation in *Arabidopsis thaliana*. **Bioinformatics** 23 3108-3109
8. Chen H, Zhang J, Neff MM, Hong S-W, Deng XW and Xiong L (2008) Integration of light and abscisic acid signaling during seed germination and early seedling development. **Proceedings of the National Academy of Sciences USA** 105 4495-4500
9. Neff MM, **Sanderson L** and **Tedor D** (2009) Light-mediated germination in lettuce seeds: Resurrection of a classic plant physiology lab exercise **The American Biology Teacher** 71 367-370
10. Zhang J, Vankova R, Dobrev PI, Xu Y, Chong K and Neff MM (in review **PLoS One**) *AtSOFL1* and *AtSOFL2* act redundantly as positive modulators of the endogenous content of specific cytokinin levels in *Arabidopsis*.
11. Thornton LE, Rupasinghe S, Peng H, Schuler MA and Neff MM (in review **Plant Molecular Biology**) *Arabidopsis* CYP72C1 is a noncanonical brassinosteroid-inactivating cytochrome P450.

Poster Session I

Photosynthetic Interprotein Electron Transfer

Lisa M. Utschig, Principal Investigator

Oleg G. Poluektov, Lin X.Chen, David M. Tiede, Co-PIs

Jenny V. Lockard, Sergey Milikisiyants, Postdoctoral Research Associates

9700 S. Cass Ave, Argonne National Laboratory (ANL), Argonne, IL 60439

Email: utschig@anl.gov

Overall research goals: Photosynthetic reaction center (RC) proteins are finely tuned molecular systems optimized for solar energy conversion. The primary reaction in RCs involves rapid, sequential electron transfer that results in stable charge separation. Following efficient charge separation, the energy captured is utilized in a series of reactions that ultimately drive the chemical conversion of CO₂ into carbohydrates. Our group has initiated efforts to mimic Nature and make use of the initial light-initiated RC reactions to drive non-native chemical reactions for solar fuels production. To this end, recent work is focused on understanding structure-function relationships in natural photosynthetic systems with the intent of applying this knowledge to the design and optimization of novel biohybrid systems. Specifically, we are developing experimental methods to interrogate native protein docking and electron transfer events that take place subsequent to photoinduced charge-separation in the Photosystem I (PSI) RC. The large membrane PSI protein catalyzes light-driven electron transfer across the thylakoid membrane from plastocyanin located in the lumen to one of two small electron carrier proteins, ferredoxin or flavodoxin, in the stroma. These small proteins then shuttle the reducing equivalents from PSI to several metabolic pathways. Our discovery of native transition metal ion sites on the acceptor docking side of PSI enables us to capitalize on the spectroscopic properties of metal ions and directly probe the stromal region of PSI, PSI-charge carrier protein docking mechanisms, and interprotein electron transfer reactions. Our experimental approach utilizes both specialized “spin-edited” (i.e. samples that involve isotopic labeling and/or native paramagnetic metal ion replacement) samples and multifrequency pulsed electron paramagnetic resonance (EPR) techniques as well as X-ray absorption fine structure (XAFS) spectroscopy.

Significant achievements 2007-2009:

Discovery of Native Metal Ion Sites in PSI. Using a combination of bioinorganic and spectroscopic techniques, we have examined the intrinsic surface Zn²⁺ and Cu²⁺ sites of PSI. Two-dimensional hyperfine sublevel correlation (HYSCORE) spectroscopy shows coupling to the so-called remote nitrogen of a single histidine coordinated to one of the Cu²⁺ centers. EPR and X-ray absorption fine structure (XAFS) studies of 2Cu-PSI complexes prove the direct interaction of ferredoxin with the Cu²⁺ centers on PSI, establishing the location of native metal sites on the ferredoxin docking side of PSI. On the basis of these spectroscopic results and previously reported site-directed mutagenesis studies, inspection of the PSI crystal structure reveals a cluster of three highly conserved residues, His(D95), Glu(D103), and Asp(C23), as a likely Cu²⁺ binding site. (Figure 1)

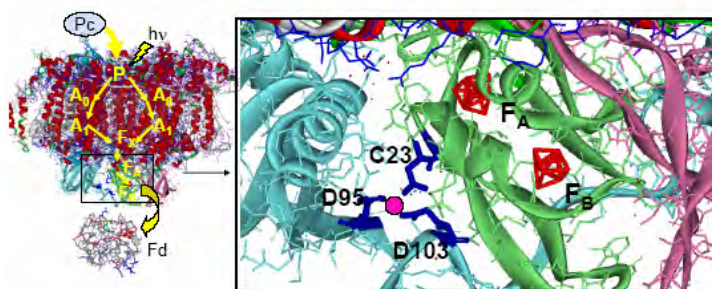

Figure 1 Left: Photosystem I reaction center (PDB 1JB0) showing the photo-initiated sequential electron transfer pathway from the primary donor P to the terminal electron acceptors, F_A and F_B. Ferredoxin (Fd) (PDB 1A70) accepts the light-generated electron from PSI; plastocyanin (Pc) reduces the oxidized donor, P⁺. Right: Enlargement of the stromal subunits showing a proposed Cu binding site ligands in PSI. A putative Cu atom is illustrated.

Conformational Changes in PSI. We are using Cu^{2+} ($3d^9$, $S = 1/2$) to directly probe dynamic features of the peptide environment surrounding the metal site, (i.e. response to protein binding and electron transfer) using pulsed EPR experiments of specifically-prepared isotopically labeled samples. XAFS experiments of Cu^{1+} sites provide direct evidence of light-induced structural changes in the stromal region of PSI following charge separation. We are correlating these conformational changes to acceptor protein binding.

Science Objectives 2009-2010:

- We are designing experimental systems to look in detail at PSI interprotein interactions. We are interested in looking at the native PSI reduction of ferredoxin and flavodoxin in solution using freeze-trap methods and EPR spectroscopy as well as the metal ion-induced positioning of these carrier proteins. Importantly, we have fully deuterated flavodoxin. Deuteration effectively narrows the line width of the flavin mononucleotide radical such that the EPR signals of reduced flavodoxin and PSI can be resolved at both low (X-band, 9GHz) and high field (D-band, 130 GHz), enabling us to examine interprotein ET reactions and protein interactions with advanced time-resolved pulsed HF EPR methodologies. Initial experiments already show some surprising results with regards to both bidirectional and low temperature interprotein ET.
- Our fundamental studies of metal sites on PSI are generating ideas about how and where to link catalysts to PSI. Bioinorganic and acceptor protein-based strategies to form biohybrid complexes are being developed.

References to work supported by this project 2007-2009:

1. O. G. Poluektov, L. M. Utschig, M. C. Thurnauer, and G. Kothe "Exploring Hyperfine Interactions in Spin-Correlated Radical Pairs from Photosynthetic Proteins: High-Frequency ENDOR and Quantum Beat Oscillations" *Appl. Magn. Reson.*, **2007**, *31* (1-2), 123-143.
2. U. Heinen, L. M. Utschig, O. G. Poluektov, G. Link, E. Ohmes, and G. Kothe "Structure of the Charge Separated State $\text{P}^+_{865}\text{Q}^-_{\text{A}}$ in the Photosynthetic Reaction Centers of *Rhodobacter sphaeroides* by Quantum Beat Oscillations and High-Field Electron Paramagnetic Resonance: Evidence for Light-Induced Q^-_{A} Reorientation" *J. Am. Chem. Soc.*, **2007**, *129*, 15935-15946.
3. L. Huang, G. P., Wiederrecht, L. M. Utschig, S. L. Schlesselman, C. Xydis, P. D. Laible, D. K. Hanson, D. M. Tiede, "Correlating Ultrafast Function with Structure in Single Crystals of the Photosynthetic Reaction Center" *Biochemistry*, **2008**, *47*, 11387-11389.
4. L. M. Utschig, S. D. Chemerisov, D. M. Tiede, and O. G. Poluektov "Electron Paramagnetic Resonance Study of Radiation Damage in Photosynthetic Reaction Center Crystals" *Biochemistry*, **2008**, *47*, 9251-9257.
5. L. M. Utschig, L. X. Chen, and O. G. Poluektov "Discovery of Native Metal Ion Sites Located on the Ferredoxin Docking Side of Photosystem I" *Biochemistry*, **2008**, *47*, 3671-3676.
6. O. G. Poluektov and L. M. Utschig "Protein Environments and Electron Transfer Processes Probed with High-Frequency ENDOR" In *The Purple Phototrophic Bacteria. Advances in Photosynthesis and Respiration*, C. N. Hunter, F. Daldal, M. C. Thurnauer, and J. T. Beatty, Eds., **2009**, Vol 28, pp. 155-179, Springer, Dordrecht, The Netherlands.
7. O. G. Poluektov, S. V. Paschenko, and L. M. Utschig, "Spin-Dynamics of the Spin-Correlated Radical Pair in Photosystem I. Pulsed Time-Resolved EPR at High Magnetic Field." *Phys. Chem. Chem. Phys.* **2009**, *11*, 6750-6756.
8. L. M. Utschig, S. D. Dalosto, M. C. Thurnauer, and O. G. Poluektov, "The Surface Metal Site in *Blc. Viridis* Photosynthetic Bacterial Reaction Centers: Cu^{2+} as a Probe of Structure, Location, and Flexibility" *Appl. Magn. Reson.* **2009**, submitted

Chlorophyll synthesis and stability in cyanobacteria

Willem F.J. Vermaas, PI

Daniel Brune, research associate

Sawsan W. Hamad, postdoc

Cheng Yao, graduate student

School of Life Sciences, Arizona State University, Tempe, AZ 85287-4501

Email: wim@asu.edu

Overall research goals:

A main objective of this project is to understand the interrelationships between chlorophyll (and its synthesis), chlorophyll-binding proteins and thylakoid membrane formation. All three components are critical to photosynthetic electron transfer, but only fragments of their interrelationships are understood. Using stable-isotope labeling followed by mass spectrometry we are monitoring the rate of disappearance of “old” chlorophyll and chlorophyll-binding proteins, particularly those associated with photosystem II, and we can measure the rate of biosynthesis of “new” pigment and proteins. For these and other studies we use the cyanobacterium *Synechocystis* sp. PCC 6803, which easily takes up relevant stable-isotope-labeled compounds and for which we have generated many useful mutants.

A related goal is to connect biosynthetic information on chlorophyll and chlorophyll-binding proteins to the formation of thylakoid membranes. Very little is known about how thylakoid membranes, the site where chlorophyll and chlorophyll-binding proteins are located, are formed. In a conditional chlorophyll biosynthesis mutant that does not synthesize chlorophyll in darkness but does so in the light, after growth in essential darkness and depletion of chlorophyll, thylakoids are largely absent, but thylakoids form well within an hour after cells are switched to light. Synthesis of a full chlorophyll complement in the light takes much longer, suggesting that chlorophyll biosynthesis may be involved but is not the sole driver of thylakoid biosynthesis. One protein that may be relevant in this respect is VIPP-1 (vesicle-inducing plastid protein-1), which upon overexpression causes an increase the number of thylakoid membranes per cell. Therefore, the biosynthesis of thylakoids, chlorophyll and the photosynthetic apparatus is a central focus of our research. Understanding this will also help in synthetic biology approaches to generate an organism serving as a self-renewing, solar-driven biocatalyst for producing green petroleum substitutes.

Significant achievements 2007-2009:

- We have developed and refined methods for following pigment biosynthesis and degradation (Vavilin and Vermaas, 2007; Vavilin et al., 2007).
- At least some of the SCPs (small Cab-like proteins) in *Synechocystis* are associated with photosystem II that is being repaired, but there is no evidence for SCPs being structural components required for a functioning photosystem II complex (Yao et al., 2007; Kufryk et al., 2008).
- At least some of the SCPs also appear to be involved with early (pre-amino levulinic acid) steps in chlorophyll biosynthesis, and may have a regulatory role in this process.
- Following the fate of “old” and “new” pigments and proteins has demonstrated the presence of partially assembled photosystem II complexes that appear to await incorporation of the reaction center proteins D1 and D2. These partially assembled complexes have a lifetime of

up to 10 hours. The absence of SCPs, which are involved with photosystem II assembly and repair, appears to destabilize this fraction of partially assembled complexes.

- Overexpression of VIPP-1 leads to an increased number of thylakoids per cell, and to the occasional visualization of structures inside the cell that may be important for membrane biosynthesis.

Science objectives for 2009-2010:

- Completion of chlorophyll vs. chlorophyll-binding protein lifetime analysis.
- Identification of the function of Sll1906 by means of deletion analysis; Sll1906 is an apparent orthologue of PucC, which may be involved in (bacterio)chlorophyll transport.
- Clarification of aspects of thylakoid membrane biogenesis, particularly with respect to the function of the VIPP-1 protein and of chlorophyll or light.

References to work supported by this project 2007-2009:

- Yao, D., Kieselbach, T., Komenda, J., Promnares, K., Hernandez-Prieto, M.A., Tichy, M., Vermaas, W., and Funk, C. (2007) Localization of the small CAB-like proteins in photosystem II. *J. Biol. Chem.* **282**, 267-276.
- Rakhimberdieva, M.G., Vavilin, D.V., Vermaas, W.F.J., Elanskaya, I.V., and Karapetyan, N.V. (2007) Phycobilin/chlorophyll excitation equilibration upon carotenoid-induced non-photochemical fluorescence quenching in phycobilisomes of the cyanobacterium *Synechocystis* sp. PCC 6803. *Biochim. Biophys. Acta* **1767**, 757-765.
- Vavilin, D., and Vermaas, W. (2007) Continuous chlorophyll degradation accompanied by chlorophyllide and phytol reutilization for chlorophyll synthesis in *Synechocystis* sp. PCC 6803. *Biochim. Biophys. Acta* **1767**, 920-929.
- Vavilin, D., Yao, D., and Vermaas, W. (2007) Small Cab-like proteins retard degradation of photosystem II-associated chlorophyll in *Synechocystis* sp. PCC 6803: kinetic analysis of pigment labeling with ¹⁵N and ¹³C. *J. Biol. Chem.* **282**, 37660-37668.
- Kufryk, G., Hernandez-Prieto, M., Kieselbach, T., Miranda, H., Vermaas, W., and Funk, C. (2008) Identification of Small CAB-like proteins (SCPs) of *Synechocystis* sp. PCC 6803 in photosystem II. *Photosynth. Res.* **95**, 135-145.
- Hamad, S.W., and Vermaas, W.F.J. (2009) Overexpression of *vipp1* in *Synechocystis* sp. strain PCC 6803 enhances thylakoid membrane content and alters photosystem stoichiometry. In revision.

Studies of Photosynthetic Reaction Centers and Biomimetic Systems

Marilyn Gunner, Principal Investigator

Doug Bruce (Brock U), Victor Batista (Yale U) Co-PIs

Physics Dept CCNY J-419 160 Convent Ave New York NY

Email: gunner@sci.ccny.cuny.edu; Web: <http://www.sci.ccny.cuny.edu/~gunner/>

victor.batista@yale.edu, dbruce@BrockU.ca

Overall research goals: Natural photosynthesis converts light energy into chemical form and ultimately supplies most of the energy required by life on earth. Photosynthetic reaction centers, the sites of primary energy conversion, are large multicomponent complexes of proteins, pigments and electron transport cofactors embedded in a lipid bilayer membrane. These multitasking protein complexes convert solar energy to useful products via proton coupled electron transfer reactions (PCET). They are responsible for photocatalytic O₂ production by water oxidation. There is a wealth of thermodynamic and kinetic data describing their function. However, understanding the underlying mechanisms requires a molecular level analysis that is only possible with computational modeling. To date, rigorous, comprehensive, interpretations of experimental data at the detailed molecular level have been limited by the assumptions inherent in individual computational methods. We are carrying out analysis of Photosystem II by integrating high-quality density functional methods and quantum mechanical/molecular mechanics hybrid methods (**Batista**), molecular dynamics simulations (**Bruce**) and continuum electrostatics/Monte Carlo techniques (**Gunner**). The combination of these state-of-the-art computational approaches is providing understanding of structure-function relations in photosynthetic reaction centers. These insights allow much less ambiguous interpretations of experimental data from biochemical, spectroscopic and mechanistic studies than possible from the vantage point of any single computational techniques. The goal is to elucidate how the photosynthetic proteins facilitate energy conversion, including, the control of redox potentials of key electron transport cofactors, coupling of proton and electron transfer mechanisms, functioning of the unique oxygen evolution complex (OEC) and the potential for dynamic control of electron transport efficiency. The long-term goal is to establish guidelines for the design of biomimetic solar devices and the modification of natural proteins for applications of technological interest. Specific objectives are: (1) to develop and validate structural models of photosystem II; (2) to elucidate the interplay between the protein and cofactors responsible for tuning the thermodynamics and kinetics of proton coupled to electron transfer; and (3) to compare structure-function relations in photosystem I and bacterial reaction centers with those found in photosystem II.

Significant recent achievements:

Benchmarks for analysis of the Oxygen Evolving Complex (OEC). The OEC is a unique μ -oxo-Mn complex with bound Cl⁻ and Ca²⁺. Work has been carried out in the Batista group to validate the method for analysis based on small model systems (1). For example, DFT studies have been made of the coupling of redox and acid base chemistry in the biomimetic oxomanganese complex [Mn^{III}Mn^{IV}(μ -O)₂(H₂O)₂(bpy)₄]²⁺ (bpy = 2,2'-bipyridyl). The results indicate that at pH<1.96, the μ -hydroxo bridge of Mn(III,III) remains protonated upon oxidation of the complex while at pH>1.96 the oxidation of **1** from Mn(III, III) to Mn(III,IV) leads to deprotonation of the di- μ -oxo bridge, a process that is stabilized by 60 mV per unit of pH. Parallel work in the Gunner lab has used Continuum Electrostatics and Monte Carlo sampling

to determine the locations of Cl⁻ bound within proteins and how this varies with pH in locations where Cl⁻ and proton binding is coupled together (5). The Bruce lab is in the process of integrating these efforts, building a full PSII model with a DFT optimized OEC supplied by the Yale group and ionization states of all acidic and basic groups in the entire protein calculated by MCCE.

Science objectives for 2009-2010:

Combined analysis of the OEC of PSII. Having validated the level of theory as applied to Proton Coupled Electron Transfer (PCET) in biomimetic oxomanganese complexes, the studies of PCET in model systems will be extended to the redox/acid-base cofactors in PSII. This will focus on the characterization of redox potentials of our QM/MM model of the OEC and the Y_Z-His complex in PSII. Overall these calculations will aim to establish the interrelationship of the protonation and redox state of the OEC, the stoichiometry and location of bound ions and the protonation of amino acid residues. The impact of the changes in the OEC on the redox potential and pK_as of the Y_Z-His complex, which serves as the oxidant for the OEC, will be examined.

References to work related to project (2008-09):

1. Sproviero, E. M., Newcomer, M. B., Gascon, J. A., Batista, E. R., Brudvig, G. W., and Batista, V. S. (2009) The MoD-QM/MM methodology for structural refinement of photosystem II and other biological macromolecules, *Photosynth Res.* (EPub)
2. Sproviero, E. M., Shinopoulos, K., Gascon, J. A., McEvoy, J. P., Brudvig, G. W., and Batista, V. S. (2008) QM/MM computational studies of substrate water binding to the oxygen-evolving centre of photosystem II, *Philosophical transactions of the Royal Society of London* 363, 1149-1156; discussion 1156.
3. Sproviero, E. M., Gascon, J. A., McEvoy, J. P., Brudvig, G. W., and Batista, V. S. (2008) Quantum mechanics/molecular mechanics study of the catalytic cycle of water splitting in photosystem II, *Journal of the American Chemical Society* 130, 3428-3442.
4. Zheng, Z., and Gunner, M. R. (2009) Analysis of the electrochemistry of hemes with Ems spanning 800 mV, *Proteins* 75, 719-734.
5. Song, Y., and Gunner, M. R. (2009) Using Multi-Conformation Continuum Electrostatics to compare chloride binding motifs in α -amylase, human serum albumin, and Omp32, *J. Mol. Biol.* 387, 840-856.
6. Gunner, M. R., Madeo, J., and Zhu, Z. (2008) Modification of quinone electrochemistry by the proteins in the biological electron transfer chains: examples from photosynthetic reaction centers, *Journal of Bioenergetics and Biomembranes* 40, 509-519.
7. Vassiliev, S., and Bruce, D. (2008) Toward understanding molecular mechanisms of light harvesting and charge separation in photosystem II, *Photosynth Res* 97, 75-89.
8. Poddutoori, P. K., Poddutoori, P., Maiya, B. G., Prasad, T. K., Kandrashkin, Y. E., Vasil'ev, S., Bruce, D., and van der Est, A. (2008) Redox control of photoinduced electron transfer in axial terpyridoxy porphyrin complexes, *Inorganic chemistry* 47, 7512-7522.

Post-Transcriptional Regulation of Ethylene Perception and Signaling in Arabidopsis

G. Eric Schaller, Principal Investigator

Department of Biological Sciences, Dartmouth College, Hanover, NH 03755

Email: george.e.schaller@dartmouth.edu; Web: <http://www.dartmouth.edu/~psl/>

Overall research goals: The simple gas ethylene functions as an endogenous regulator of plant growth and development. Ethylene is perceived in the plant Arabidopsis by a five-member family of receptors related to bacterial histidine kinases. Our overall research goal is to determine how physical interactions within the ethylene receptors regulate signal output. To this end we are currently examining (1) trans-phosphorylation among the receptors, (2) whether conformational information can be propagated in a cooperative manner among the receptors, and (3) the effects of a novel family of proteins that appear to regulate receptor output. These studies will provide fundamental insights into how physical interactions function in coordinating receptor signal output. These studies will also shed light on ethylene signal transduction, which regulates multiple aspects of plant growth and development including plant bio-mass, cell wall composition, and photosynthetic capacity.

Significant achievements 2007-2009: Null mutations were isolated and characterized for the ethylene receptors ETR1 and ERS1, the results indicating that these receptors played the major role in ethylene signaling in Arabidopsis. The ethylene receptor ETR2 was demonstrated to be targeted for degradation following binding of the ligand ethylene. The ethylene receptor ETR1 was found to physically interact with the other ethylene receptors, with the data supporting a model in which the ethylene receptors exist in plants as clusters and that interactions among receptors contribute to ethylene signal output.

Science objectives for 2009-2010:

- Further characterization of the role for histidine kinase activity of the receptors in modulating signal output. These studies will take advantage of receptor null backgrounds into which various mutant versions of the receptors are expressed.
- Develop methods to assay the effect of ethylene upon receptor kinase activity. For this purpose we are working with both in planta systems as well as heterologous systems for receptor expression.
- Characterize the role of the *Ethylene Feedback Mediator (EFM)* family of genes in modulation of signal output from the receptors. In particular we will determine if the EFM proteins are capable of physical interaction with the receptors.

References to work supported by this project 2007-2009:

1. Chen, Y.-F., Shakeel, S.N., Bowers, J., Zhao-X.-C., Etheridge, N., and Schaller, G.E. (2007) Ligand-induced degradation of the ethylene receptor ETR2 through a proteasome-dependent pathway in Arabidopsis. *J. Biol. Chem.* 282: 24752 – 24758
2. Qu, X., Hall, B.P., Gao, Z., and Schaller, G.E. (2007) A Strong Constitutive Ethylene-Response Phenotype Conferred on Arabidopsis Plants Containing Null Mutations in the Ethylene Receptors *ETR1* and *ERS1*. *BMC Plant Biol.* 7:3.
3. Hall, B.P., Shakeel, S.N., and Schaller, G.E. (2007) Ethylene receptors: ethylene perception and signal transduction. *J. Plant Growth Reg.* 26:118-130
4. Schaller, G. E. and Binder, B.M. (2007) Biochemical characterization of plant ethylene receptors following transgenic expression in yeast. *Methods Enzymol.* 422: 270-287.
5. Gao, Z., Wen, C.-K., Binder, B.M., Chen, Y.-F., Chang, J., Chiang, Y.-H., Kerris III, R.J., Chang, C., and Schaller, G.E. (2008) Heteromeric interactions among ethylene receptors mediate signaling in Arabidopsis. *J. Biol. Chem.* 283:23081-23810.

6. Schaller, G. E., Kieber, J. J., and Shiu, Shin-Han (2008) Two-component signaling elements and histidyl-aspartyl phosphorelays (version 2.0). in *The Arabidopsis Book* (Somerville, C., and Meyerowitz, E., eds.) American Society of Plant Biologists. Rockville, MD, doi: 10.1199/tab.0112, <http://www.aspb.org/publications/arabidopsis/>.
7. Gao, Z., and Schaller, G.E. (2009) The role of receptor interactions in regulating ethylene signal transduction. *Plant Signaling and Behavior*. In press.

Geometric and Electronic Structure of the Mn₄Ca Cluster in Photosystem II

Vittal K. Yachandra, Principal Investigator

Junko Yano, Kenneth Sauer, Co-PIs

Jan Kern, Yulia Pushkar, Postdocs

Physical Biosciences Division, Lawrence Berkeley National Laboratory, Berkeley, CA 94720

Email: vkyachandra@lbl.gov Web: <http://www.lbl.gov/vkyachan/index.html>

Overall research goals: The objective of this proposal is to study the structure of the Mn₄Ca complex of Photosystem II and understand the mechanism by which water is oxidized to dioxygen at the metal site. We propose to develop and utilize new methodologies of X-ray spectroscopy in our investigations of photosynthetic water oxidation. The specific questions that are the focus of the new methods being developed are: 1) What is the geometric and electronic structure of the tetranuclear manganese cluster of the photosynthetic oxygen-evolving complex (OEC)? 2) What are the structural and electronic state changes as the OEC traverses the enzymatic cycle driven by four successive photons?

Significant achievements 2007-2009: 1) We developed the method of range-extended EXAFS, for improving the resolution of the method to ~ 0.1 Å, using an multi-crystal array X-ray spectrometer. We applied the new methodology to oriented PS II membrane samples in the S₁ and S₂ state. We were able to determine that there are three Mn-Mn vectors; two at ~ 2.7 Å and one at ~ 2.8 Å and their orientations. Additionally, for the first time we were able to resolve the Fourier peak at ~ 3.3 Å into one Mn-Mn vector at 3.3 Å and two Mn-Ca vectors at 3.4 Å, that are aligned at different angles to the membrane normal. This result gives clear criteria for selecting and refining possible structures from the repertoire of proposed models.

2) Our early work with Mn EXAFS of PS II samples containing Ca or Sr, and the more recent studies using Ca and Sr EXAFS have unequivocally established that the catalytic complex is a heteronuclear Mn₄Ca cluster. These results have been validated by the X-ray diffraction studies that have identified Ca as a part of the Mn cluster by the use of Ca and Sr anomalous diffraction studies. Because of the greater accessibility of Sr-EXAFS relative to that of Ca, we carried out Sr-EXAFS on Sr-substituted PS II by collaborating with Dr. Alain Boussac (CEN-Saclay, France) who has succeeded in preparing PS II samples from *T. elongatus* grown in a medium that is Sr-sufficient, but Ca-deficient. There are many advantages of biosynthetic preparation over Ca/Sr exchange by biochemical procedures. These PS II preparations exhibit excellent activity in photosynthetic oxygen evolution, and they can be made with little adventitious Sr. We have carried out Sr EXAFS studies in the S₁, S₂, S₃ and S₀ states and the results unequivocally show that the Sr(Ca) atom is proximal to Mn in all the S-states, confirming the presence of a heteronuclear Mn₄Ca complex (Fig. 1). More interestingly, the results show significant changes in the Sr(Ca)-Mn vectors as the system is advanced to the higher S-states, showing that Sr(Ca) is not just a spectator atom involved in providing a framework but is actively involved in the mechanism of photosynthetic water oxidation, representing a rare example of a catalytically active Ca(Sr) cofactor. The results show that the Ca/Sr is linked to Mn via an oxo-bridge and is consistent with what we have observed in Mn-Ca/Sr inorganic model complexes.

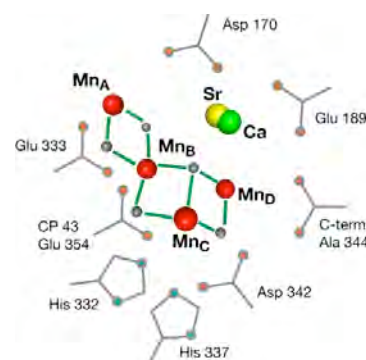

Fig. 1. Ca atom (in green) and Sr atom (in yellow) were placed into the structural model derived from a polarized Mn EXAFS in the S₁ state. Only small changes in the Sr atom position are required, compared to the position of the Ca determined from polarized XAFS studies of PS II crystals, to satisfy the Sr EXAFS data from Sr-PS II.

3) Polarized XAFS studies of Mn(V) complexes have been used to understand the electronic properties of high-valent Mn complexes, that have been as proposed as intermediate states in the photosynthetic oxidation of water, and in the formation of the O-O bond.

Science objectives for 2009-2010:

- We are making good progress with the polarized XAS studies of single crystals of PS II in the S₂ state. *In situ* illumination of the crystals at the X-ray synchrotron source (SSRL) promises to make a significant difference in the quality of the data, as it will preclude any temperature cycling of the crystals that is necessary if the crystals are illuminated at home.
- We will study the effects of mutations of direct potential ligands (D1-polypeptide His332Glu and CP43-polypeptide Glu354Gln mutations) to the Mn₄Ca cluster using Mn XAS. The preliminary results show that each mutation has an unique effect on the Mn₄Ca cluster, suggesting that the ligand environment is finely tuned to work with the metal cluster.
- RIXS and Kβ X-ray emission spectroscopy will be applied to study the electronic structure of the Mn₄Ca cluster and for detecting the bridging oxo ligands of the cluster in all the intermediate S-states.

References to work supported by this project 2007-2009:

Papers

1. Pushkar, Y., Long, X., Glatzel, G., Brudvig, G. W., Dismukes, G. C., Collins, T. J., Yachandra, V. K., Yano, J., Bergmann, U. (2009) Direct Detection of Oxygen Ligation to the Mn₄Ca Cluster of Photosystem II by X-ray Emission Spectroscopy. (submitted).
2. Smolentsev, S., Soldatov, A. V., Messinger, J., Merz, K., Weyhermuller, T., Bergmann, U., Pushkar, Y., Yano, J., Yachandra, V. K., Glatzel, P. (2009) X-ray Emission Spectroscopy to Study Ligand Valence Orbitals in Mn Coordination Complexes. *J. Am. Chem. Soc.* **131**, 12451-12457.
3. Pushkar, Y., Yano, J., Sauer, K. Boussac, A., Yachandra, V. K. (2008) Structural Changes in the Mn₄Ca Cluster and the Mechanism of Photosynthetic Water Splitting. *Proc. Natl. Acad. Sci. U. S. A.* **105**, 1879-1884.
4. Mishra, A., Pushkar, Y., Yano, J., Yachandra, V. K., Wernsdorfer, W., Abboud, K. A., Christou, G. (2008) Single-Molecule Magnetism Properties of the First Strontium-Manganese Cluster [SrMn₁₄O₁₁(OMe)₃(O₂CPh)₁₈(MeCN)₂]. *Inorg. Chem.* **47**, 1940-1948.
5. Zein, S., Kulik, L. V., Yano, J., Kern, J., Pushkar, Y., Zouni, A., Yachandra, V. K., Lubitz, W., Neese, F., Messinger, J. (2008) Focusing the View on Nature's Water-Splitting Catalyst. *Phil. Trans. R. Soc. London B.* **363**, 1167-1177.
6. Yano, J., Robblee, J. H., Pushkar, Y., Marcus, M. A., Bendix, J., Workman, J. M., Collins, T. J., Solomon, E. I., George, S. D., Yachandra, V. K. (2007) Polarized X-ray Absorption Spectroscopy of Single-Crystal Mn(V) Complexes Relevant to the Oxygen Evolving Complex of Photosystem II. *J. Am. Chem. Soc.* **129**, 12989-13000.
7. Pushkar, Y., Yano, J., Glatzel, P., Messinger, J., Lewis, A., Sauer, K., Bergmann, U., Yachandra, V. K. (2007) Structure and Orientation of the Mn₄Ca Cluster in Photosystem II Membranes Determined by Polarized Range-Extended X-ray Absorption Spectroscopy. *J. Biol. Chem.* **282**, 7198-7208.
8. Mishra, A., Yano, J., Pushkar, Y., Yachandra, V. K., Abboud, K. A., Christou, G. (2007) Heteronuclear MnCa/Sr Model Complexes, and Ca/Sr EXAFS Spectral Comparisons with the Oxygen-Evolving Complex of Photosystem II. *Chem. Comm.* 1538-1540.

Reviews

Six reviews in the following Journals: 1) 'Making Oxygen' Forum Issue of *Inorg. Chem.*, (2008), 2) *Coord. Chem. Revs.*, (2008), 3) *Phil. Trans. R. Soc. London B.*, (2008), 4) *J. Japan. Soc. Synchrotron Rad. Res.*, (2007), and 5) two in *Photosynth. Res.* (2007, 2009).

Novel Mechanisms of Microbial CO₂ Fixation

John W. Peters, Principal Investigator

Department of Chemistry and Biochemistry, Montana State University, Bozeman, MT 59717

Email: john.peters@chemistry.montana.edu; Web: <http://www.chemistry.montana.edu/john.peters/>

Overall research goals: The research objectives utilize a mainly structure based approach to gain insight into the mechanism of novel carboxylating enzymes involved in microbial alkene and ketone metabolism. The two enzymes of interest in the study include a novel disulfide

oxidoreductase involved in propylene metabolism termed 2-ketopropyl coenzyme M oxidoreductase / carboxylase (2-KPCC) and an ATP utilizing enzyme involved in the metabolism of isopropanol or acetone termed acetone carboxylase (AC). The project has focused on the following specific aims (1) capture and structural characterization of mechanistically relevant ligands at the active site of 2-KPCC; (2) high resolution structural characterization of 2-KPCC; and (3) determining the structure of acetone carboxylase. In our work on 2-KPCC, we have been very successful at using our detailed knowledge of the biochemistry of these interesting enzymes to generate crystallization conditions that allow us to capture and structurally characterize the enzyme in multiple states along the pathway of catalysis. These studies have been very insightful in terms of the mechanism. In our work on AC, we have been able to solve the initial structure and are currently building and refining an initial model.

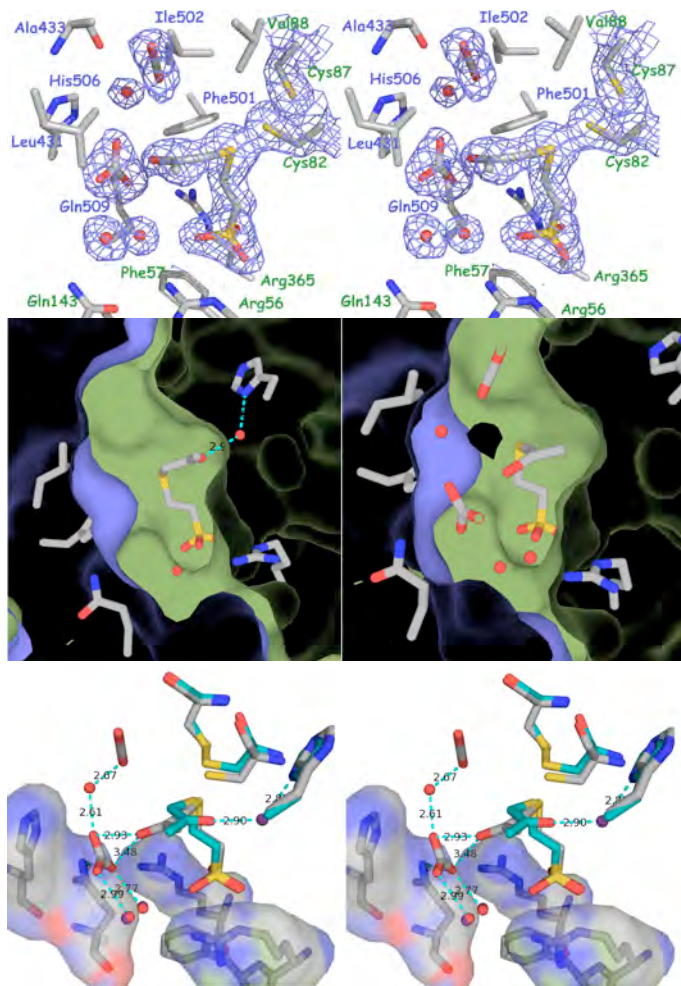

Figure 1: Top- Stereo view of the active site of 2-KPCC showing electron density around 2-ketopropyl coenzyme M, bicarbonate and carbon dioxide and water molecules, contoured to 1σ . Residues contributed by the two subunits are labeled in different colors. Center (Left)-Surface rendering of the 2-ketopropyl coenzyme M bound structure of 2-KPCC. The dark areas of the two subunits (blue and green) represent the space inside the protein, the bright area represents the substrate binding pocket. Positions of the substrate binding residues, His137, His137 bound water molecule, the water molecule at the anion binding site and residues corresponding to the catalytic dyad are shown. Center (Right): Surface rendering of the bicarbonate bound crystal structure of 2-KPCC. Dark and light areas represent the same features as the figure on left. Positions of the bicarbonate molecule with surrounding waters, the CO₂ molecule and the product of the reverse reaction, 2-ketopropyl coenzyme M are shown along with positions of the relevant residues. Bottom: A superimposition of the bicarbonate bound structure (gray) on the substrate bound structure (cyan). The two anion binding sites are shown as surface rendering colored according to nature of amino acids, blue for basic and red for acidic moieties. All figures were generated with PyMOL.

Significant achievements 2007-2009:

- The structure of 2-KPCC has been determined with bound CO₂ at the active site providing significant insights into the how CO₂ attacks the carbanion intermediate.
- Structures of 2-KPCC in the presence of inhibitors such as oxopropylphosphonic acid and various oxo substituted carboxylic acids have provided insights into substrate binding and product release
- High resolution (1.5 Å) structure of 2-KPCC in the presence of bound substrate and NADP⁺/NADPH providing the basis for: 1) a closer look the key details of the enzyme related to mechanism; 2) a detailed description of nucleotide interactions; and 3) comparison with other key enzymes in the disulfide oxidoreductase family.
- Heavy atom derivatives of AC have been generated that have allowed the determination of reliable enough phases to generate interpretable electron density maps and begin to construct an initial structural model of the enzyme.

Science objectives for 2009-2010:

- Completing the AC model building and refinement
- Interpretation of the AC structural model and the development of working hypotheses for the catalytic mechanism
- Optimizing the conditions for the cocrystallization of AC substrates and inhibitors
- Identification of additional model novel carboxylating systems for study

References to work supported by this project 2007-2009:

1. A. M. Krishnakumar, D. Silwa, J. A. Endrizzi, E. S. Boyd, S. A. Ensign, and J. W. Peters “Getting a handle on the role of coenzyme M in alkene metabolism” *Microbiol. Mol. Biol. Rev.* **72**: 445-46 (2008)
2. A. S. Pandey, B. P. Nocek, J. A. Endrizzi, S. A. Ensign, and J. W. Peters “CO₂ captured at the active site of 2-ketopropyl coenzyme M oxidoreductase / carboxylase” *FEBS Lett. submitted* (2009).
3. A. S. Pandey, E. S. Boyd, S. A. Ensign, and J. W. Peters “2-ketopropyl-coenzyme M oxidoreductase / carboxylase, a novel disulfide oxidoreductase” *In preperation*

Regulation of H₂ and CO₂ Metabolism: Factors Involved in Partitioning of Photosynthetic Reductant in Green Algae

Maria L. Ghirardi (**Primary Contact**) and Narayana Murthy (**Research Associate**)
National Renewable Energy Laboratory, 1617 Cole Blvd., Golden CO 80401
303-386-6312 (phone), 303-384-6150 (Fax); e-mail: maria_ghirardi@nrel.gov

Subcontractors:

Matthew Posewitz, Colorado School of Mines, Golden CO, 80401
Patrice Hamel, Ohio State University, Columbus OH, 43210

Overall Research objectives

The objective of this research is to continue to develop fundamental understanding about the regulation of partitioning of photosynthetic reductants (at the level of ferredoxin) between the H₂-production and the CO₂-fixation pathways. Our approaches are: (a) to screen random mutagenesis libraries of the green alga *C. reinhardtii* for mutants with attenuated H₂ photoproduction activity. Our previous analysis of mutant libraries has led to the discovery of maturation proteins that are required for the proper assembly of hydrogenases, and to the discovery of the STA7 isoamylase and of the putative 3-hydroxybutyrate dehydrogenase genes, reflecting the importance of starch and lipid metabolic pathways for H₂ production; (b) to determine whether the recently identified FixL homologs in *C. reinhardtii* play a role in this organism's O₂-sensing mechanism and may mediate components of the anoxic regulatory response that lead to hydrogenase expression; (c) to identify the promoter regions and transcriptional elements activating the expression of hydrogenases in *C. reinhardtii*.

FY09 Achievements

- This year, our collaborator, Dr. Posewitz standardized the deposition procedure used to obtain the chemochromic sensors, and we have been able to reliably generate more stable films. Using these high-quality sensors, we identified at least five new mutants from random insertional mutagenesis libraries of *C. reinhardtii* displaying altered hydrogen production. One of them was caused by interruption of the *HYDG* gene, encoding a hydrogenase assembly protein that, together with the previously found HYDEF is minimally necessary for expression of active algal hydrogenase in *E. coli*. The new mutagenesis libraries were provided by our collaborator, Dr. Patrice Hamel, and they incorporate the bleomycin resistance gene as a marker. Characterizing of these mutants will allow us to understand what other proteins factors may be required for optimal hydrogenase activity.
- To investigate the potential role of the FixL homologs in O₂-sensing in *C. reinhardtii*, we successfully purified two recombinant polypeptides containing the heme-binding domains from the *C. reinhardtii* FIXL1 and FIXL5 proteins. We are currently testing their ligand-binding characteristics to determine whether they are able to coordinate O₂ and/or CO. These data will be correlated with the transcriptional level of the respective FixL homologs upon exposure of algal cultures to O₂ and other gases.

- Finally, we have generated *C. reinhardtii* transformants with *HYDA1* and *HYDA2* truncated promoters. These transformants will be characterized to identify precise regulatory elements controlling hydrogenase gene expression.

References to work supported by this project, 2007-2009.

1. Seibert, M., P. King, M.C. Posewitz, A. Melis, and M.L. Ghirardi. 2008. "Photosynthetic Water-Splitting for Hydrogen Production," in Bioenergy (J. Wall, C. Harwood, and A. Demain, Eds.) ASM Press, Washington DC, pp. 273-291.
2. Posewitz, M.C., A. Dubini, J.E. Meuser, M. Seibert and M.L. Ghirardi. 2008. "Hydrogenases, hydrogen production and anoxia" in The Chlamydomonas Sourcebook, Vol 2: Organellar and Metabolic Processes (D. Stern, ed.) Elsevier Scientific 217-255.
3. Ghirardi, M.L., A. Dubini, J. Yu and P.C. Maness. 2009. "Photobiological hydrogen-producing systems". Chem. Soc. Rev. 38, 52-61.
4. Meuser, J.E., G. Ananyev, L.E. Wittig, S. Kosourov, M.L. Ghirardi, M. Seibert, G.C. Dismukes and M.C. Posewitz. 2009. "Phenotypic Diversity of Hydrogen Production in Chlorophycean Algae Reflects Distinct Anaerobic Metabolisms". J. Biotechnol. 142, 21-30.
5. Maness, P.C., J. Yu, C. Eckert and M.L. Ghirardi. 2009. "Photobiological hydrogen production – prospects and challenges" Microbe 4, 275-280.

Mechanism of Solar Energy Storage by Chlorosome Antennas of Green Photosynthetic Bacteria

Robert E. Blankenship, Principal Investigator

Departments of Biology and Chemistry, Washington University in St. Louis

Campus Box 1137, One Brookings Drive, St. Louis, MO 63130

Email: blankenship@wustl.edu; Web: http://www.chemistry.wustl.edu/robert_blankenship
<http://biology4.wustl.edu/faculty/blankenship/>

Overall research goals:

This project is concerned with the structure and function of the antenna complexes found in green photosynthetic bacteria, which include chlorosomes, the Fenna-Matthews-Olson (FMO) antenna protein and integral-membrane antenna complexes. All of these complexes are involved in the light-energy collection process in these organisms, which are adapted for life in very low light intensities.

Chlorosomes are ellipsoidal structures attached to the cytoplasmic side of the inner cell membrane. These antenna complexes provide a very large absorption cross section for light capture. Evidence is overwhelming that the chlorosome represents a very different type of antenna from that found in any other photosynthetic system yet studied. It is now clear that chlorosomes do not contain traditional pigment-proteins, in which the pigments bind to specific sites on proteins. Instead, the chlorosome pigments are organized *in vivo* into pigment oligomers in which direct pigment-pigment interactions are of dominant importance. Our group has used a multidisciplinary approach to investigate this unique system, as well as the complexes that they directly interact with. These systems are of interest from both a basic science perspective of what is the structure of this unique class of photosynthetic antennas and how they work so efficiently, as well as more applied aspects in which the principles of self organization and extraordinary pigment properties that characterize these systems are used in a bio-mimetic approach to devise artificial light-energy capture systems. Our work has included using model systems, both steady-state and ultrafast spectroscopy, molecular biology, protein chemistry and X-ray crystallography.

Significant achievements 2007-2009:

We have had excellent progress in several areas. Numbers cited refer to DOE-sponsored publications that are listed below. Our group has continued our very productive collaboration with the group of Prof. Graham Fleming from UC Berkeley on the use of 2-dimensional spectroscopy of the FMO protein (4,6,7). This technique has revealed new energy transfer pathways and quantum coherence effects, the first time that such effects have ever been observed in any biological system. We have recently utilized advanced mass spectroscopic methods and chemical labeling techniques to establish the *in vivo* orientation of the FMO protein on the photosynthetic membrane (9) (Fig. 1). This work has been done in collaboration with Prof. Michael Gross at Washington University. In addition to spectral studies on FMO, we have collaborated with Dr. Dale Tronrud from the Univ. of Oregon on a new ultrahigh resolution X-ray structure of the FMO protein at 1.3 Å resolution (8). This study reveals that a previously undetected eighth pigment is present in substoichiometric quantities and that Mg in this pigment is hexacoordinate. All other protein-bound chlorophylls in both antenna and reaction center complexes exhibit pentacoordinate Mg ligation, so this is an important new finding. We have recently collaborated with Prof. Pratim Biswas at Washington Univ. to construct a bio-hybrid device that incorporates chlorosome complexes on a TiO₂ substrate (12) (Fig. 2). This device maintains the native properties of the chlorosome and transfers excitation that leads to electrical current. Further characterization is underway. Other work has involved antenna studies on a range of organisms and complexes (1-3, 5, 10, 11, 13).

Science objectives for 2009-2010:

Work for the coming year will involve all the subsystems. A new direction is the use of intact mass spectrometry for further characterization of the FMO protein. This gives a mass measurement for the complete complex, including all protein subunits, pigments and bound water. Additional work will involve identification of the binding site for the FMO protein with the CsmA baseplate protein from the chlorosome.

We will focus on characterization of the newly discovered pigment in the FMO using various types of spectroscopy. We have also begun work on the highly divergent FMO protein from the newly discovered phylum of phototrophs, Chloroacidobacteria, in collaboration with Prof. Don Bryant from Penn. State Univ.

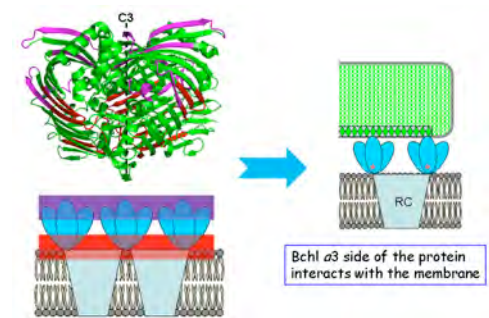

Fig. 1 Mass-spectrometric mapping of the FMO protein onto the photosynthetic membrane (9).

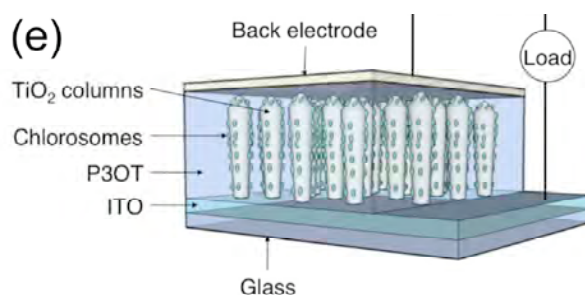

Fig. 2 Bio-hybrid device incorporating chlorosomes on TiO_2 columns (12).

References to work supported by this project 2007-2009:

1. Olson TL, van de Meene AML, Francis JN, Pierson BK and Blankenship RE (2007) Pigment Analysis of “*Candidatus Chlorothrix halophila*”, a Green Filamentous Anoxygenic Phototrophic Bacterium. *J. Bacteriology* **189**: 4187-4195.
2. van de Meene AML, Olson TL, Collins AM and Blankenship RE (2007) Initial Characterization of the Photosynthetic Apparatus of “*Candidatus Chlorothrix halophila*”: A Filamentous, Anoxygenic Photoautotroph. *J. Bacteriology* **189**: 4196-4203.
3. Hohmann-Marriott M and Blankenship RE (2007) Variable fluorescence in green sulfur bacteria. *Biochim. Biophys. Acta* **1767**: 106-113.
4. Engel GS, Calhoun TR, Read EL, Ahn TK, Mancal T, Cheng Y-C, Blankenship RE and Fleming GR (2007) Evidence for wavelike energy transfer through quantum coherence in photosynthetic systems. *Nature* **446**: 782-786.
5. Hohmann-Marriott M and Blankenship RE, (2007) Hypothesis on chlorosome biogenesis in green photosynthetic bacteria. *FEBS Lett.* **581**: 800-803.
6. Read EL, Engel GS, Calhoun TR, Mancal T, Ahn TK, Blankenship RE and Fleming GR (2007) Cross-Peak Specific Two Dimensional Electronic Spectroscopy. *Proc. Nat'l. Acad. Sci. USA* **104**: 14203-14208.
7. Read EL, Schlau-Cohen GS, Engel GS, Wen J, Blankenship RE, Fleming GR (2008) Visualization of Excitonic Structure in the Fenna-Matthews-Olson Photosynthetic Complex by Polarization-Dependent Two-Dimensional Electronic Spectroscopy. *Biophysical Journal* **95**: 847-856.
8. Tronrud DE, Wen J, Gay L, and Blankenship RE (2009) The structural basis for the difference in absorbance spectra for the FMO antenna protein from various green sulfur bacteria. *Photosynthesis Research* **100**: 79-87.
9. Wen J, Zhao H, Gross ML and Blankenship RE (2009) Surface Mapping of the FMO Antenna Protein on the Native Membrane from *Chlorobium tepidum* by a Combination of Chemical Labeling and Mass Spectrometry. *Proc. Nat'l. Acad. Sci. USA* **106**: 6134-6139.
10. Collins AM, Xin Y, and Blankenship RE (2009) Pigment Organization in the Photosynthetic Apparatus of *Roseiflexus castenholzii*. *Biochim Biophys Acta* **1787**: 1050-1056.
11. Tang K-H, Wen J, Li X and Blankenship RE (2009) The role of the AcsF protein in *Chloroflexus aurantiacus*. *J. Bacteriology* **191**: 3580-3587.
12. Modesto-Lopez LB, Thimsen E, Collins AM, Blankenship RE, and Biswas P (2009) Electrospray-assisted characterization and deposition of chlorosomes to fabricate a light-harvesting nano-bio device. Accepted in *Energy & Environmental Science* pending minor revisions.
13. Psencik J, Collins AM, Liljeroos L, Torkkeli M, Laurinmaki P, Ansink HM, Ikonen TP, Serimaa RE, Blankenship RE, Tuma R, Butcher SJ (2009) Structure of the chlorosomes from green filamentous bacterium *Chloroflexus aurantiacus*. *J. Bacteriology*, In Press.
14. Moulisová V, Luer L, Hoseinkhani S, Brotosudarmo THP, Collins AM, Lanzani G, Blankenship RE, Cogdell RJ (2009) Low light adaptation: Energy transfer processes in different types of light harvesting complexes from *Rhodospseudomonas palustris*. Submitted.

Proteomic Analysis of the Developing Intracytoplasmic Membrane During Chromatic Adaptation in *Rhodobacter sphaeroides*

Robert A. Niederman, Principal Investigator

Kamil Woronowicz, Raoul N. Frese, Senior Research Associates

Department of Molecular Biology and Biochemistry, Rutgers University, Piscataway, NJ 08854

E-Mail: rniederm@rci.rutgers.edu Web: <http://lifesci.rutgers.edu/~molbiosci/faculty/niederman.html>

Overall research goals: The objective of this project is to obtain an improved understanding of mechanisms involved in the assembly of energy transducing membranes. Proteomic approaches are focusing upon proteins temporally expressed during ICM development that interact with both complex-specific and general membrane assembly factors in the site-specific assembly of functional photosynthetic units. The accomplished goals include: (1) establishing a protocol for ICM assembly studies during chromatic adaptation to reduced light intensity; (2) clear native electrophoresis (CNE) procedures for separating developing pigment-protein complexes; (3) proteomic analysis of the isolated pigment-protein complexes.

Significant achievements 2008-2009: During chromatic adaptation in cells shifted from high ($1,100 \text{ w/m}^2$) to low (100 w/m^2) light intensity, the molar ratio of the peripheral light harvesting complex (LH2)/core (LH1) complex was increased by >6-fold over 24-h. Membrane growth initiation sites, isolated as an upper pigmented band (UPB) by rate-zone sedimentation of cell-free extracts in sucrose density gradients, showed only low levels of LH2 (LH2/LH1 molar ratio = 0.14) at 0-h. In contrast, ~2-fold higher LH2/LH1 levels were maintained in the main pigmented fraction (chromatophores), arising from the mature ICM, indicating that the putative CM invagination sites isolated in the UPB act as hotspots for initial assembly of LH1-RC cores. These results demonstrate that chromatic adaptation could be successfully employed for examining the differential biosynthesis of photosynthetic complexes.

Subjecting the isolated membrane fractions to CNE gave rise to four distinct bands (Figure 1): a top band containing reaction center (RC)-LH1 core complexes; a bottom band containing LH2; and two bands of intermediate migration containing both core and LH2 complexes which may represent *in vivo* associations that exist in the membrane. The accelerated synthesis of LH2 as a function of adaptation to low light intensity is also reflected in the intensity of the chromatophore gel bands (panels A, B) with a 16-fold rise in LH2 compared to the 2.2-fold rise in the RC-LH1 cores between 3 and 24 h. It was only possible to obtain a satisfactory separation of the UPB complexes with the milder digitonin solubilization conditions (panels B, C).

Proteomic analysis yielded a large array of proteins associated with the gel bands and the resulting profiles (Figure 2) could be correlated with the local organization of the ICM as revealed by atomic force microscopy (AFM). The spectral counts of F_1F_0 -ATP synthase subunits were unexpectedly high, given its low abundance in chromatophores and the inability to detect it and the more abundant bc_1 complex in AFM. The high levels of these complexes associated with LH2-enriched fractions is consistent with their localization together with LH2-only domains at the ICM vesicle edges, outside the flat ICM vesicle regions imaged by AFM. Significant levels of the preprotein translocase YidC homolog were also found, along with lesser amounts of other general membrane assembly factors such as TatA of the twin-arg translocation system, the SecY preprotein translocase subunit and the bacterial type 1 signal peptidase. One hypo-

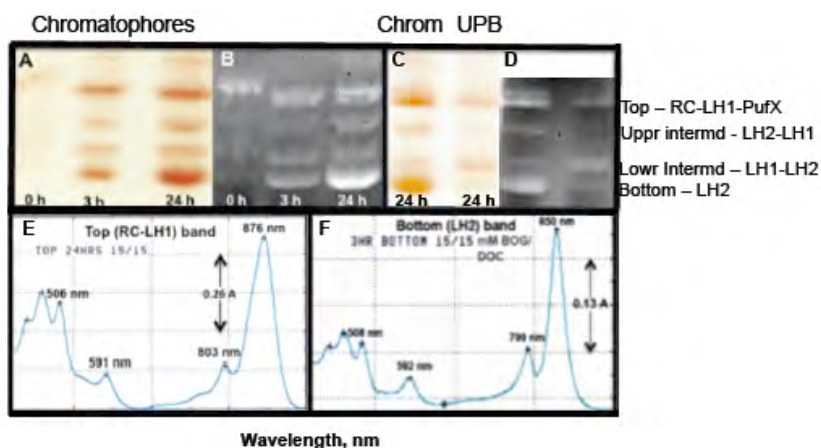

Figure 1. CNE profiles of chromatophore and UPB fractions. A,C: Scans of unstained gels. B, D: Intensity profiles of fluorescence emission from unstained gels. Chromatophores in Panel A solubilized with 1:1 n-octyl β -D-glucopyranoside/deoxycholate (BOG/DOC) detergent mixture; membrane fractions in panel C solubilized with 2 g/g digitonin/ total protein were applied to a 3-12 % gradient clear native gel. E,F: Absorption spectra of gel slices. Note high level of spectral purity of RC-LH1 complex in top band and LH2 complex in bottom band and differences in carotenoid contents, reflecting BChl:carotenoid molar ratios near 1.0 for LH1 and \sim 2.0 for LH2.

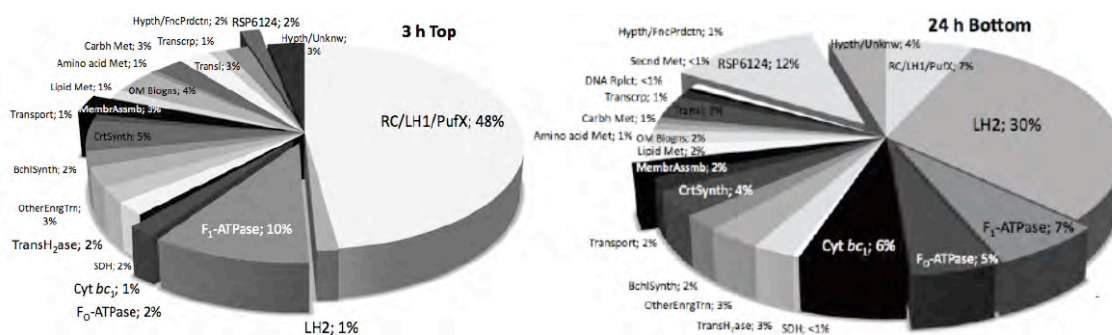

Figure 2. Spectral count distributions arising from chromatophores after in-gel trypsin digestion of gel bands that were subjected to LC-MS/MS analysis

thetical protein, RSP6124, was observed in high abundance and is associated with the LH2 band, with its appearance preceding the increase of LH2 levels during chromatic adaptation.

Scientific objectives for 2009-2010: (1) structural correlation of proteomics profiles with AFM topographs to assess local organization of developing membranes and linear dichroism measurements to follow establishment of long-range supramolecular organization; (2) functional correlates using fast repetition rate fluorescence analysis to monitor increasing antenna size, the quantum yield of the primary charge separation, and RC electron transfer turnover; (3) a more definitive analysis of complex specific and general membrane protein assembly factors that should accumulate in uncoupled cells in which pigment-protein complex assembly is disrupted.

References to work supported by this project 2008-2009:

1. J. N. Sturgis, J. D. Tucker, J. D. Olsen, C. N. Hunter, and R. A. Niederman. "Atomic Force Microscopy Studies of Native Photosynthetic Membranes." *Biochemistry* **48**:3679-3698 (2009)(Among ten most-accessed *Biochemistry* articles during April-June 2009).
2. K. Woronowicz, and R. A. Niederman. "Proteomic Analysis of the Developing Intracytoplasmic Membrane During Chromatic Adaptation in *Rhodobacter sphaeroides*." In P.C. Hallenbeck (ed.) *Recent Advances in Phototrophic Prokaryotes*. Springer. New York, NY, Submitted (2010) .

Eukaryotic initiation factor 3 (eIF3) and mRNA leader sequences as agents of translational regulation in Arabidopsis

Albrecht G. von Arnim, Principal Investigator

Byung-Hoon Kim, Postdoctoral Research Associate

Dept. of Biochemistry Cellular and Molecular Biology, The University of Tennessee, M407

Walters Life Sciences, Knoxville, TN 37996-0840

Email: vonarnim@utk.edu

Overall research goals: Protein synthesis is an energy-intensive component of cellular metabolism. Protein synthesis (translation) is also a target for regulatory controls during gene expression in response to external environmental factors and internal/developmental cues. However, questions abound concerning (i) the limitations imposed by translation on the solar-to-bioenergy conversion, (ii) the RNA sequence motifs and the molecular machinery that support translational regulation, and (iii) the corresponding cellular signaling pathways. This project approaches these questions with an emphasis on the molecular machinery, taking a genetic approach in *Arabidopsis thaliana*. Specific aims are (1) to assign molecular functions to subunits of the largest translation initiation factor, eIF3, starting with the 38kDa eIF3h subunit, using mutant analysis as well as single-gene and genome-scale assays of translational efficiency; (2) to examine the role of translational regulation in development, in particular stem cell function in the shoot apical meristem; (3) computer modeling of translation initiation as constrained by mRNA sequence motifs; (4) comparative genomic approaches to define the phylogenetic plasticity of mRNA sequence elements that drive translational control.

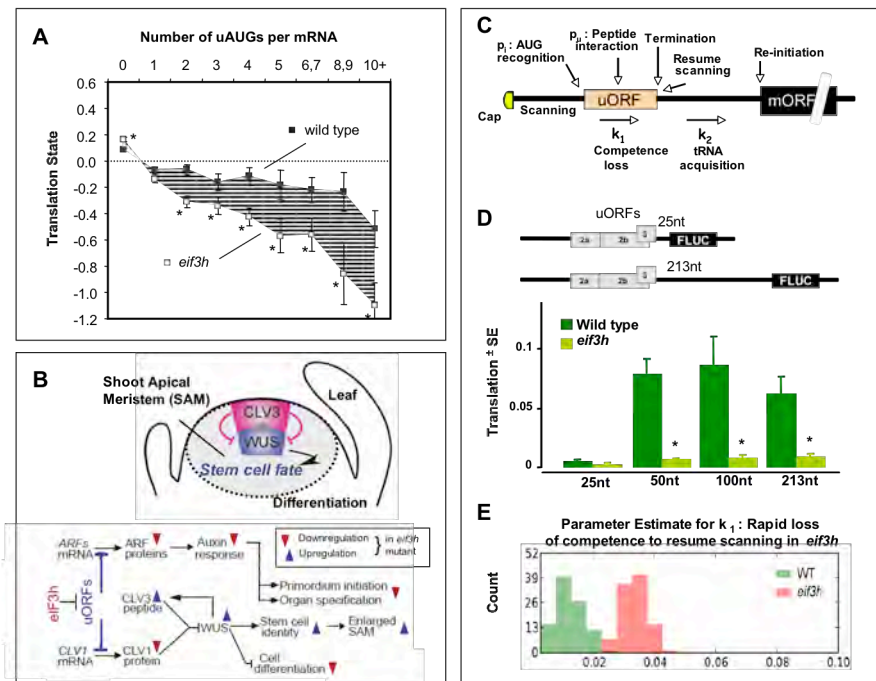

Figure 1. Roles of Arabidopsis translation factor eIF3h at the genomic, developmental, and molecular level. (A) Microarray analysis of mRNAs fractionated according to their ribosome loading shows that mRNAs with multiple upstream open reading frames (uORFs) are undertranslated in an *eif3h* mutant (Kim et al., 2007). (B) Model to summarize the role of eIF3h in shoot apical meristem development. (C) Events during translation initiation; k_1 , k_2 , p_1 , and p_2 refer to parameters implemented in our computational model. (D) In planta gene expression data supporting a role for eIF3h in translation reinitiation; FLUC=firefly luciferase gene. (E) Computational modelling suggested that wild-type eIF3h helps ribosomes retain the competence for reinitiation while translating short uORF peptides. Graph shows distribution of parameter estimates [nt⁻¹] for wild type and *eif3h* mutant.

Significant achievements 2007-2009: Using extensive mutational dissection of the 5' leader sequence of the *AtbZip11* mRNA, we assigned specific functions to the h subunit of eIF3 in the reinitiation downstream of mRNA sequence elements known as upstream open reading frames (uORFs). We constructed computational models that helped to test and refine hypotheses

concerning these molecular activities in vivo (Roy et al., submitted). We documented the utility of polysome microarrays for the genome-scale measurement of translational efficiency (Kim et al., 2007). Furthermore, we discovered that the eIF3-modulated translational control by upstream open reading frames plays a role in controlling stem cell activity and organ initiation in the control center of plant growth and development, the shoot apex (Zhou et al., submitted).

Science objectives for 2009-2010:

- ® Characterization of defects in translation for eIF3 subunits other than eIF3h. To this end we are identifying genetic lesions in most of the remaining twenty eIF3 subunit genes.
- ® Assembling a panel of translational reporter genes that allows us to probe the translational machinery for defects in many if not all events critical for successful initiation (Fig. 1C).
- ® Taking steps to measure translational efficiency by next generation sequencing of ribosome-protected fragments, in complementation of polysome microarray analysis.
- ® Elaboration of a second generation of computational model for translation initiation.
- ® Building a comparative genomics framework for phylogenetic comparison of 5' leader sequences in plant mRNAs.

References to work supported by this project 2007-2009:

1. Kim, B.H., Cai, X., Vaughn, J.N., and von Arnim, A.G. (2007). On the functions of the h subunit of eukaryotic initiation factor 3 in late stages of translation initiation. **Genome Biology** 8: R60.
2. Yahalom, A., Kim, T.H., Roy, R., Zinger, R., von Arnim, A.G., and Chamovitz, D.A. (2008). Arabidopsis eIF3e is regulated by the COP9 signalosome and impacts development and protein translation. **Plant Journal** 53: 300-311.
3. Kim, B.H., and von Arnim, A.G. (2009). FIERY1 regulates light-mediated repression of cell elongation and flowering time via its 3'(2'),5'-bisphosphate nucleotidase activity. **Plant Journal** 58:208-19. Highlighted in Faculty of 1000.
4. Zhou, F., Dunlap, J.R., and von Arnim, A.G. The translation initiation factor subunit eIF3h is involved in Arabidopsis shoot apical meristem maintenance and auxin response (submitted).
5. Roy, B., Vaughn, J.N., Kim, B.H., Zhou, F., Gilchrist, M.A., and von Arnim, A.G. The h subunit of eIF3 controls reinitiation on mRNAs harboring upstream open reading frames (submitted).

Defining the Significance of Protein Maturation in Thylakoid Development

Kentaro Inoue, Principal Investigator

Nicholas Ruppel, Postdoctoral Research Associate

Rebecca Shipman-Roston and Joshua Endow, Graduate Students

Department of Plant Sciences, University of California, One Shields Avenue, Davis, CA 95616

Email: kinoue@ucdavis.edu; Web: <http://www.plantsciences.ucdavis.edu/kinoue>

Overall research goals: Thylakoidal processing peptidase (TPP) is responsible for removal of targeting sequences from a number of thylakoid luminal proteins, such as oxygen evolving complex subunits, plastocyanin, and cytochrome f. In the model plant *Arabidopsis thaliana*, there are three TPP homologs. We previously showed that one of them named Plsp1 is necessary for proper thylakoid development and also that it is involved in maturation of one protein each in thylakoids (OE33) and in the envelope of the chloroplast (Toc75). Objectives of the research are to elucidate mechanistic details of the processes essential for the development of thylakoids by: (1) defining the significance of gene duplications giving rise to multiple TPP homologs; (2) understanding the mechanism by which Plsp1 is targeted to the two distinct internal membrane systems of chloroplasts. Biochemical and genetic tools, which we have already established and will also develop, are used to achieve these aims. The biogenesis of thylakoids, the photosynthetic compartments, is a prerequisite for efficient conversion and transduction of biological energy, and is also essential for proper plant growth and development. Achieving the aims of the research will eventually address the outstanding question regarding the origin of thylakoids. It should also advance our basic understanding of intraorganellar protein trafficking.

Significant achievements 2008-2009:

1. Discovery of the unique suborganellar localization pattern of Plsp1: Our initial genetic study suggested that Plsp1 is targeted to both the envelope and thylakoids, although the mechanism and significance of this “dual-localization” remains largely elusive. We took immunoblotting and electron microscopy immunolocalization assays to show that Plsp1 is evenly distributed in the envelope and thylakoids of developing chloroplasts in meristems, whereas it is mainly located in thylakoids of developed chloroplasts in leaf mesophyll. This localization pattern corresponded to accumulation of transcripts for Plsp1 substrates in the envelope and thylakoids. Furthermore, developing chloroplasts processed its envelope substrate Toc75 more efficiently than did developed chloroplasts. These findings help establish the rationale for the multiple suborganellar localizations of Plsp1.

2. Identification of novel Plsp1 substrates: Extensive analysis of *plsp1*-null plastids identified OE23 and plastocyanin as two Plsp1 substrates in thylakoid lumen, in addition to OE33. The plastids that lack Plsp1 accumulate vesicles of various sizes and shapes in the stroma, instead of stacked thylakoids. By immunolocalization assay under the electron microscope, we found that the unprocessed forms of OE33 in *plsp1*-null plastids associate with the peripheral area of these vesicles. These data suggest that i) Plsp1 may be the main TPP isoform; and ii) the lack of luminal protein maturation prevents stacking of thylakoid membranes.

3. Significance of protein maturation in the chloroplast envelope: One of the outstanding questions relevant to the function of Plsp1 was if the Plsp1-mediated processing of the protein translocation channel Toc75 in the envelope is required for proper thylakoid development. Knockout of the *TOC75* gene results in embryo-lethal. We established a genetic complementation system with a genomic clone, and used it to generate plants in which the endogenous Toc75 was replaced with an “un-cleavable” form that cannot be completely matured even in the presence of Plsp1. Interestingly, the resultant plants were visibly indistinguishable from wildtype under the normal growth condition. They also accumulate major thylakoid proteins in a level comparable to that in wildtype. Hence, incomplete maturation of Toc75 by itself does not seem to be sufficient to cause the seedling lethal phenotype of *plsp1*-null plants.

Science objectives for 2009-2010:

- Inducible gene knockdown systems for the three TPP homologs (Plsp1, 2, and 3) will be established and used to elucidate the functions of these proteins in *A. thaliana*. Most of necessary constructs have been prepared in binary vectors as of August 2009. We will analyze the visible phenotypes including growth, accumulation of photosynthetic proteins, and the morphology of plastids both in photosynthetic and non-photosynthetic tissues.
- We will test if Plsp2 and/or Plsp3 can complement the seedling lethal phenotype of *plsp1*-null plants. Our preliminary result suggests that Plsp2 cannot substitute for Plsp1. In addition, our detailed *in silico* sequence comparison has resulted in identification of several amino acid residues that appear to be specific to Plsp1 or Plsp2/3. We will confirm the preliminary result of the genetic complementation assay. We will also start examining structure-function relationships of TPP homologs by creating and using constructs encoding various chimeric proteins.
- One of our preliminary results indicated that Plsp1 in thylakoids appears to exist as an oligomeric form. DNA constructs encoding Plsp1 with two different tags will be introduced in *plsp1*-null plants. The first tag is Citrine, a derivative of yellow fluorescent protein. The second one is a T7 tag. If the production of the tagged proteins can complement the phenotype, we will examine their i) suborganellar localization not only in chloroplasts but also in non-photosynthetic plastids under the confocal microscope (Citrine-tagged one) and ii) complex formation by Blue-Native Page (T7-tagged one). Cross-linking assay will also be used to test any interactions of Plsp1 with other proteins. The outcomes of these experiments should allow us to visualize the localization and also to test the oligomeric formation of Plsp1.
- *In vitro* protein targeting assay system with isolated thylakoids will be established and used to test if Plsp1 utilizes any known pathway for its integration into thylakoids.

References to work supported by this project 2008-2009:

1. R. L. Shipman, and K. Inoue, "Suborganellar localization of plastidic type I signal peptidase 1 depends on chloroplast development," *FEBS Lett.* **583**: 938-942 (2009).
2. R.L. Shipman-Roston, C. Damoc, B. Phinney, and K. Inoue, "The significance of protein maturation by plastidic type I signal peptidase 1 for thylakoid development in *Arabidopsis thaliana* chloroplasts," submitted to *Plant Physiol* (June, 2009).
3. S.-C. Hsu, and K. Inoue, "Two evolutionarily conserved essential β -barrel proteins in the chloroplast outer envelope membrane", submitted to *BioSci Trends* (August, 2009).

Photoreceptor Regulation and Optimization of Energy Harvesting in Nostoc punctiforme
Submitted by the University of California Davis Campus, John Clark Lagarias, PD/PI
co-PI's John C. Meeks, R. Dave Britt, Delmar Larsen, and Thomas Huser

OVERALL OBJECTIVES. The overall objective of these studies is to characterize the biliprotein photosensors (bilin-binding GAF domains) of the model cyanobacterium *Nostoc punctiforme* ATCC 29133. In five thrust areas described below, we seek to identify all such sensors, examine how representative members of this family function, and elucidate the biological processes that they regulate. This project combines approaches ranging from ultrafast characterization of photochemical processes through biochemical analysis of signal transduction to physiological examination of photobiology. The long-term goal is to leverage this understanding to tailor *N. punctiforme* or a related oxygenic photosynthetic, nitrogen-fixing organism via synthetic biological approaches for efficient, sustainable and carbon-neutral conversion of light into chemical energy.

SIGNIFICANCE. Like plants that effectively harvest solar energy and accumulate biomass, cyanobacteria are oxygenic photosynthetic organisms. However, light energy conversion by plants requires extensive use of nitrogen fertilizers and competes for arable land with food production. By contrast, a cyanobacterium such as *N. punctiforme* can be grown in liquid culture and can fix nitrogen with concomitant hydrogen production, thereby avoiding the need to convert biomass into usable fuel. Our group project seeks to develop the knowledge base necessary for metabolic engineering of cyanobacteria for various types of light-driven chemical energy production through characterization and functional analysis of photosensory proteins.

THRUST AREA 1: LIGHT SENSING BY BILIPROTEIN PHOTORECEPTORS OF N. PUNCTIFORME (CO-PI LAGARIAS). To engineer photosensory signal transduction in *N. punctiforme*, we need to know what the sensors are, how they work, and what biological processes they regulate. This Thrust Area aims to answer the first point by undertaking a preliminary survey of all putative bilin-binding photosensory GAF domains of *N. punctiforme*. This will give a “parts list” of photosensory biliproteins in *N. punctiforme*. In addition, we will perform more detailed analysis of three initial targets chosen because of functional information, expression pattern, and/or the ability to leverage information from related systems.

THRUST AREA 2: BILIPROTEIN PHOTORECEPTORS AND PHOTOBIOLOGY OF N. PUNCTIFORME (CO-PI MEEKS). In addition to identification of biliprotein photosensors, we also need to know which biological processes those sensors normally regulate to engineer photosensory systems for energy production. This Thrust Area is focused on establishing the functional roles of a group of biliprotein photosensors chosen on the basis of expression patterns, phenotypic information, and/or the ability to leverage information from related systems. This work will ultimately be extended to other photosensors to generate a complete picture of their biological roles, thereby setting the stage for engineering light-regulation of energy production.

THRUST AREA 3: SPIN-LABEL CHARACTERIZATION OF SIGNAL TRANSDUCTION MECHANISMS IN PHOTORECEPTOR PROTEINS (CO-PI BRITT). In addition to identifying photosensors and understanding their roles in biology, we also need to gain better understanding of how they work. This Thrust Area aims to help answer that question by examining conformational changes in signaling molecules and changes in their association with other signaling proteins on a timescale of milliseconds to minutes, using electron paramagnetic resonance (EPR) spectroscopy. While the general paradigms of biological signal transduction

should apply to light perception as well as to hormone binding or other physiological cues, the detailed behavior of different signaling systems varies. It is therefore necessary to have a detailed understanding of how individual photosensory systems work for reliable, successful deployment of those systems to applications such as metabolic retooling for energy production.

THRUST AREA 4: ULTRAFAST SPECTROSCOPIC CHARACTERIZATION OF PHOTOCHEMICAL AND STRUCTURAL EVENTS IN SIGNAL TRANSDUCTION (CO-PI LARSEN). Detailed understanding of photosensory signaling mechanism involves not only biochemical events at the level of the output domain but also the much faster initial light sensing event. We seek insight into how photoexcitation of chromophore is transduced over ~ 100 Å distances to change the signaling state of the output domain. This Thrust Area aims to address these important aspects by identifying the photochemical and conformational dynamics in biliprotein photosensors and output domains occurring at a molecular level, extending from femtoseconds to milliseconds after photoexcitation. Our experimental approaches are based on ultrafast transient absorption techniques, and we are developing a novel photo-initiated transient FRET technique to examine spectrally silent conformational changes associated with activation of signaling on nanosecond to millisecond timescales.

THRUST AREA 5: SINGLE-MOLECULE AND OPTICAL SUPER-RESOLUTION IMAGING OF *N. PUNCTIFORME* PHOTSENSORY SIGNAL TRANSDUCTION (CO-PI HUSER). The spectroscopic approaches proposed in Thrust Areas 1, 3, and 4 are also *in vitro* techniques whose applicability to authentic *in vivo* signaling must be inferred. Extra information can be gained from complementary studies at the single-molecule level - both *in vitro* to characterize protein interactions over a wide range of concentrations and *in vivo* to infer the natural response of the system and compare it to *in vitro* data. The Huser lab will examine signaling by photosensory biliproteins with several single-molecule techniques to provide a valuable addition to the *in vitro* ensemble approaches proposed under other Thrust Areas. This research also allows us to examine authentic signaling complexes in living cells, providing valuable information about the efficiency of photosensory signaling.

CURRENT STATUS. Funding for this project began on 15 September 2009, hence work is just beginning. The Lagarias lab has already cloned twelve out of approximately fifty target GAF domains. Out of those twelve, five have been expressed and purified, with two exhibiting good incorporation of bilin chromophore and robust photoconversion between photoswitchable states. Four of these domains are from protein NpR6012, which is an apparent *N. punctiforme* ortholog of AnPixJ [Narikawa *et al.* (2008) *J. Mol. Biol.* **380**: 844-855]. In AnPixJ, the second of four possible photosensory GAF domains was found to be photoactive. AnPixJ and NpR6012 have an identical domain organization. Unexpectedly, we find that the fourth GAF domain of NpR6012 is photoactive and not the second (Fig. 1).

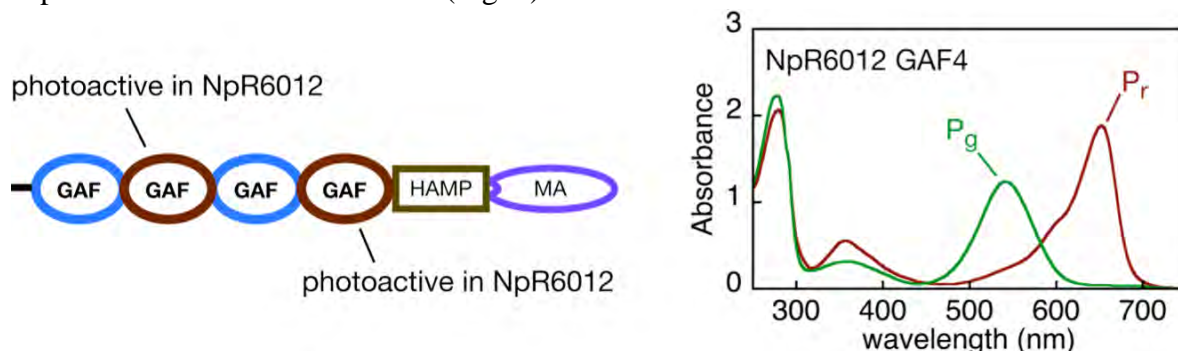

ROP9 GTPase Signaling in Auxin Regulation of Plant Growth

Zhenbiao Yang, Principal Investigator

Center for Plant Cell Biology and Department of Botany and Plant Sciences, University of California—Riverside, Riverside, CA 92521.

Email: yang@ucr.edu. Website: <http://genomics.ucr.edu/people/person-details.php?id=333>

Overall Research Goal: The research goal is to elucidate the ROP9 GTPase signaling pathway that regulates auxin-mediated growth responses by: 1) determining which of the other ROPs are functionally redundant to ROP9 in auxin signaling, 2) determining which of the auxin signaling pathways that ROP9 participates in: the TIR1 pathway or either of the two pathways respectively controlled by the putative ABP1 auxin receptor and the TMK receptor-like kinases, and 3) furthering our understanding of the ROP9 pathway by identifying ROP9-interacting partners. The TIR1-mediated auxin signaling pathway, involving auxin stabilization of TIR1 and its substrate AUX/IAA proteins and subsequent degradation of the transcriptional repressor AUX/IAA, is well established. Our finding that ROP9 is also involved in auxin signaling suggests that auxin signaling may be more complex. Our proposed research on ROP9 will generate new insights into the mechanism by which auxin regulates plant growth.

Significant Achievements 2007-2009: Two major aspects of ROP9 signaling have been investigated. First, ROP9 upstream events have been studied using ROP9 activity assays. Our experiments show that ROP9 activation by auxin is compromised in the mutant for the auxin TIR1 family receptor (*tir1afb1afb2afb3*), suggesting that the TIR1 perception of auxin is required for ROP9 activation. Second ROP9 downstream events have been explored by investigating the function of ROP effectors, RICs, in auxin mediated responses. It was previously shown that auxin induces the formation of TIR1- and COP9 signalosome-containing nuclear protein bodies in a ROP-dependent manner in tobacco. Our current studies showed that RICs are localized to these nuclear bodies and that RICs promote the formation of these nuclear bodies.

Science objectives for 2009-2010: The work in the coming year will focus on understanding the mechanism by which the TIR1 perception of auxin activates ROP9 and the significance of RIC promotion of the nuclear protein bodies. Several objectives will be accomplished:

- 1) Preliminary studies suggest that several ROP regulators are affected by the TIR1 pathway at the transcriptional level. Genetic experimental will be carried out to test the hypothesis that the transcriptional activation of RopGEFs (activators of ROPs) by TIR1 perception of auxin provides a mechanism for auxin activation of ROP9 through the TIR1 receptor.
- 2) Cell biological and genetic experiments will be carried out to determine the nature of the RIC-mediated nuclear bodies in order to gain insights into the function of these nuclear bodies. Various markers for known nuclear bodies will be used to conduct colocalization with RIC1. RIC knockout mutants will be used to confirm that the formation of these nuclear bodies are RIC-dependent and how loss of these nuclear bodies affect plant growth and development at molecular and morphological levels.

Organellar Protein Targeting and Nuclear Influence on Mitochondrial Behavior

Sally Mackenzie, Principal Investigator

N305 Beadle Center, University of Nebraska, Lincoln, NE 68588-0660

Email: smackenzie2@unl.edu

Overall research goals: The primary objectives were to investigate the regulation of protein organellar targeting in higher plants in general and of *MSH1*, a nuclear gene influencing mitochondrial genome stability and plastid development, in particular. Specific aims involved (1) Identification of cis-acting components regulating alternative translation initiation and protein dual targeting, (2) demonstration of developmentally regulated protein dual targeting, and (3) assessment of *MSH1* protein targeting behavior and influence on mitochondrial and plastid properties to alter plant development.

Significant Achievements 2007-2009: Cross-species comparative analysis and site-directed mutagenesis of UTR sequences upstream to the dual targeting protein gene *Polγ2*, encoding an organellar DNA polymerase, allowed identification of cis-acting sequences encompassing alternative non-ATG translation initiation sites (Figure 1). The alternative translation initiation activity was consistent with leaky ribosome scanning. Functional analysis, via GFP localization and *in vitro* translation initiation assays, identified multiple translation initiation products from the gene, producing both plastid and mitochondrial proteins. Plastid targeting forms of the protein predominated in photosynthetic tissues, while mitochondrially-localized forms were detected in the root. Gene features associated with alternative translation initiation were found to exist in 76 *Arabidopsis* genes, suggesting that the process might occur more generally than expected.

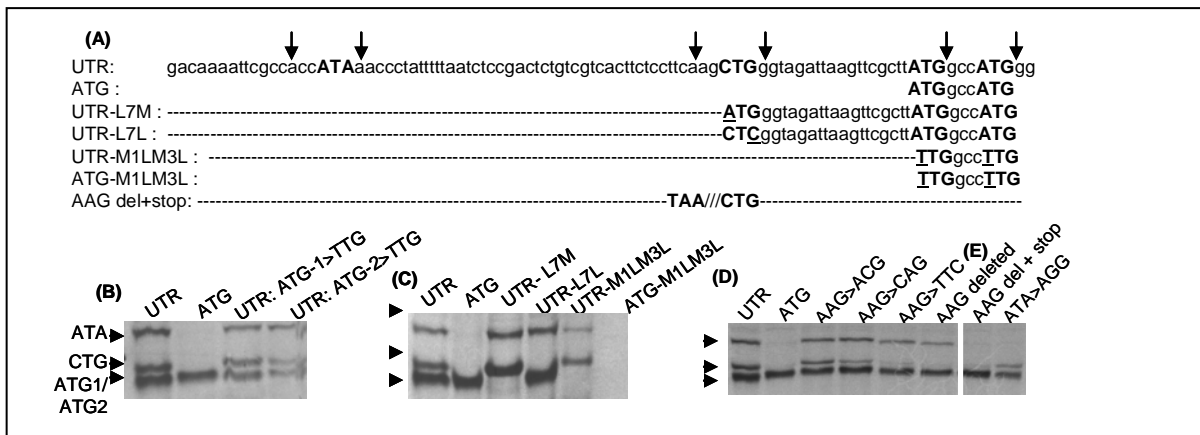

Figure 1. *In vitro* aTI activity depends on sequence context.

The *AtPolγ2* UTR region is shown in A, together with several mutations. Downward arrows indicate -3 or +4 sites in Kozak context, mutation sites are underlined, and dashes designate “same as in UTR”. (B) PAGE results show *in vitro* transcription-translation (IVTT) products when the first or the second ATG is mutated to TTG. UTR and ATG lanes serve as controls. (C) IVTT results from experiments testing both CTG and ATG sites for translation initiation activity. Mutations are defined in panel A. Substitution of ATG for CTG prevents downstream ATG initiation, consistent with Kozak predictions and ribosome scanning. (D) IVTT results show the importance of an AAG purine triplet preceding CTG for efficiency of initiation. The AAG was subjected to nucleotide substitutions and deletion (DEL). (E) Tests of initiation and in-frame translation from the upstream (-62 nt) ATA. ATA was confirmed as an initiator codon by AGG substitution. Deletion of the AAG preceding CTG was accompanied by substitution of a stop codon (TAA), demonstrating that the ATA initiated in-frame translation accounts for the larger product. Panel arrows designate products from ATA, CTG and ATG1/ATG2 translation initiation *in vitro*.

MSH1 participates in mitochondrial recombination surveillance in plants, but its mutation creates a plastid phenotype and leaf variegation. These results imply that *MSH1* is dual targeting, and we tested for evidence of alternative translation initiation. Targeting constructions were developed with GFP reporter fusions to test cellular localization of *MSH1*. *In vitro* quantitation of GFP localization in purified mitochondrial versus plastid fractions from stable transformed plants produced the following results, showing mitochondrial targeting but no plastid targeting.

MSH1 GFP fluorescence assay following organelle extraction from flowers

	Whole flower Extract		Chloroplast		Mitochondria	
	Col 0	MSH1*	Col 0	MSH1*	Col 0	MSH1*
Read 1	132	177	61	65	98	141
Read 2	135	177	62	66	99	136

Transcript profiling experiments comparing gene expression patterns in Col-0 and the *msh1* mutant demonstrate changes in nuclear gene expression leading to reduced expression of nuclear genes involved in assembly of photosystem II and other components of the photosynthetic apparatus (not shown). These data suggest that MSH1 targets mitochondria only, and its disruption gives rise to mitochondrial genome rearrangement, retrograde signaling, and altered nuclear control of plastid development.

Science objectives for 2009-2010

(1) Investigation of MSH1 influence on plastid development patterns, (2) Effect of high light intensity on ROS production in variegated *msh1* mutant materials, (3) Testing *msh1* mutant redox status and mitochondrial complex I assembly to identify linkage of mitochondrial dysfunction, nuclear gene expression changes and plastid developmental response.

References to work supported by this project 2007-2009

- Wamboldt, Y., Mohammed, S., Elowsky, C., Wittgren, C., de Paula, W. and Mackenzie S. 2009. Alternative translation initiation leads to differentially targeted protein isoforms in Arabidopsis. *Plant Cell* 21:157-67.
- Xu, Y.-Z., de Paula, W., Arrieta-Montiel, M., Mackenzie, S. Leaf green-white variegation is a mitochondrially-influenced trait in higher plants. Manuscript in preparation.

The Energy Budget of Steady-State Photosynthesis

David M. Kramer, Principle Investigator

Institute of Biological Chemistry, Washington State University, Pullman, WA 99164-6340

Tel.: (509) 335-4964 Email: dkramer@wsu.edu

Overall Research Goals

The overall goal of our work is to understand how plants capture and store solar energy to power the biochemistry of our ecosystem, while avoiding deleterious side reactions that can lead to photodamage. In our previous work, we have developed a wide array of new instruments and techniques to probe specific photosynthetic processes *in vivo*, and used these to explore the roles of proton transfer reactions in energy storage and regulation.

In the current work, we are taking advantage of these advances to target another important question: How does the chloroplast achieve the precise balancing of NADPH and ATP output needed to match the needs of the plant? Such mechanisms are essential because the production of ATP and NADPH are coupled in linear electron flow, so that imbalances in the output ratio would lead to metabolic congestion, leading to limitations in photosynthesis leading to photodamage. Addressing this issue is critical for understanding the responses of plants to their environments, the limitations to growth habitat and

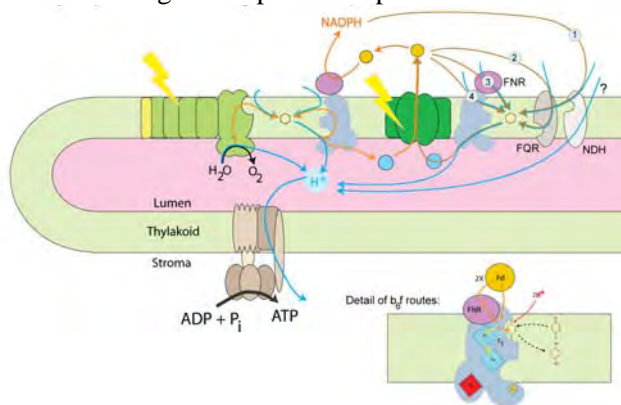

productivity, and their responses to changing climate. In addition, the ability to manipulate the photosynthesis energy balance will be critical for redirecting photosynthetic output to biofuels.

Specifically, we are addressing the role and regulation of cyclic electron flow around photosystem I (CEF1) which is thought to be important in balancing ATP/NADPH output.

CEF1 is a light-driven process that produces ATP but not NADPH. The general pathway is shown as the brown arrows in the Figure. In linear electron flow (Figure, orange arrows), electrons are extracted from water at photosystem II (light green complex) and sent into the plastoquinone

pool (beige hexagon), though the cytochrome *b₆f* complex (gray), to photosystem I (dark green) and finally to ferredoxin (Fd) and NADPH. In CEF1, plastoquinone (PQ) is not reduced by PSII. Instead, electrons from Fd or NADPH are shunted into the PQ pool, forming plastoquinol (PQH₂), via an enzyme (or group of enzymes) termed collectively as Plastoquinone Reductase (PQR). From PQH₂, electrons return to PSI via the cytochrome *b₆f* complex, resulting in proton translocation across the thylakoid membrane. There are at least four different pathways proposed for PQR, through NAD(P)H:plastoquinone reductase (NDH, “1” in the Figure), the antimycin A-sensitive ferredoxin:plastoquinone reductase (FQR, “2”), which involved the protein PGR5, through ferredoxin:NADP⁺ oxidoreductase (FNR, “3”) and through the cytochrome *b₆f* complex (“4”).

Despite decades of work, spanning the diverse fields of biochemistry, biophysics and genetics, several important aspects of CEF1 remain controversial, including the regulation, main pathway, catalytic and proton pumping capacity of key enzymes in the process.

Significant Achievements, 2007-2009

1) Using multi-stage selection of chemically-mutagenized Arabidopsis plants, we isolated a new class of mutant, *hcef* for high CEF1, which shows constitutively elevated CEF1.

2) We have identified the genetic loci of three of the four high CEF1 mutants. These occur at different points in the Benson-Calvin cycle. I will focus mainly on one of these, *hcef1*, which occurs at fructose-1,6-bisphosphatase.

3) Antisense-suppression of some other loci in the Benson-Calvin cycle did not induce the *hcef* phenotype, implying that CEF1 is induced by specific metabolic signals rather than generalized slowing of photosynthesis.

4) We demonstrated that the elevated CEF1 seen in our *hcef* mutants flows through the NDH (“1” in the Figure) rather than the proposed PGR5 (“2” in the Figure) pathway. We have preliminary evidence from knockout mutations that the proposed FNR-related pathway (“3” in the Figure) is also not involved in elevated CEF1. Preliminary data shows that knocking out the two chloroplast FNR isoforms

individually increased rather than decreased CEF1, arguing against pathway “3”. Finally, the content of the cytochrome *b₆f* complex did not change in the *hcef1* mutant, arguing that pathway “4” is also not involved.

5) We show that protein levels of NDH were dramatically upregulated in *hcef1*, indicating that the capacity for this pathway is modulated by the physiological status of the plant.

6) We provide strong evidence that CEF1 is critical for maintaining ATP levels under stress, by showing that loss of CEF1 through NDH was not compensated by activity of the malate valve, or water-water cycle.

7) Metabolite profiling data shows that *hcef1* has dramatically increased fructose 1,6-bisphosphate levels, but maintains nearly identical ATP/ADP levels. This suggests that neither ATP nor ADP is the metabolic signals that activate CEF1. Rather, these data support redox regulation, e.g. through NADPH or ferredoxin.

7) We have some very preliminary evidence that the NDH complex pumps protons, like its homolog in the mitochondrion, complex I.

Scientific Objectives for 2009-2010

We will use our set of mutants and spectroscopic tools to address (what we think is) the most critical question in this field: What controls the activity of CEF1? We are breaking this question into two sub-questions: 1) What metabolic signal(s) regulate CEF1? We will expand our investigation to *hcef2*, *hcef3* and *hcef4* mutants, together with a series of antisense mutants and transposon knockouts, each hindered in different assimilatory enzymes thus affecting metabolism in different ways. Comparison of CEF1 rate with photosynthetic metabolites and kinetics in these mutants should narrow down the range of possible regulatory metabolites. 2) What directly activates NDH? The reported rates of plastoquinone reduction by reduced NADPH and ferredoxin measured *in vitro* were only a fraction of that needed to sustain rates of CEF1 expected *in vivo*. We probed plastoquinone reduction in *hcef1* and *hcef2* and found them to also be extremely slow, even with dramatically increased *in vivo* CEF1 and NDH expression. We therefore propose that PQ reduction is activated by a factor which is lost during isolation of thylakoids. We are currently testing common or plausible activators (thioredoxin, H₂O₂, phosphorylation etc.).

Publications from supported work, 2007-2009 [1-10]

- [1] N. Baker, J. Harbinson, D.M. Kramer, (2007) Determining the limitations and regulation of photosynthetic energy transduction in leaves, **Plant Cell Environ** 30 1107-1125.
- [2] K. Takizawa, A. Kanazawa, J.A. Cruz, D.M. Kramer, (2007) In vivo thylakoid proton motive force. Quantitative non-invasive probes show the relative lumen pH-induced regulatory responses of antenna and electron transfer, **Biochim Biophys Acta** 1767 1233–1244.
- [3] J.W. Cooley, W. Nitschke, D.M. Kramer, (2008) The cytochrome *bc₁* and related *bc* complexes, the Rieske/cytochrome *b* complex as the functional core of a central electron/proton transfer complex, in: C.N. Hunter, F. Daldal, M.C. Thurnauer, J.T. Beatty (Eds.), **The Purple Photosynthetic Bacteria**, Springer, Dordrecht, The Netherlands, pp. 451-473.
- [4] J.A. Cruz, C. Emery, M. Wust, D.M. Kramer, B.M. Lange, (2008) Metabolite profiling of Calvin cycle intermediates by HPLC-MS using mixed-mode stationary phases, **Plant J** 55 1047-1060.
- [5] D. Gust, D. Kramer, A. Moore, T. Moore, W. Vermaas, (2008) Engineered and Artificial Photosynthesis: Human Ingenuity Enters the Game, **Materials Research Bulletin** 383-389.
- [6] K. Takizawa, J.A. Cruz, D.M. Kramer, (2008) Depletion of stromal inorganic phosphate induces high 'energy-dependent' antenna exciton quenching (q_E) by decreasing proton conductivity at CF_O-CF₁ ATP synthase, **Plant Cell Environ** 31 235-243.
- [7] M. Hambourger, G.F. Moore, D.M. Kramer, D. Gust, A.L. Moore, T.A. Moore, (2009) Biology and technology for the sustainable production and use of fuels, **Chemical Society Reviews** 37 25-35.
- [8] K. Kohzuma, J.A. Cruz, K. Akashi, S. Hoshiyasu, Y. Munekage, A. Yokota, D.M. Kramer, (2009) The long-term responses of the photosynthetic proton circuit to drought **Plant, Cell Environ.** 32 209–219.
- [9] Z. Li, T.K. Ahn, T.J. Avenson, J.A. Cruz, D.M. Kramer, G.R. Fleming, J.D. Keasling, K.K. Niyogi, (2009) Lutein accumulation in the absence of zeaxanthin restores nonphotochemical quenching in the *Arabidopsis thaliana npq1* mutant, **Plant Cell** In Press.
- [10] A.K. Livingston, J.A. Cruz, K. Kohzuma, A. Dhingra, D.M. Kramer, (2009) An *Arabidopsis* mutant with high cyclic electron flow around photosystem I (*hcef*) involving the NDH complex, **Plant Cell** Submitted.

Unraveling the regulation of terpenoid oil and oleoresin biosynthesis for the development of biocrude feedstocks

Bernd Markus Lange, Principal Investigator

Glenn Turner, Postdoctoral Research Associate

Siau Sie Voo, Graduate Student

Institute of Biological Chemistry, Washington State University, Pullman, WA 99164-6340

E-Mail: lange-m@wsu.edu; Web: <http://www.wsu.edu/~lange-m/index.html>

Overall Research Goals

A long-term goal of our laboratory is the establishment of quantitative conceptual models of terpenoid oil and oleoresin biosynthesis in plants, thus guiding researchers in developing superior terpenoid biofuel/biomaterial feedstocks. The expectation is that these models will be widely applicable because many characteristics of secretory gland cells (SGCs), the specialized cell types responsible for oil/oleoresin production, are conserved across diverse species. This project focuses on unraveling the factors that limit the production of biomass feedstocks in terpenoid-based biofuel/biomaterial crops. We are studying the regulation of terpenoid biosynthesis in two model plant systems that are supported by large research communities conducting genome sequencing and genomics efforts, the epithelial SGCs of Citrus fruit peel and loblolly pine resin ducts. Our research activities are designed to address critical gaps in our knowledge of how plants store energy in the form of terpenoid oils and oleoresins. This research will directly impact DoE's interests in enhanced biofuel/biomaterial production and in biomimetic strategies for assembly and storage of specialized materials.

Specific Aim 1: Establish the source(s) of precursors for the biosynthesis of monoterpenoid essential oil in Citrus fruit peel and terpenoid oleoresin in loblolly pine (*Pinus taeda*) stem.

Specific Aim 2: Evaluate the hypothesis that epithelial gland cell density and distribution are key factors determining the yield of terpenoid essential oil in Citrus secretory cavities and of oleoresin in loblolly pine resin ducts.

Specific Aim 3: Develop mathematical models simulating the regulation of oil/oleoresin biosynthesis in Citrus fruit peel and loblolly pine stems and assess the importance of feedback control.

Significant Achievements (new project!)

In the past, the scarcity and inaccessibility of specialized tissue has been a major obstacle to investigating oil/oleoresin biosynthesis in internalized SGCs. However, we have made substantial progress with isolating such specialized cells using laser microdissection (particularly with Citrus) and we are now uniquely positioned to perform experiments aimed at understanding (and eventually overcoming) biochemical limitations in biocrude production (using Citrus as a model system). The first step in isolating SGCs was the development of a tissue embedding procedure suitable for downstream RNA extraction and microarray analyses. The second step required the optimization of laser microdissection. In the third step, we focused on improving the RNA extraction protocols (Fig. 1). After RNA amplification we generated first strand cDNA, a DNA/RNA heteroduplex, and finally double strand cDNA. We then converted cDNA to cRNA and hybridized it with the GeneChip® Citrus Genome Array (Affymetrix). These analyses indicated that all genes potentially involved in essential oil biosynthesis (plastidial MEP pathway and d-limonene synthase) were expressed at high levels. We are currently in the process of adapting these methods to studying gene expression patterns in SGCs relevant to oleoresin biosynthesis in loblolly pine stems.

A. Citrus fruit peel

Figure 1. Illustration of the results obtained with laser microdissection of specific cell types.

A, Epithelial gland cells associated with secretory cavities in Citrus fruit peel.

B, Epithelial gland cells associated with resin ducts in loblolly pine stems.

Arrows indicate the position of cells that were blasted off and further processed to obtain RNA for global gene expression analyses.

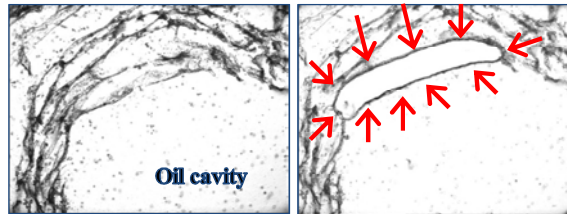

B. Loblolly pine stem

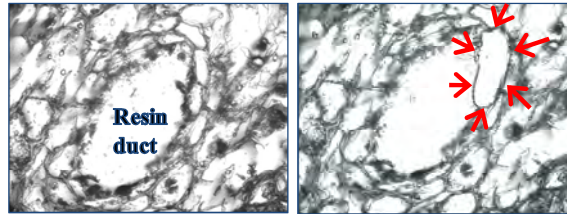

Objectives for 2009-2010

Specific Aim 1: - Determine labeling patterns in monoterpenes after feeding Citrus rind with D-[1-¹³C]glucose (establish precursor pathways for essential oil biosynthesis).
- Evaluate gene expression patterns related to oil/oleoresin biosynthesis in secretory gland cells (determine timing of oil/oleoresin synthesis and secretion).

Specific Aim 2: - Determine the density and volume of terpenoid essential oil secretory cavities in Citrus and resin ducts in loblolly pine stem (required for modeling).
Determine the yield of terpenoid essential oil in Citrus secretory cavities and oleoresin in loblolly pine ducts (required for modeling).

Specific Aim 2: - Determine global gene expression patterns in developing Citrus fruit and wounded loblolly pine stems (required for modeling).
- Estimate the volume density of the intracellular compartments relevant to terpenoid oil/oleoresin biosynthesis (required for modeling).
- Approximate dynamic changes in terpenoid oil/oleoresin biosynthetic enzyme concentrations (required for modeling).
- Generate mathematical models.

References

Rios-Estépa R., Turner G.W., Lee J.M., Croteau R.B., Lange B.M. (2008) A systems biology approach identifies biochemical mechanisms regulating monoterpenoid essential oil composition in peppermint. *Proc. Natl. Acad. Sci. USA* 105, 2818-2823.

Rios-Estépa R., Lange I., Lee J.M., Lange B.M. (2009) Mathematical modeling-guided evaluation of biochemical, developmental, environmental and genotypic determinants of essential oil composition and yield in peppermint leaves. *Plant Physiology*, submitted.

Novel Factors in the Thylakoid Lumen that Regulate Photoprotection and Repair of the Photosynthetic Apparatus in Cyanobacteria

Himadri B. Pakrasi, Principal Investigator

Department of Biology, CB 1137, Washington University, St. Louis, MO 63130

Email: Pakrasi@wustl.edu

Cyanobacteria are the largest and most diverse group of oxygenic photosynthetic prokaryotes that play major roles in biological carbon sequestration on our planet. They are also the progenitors of chloroplasts in plants and eukaryotic algae. Production of oxygen from water by the Photosystem II (PSII) pigment protein complex in the lumen of the thylakoid membrane requires a very strong oxidant, whereas the electron transfer reactions in the Photosystem I (PSI) complex on the cytoplasmic side of the same membrane generates a strong reductant. The simultaneous presence of highly oxidizing as well as reducing environments during the normal photosynthetic electron transfer reactions in cyanobacteria, inevitably leads to the production of reactive oxygen species (ROS) that can potentially damage the photosynthetic apparatus. To face this challenge, cyanobacteria have developed multiple protection and repair pathways.

The central focus of this proposed project is to determine the mechanisms of newly identified thylakoid lumen localized redox proteins in photoprotection and repair. Hydrogen peroxide (H_2O_2) is a well-known ROS and can damage many important biomolecules such as proteins and lipids. Partial oxidation of water on the donor side of PSII produces H_2O_2 , which can result in photoinhibition of the photosynthetic apparatus. We have recently determined that PrxQ-B, a lumen localized peroxiredoxin in the cyanobacterium *Synechocystis* 6803, is an important determinant in the protection of PSII against photoinhibition. A key hypothesis to be tested is that PrxQ-B is involved in the reduction of H_2O_2 generated by damaged or partially assembled PSII centers. We will also examine the potential role of DsbD-like proteins as transmembrane thiol exchangers that mediate transfer of reductants from the cytoplasmic side of the thylakoid membrane to the lumen, thus providing a redox conduit to proteins such as PrxQ-B. There are two specific aims in this proposal: (1) To determine the mechanism for photoprotection of PSII centers by PrxQ-B, and (2) To define the redox partners of PrxQ-B involved in such a protection and repair process. These studies are expected to define a novel pathway in oxygenic photosynthetic organisms to ameliorate the harmful effects of ROS.

Reference:

1. Singh, A. K., Bhattacharyya-Pakrasi, M. and Pakrasi, H. B. (2008) An Unusual Membrane-bound Dsb-like Fusion Protein Involved in Protein Disulfide Bond Formation in Oxygenic Photosynthetic Organisms. *J. Biol. Chem.*, 283: 15762-15770

Plenary Session

First-row Transition Metal-based Chromophores for Dye-Sensitized Solar Cells: Fundamental Issues and Applications

James K. McCusker
Department of Chemistry, Michigan State University
East Lansing, MI 48824 E-mail: jkm@chemistry.msu.edu

Recent attention to the dangers of climate change has spurred renewed efforts toward developing carbon-neutral sources of energy. Although there is no “silver bullet” for this impending crisis – all possible avenues must be explored – solar energy stands out as one option that has perhaps the greatest potential in terms of global scalability. At present, one of the fundamental problems associated with solar-based energy technologies is cost. In 1991, O’Regan and Grätzel published a report that heralded a new direction in the development of low-cost photovoltaics.¹ By exploiting the concept of dye-sensitization of semiconductors, these workers fabricated a solar cell based on a mesoporous film of nanocrystalline TiO₂. In conjunction with a molecular chromophore, these so-called dye-sensitized solar cells (DSSCs) have the potential to form the basis of photoconversion strategies that could make solar energy economically competitive.² It is our belief that multicomponent assemblies will ultimately be required in order to

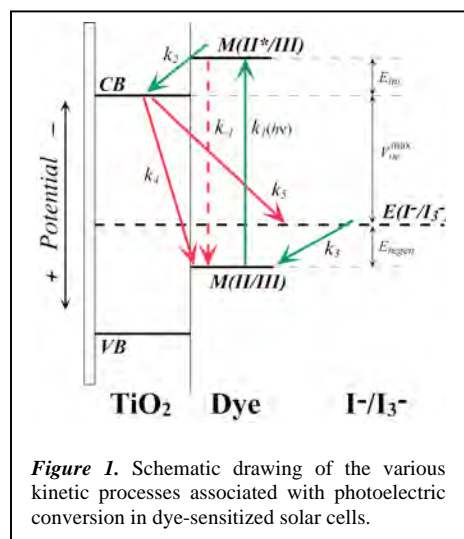

Figure 1. Schematic drawing of the various kinetic processes associated with photoelectric conversion in dye-sensitized solar cells.

achieve cost/efficiency ratios necessary for DSSCs to compete effectively with fossil fuel-based technologies: this (among other reasons) necessitates the use of extremely inexpensive materials for all components of the device. Our research program is therefore focused on the development of DSSCs with the notion of using earth-abundant materials as a cornerstone of cell design. In order to realize this important technological goal, there are a number of scientific problems that must be addressed and ultimately overcome.

Issues pertaining to the performance metrics of DSSCs can be grouped into three (ultimately interrelated) areas: (1) light management, (2) electron collection, and (3) dark reactions (Figure 1); our DOE-supported work deals primarily with the first topic and builds on our expertise in the application of ultrafast spectroscopic techniques for the study of the earliest events following photon absorption by transition metal charge-transfer complexes.³ This seminar will highlight our efforts to

develop TiO₂-based photovoltaics based on chromophores involving first-row transition metal complexes. The motivation for this line of research stems largely from the lower cost and greater scalability associated with these materials as opposed to the second- and third-row complexes currently being employed. In the course of our research, we have discovered that differences in electronic structure endemic to first-row versus isoelectronic second- or third-row complexes give rise to a fundamental change in the excited-state dynamics of such compounds that directly impacts the ability to incorporate this class of molecules into this technology. The key experimental findings establishing this paradigm will be described,⁴ along with strategies that we are currently pursuing to circumvent these problems in order to realize cheaper, more efficient photovoltaic devices.

1. a) O’Regan, B.; Grätzel, M. *Nature* **1991**, 353, 737. b) Grätzel, M. *Inorg. Chem.* **2005**, 44, 6841.
2. a) Meyer, G.J. *Chem. Soc. Rev.* **2009**, 38, 115. b) Watson, D.F.; Meyer, G.J. *Ann. Rev. Phys. Chem.* **2005**, 56, 119.
3. McCusker, J.K. *Acc. Chem. Res.* **2003**, 36, 876.
4. a) Smeigh, A.L.; Creelman, M.; Mathies, R.A.; McCusker, J.K. *J. Am. Chem. Soc.* **2008**, 130, 14105. b) Juban, E.A.; Smeigh, A.L.; Monat, J.E.; McCusker, J.K. *Coord. Chem. Rev.* **2006**, 250, 1783. c) Monat, J.E.; McCusker, J.K. *J. Am. Chem. Soc.* **2000**, 122, 4092.

Session III

Advances in Two-Dimensional Electronic Spectroscopy: Applications to Model Systems and the Reaction Center of Photosystem II

Jennifer P. Ogilvie, Principal Investigator

Patrick Tekavec, Postdoctoral Research Associate

Department of Physics and Biophysics, University of Michigan, 450 Church St., Ann Arbor, MI, 48197

Email: jogilvie@umich.edu; Web: <http://www-personal.umich.edu/~jogilvie/>

Overall research goals: Although energy transfer processes in photosynthesis have been studied extensively with nonlinear optical spectroscopy, the electronic couplings governing the energy transfer are usually inferred indirectly. Most nonlinear spectroscopies are inherently one-dimensional, revealing broad features that mask individual transitions and the electronic coupling between them. Two-dimensional electronic spectroscopy (2DES) can uncover these details, revealing the underlying mechanisms that determine electronic line shape, to provide a more direct view of energy transfer with high spectral and temporal resolution. The goals of this research program are to 1) push the capabilities of 2DES as a powerful and quantitative method for studying energy transfer in photosynthesis, 2) develop methodology for simple implementation of two color 2DES (2C2DES) to permit studies over a broad frequency range (the visible to the near infrared) and 3) use 2C2DES to study the structure-function relationship in bacterial and plant photosystems.

Significant achievements 2007-2009: In Years 1-2 of the grant period we implemented two different methods for 2C2DES. Both of these experiments are now functioning well,^{1,2} permitting studies of energy and charge transfer over a broad range of frequencies relevant in photosynthesis. The first implementation is based on the standard non-collinear approach while the second implementation is a simplified method that employs a pulse-shaper in a pump-probe geometry. Both methods offer complementary advantages. For example, the first implementation permits polarization control, which provides access to information about the orientation of coupled transition dipoles. The second (pulse-shaping) method removes several experimental difficulties that complicate the acquisition of 2D spectra.³ In addition, this method is readily combined with a continuum probe, providing information about electronic coupling and energy transfer over a broad frequency range from the visible to near-infrared in a single measurement.⁴ The pulse-shaping method allows a simple pump-probe experiment to be transformed into a 2D spectrometer with the addition of a pulse-shaper into the pump pulse, lowering the technological barrier to implementing 2D spectroscopy for the many groups who are already performing pump-probe measurements. With the continuum probe, this implementation will be particularly useful for our studies of LH2, where the carotenoid and bacteriochlorophyll transitions can be accessed in a single 2D measurement.

We have demonstrated the pulse-shaper approach to 2C2DES on a simple dye system.³ To illustrate 2C2DES with a continuum probe we have studied the laser dye N, N'-bis (2,6-dimethylphenyl) perylene-3,4,9,10-tetracarboxylicdiimide (PERY) dissolved in DMSO.⁴ This

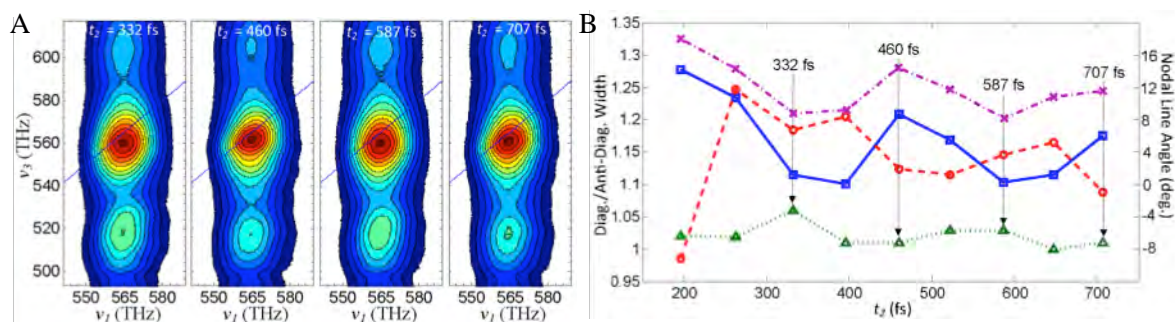

Figure 1. A: Absorptive 2D spectra for PERY in DMSO at different waiting times t_2 indicated by the arrows in B: Ratio of diagonal to anti-diagonal widths for the central peak (solid blue), lower peak (dashed red), and upper peak (dotted green), showing modulation with a ~ 240 fs period. The angle of the nodal line in the central peak (dash-dotted purple) in the imaginary 2D spectrum exhibits similar modulation.⁴

system has been previously studied by other third-order nonlinear spectroscopies, and is known to exhibit strong vibrational wavepacket dynamics. Such dynamics have been observed in natural photosynthetic systems, motivating the need to understand their influence on 2D electronic spectra. Figure 1 shows how vibrational wavepacket motion modulates the ellipticity of the 2D lineshape as a function of “waiting time” t_2 . Since the ellipticity of diagonal peaks in the 2D spectrum is frequently used as a measure of inhomogeneous broadening, this study points to the importance of including relevant vibrational degrees of freedom for proper interpretation of the lineshapes.⁴ We are currently simulating the effects of finite pulse duration and pulse chirp on 2D spectra to allow us to also take these factors into account in understanding our 2D data.

With assistance from Professor Charles Yocum in sample preparation, the first natural photosynthetic system we have studied is the reaction center of photosystem II (PSII) from spinach. Figure 2 shows preliminary data of the room temperature 2D spectrum, taken at different waiting times. The lineshape of the $t_2=0$ spectrum provides insight into site energies, static disorder, the interactions between chromophores and their local environment, and electronic couplings between chromophores. In subsequent spectra at longer t_2 values, the main peak shifts to lower frequencies, indicating downhill energy transfer and charge transfer processes. We are simulating 2D spectra based on current models of energy and charge transfer for direct comparison with our data.

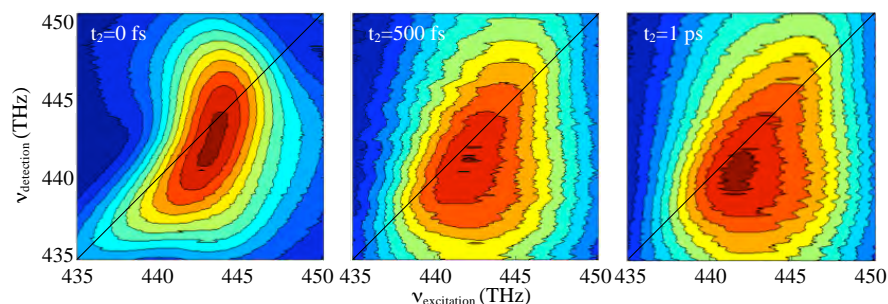

Figure 2. Room temperature 2D spectra of the reaction center of PSII at different waiting times t_2 .

Science objectives for 2009-2010:

- 2C2DES experiments on the PSII reaction center at room temperature and 77K to study the initial energy and charge transfer events. Simulated 2D spectra based on current models of PSII will be tested against the experimental data, providing direct feedback for these models.
- 2C2DES experiments on LH2 at room temperature and 77K to study: 1) the energy transfer from carotenoids to bacteriochlorophyll rings and 2) energy transfer between the B800 and B850 rings. Modelling of the 2D data to extract values of the site energies, static disorder and electronic couplings between chromophores.
- Experiments and modeling of the effect of pulse chirp on 2D spectra in model systems.

References to work supported by this project 2007-2009:

1. K. L. M. Lewis, J. A. Myers, P. F. Tekavec, J. P. Ogilvie, “Two-color two-dimensional Fourier transform spectroscopy of energy transfer,” *Ultrafast Phenomena XVI* (2008) in press.
2. J. Myers, K. L. M. Lewis, P. F. Tekavec, J. P. Ogilvie, “Two-color two-dimensional Fourier transform spectroscopy with a pulse-shaper,” *Ultrafast Phenomena XVI* (2008) in press.
3. J. A. Myers, K. L. M. Lewis, P. F. Tekavec, J. P. Ogilvie, “Two-color two-dimensional Fourier transform electronic spectroscopy with a pulse-shaper,” *Optics Express*, **16**: 22 (17420-17428) (2008).
4. P. F. Tekavec, J. A. Myers, K. L. M. Lewis, J. P. Ogilvie, “Two-dimensional Fourier transform electronic spectroscopy with a continuum probe,” *Optics Letters*, **34**: 9 (1390-1392) (2009).
5. J. P. Ogilvie and K. J. Kubarych, “Multidimensional Electronic and Vibrational Spectroscopy: An Ultrafast Probe of Molecular Relaxation and Reaction Dynamics” *Adv. Atom. Mol. Opt. Phys.* **57**: (249-321) (2009).

The Water-Splitting Apparatus of Photosystem II

Michael Seibert, Principal Investigator

National Renewable Energy Laboratory, 1617 Cole Blvd., Golden, CO 80401

E-mail: mike.seibert@nrel.gov; Web: http://www.nrel.gov/research_fellows/seibert.html

Collaborators: Dr. Boris Semin, Moscow State University, Moscow, Russia; Dr. Ryszard Jankowiak, Kansas State University; Dr. Rafael Picorel, CSIC, Zaragoza, Spain.

Overall research goals: The O₂-evolving complex (OEC) of photosystem II (PSII), composed of a 4-Mn cluster, a Ca²⁺ cation and 1-2 chloride anions, catalyzes water oxidation (electron extraction) and O₂ synthesis. However, the mechanism of cofactor function in the synthesis of molecular O₂ is still not clear. Consequently, the objective of this project is to study the discrete function of each catalytic ion.

Significant achievements in 2007-2009: At the beginning of this funding period, we examined the functional properties of PSII membrane fragments from which Ca²⁺ was depleted (PSII[-Ca]) by 2M NaCl treatment. Ca²⁺ extraction inhibits 90% of the O₂ evolution, but unexpectedly 70-80% of continuous, light-driven electron transport (ET) across the PSII membrane remained. Ca²⁺ depletion in the presence of a chelator (normally used to deplete Ca²⁺ from PSII) inhibits both reactions, which explains why ET without O₂ evolution in Ca-depleted PSII was not observed earlier. Furthermore, extraction of Cl⁻ ions from PSII[-Ca] stops ET. Thus in the absence of the Ca²⁺ ion, the Mn cluster is able to oxidize substrate water (possibly OH⁻), and binding of chelator molecules to the Mn cluster inhibits this reaction. Continuous ET is probably supported by a sub-cycle that occurs within the main S-state cycle between the S3 and S4 states. Effective inhibition of ET by Cl⁻ extraction demonstrates the involvement of the anion in substrate oxidation and supports the hypothesis that Cl⁻ participates in the regulation of the redox potential of the Mn cluster relative to Y_Z[•]/Y_Z pair. The absence of O₂ synthesis, but the presence of substrate oxidation (ET) in PSII[-Ca] membranes, can be explained by the loss of the binding site for one of the substrate water molecules in the absence of Ca²⁺.

Our ability to decouple O₂ synthesis from ET in PSII[-Ca] membranes now allows us to probe the function of different Mn ions in the PSII Mn/Ca/Cl complex. It is known that in PSII[-Ca] membranes, Mn cations can be reduced easily by exogenous reductants including Fe(II). Several years ago we showed the efficient, tight, and specific binding of Fe(III) cations formed from Fe(II) in the light at the Mn-binding site(s) in Mn-depleted PSII membranes. Consequently, we suggest the reduction of Mn ions by Fe(II) cations in PSII[-Ca] should be accompanied by the binding of the resultant Fe(III) cations to the same site(s) as the Mn displaced from the OEC. To facilitate this investigation, we developed a simple, rapid, and sensitive colorimetric assay for Mn determination in PSII material, which doesn't require EPR or AA spectroscopy. Our results show that dark incubation of PSII[-Ca] samples with Fe(II) cations releases 2 Mn ions from the OEC. Measurement of the concentration dependence of the Fe(II) effect demonstrated that one of two extractable Mn ions is more sensitive to reduction by Fe(II) and allows us to prepare PSII samples with 2 or 3 Mn ions (see figure). Binding of Fe(III) cations to unoccupied Mn-binding

sites suggests the formation of a chimeric $2\text{Mn}/\geq 2\text{Fe}$ cluster during the reduction of Mn(III or IV) cations by Fe(II). In PSII samples with a chimeric cluster, charge recombination ($\text{S}_2/\text{Q}_\text{A}^-$) occurs at a higher rate than in active PSII[-Ca] membranes, but at a lower rate than in PSII lacking a Mn cluster ($\text{Y}_\text{Z}^\bullet/\text{Q}_\text{A}^-$). Notably, water oxidation, observed above in PSII[-Ca] membranes, is still present in the chimeric system containing only 2 of the normal 4 Mn cations, and this also disappears after Cl^- extraction. These results show that only 2 Mn are really necessary for substrate oxidation, whereas the other two Mn ions probably play a structural role.

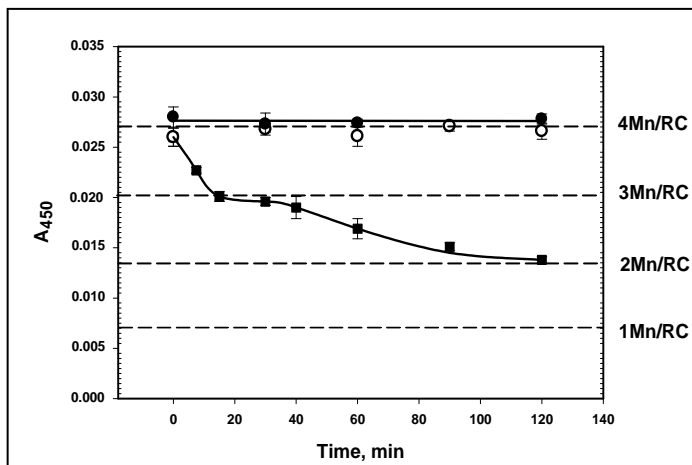

Science objectives for 2009-2010:

- Conduct a comparative investigation of the functional properties of PSII membranes with only 2 Mn cations in the OEC relative to PSII samples with a chimeric OEC.
- Explore the EPR properties of PSII membranes with a chimeric OEC.
- Investigate the nature of Mn/Fe metal cation binding in the OEC using selective extraction of bound cations.

References to work supported by this project 2007-2009:

1. Semin, B.K., L.N. Davletshina, A.A. Bulychev, I.I. Ivanov, M. Seibert, and A.B. Rubin (2007) "Effect of Calcium Chelators on the Formations and Oxidation of the Slowly Relaxing Reduced Plastoquinone Pool in Calcium-Depleted PSII Membranes. Investigation of the F_0 Yield", *Biochemistry (Moscow)* **72(11)**, 1482-1494.
2. Makarova, V.V., S. Kosourov, T.E. Krendeleva, B.K. Semin, G.P. Kukarskikh, A.B. Rubin, R.T. Sayre, M.L. Ghirardi, and M. Seibert (2007) "Photoproduction of hydrogen by sulfur-deprived *Chlamydomonas reinhardtii* mutants with impaired photosystem II photochemical activity," *Photosynth Res.* **94**, 79-89.
3. Semin, B.K., L.N., Davletshina, I.I. Ivanov, A.B. Rubin and M. Seibert (2008) "Decoupling of the processes of molecular oxygen synthesis and electron transport in Ca^{2+} -depleted PSII membranes", *Photosynthesis Res.* **98**, 235-249.
4. Dang, N.C., V. Zazubovich, M. Reppert, B. Neupane, R. Picorel, M. Seibert, R. Jankowiak (2008) "The CP43 proximal antenna complex of higher plant photosystem II revisited: Modeling and hole burning study (I)," *J. Phys. Chem. B* **112**, 9921-9933.
5. Dang, N.C., V. Zazubovich, M. Reppert, B. Neupane, M. Seibert, R. Jankowiak (2008) "Low Energy Chlorophyll States in the CP43 antenna protein complex: Simulation of various optical spectra (II)," *J. Phys. Chem. B* **112**, 9934-9947.
6. Semin, B.K., and M. Seibert (2009) "A simple colorimetric determination of the manganese content in photosynthetic membranes", *Photosynthesis Res.* **100**, 45-48.

Regulation of Photosynthetic Light Harvesting

Krishna K. Niyogi, Principal Investigator

Graham R. Fleming, Co-PI

Graham Peers, Zhirong Li, Postdoctoral Research Associates

Thuy Truong, Matt Brooks, Graduate Students

Department of Plant and Microbial Biology, University of California and Physical Biosciences Division, Lawrence Berkeley National Laboratory, Berkeley, CA 94720

Email: niyogi@nature.berkeley.edu; Web: <http://pmb.berkeley.edu/~niyogi/>

Overall research goals: Photosynthetic light-harvesting systems are regulated, protected against photo-oxidative damage, self-assembled into supercomplexes, and rely on a subtle balance of electronic interactions to produce a highly robust system. In this project, we apply a multidisciplinary approach that combines genetic and biochemical techniques with ultrafast spectroscopy and modeling to understand the mechanism(s) by which green plants and algae regulate the efficiency of light harvesting in Photosystem II (PSII). In response to rapid fluctuations in light intensity, a nonphotochemical quenching (qE) mechanism that regulates photosynthetic light harvesting is induced rapidly by changes in thylakoid lumen pH. Our specific aims are (1) to elucidate how qE is turned on and off at a molecular level, (2) to investigate differences in how qE works in different photosynthetic organisms, (3) to assess the relative contributions of different proposed quenching mechanisms, and (4) to investigate how qE actually protects PSII.

Significant achievements 2007-2009: Previous work in our groups has led to a model in which qE dissipates excess absorbed light energy via a charge transfer (CT) mechanism that involves chlorophyll and xanthophyll pigments. In plants, the PsbS protein associated with PSII appears to sense lumen pH and turn on qE in specific antenna (LHC) proteins. We showed that generation of a carotenoid radical cation via CT occurs in isolated minor LHCs (CP29, CP26, and CP24) but not in the major trimeric LHCII. By selectively removing individual chlorophyll binding sites from CP29, we were able to identify chlorophylls bound to the A5 and B5 sites as the pigments responsible for the CT quenching. By characterizing a suppressor of a mutation affecting zeaxanthin accumulation, we showed that Lut is able to substitute directly for zeaxanthin in qE. In the green alga *Chlamydomonas reinhardtii*, qE is inducible by growth in high light and is necessary for optimal fitness in a variable light environment. The qE in *C. reinhardtii* occurs by a biophysical mechanism similar to that in plants, but it involves LHCSR proteins, which are ancient members of the LHC superfamily that are not found in plants.

Science objectives for 2009-2010:

- One of the keys to elucidating how qE is turned on and off is understanding how PsbS becomes activated by protonation, what protein(s) it interacts with, and what changes in them are induced. We have successfully expressed a His-tagged version of PsbS in *E. coli*, and will use solid-state NMR studies in collaboration with Prof. Mei Hong (Iowa State Univ.) to investigate conformational changes of PsbS that occur upon protonation. We are using His-tagged PsbS transgenic plants and protein crosslinking to investigate which PSII proteins are adjacent to PsbS.
- To complement the biochemical approaches, we are characterizing new suppressor mutants that no longer require PsbS for induction of chlorophyll fluorescence quenching.
- Two *PSBS* genes are present in the *C. reinhardtii* genome. They are expressed, and even upregulated in response to high light, however immunoblotting and proteomic analyses of thylakoids have not detected the PsbS protein in this alga. We will use artificial miRNA constructs to block expression of *PSBS1* and *PSBS2* and determine if PsbS plays a role in qE in *C. reinhardtii*.

- The role of LHCSR proteins in *C. reinhardtii* will be explored further this year. We will investigate CT quenching in LHCSR3 and determine the function of LHCSR1 using a new mutant isolated by TILLING. LHCSR3 has putative pH-sensing amino acid residues, and we are performing site-directing mutagenesis to determine if these are required for qE *in vivo*.

References to work supported by this project 2007-2009:

1. Merchant SS, Prochnik SE, Vallon O, Harris EH, Karpowicz SJ, Witman GB, Terry A, Salamov A, Fritz-Laylin LK, Maréchal-Drouard L, Marshall WF, Qu LH, Nelson DR, Sanderfoot AA, Spalding MH, Kapitonov VV, Ren Q, Ferris P, Lindquist E, Shapiro H, Lucas SM, Grimwood J, Schmutz J, Cardol P, Cerutti H, Chanfreau G, Chen CL, Cognat V, Croft MT, Dent R, Dutcher S, Fernández E, Fukuzawa H, González-Ballester D, González-Halphen D, Hallmann A, Hanikenne M, Hippler M, Inwood W, Jabbari K, Kalanon M, Kuras R, Lefebvre PA, Lemaire SD, Lobanov AV, Lohr M, Manuell A, Meier I, Mets L, Mittag M, Mittelmeier T, Moroney JV, Moseley J, Napoli C, Nedelcu AM, Niyogi K, Novoselov SV, Paulsen IT, Pazour G, Purton S, Ral JP, Riaño-Pachón DM, Riekhof W, Rymarquis L, Schroda M, Stern D, Umen J, Willows R, Wilson N, Zimmer SL, Allmer J, Balk J, Bisova K, Chen CJ, Elias M, Gendler K, Hauser C, Lamb MR, Ledford H, Long JC, Minagawa J, Page MD, Pan J, Pootakham W, Roje S, Rose A, Stahlberg E, Terauchi AM, Yang P, Ball S, Bowler C, Dieckmann CL, Gladyshev VN, Green P, Jorgensen R, Mayfield S, Mueller-Roeber B, Rajamani S, Sayre RT, Brokstein P, Dubchak I, Goodstein D, Hornick L, Huang YW, Jhaveri J, Luo Y, Martínez D, Ngau WC, Otiillar B, Poliakov A, Porter A, Szajkowski L, Werner G, Zhou K, Grigoriev IV, Rokhsar DS, Grossman AR (2007). The *Chlamydomonas* genome reveals the evolution of key animal and plant functions. *Science* **318**: 245-251.
2. Avenson TJ, Ahn TK, Zigmantas D, Niyogi KK, Li Z, Ballottari M, Bassi R, Fleming GR (2008). Zeaxanthin radical cation formation in minor light-harvesting complexes of higher plant antenna. *J Biol Chem* **283**: 3550-3558.
3. Peers G, Niyogi KK (2008). Pond scum genomics: the genomes of *Chlamydomonas* and *Ostreococcus*. *Plant Cell* **20**: 502-507.
4. Ahn TK, Avenson TJ, Ballottari M, Cheng, Y-C, Niyogi KK, Bassi R, Fleming GR (2008). Architecture of a charge-transfer state regulating light harvesting in a plant antenna protein. *Science* **320**: 794-797.
5. Logan BA, Terry SG, Niyogi KK (2008). *Arabidopsis* genotypes with differing levels of *psbS* expression differ in photosystem II quantum yield, xanthophyll cycle pool size, and above-ground growth. *Int J Plant Sci* **169**: 597-604.
6. Cheng Y-C, Ahn TK, Avenson TJ, Zigmantas D, Niyogi KK, Ballottari M, Bassi R, Fleming GR (2008). Kinetic modeling of charge-transfer quenching in the CP29 minor complex. *J Phys Chem B* **112**: 13418-13423.
7. Niyogi KK (2008). Photoprotection and high light responses. In: *The Chlamydomonas Sourcebook, Vol 2: Organellar and Metabolic Processes*, Stern D, ed (San Diego: Elsevier), pp. 847-870.
8. Avenson TJ, Ahn TK, Niyogi KK, Ballottari M, Bassi R, Fleming GR (2009). Lutein can act as a switchable charge-transfer quencher in the CP26 light-harvesting complex. *J Biol Chem* **284**: 2830-2835.
9. Ahn TK, Avenson TJ, Peers G, Li Z, Dall'Osto L, Bassi R, Niyogi KK, Fleming GR (2009). Investigating energy partitioning during photosynthesis using an expanded quantum yield convention. *Chem Phys* **357**: 151-158.
10. Li Z, Wakao S, Fischer BB, Niyogi KK (2009). Sensing and responding to excess light. *Annu Rev Plant Biol* **60**: 239-260.
11. Jung H-S, Niyogi KK (2009). Quantitative genetic analysis of thermal dissipation in *Arabidopsis*. *Plant Physiol* **150**: 977-986.
12. Li Z, Ahn TK, Avenson TJ, Ballottari M, Cruz JA, Kramer DM, Bassi R, Fleming GR, Keasling JD, Niyogi KK (2009). Lutein accumulation in the absence of zeaxanthin restores nonphotochemical quenching in the *Arabidopsis thaliana npq1* mutant. *Plant Cell* **21**: 1798-1812.
13. Kim E-H, Li X-P, Razeghifard R, Anderson JM, Niyogi KK, Pogson BJ, Chow WS (2009). The multiple roles of light-harvesting chlorophyll *a/b*-protein complexes define structure and optimize function of *Arabidopsis* chloroplasts: a study using two chlorophyll *b*-less mutants. *Biochim Biophys Acta* **1787**: 973-984.

Session IV

Retrograde Signaling in *Arabidopsis*

Joanne Chory, Principal Investigator

Hou-Sung Jung, Juan Perez, Jesse Woodson, postdocs; Emilia Pires, Ph.D. student

Plant Biology Laboratory, The Salk Institute for Biological Studies, La Jolla, CA 92037

Email: chory@salk.edu

Overall research goals: Chloroplasts of higher plants contain about 3000 proteins of which more than 95% are encoded by nuclear genes. This necessitates a tight coordination of gene expression that involves two-way signaling between these spatially separated genomes. Thus, while plastid differentiation and development are largely under nuclear control, developmentally arrested or damaged plastids can regulate expression of a subset (hundreds) of nuclear genes via multiple retrograde signaling pathways. In previous studies, we utilized a molecular genetic approach to select for *Arabidopsis* mutants in which chloroplast and nuclear gene expression had become uncoupled. Using these mutants, we showed that perturbations in the tetrapyrrole biosynthesis pathways around the chlorophyll-heme branchpoint generate a signal that causes transcriptional repression of nuclear genes encoding plastid-localized proteins. Other signals can also trigger retrograde signaling. Using genetics and genomics, we identified two components [GUN1 (plastid-localized) and ABI4 (a transcription factor)] of a common signaling pathway that integrates multiple retrograde signals to regulate gene expression in the nucleus. The major goals of these studies are to continue to define the signal(s) and signaling pathways from chloroplasts that regulate nuclear gene transcription. Specifically, we will integrate genetic, molecular, and biochemical approaches in *Arabidopsis* in an effort to: (1) Determine the precise function of chloroplast nucleoid-localized GUN1 in retrograde signaling; (2) Identify proteins in the common signaling pathway that acts between GUN1 and nuclear-localized ABI4; (3) Dissect genetically the signaling pathway(s) initiated from the redox state of the plastoquinone pool in response to high light. These studies should provide an increased understanding of the input signals and retrograde signaling pathways that control nuclear gene expression in response to the functional state of chloroplasts, and should ultimately influence our ability to manipulate plant growth, development, and photosynthesis.

Significant achievements 2008-2009:

- (1). GUN1, a pentatricopeptide repeat (PPR) containing protein, plays an important role in multiple plastid-to-nucleus retrograde signaling pathways. PPR motif-containing proteins are a vastly expanded, nuclear-encoded, gene family in plants that function in processing, editing, stability and translation of RNA molecules within mitochondria and plastids. However, GUN1 is unusual in that it also contains a second domain, termed the SMR domain, which is involved in DNA repair. We performed a biochemical characterization of recombinant *A. thaliana* GUN1 and showed that it can bind DNA and has non-specific Mg^{2+} -dependent endonuclease activity, suggesting that its function may be distinct from known PPR proteins. The endonuclease activity resides in the SMR domain; however the 10 PPRs are also required for GUN1 function. Chemical modification with Diethyl Pyrocarbonate (DEPC) inactivated the enzyme, suggesting that histidine residues play a decisive role in the catalytic mechanism of this nuclease. We used site-directed mutagenesis to generate a series of substitution mutations where conserved histidine residues (His-787, His-828) were replaced by asparagine (Asn). Mutation of either histidine largely abolished Mg^{2+} -dependent catalytic activity, indicating that both residues are required for catalytic activity.
- (2). To identify additional proteins involved in GUN signaling, we have continued to screen for gain-of-function mutants using activation tagging. 600,000 T2 seedlings from 20,000

independently transformed lines were tested and three new *gun* mutant lines were recovered. Two of the lines contained insertions that caused loss of function mutations in known *gun* genes: *gun3* and *chlD*. However, mutant GAT003 is a dominant gain-of-function mutation that overexpresses ferrochelatase I (FC1). Overexpression of the 69% identical ferrochelatase II (FC2) does not result in a *gun* phenotype although overproduced tagged-variants of both proteins were shown to be co-localized in plastids and accumulate to similar levels. Furthermore, a T-DNA insertion in FC1 partially suppresses the *gun5* phenotype suggesting that FC1 plays an important role in plastid to nucleus retrograde signaling.

- (3). Exposure to high light (HL) inhibits photosynthesis and causes photo-oxidative stress. To deal with this stress, plants need efficient chloroplast-to-nucleus signal transduction because of the limited genetic information of chloroplasts. Previous reports suggest that the reduced/oxidized (redox) state of the plastoquinone (PQ) pool initiates the signaling, but the molecular mechanism is largely unknown. To understand the chloroplast-to-nucleus signal transduction mechanism under HL stress, genomics and genetics approaches were taken. Reduced PQ regulates more than 500 nuclear genes, and detailed expression analyses of two representative genes, *Ascorbate Peroxidase 2 (APX2)* and *Early Light-Inducible Protein 2 (ELIP2)*, indicated that there are at least two pathways involved in chloroplast signaling from a reduced PQ pool. Characterization of *APX2* promoter region and the kinetics of *APX2* induction in multiple knockout mutants determines that the *APX2* induction by the reduced PQ is mediated by heat shock transcription factors, which bind to the heat shock elements in the *APX2* promoter. To understand molecular mechanisms of the reduced PQ-driven *ELIP2* induction, mutants were isolated from EMS-mutagenized transgenic lines, in which the expression of the luciferase gene is under the control of the *ELIP2* promoter. Currently, we have identified mutations in six genes, and identified three of these genes by positional cloning. Two of the genes are predicted to encode RNA-binding proteins, and the 3rd is predicted to be a histone acetyltransferase (HAC1).

Science objectives: 2009-2010:

- *GUN1 studies.* We will continue to explore the biochemical function of GUN1. A major priority for the upcoming year is to find the RNA or DNA that it binds. *GUN1* is the founding member of a small gene family of PPR-SMR proteins in *Arabidopsis*. Genetic studies indicate that several of the other *gun1*-like proteins also play a role in plastid signaling. Higher order mutants will be made and assessed for their possible roles in retrograde signaling.
- *Ferrochelatase studies.* The role of FC1 in *gun* signaling will be explored genetically by testing overexpression and knockout lines of FC1 combined with known *gun* mutations and other mutations affecting the tetrapyrrole pathway. Analyses of the *gun* phenotypes of these lines and measurements of their tetrapyrrole intermediates such as Mg-ProtoIX and heme will help determine the nature of the *gun* signal. Because overproduction of FC1 but not FC2 results in a *gun* phenotype, the sub-plastid localization of these two proteins in *Arabidopsis* will be determined. This information is crucial to understand how and where the *gun* signal originates.
- We will clone new genes from the high light stress screen (3 remain). Molecular functions of the 3 currently isolated factors and possible interactions between these pathways will be determined.
- Genetic screens for new retrograde signaling mutants will continue throughout the award period.

References to work supported by this project, which was initiated in May, 2008:

- Woodson, J.D. and J. Chory. 2008. Coordination of gene expression between organellar and nuclear genomes. *Nat. Rev. Genet.* **9**:383-395.
- Adhikari, N. R. Orler, J. Chory, J.E. Froehlich, and R.M. Larkin. (2009). Porphyrins promote the association of Genomes Uncoupled 4 and a Mg-chelatase subunit with chloroplast membranes. *J. Biol. Chem.* Epub 2009 Jul 15.

Regulation of Thylakoid Membrane Lipid Biosynthesis in Response to the Environment

Christoph Benning, Principal Investigator

Changcheng Xu (Postdoctoral Research Associate), Eric R. Moellering (Graduate Student)
Dept. of Biochemistry and Molecular Biology, Michigan State University, East Lansing, MI 48824

Email: benning@msu.edu; Web: <http://www.bch.msu.edu/faculty/benning.htm>

Overall research goals: The overall goal is to provide a mechanistic understanding of the biosynthesis of polar lipids required for the assembly of photosynthetic membranes in chloroplasts. Parallel sets of lipid biosynthetic enzymes at the ER and the chloroplast envelope membranes are involved, requiring lipid transfer between membranes and intricate regulation to achieve the observed lipid composition of photosynthetic membranes (Fig. 1). Environmental factors such as low phosphate availability affect the activity of different lipid assembly pathways. Genetics in *Arabidopsis* is used to dissect these parallel lipid assembly pathways, to identify missing factors and to determine the role of individual enzymes and pathways involved in the assembly of lipids destined for the photosynthetic membrane. Specific objectives were (1) to determine the role of the DGD1 SUPPRESSOR1 (DGS1) discovered in a suppressor screen in the digalactolipid-deficient *dgd1* mutant background, and (2) to identify the processive galactolipid:galactolipid galactosyltransferase (GGGT) responsible for oligogalactolipid formation in isolated chloroplasts and the *tgd* chloroplast lipid trafficking mutants.

Figure 1. *Interaction of the ER and plastid in galactoglycerolipid biosynthesis.* Reactions of the plastid pathway are indicated in red, of the ER-pathway in blue, and those common to both pathways in purple. Not shown is the phosphate stress induced pathway of galactoglycerolipid biosynthesis involving MGD2/3 and DGD2 and GGGT. The Plasma membrane (PM), a chloroplast (Chl), thylakoids (Thy), the endoplasmic reticulum (ER), a plastid envelope ER-contact site (PLAM) and the fatty acid synthase complex (FAS) are shown. Lipids: acyl-ACP, acyl-acyl carrier protein; acyl-CoA, acyl coenzyme A; DAG, diacylglycerol; DGDG, digalactosyldiacylglycerol; G3P, glycerol 3-phosphate; L-PtdOH, lysophosphatidic acid; MGDG, monogalactosyldiacylglycerol; PtdCHO, phosphatidylcholine; PtdOH, phosphatidic acid. Enzymes are indicated by numbers: 1, plastid G3P:acyl-ACP acyltransferase (ATS1/ACT1 in *Arabidopsis*); 2, plastid L-PtdOH:acyl-ACP acyltransferase; 3, plastid PtdOH phosphatase; 4, ER G3P:acyl-ACP acyltransferase; 5, ER L-PtdOH:acyl-ACP acyltransferase; 6, ER PtdOH phosphatase; 7, DAG:CDP-choline phosphotransferase; 8, PtdOH importer (TGD1,2,3 in *Arabidopsis*); 9, DAG:UDP-Gal galactosyltransferase (MGDG synthase, MGD1 in *Arabidopsis*); 10, MGDG:UDP-Gal galactosyltransferase (DGDG synthase, DGD1 in *Arabidopsis*).

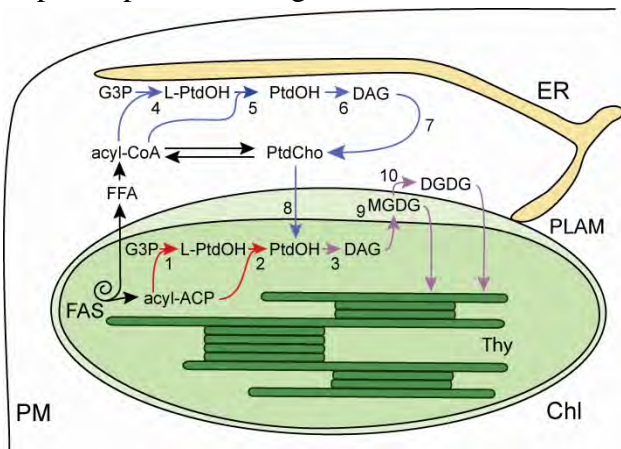

Significant achievements 2008-2009: 1. DGS1 is a mitochondrial outer membrane protein. A dominant-negative gain-of-function mutation is responsible for restoring the galactolipid phenotype in the *dgd1;dgs1-1* double mutant. The *dgs1-1* point mutation causes the accumulation of hydrogen peroxide, which activates the alternative DGD1-independent galactoglycerolipid biosynthetic pathway. Based on these preliminary data, we tested a hypothesis suggesting that the wild-type DGS1 protein might be involved in the regulation of the alternative galactoglycerolipid pathway either by altering the levels of reactive oxygen species or by acting as a membrane tethered transcription factor (MTF). The MTF hypothesis was not confirmed because no processing of a DGS1-GFP fusion protein was observed under a number of different growth conditions. Furthermore, a new *dgs1-2* T-DNA insertion null allele did not suppress or affect the lipid phenotype in a *dgd1;dgs1-2* double mutant. The only discernable phenotype of plants carrying the *dgs1-2* allele was decreased viability of aged seeds. An

extensive negative data set let us conclude that the wild-type DGS1 protein is not directly involved in the regulation of lipid metabolism. 2. A genetic screen was designed to identify restorer's of the *dgd1* galactolipid phenotype (low amounts of digalactolipid) in a *dgd1;tgdl-2* double mutant, which accumulates oligogalactolipids as a result of the *tgdl-2* mutation that primarily causes a deficiency in the import of lipids from the ER into the plastid. Instead of the gene for GGGT, a new *fad6* allele (*fad6-2*) was identified in this background that met the criteria for a restorer. The *FAD6* gene encodes a plastid located fatty acid desaturase. Independently constructed *fad6-1;tgdl* and *fad6-1;tgdl4* double mutants showed severely compromised growth confirming that the import of polyunsaturated fatty acid-containing lipid species from the ER essential in the *fad6* mutant background is disrupted. 3. We ultimately identified GGGT by a reverse genetic approach targeting a presumed beta-glucosidase. It was known that these type of hydrolases can processively catalyze the reverse reaction. We identified two independent T-DNA null alleles of the GGGT encoding gene that completely lack the ability to produce oligogalactolipids. 4. During an MSU undergraduate summer student program in plant genomics we mapped and identified the last missing plastid located fatty acid desaturase, FAD4.

Science objectives for 2009-2010: 1. The identification of the GGGT-encoding gene provides the means to probe GGGT function in plants and in isolated plastids. A number of treatments induce GGGT activity, such as freezing, leaf infiltration with metal ions, dehydration etc. that need to be compared to determine the common principles. Comparing the spectrum and effect of these treatments on lipid biosynthesis, photosynthesis, chloroplast ultrastructure, and growth in the wild type and the mutant lacking GGGT will provide a more accurate assessment of the physiological functions of GGGT. 2. To test whether oligogalactolipid accumulation in the lipid trafficking deficient *tgdl* mutants is indeed due to activation of GGGT, a GGGT deficient mutant allele will be introduced into the different *tgdl* mutant backgrounds. We expect that accumulation of oligogalactolipids in the mutants will be abolished. If activation of GGGT has beneficial compensatory functions in the *tgdl* mutants, the double mutants should have a more severe growth defect or cell biological phenotype. 3. The genetic analysis suggests that GGGT has a processive galactosyltransferase activity giving rise to oligogalactolipids and is the galactolipid biosynthetic enzyme originally described to be active in isolated plastids. We will establish an *in vitro* assay for the analysis of GGGT activity, substrates and cofactors following the production of the recombinant protein in a suitable system. Once established, this will allow us to study the regulation of this membrane enzyme by specific lipids and physical properties of microsomes or lipid bilayers.

References to work supported by this project 2008-2009:

- Xu, C., Moellering, E.R., Fan, J., and C. Benning. 2008. Mutation of a mitochondrial outer membrane protein affects chloroplast lipid biosynthesis. *Plant J.* 54:163-175. (Fully supported by the DOE grant)
- Xu, C., Fan, J., Cornish A.J., and C. Benning. 2008. Lipid trafficking between the endoplasmic reticulum and the plastid in Arabidopsis requires the extraplastidic TGD4 protein. *Plant Cell*, 20:2190-2204. (The mutant was isolated by Xu, C. and the gene mapped with support from the DOE grant)
- Gao, J., Ajjawi, I., Manoli III, A., Sawin, A., Xu, C., Froehlich, J.E., Last R.L., and C. Benning. 2009. FATTY ACID DESATURASE 4 of Arabidopsis encodes a protein distinct from characterized fatty acid desaturases. *Plant J.*, in press. (Gao J. and Xu. C. majorly contributed to the mapping of the gene while supported by the DOE grant)
- Xu, C., Moellering, E.R., Muthan, B., Fan, J., and C. Benning. 2009. Unidirectional lipid transport mediated by TGD Proteins in Arabidopsis. Submitted (Fully supported by the DOE grant)
- Reviews and Book Chapters Acknowledging DOE Support of Work on Lipid Metabolism in the LAB*
- Benning, C. 2008. A role for lipid trafficking in chloroplast biogenesis. *Prog. Lipid. Res.* 47: 381-389.
- Benning, C., Garavito R.M. and M. Shimojima. 2008. Sulfolipid biosynthesis and function. In: *Advances in Photosynthesis and Respiration*. Govindjee (series ed). Vol 27. Sulfur metabolism in phototrophic organisms. Hell, R., Dahl, C., Knaff, D., and T. Leusteck, (eds). Springer (Netherlands), pp. 185-200.
- Benning, C. 2009. Mechanisms of lipid transport involved in organelle biogenesis in plants. *Annu. Rev. Cell. Dev. Biol.* Online ahead of print.

Poster Session II

Mapping Structure with Function in Natural and Biomimetic Photosynthesis

David M. Tiede, Principal Investigator

Lin X. Chen, O. G. Poluektov, Lisa M. Utschig, Gary Wiederrecht, Co-PIs

Karen Mulfort, Shana Bender, Iltai Kim, Jenny Lockard, Postdoctoral Research Associates

9700 S. Cass Ave., Argonne National Laboratory (ANL), Argonne, IL 60439

Email: tiede@anl.gov ; Web: http://www.cse.anl.gov/Fundamental_Interactions/Solar_Conversion.shtml

Overall research goals: This program investigates fundamental mechanisms for solar energy capture and conversion in natural and biomimetic photosynthetic architectures by concomitant mapping of time-resolved *in-situ* structure with function in three regimes. (1) Photosynthetic structure characterization in solution using coordinate modeling of continuous and time-resolved synchrotron X-ray scattering. (2) Ultrafast imaging of solar energy flow at the molecular scale within individual reaction center proteins and light-harvesting complexes proteins by applying ultrafast transient optical absorption spectroscopy analyses on single 3D crystals. (3) Ultrafast imaging of photosynthetic solar energy flow at the nanometer scale in natural photosynthetic membranes and in laboratory-produced 2D crystalline arrays of isolated photosynthetic proteins by combining ultrafast pulsed laser excitation with near-scanning and far-field optical microscopy techniques.

Significant achievements 2007-2009: New capabilities were developed for *in-situ* structure determination of photosynthetic supramolecular assemblies and building blocks using X-ray scattering and coordinate-based analysis. The method allows wide angle X-ray scattering to be quantitatively compared with detailed coordinate models suggested from molecular modeling, dynamics simulations, or crystallographic data. The approach has application for structural analyses of both natural and biomimetic supramolecular architectures. Recently, we used these approaches to resolve the solution structure of a newly synthesized supramolecular photocatalyst (Figure 1) and correlate structure with light-initiated ultrafast electron transfer. Correlation between photosynthetic function and crystallographic structure was achieved by ultrafast transient optical spectroscopy measurements of primary electron transfer in single crystals of photosynthetic bacterial reaction centers.

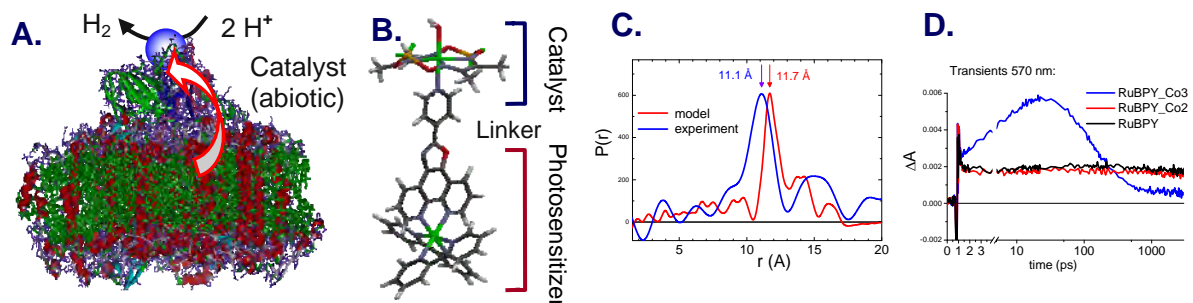

Figure 1. Modular photocatalyst designs for solar hydrogen production. Part A. Photosystem I-catalyst hybrid. Part B. Supramolecular photosensitizer-cobaloxime catalyst architecture. Part C. Solution structure characterization for B. Part D. Ultrafast photochemistry for B.

Science objectives for 2009-2010:

- The development of an experimental facility for laser-induced, time-resolved solution x-ray scattering with 100 ps time-resolution at the Advanced Photon Source. This is a first-of-a-kind facility in the U.S. that will enable a new tool for directly detecting atomic-scale configurational dynamics changes along excited-state reaction coordinates. The photosynthetic assemblies to be studied include a series of photosensitizer-linked cobaloxime complexes that function as catalysts for solar-driven hydrogen production, and biomimetic hybrids assemblies that combine photosystem I with the cobaloxime catalysts (Figure 1).

- Polarization-selective cofactor excitation and detection in photosynthetic protein crystals will be used to map out selective cofactor photochemical function with crystalline bacterial RC and LH-RC complexes, and crystalline algal PSI and PSII complexes.
- Techniques for spatially resolving ultrafast solar energy flow in photosynthesis will be developed using localized, nanoparticle surface plasmons as nanoscale point sources for spatially localized light injection into natural and artificial photosynthetic molecular arrays.

References to work supported by this project 2007-2009:

1. X-ray Scattering Combined with Coordinate-Based Analyses for Applications in Natural and Artificial Photosynthesis, D. M. Tiede, K.L. Mardis, and X. Zuo, *Photosyn. Research*, (2009) DOI 10.1007/s11120-009-9475-6.
2. Hydrophobic Dimerization and Thermal Dissociation of Peryleneimide-Linked DNA Hairpins, M. Hariharan, Y. Zheng, H. Long, T. A. Zeidan, G. C. Schatz, J. Vura-Weis, M. R. Wasielewski, X. Zuo, D. M. Tiede, and F. D. Lewis, *J. Am. Chem. Soc.* (2009) *J. Amer. Chem. Soc.* 131(16): 5920-5929.
3. The Conformational Ensemble of a Hexameric Porphyrin Array Characterized Using Molecular Dynamics and Wide-Angle X-ray Scattering, K. L. Mardis, H. M. Sutton, X. Zuo, J.S. Lindsey, and D. M. Tiede, *J. Phys. Chem. A* (2009) **113**: 2516-2523.
4. *In Situ* Measurement of the Preyssler Polyoxometalate Morphology upon Electrochemical Reduction, M. R. Antonio, M.-H. Chiang, S. Seifert, D. M. Tiede, and P. Thiyagarajan, *J. Electroanal. Chem.* (2009) **626**:103-110.
5. Cavity-tailored, Self-sorting Supramolecular Catalytic Boxes for Selective Oxidation, S. J. Lee, S.-H. Cho, K.L. Mulfort, D.M. Tiede, J.T. Hupp, and S.T. Nguyen, *J. Am. Chem. Soc.* (2008) **130**: 16828-16829.
6. Correlating Ultrafast Function with Structure in Single Crystals of the Photosynthetic Reaction Center, L. Huang, G.P. Wiederrecht, S. Schlesselman, C. Xydis, P.D. Laible, D.K. Hanson, D.M. Tiede, *Biochemistry* (2008) **47**: 11387-11389.
7. Electron Paramagnetic Resonance Study of Radiation Damage in Photosynthetic Reaction Center Crystals, L. M. Utschig, S. D. Chemerisov, D. M. Tiede, and O. G. Poluektov, *Biochemistry* (2008) **47**: 9251-9257.
8. Fast energy transfer within a self-assembled cyclic porphyrin tetramer, R.A. Jensen, R.F. Kelley, S. J. Lee, M.R. Wasielewski, J.T. Hupp, D. M. Tiede, *Chem. Comm.* (2008) **16**: 1886-1888.
9. Intramolecular Energy Transfer within Butadiyne-Linked Chlorophyll and Porphyrin Dimer-Faced, Self-assembled Prisms, R. F. Kelley, S. J. Lee, T. M. Wilson, Y. Nakamura, D. M. Tiede, A. Osuka, J. T. Hupp, and M. R. Wasielewski, *J. Am. Chem. Soc.* (2008) **130**, 4277-4284.
10. Global Architecture and Interface: Refining a RNA:RNA Complex Structure Using Solution X-ray Scattering Data, X. Zuo, J. Wang, T. R. Foster, C. D. Schwieters, D. M. Tiede, S. E. Butcher, and Y.-X. Wang, *J. Am. Chem. Soc.* (2008) **130**, 3292-3293.
11. X-ray Scattering for Bio-Molecule Structure Characterization, D. M. Tiede and X. Zuo, in "Biophysical Methods in Photosynthesis" Volume II, (Thijs J. Aartsma and Jörg Matysik, eds.), Series Advances in Photosynthesis and Respiration, Vol. 26, Springer, Dordrecht, pp 151-165 (2008)
12. Coordinative Self-Assembly and Solution-phase X-ray Structural Characterization of Cavity-Tailored Porphyrin Boxes, S. J. Lee, K. L. Mulfort, X. Zuo, A. J. Goshe, P. J. Wesson, J. T. Hupp, and D. M. Tiede, *J. Am. Chem. Soc.* **130**, 836-838 (2008)
13. Time-Resolved High-Field EPR Spectroscopy Of Natural Photosynthesis: Photoinduced Electron Transfer Pathways In Photosystem I, O. Poluektov, L. Utschig, S. Paschenko, K. Lakshmi, D. Tiede, *Photosyn. Res.* **91** (2-3), 150-151 (2007)
14. Photocatalytic probing of DNA sequence by using TiO₂/dopamine-DNA triads, J.L. Liu, X. Zuo, L. de la Garza, Nada M. Dimitrijevic, X. Zuo, D. M. Tiede, T. Rajh, *Chem. Phys.*, **339**, 154-163 (2007)
15. Solution-phase structural characterization of supramolecular assemblies by high-angle molecular diffraction, J.L. O'Donnell, X. Zuo, A.J. Goshe, L. Sarkisov, R. Q. Snurr, J. T. Hupp, D. M. Tiede, *J. Am. Chem. Soc.*, **129**, 1578-1585 (2007)

Regulation of the Electron Transfer in Natural Photosynthesis

Oleg G. Poluektov, Principal Investigator

Lisa M. Utschig, Lin Chen, David M. Tiede, Co-PIs

Sergey Milikisiyants, Sergey Antipov, Postdoctoral Research Associates

9700 S. Cass Ave, Argonne National Laboratory (ANL), Argonne, IL 60439

Web: http://www.cmt.anl.gov/Fundamental_Interactions/Solar_Conversion.shtml

Overall research goals: Our research is focused on investigation of fundamental mechanisms for solar energy conversion in natural photosynthesis. We approach this goal by: (1) developing new experimental methods to study light-induced electron and energy transfer in photosynthetic reaction center proteins (RC); (2) resolving mechanisms that allow RCs to operate as media optimized for efficient electron transfer (ET) reactions; (3) investigate structural dynamics associated with both activationless and conformationally gated ET processes; (4) investigate the response of the protein environment to light-induced charge separation. Understanding structure-function relationships in biological photosynthesis provides the basis to design advanced, biomimetic artificial photosynthetic systems.

Significant achievements 2007-2009: Considerable progress has been made in understanding proton-coupled electron transfer reactions (PCET) in type II RCs as well as model systems. It has been shown that the protein environment is strongly involved in regulating ET dynamics on the level of hydrogen-bond network. However, the involvement of co-factor conformational dynamics in gated ET reactions has yet to be proven. Thus the nature of the gate of $Q_A^-Q_B \rightarrow Q_AQ_B^-$ reaction remains unclear. Looking at high-frequency (HF) EPR spectra of specifically trapped kinetic substates of the RC, we showed that the earlier proposed movement of Q_B from the “proximal” to the “distal” site is not a gate for interquinone ET. Can it be that Q_A is involved in the conformational gating of $Q_A^-Q_B \rightarrow Q_AQ_B^-$ ET? Using advanced time-resolved (TR) HF EPR techniques (in collaboration with G. Kothe, Freiburg University) we found that the geometry of Q_A^- , observed on a nanosecond time scale after light-induced ET to Q_A , deviates from the Q_A geometry determined by X-ray diffraction analysis. This observation suggests that the conformational state of Q_A possibly plays an important role in forward ET.

To examine possible reasons for the different Q_A geometries obtained from TR EPR vs. X-ray crystallography, we have performed a systematic study of the effects of radiation on RC crystals using HF EPR spectroscopy. Our experiments demonstrate

that radiation induces cofactor oxidation state changes that alter the native activity of the protein. We suggest that radiation induced reduction of the quinones can provide an explanation for the multiplicity of quinone binding sites observed in RC crystal structures, and for discrepancies between spectroscopic and crystallographic measurements of quinone site structures.

Science objectives for 2009-2010:

- Recently we developed a new method to probe the response of the protein environment to light-induced charge separation. The method is based on the time-resolved electron-nuclear double resonance (ENDOR) study of the spin-correlated radical pairs (SCRPs) in photosynthetic RCs at high magnetic fields. It was demonstrated that, in purple bacterial RCs, considerable matrix relaxation occurs immediately following ET. We will apply this technique to photosystem I. The challenge here is to find out if similar relaxation changes occur in type I vs. type II RCs and determine the molecular mechanism of these relaxations.

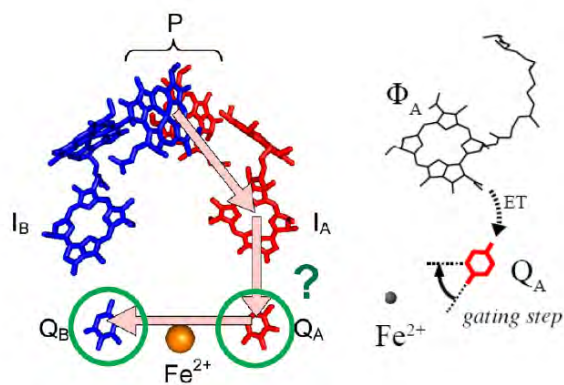

Figure 1. Left: Schematic presentation of co-factors in *R. sphaeroides*. Conformational change of Q_B is not a gate for interquinone ET. Right: Proposed gating of the $Q_A^-Q_B \rightarrow Q_AQ_B^-$ reaction.

- We will study the temperature dependence of spin-dynamics in SCRPs of purple bacterial RC and photosystem I in order to clarify if entangled states of the SCRPs contribute to the stabilization of the separated charges.
- We will continue our study of the mechanism of PCET in photosynthetic proteins and model systems. We will investigate if light-induced conformational changes that occur in purple bacterial RCs (Kleinfeld effect) are common for all types of RCs as well as in artificial photosynthetic assemblies.

References to work supported by this project 2007-2009:

1. Smirnova, T. I., Smirnov, A. I., Pachtchenko, S., and Poluektov, O. G. Geometry of Hydrogen Bonds Formed by Lipid Bilayer Nitroxide Probes: A High Frequency Pulsed ENDOR/EPR Study, *J. Am. Chem. Soc. (Communication)*, 2007, v. 129 (12), 3476-3477.
2. Smirnova, T. I., Chadwick, T. G., Voinov, M. A., Poluektov, O., van Tol, J., Ozarowski, A., Schaaf, G., Ryan, M. M., and Bankaitis, V. A. Local Polarity and Hydrogen Bonding inside Sec14p Lipid-binding Cavity: High-Field Multifrequency EPR Studies, *Biophys. J.*, 2007, v. 92 (10), 3686-3695.
3. Poluektov, O. G., Utschig, L. M., Thurnauer, M. C., and Kothe, G. Exploring Hyperfine Interactions in Spin-Correlated Radical Pairs from Photosynthetic Proteins: High-Frequency ENDOR and Quantum Beat Oscillations, *Appl. Magn. Reson.*, 2007, v. 31 (1-2), 123-143.
4. Dimitrijevic, N. M., Saponjic, Z. V., Rabatic, B. M., Poluektov, O. G., and Rajh, T. Effect of Size and Shape of Nanocrystalline TiO₂ on Photogenerated Charges. An EPR Study, *J. Phys. Chem. C Lett.*, 2007, v. 111 (40), 14597-14601.
5. Heinen, U., Utschig, L. M., Poluektov, O. G., Link, G., Ohmes, E., and Kothe, G. Structure of the Charge Separated State P⁺₈₆₅Q_A⁻ in the Photosynthetic Reaction Centers of *Rhodobacter sphaeroides* by Quantum Beat Oscillations and High-Field Electron Paramagnetic Resonance: Evidence for Light-Induced Q_A⁻ Reorientation, *J. Am. Chem. Soc.*, 2007, v. 129, 15935-15946
6. Poluektov, O., Utschig, L., Paschenko, S., Lakshmi, K., and Tiede, D. Time-Resolved High-Field EPR Spectroscopy Of Natural Photosynthesis: Photoinduced Electron Transfer Pathways In Photosystem I, *Photosyn. Res.*, 2007, v. 91 (2-3), 150-151.
7. Kothe, G., Norris, J. R., Poluektov, O. G., and Thurnauer, M. C. (2008) High-Time Resolution Electron Paramagnetic Resonance - Study of Quantum Beat Oscillations Observed in Photosynthetic Reaction Center Proteins. In: Matysik J. and Aartsma T. J., (eds) *Biophysical Techniques on Photosynthesis II*, Vol. 26 pp. 305-323, Chapter 15, Springer, Dordrecht, The Netherlands.
8. Poluektov, O. G. and Utschig, L. M. (2008) Protein Environments and Electron Transfer Processes Probed with High-Frequency ENDOR. In: Hunter CN, Daldal, F, Thurnauer MC, and Beatty JT (eds) *The Purple Phototrophic Bacteria. Advances in Photosynthesis and Respiration*, Vol. 28, pp. 155-179, Springer, Dordrecht, The Netherlands.
9. Utschig, L. M., Chen, L. X., and Poluektov, O. G. Discovery of Native Metal Ion Sites Located on the Ferredoxin Docking Side of Photosystem I, *Biochem.*, 2008, v. 47, 3671-3676.
10. Utschig, L. M., Chemerisov, S. D., Tiede, D. M., and Poluektov, O. G. Electron paramagnetic resonance study of radiation damage in photosynthetic reaction center crystals, *Biochem.*, 2008, v. 47, 9251-9257.
11. Moore, G. F., Hambourger, M., Gervaldo, M., Poluektov, O. G., Rajh, T., Gust, D., Moore, T. A., and Moore, A. L. A Bioinspired Construct That Mimics the Proton Coupled Electron Transfer between P680⁺ and the Tyr_Z-His190 Pair of Photosystem II, *J. Am. Chem. Soc.*, 2008, v. 130, 10466-10467.
12. Pavel G. Baranov, P. G., Romanov, N. G., and Poluektov O. G. Self-Trapped Excitons in Ionic-Covalent Silver-Halide Crystals and Nanostructures. In: V. S. Vixhnin and G. Liu (eds) *Charge Transfer and Vibronic States in Ionic-Covalent Systems: Theory, Experiment, and Applications*, 2009, Springer, in press.
13. L. M. Utschig, S. D. Dalosto, M. C. Thurnauer, and O. G. Poluektov, "The Surface Metal Site in *Blc. Viridis* Photosynthetic Bacterial Reaction Centers: Cu²⁺ as a Probe of Structure, Location, and Flexibility" *Appl. Magn. Reson.* 2009, submitted
14. O. G. Poluektov, S. V. Paschenko, and L. M. Utschig, "Spin-Dynamics of the Spin-Correlated Radical Pair in Photosystem I. Pulsed Time-Resolved EPR at High Magnetic Field." *Phys. Chem. Chem. Phys.* 2009, submitted.

Antisense RNAs in the Chloroplast

David B. Stern, Principal Investigator

Amber Hotto and Robert Sharwood, Postdoctoral Associates

Boyce Thompson Institute for Plant Research, Ithaca, NY 14853

Email: ds28@cornell.edu

Overall research goals: Our project aims to ascertain gene regulatory roles for chloroplast antisense RNAs (asRNAs), an RNA class which is virtually unstudied in organelles. Our preliminary data showed that an asRNA called AS5 overaccumulated in an *Arabidopsis* nuclear mutant deficient in a chloroplast ribonuclease and 5S rRNA. We hypothesized that AS5 targets 5S rRNA for degradation in this mutant. Three experimental goals were proposed: (1) to understand how AS5 controls 5S rRNA stability, using a combination of *in vitro* biochemistry and transgenic over- or underexpression of AS5; (2) to explore roles of two potential chloroplast ribonuclease III (RNC) homologs in catalyzing AS5-mediated 5S turnover; and (3) to identify the full complement of chloroplast-encoded asRNAs, and to begin to understand the diversity of their biological functions, which are hypothesized to include regulation of transcription, translation and intron splicing.

Significant achievements 2007-2009: We have established a robust *in vitro* system for testing roles of asRNAs in chloroplast RNA processing, and shown that AS5 can inhibit 5S rRNA maturation in this context (Fig. 1). We have also succeeded in overexpressing AS5 using chloroplast transformation, and found an effect on tRNA but not rRNA maturation. We have found that both RNC proteins are likely chloroplast-targeted, and reverse genetic studies are in progress. Finally, we found that plants deficient in another chloroplast ribonuclease, polynucleotide phosphorylase, hyperaccumulate asRNAs (Fig. 2), thus providing an excellent experimental platform for asRNA discovery.

Science objectives for 2009-2010:

- *In vitro* assays will be completed, demonstrating which portions of AS5 are able to compromise 5S rRNA processing. This should help to establish some principles regarding the possible roles of asRNAs *in vivo*.
- Determine growth phenotypes of RNC single and double

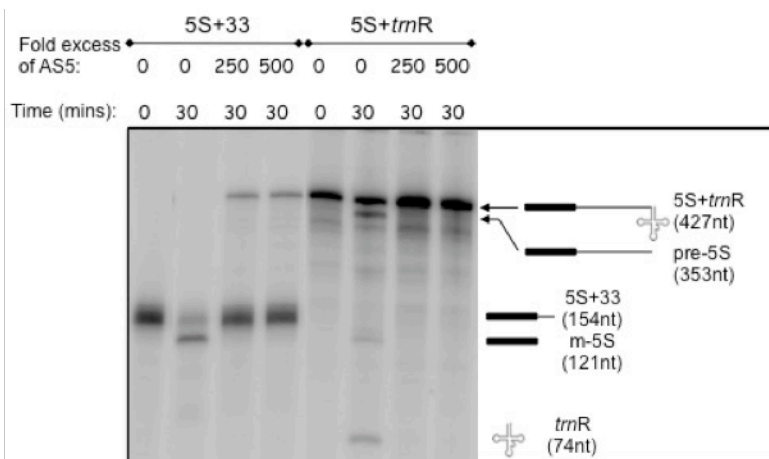

Fig. 1. AS5 function *in vitro*. Spinach chloroplast protein extract (4.5 mg/mL) was incubated with 2 fmol of 5S-*trnR* and 5S+33 substrates in the presence of AS5 in a 0 – 500 fold excess.

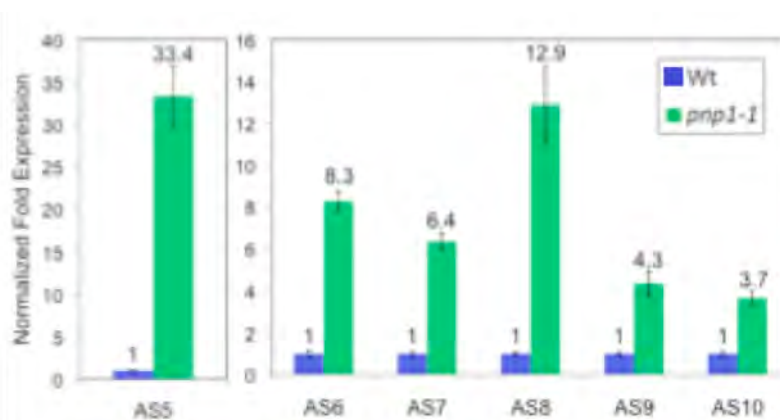

Fig. 2. asRNA accumulation in the *pnp1-1* mutant. qRT-PCR was used to compare levels of six chloroplast asRNAs in the WT (blue) and mutant (green). The WT level was set to 1 by normalizing to a nuclear reference gene.

mutants, and explore chloroplast RNA metabolism in these mutants, to ascertain the roles of these RNase III-like proteins which have been previously unstudied.

- Complete the analysis of tobacco chloroplast transformants overexpressing AS5, mentioned above, as well as plants overexpressing another asRNA, AS9, which have already been produced.
- Use the *pnp* mutant (Fig. 2) as a platform for extensive RNA analysis to complete the inventory of asRNAs, using a comparison to WT plants for verification.

References to work supported by this project 2007-2009:

1. Bollenbach TJ, Sharwood RE, Gutierrez R, Lerbs-Mache S, Stern DB (2009). The RNA-binding proteins CSP41a and CSP41b may regulate transcription and translation of chloroplast-encoded RNAs in Arabidopsis. *Plant Mol. Biol.* 69:541.
2. Bollenbach, T., Schuster, G., Portnoy V, and Stern, D.B. (2008). Processing, degradation and polyadenylation of chloroplast transcripts. *Topics Curr. Genet.* 19:175-211.
3. Schuster G, Stern D (2009). RNA polyadenylation and decay in mitochondria and chloroplasts. *Prog. Mol. Biol. Transl. Sci.*, 85:393-422.

Characterization of Photosynthetic Proteins by Solid State NMR Spectroscopy

Ann McDermott, Principal Investigator

Paul Harvilla, Co-PI

Columbia University Department of Chemistry MC 3113, 3000 Broadway, NY NY 10027

Email: aem5@columbia.edu; Web: <http://mcdermott.chem.columbia.edu>

Overall research goals: The research objectives are to characterize the light harvesting and reaction center proteins of *R. Sphaeroides*. The structure, the plasticity and heterogeneity are expected to be important for optimal exciton lifetime and transfer efficiencies.

Preliminary achievements: Extensive NMR spectral assignments have been determined in my laboratory for LHC1, and assignments for LHC2 are available from the laboratory of H. deGroot. Analysis of chemical shifts indicates specialized environments and plasticity at key BChl exocyclic positions.

Objectives for 2009-2010:

- Complete the spectral assignments for LH1. This will set the stage for structural and conformational dynamics work on the proteins and cofactors.
- Analyze the chemical shifts in a molecularly detailed sense, using *ab initio* and informatics based methods, focusing particularly on hydrogen bonding and strained torsions in the macrocycles.
- Investigate whether our previously reported CIDNP effects or dynamics nuclear polarization can be used to enhance the signals.
- Contrast the chemical shifts recorded in crystalline reconstituted samples to those from in native membranes. Contrast shifts with and without RC present, with and without puf X present.

Related References

1. McDermott A. (2009) Structure and dynamics of membrane proteins by magic angle spinning solid-state NMR
Annu. Rev. Biophys. 38, 385-403C.
2. Huang L. and McDermott A.E. (2008) Partial site-specific assignment of a uniformly ¹³C, ¹⁵N enriched membrane protein, light-harvesting complex 1 (LH1), by solid state NMR. *Biochim. Biophys. Acta.* 1777(9), 1098-108
3. Lorieau J., McDermott, A.E. (2006) Order parameters based on ¹³C1H, ¹³C1H2 and ¹³C1H3 heteronuclear dipolar powder patterns: a comparison of MAS-based solid-state NMR sequences. *Magn. Reson. Chem.* 44, 334-347.
4. Li W., McDermott A.E. (2009) Characterization of slow conformational dynamics in solids: dipolar CODEX
J. Biomol. NMR. 45(1-2), 227-232
5. Zysmilich, Martín & McDermott, Ann E. (1996) [Photochemically Induced Nuclear Spin Polarization in Bacterial Photosynthetic Reaction Centers: Assignments of the Chemical Shifts](#), *Journal of the American Chemical Society*, 118, 5867-5873.

New Insight into the Electronic Structure of the CP47 Antenna Protein Complex of Photosystem II: Hole-Burning Study and Simulation of Optical Spectra

Ryszard Jankowiak, Principal Investigator; E-mail: ryszard@ksu.edu

Collaborators: M. Seibert, NREL, Golden, CO and M. Wasielewski, Northwestern University, Evanston, IL.

Overall research goals: The research objectives are to better understand the performance of solar conversion systems including natural and artificial systems. Hole-burning (HB) and single photosynthetic complex spectroscopy are used to study the excitonic structure and excitation energy transfer (EET) processes as they occur in various photosynthetic complexes (including reaction centers (RC)), and different chlorophyll (Chl) trefoils. It is anticipated that experimentally determined parameters will allow for better modelling of excitonic structure and EET dynamics at a quantitative level. Chl trefoils are of great interest as they show rapid EET, and form self-assembling aggregates.

Significant achievements 2008-2009: We have shown that the electronic structure of the CP43 of PSII can be explained via the model of uncorrelated EET between the two low-energy quasi-degenerate bands [1,2]. The model was applied to fit simultaneously various optical spectra providing strong evidence for the existence of efficient EET between the two lowest energy states *A* and *B* in CP43 [1,2]. Possible candidate Chls for the low-energy *A* and *B* states were proposed, providing a link between CP43 structure and spectroscopy [2]. It was also shown that persistent holes originate from regular non-photochemical HB [2], rather than photoconversion involving Chl-protein hydrogen bonding as suggested before [J.L. Hughes *et al.*, *Biochemistry* 45, 12345, 2006].

Very recently, we have shown that low temperature fluorescence maximum of CP47 antenna protein complex of PSII is near 695 nm and not, as previously reported, at 690-692 nm. The latter emission peak consists of three distinct bands: a lowest-state emission band near 695 nm (F1) originating from the lowest-energy excitonic state A1 of intact complexes (near 693 nm) as well as emission peaks near 690 nm (FT1) and 685 nm (FT2) originating from subpopulations of partly destabilized complexes. The observation of the F1 emission is in excellent agreement with the 695 nm emission observed in the intact PSII cores and in thylakoid membranes. Varying contributions from the F1, FT1, and FT2 emission bands led to different maxima of fluorescence spectra reported in the literature [3]. The fluorescence spectra were consistent with the zero-phonon hole action spectra, the profiles of the non-resonantly burned holes as a function of fluence, as well as the fluorescence line-narrowed spectra obtained for the Q_y -band. The fits to the experimental absorption, fluorescence, and HB spectra for CP47 complex are shown in Figure 1 [4].

Figure 1. Fits (dashed curves) to the experimental 5 K absorption, emission, and non-resonant hole burned spectrum of CP47 complex (solid curves). Calculated spectra were obtained for the best combination of Chls contributing to the lowest energy state near 693 nm. In the fit shown, the lowest state resides mainly on Chl 523 while Chl 526 contributes strongly to the second lowest state.

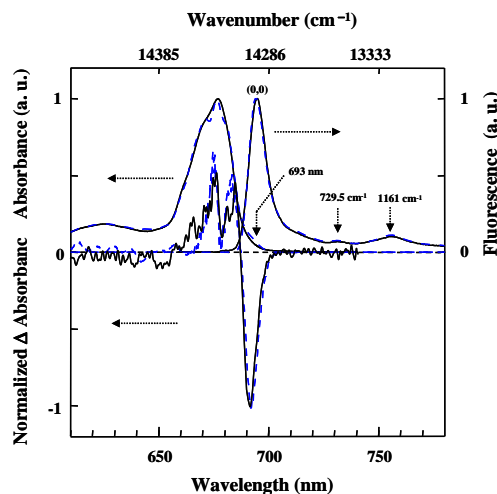

Our findings provided important constraints/parameters for excitonic calculations, which in turn offered new insight into the excitonic structure and composition of low-energy states [4]. Using Monte Carlo simulations we have shown that the lowest-energy state is *not* localized exclusively on Chl 526 as previously suggested [Raszewski and Renger, *J. Am. Chem. Soc.* 2008, 130, 4431], although this pigment partially contributes. Instead Chl 523 provides a large contribution to the lowest state near 693 nm. Since the fits of non-resonant holes are more restrictive (in terms of possible site energies) than those of absorption and emission spectra, we suggest that fits that include HB spectra provide more realistic Chl site energies [4].

Science objectives for 2009-2010:

- **Single-site parameters.** A challenge in spectroscopic applications to photosynthetic complexes is to obtain detailed information on the “single-site” spectral profile, i.e. the absorption or emission spectrum of individual molecules. In measured bulk spectra, the single-site spectrum (SSS) is obscured by convolution with a distribution function, which results from differences in the micro environments of individual molecules in a sample. We will investigate the feasibility of using numerical Fourier transform deconvolution methods to obtain the SSS from bulk absorption and emission spectra and the distribution function. We will also explore an alternative approach which we believe will be less susceptible to noise in the experimental data. The method will rely on matching the low-frequency region of the distribution function to the absorption spectrum. It is anticipated that the Franck-Condon factor α (a crucial parameter in the SSS) can be approximated by the ratio of the total area under the scaled distribution function to the area under the absorption spectrum.
- **Chlamy PSI-LHCI and PSI complexes.** Study to what degree the disruption of specific interactions of the PSI core and LHCI is responsible for the observed changes in the red edge of the PSI Q_y absorption region.
- **Chl trefoil arrays.** We will continue studies of Chl trefoil arrays. These arrays are of great interest, since they represent linked donor-bridge-acceptor molecular systems in which efficient, nearly distance-independent, photo-induced charge separation occurs. We will use high resolution spectroscopies to provide more insight into the electronic structure of these systems as such data could assist in the optimization of molecular geometries for use in artificial solar cells.
- **Non-resonant HB spectra.** We will describe fluence dependent non-resonant HB spectra of various excitonically coupled systems. We anticipate that better understanding of HB spectra obtained for various photosynthetic complexes and their simultaneous fits with other optical spectra will provide more insight into the underlying electronic structure and dynamics of these complex biological systems.

References to work supported by this project 2008-2009:

1. N.C. Dang, V. Zazubovich, M. Reppert, B. Neupane, R. Picorel, M. Seibert, and R. Jankowiak, *J. Phys. Chem.* **112**, 9921-9933, 2008
2. M. Reppert, N.C. Dang, V. Zazubovich, M. Seibert, and R. Jankowiak, *J. Phys. Chem.* **112**, 9934-9947, 2008.
3. B. Neupane, N. Dang, M. Reppert, K. Acharya, V. Zazubovich, R. Picorel, M. Seibert, and R. Jankowiak, *J. Phys. Chem. B* 2009, submitted.
4. M. Reppert, K. Acharya, B. Neupane, and R. Jankowiak, *J. Phys. Chem. B* 2009, submitted.

Identification of Protein – Chloride Interactions in Photosystem II

Terry M. Bricker, Principal Investigator

Laurie K. Frankel, Co-PI

David Longstreth, Faculty Collaborator

Shulu Zhang and Johnna Roose, Postdoctoral Research Associates

Haijun Liu, Graduate Student

Lance Middleton, Camille Graham, Nathali Malcolm, Kevin Spann, Undergraduate Researchers

Department of Biological Sciences, Louisiana State University, Baton Rouge, LA 70803

Email: btbric@lsu.edu

Overall research goals: The research goals are: (1) to examine the interplay of the PsbO, PsbP, and PsbQ proteins in the modulation of the chloride (and calcium) requirement for Photosystem II (PS II) activity, (2) determine the roles played by putative chloride transporters and a putative chloride exporter in optimizing photoautotrophy, (3) the identification of novel genes involved in chloride homeostasis, and (4) “Deep Sequencing” transcript analysis of the *Synechocystis* 6803 transcriptome upon adaptation to both low and high chloride growth conditions.

Significant achievements 2008-2009:

- The PsbO protein was determined to play a critical role in calcium utilization by PS II. Additional results indicated that calcium and chloride act in concert to maintain optimal oxygen evolving activity. The PsbP protein, known to be involved in calcium and chloride sequestration by PS II, was shown to also modulate chloroplast thylakoid architecture. Finally, removal of the PsbP and PsbQ proteins by salt-washing was shown unexpectedly to dramatically alter electron transfer on the reducing-side of PS II.
- A semi-high throughput screen of an *in vitro* transposon mutagenesis experiment in *Synechocystis* 6803 has been performed (Shulu Zhang). Approximately 5000 insertion mutants have been screened for the loss of the ability to grow photoautotrophically under both low chloride (20 μM) and high chloride (600 mM) conditions (in collaboration with Dr. David Longstreth). 17 mutants have been identified which cannot grow efficiently under chloride-limiting conditions while 8 mutants have been identified which cannot grow efficiently in high chloride environments.
- The transposon insertion site of one of the low chloride growth mutants, 1D2 (see Fig. 1), has been mapped to the *slr0551* gene (Shulu Zhang), which encodes a hypothetical protein. Interestingly, this gene has strong homology to the Arabidopsis At5g63420 locus. T-DNA lines which bear insertions in this gene are embryonic lethals and the encoded protein has been shown to be a chloroplast stroma component.

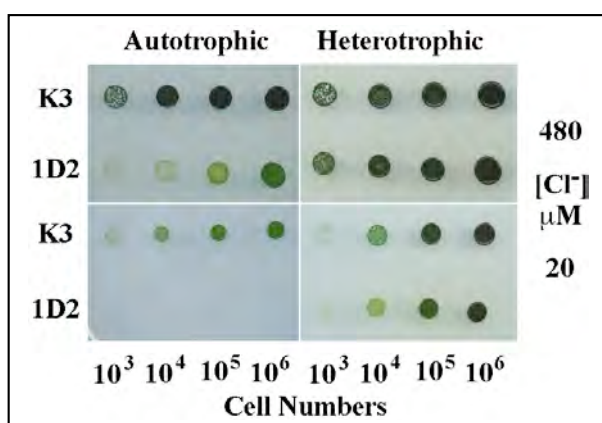

Figure 1. Growth of the Control Strain K3 and the Mutant 1D2 under both Autotrophic and Heterotrophic Conditions at Normal (480 μM) and Low (20 μM) Chloride Concentrations.

- The genes encoding three putative chloride transporter genes (*sll0855*, *sll1864* and *slr0617*) and a putative chloride exporter (*slr0753*) have been deleted by site-directed mutagenesis (Johnna Roose). RT-PCR indicates that all four genes are expressed at low levels under both low (20 μ M) and normal (480 μ M) chloride conditions (Lance Middleton). Steady state oxygen evolution rates indicate that the Δ slr0617 mutant evolves oxygen at a rate of 65-80% of wild type. Interestingly, the Δ slr0753 mutant evolves oxygen at 120-140% of wild type rates (Camille Graham). We hypothesize that these two genes may act in a complementary manner to regulate internal chloride concentrations. All possible double deletion strains have also been produced. Finally, a His₆-tagged version of the *slr0617* gene has been produced and complements the Δ slr0617 mutant phenotype. This should prove useful in identifying the subcellular location of the Slr0617 protein.

Science objectives for 2009-2010:

- Identify the transposon insertion sites in the mutants exhibiting altered chloride requirements.
- Determine if the embryonic lethal phenotype observed in the At5g63420 mutants can be chemically complemented with glucose and/or high chloride.
- Examine the chloride requirement in the double chloride transporter mutants and determine the subcellular location of the Slr0617 protein.
- Perform preliminary transcript analysis using both the Roche 454 Sequencer and an ABI Solid sequencer (we have access to both instruments).

References to work supported by this project 2008-2009:

1. Roose, J.R., Frankel, L.K., and Bricker, T.M. "Documentation of Significant Electron Transport Defects on the Reducing Side of Photosystem II upon Removal of the PsbP and PsbQ Extrinsic Proteins" Submitted *Biochemistry*.
2. Liu, H., Frankel, L.K., and Bricker, T.M., "Characterization and Complementation of a *psbR* Mutant in *Arabidopsis thaliana*" In press, *Archives of Biochemistry and Biophysics* DOI:10.1016/j.abb.2009.07.014.
3. Liu, H., Frankel, L.K. and Bricker, T.M. "Functional Complementation of the *psbo1* Mutant with a His₆-Tagged PsbO-1 Protein in Photosystem II of *Arabidopsis*" *Biochimica et Biophysica Acta*. 1787,1029-1038 (2009).
4. Yi, X., Hargett, S.R., Frankel, L.K. and Bricker, T.M. "The PsbP Protein, but not the PsbQ Protein, Is Required for Normal Thylakoid Architecture In *Arabidopsis thaliana*" *FEBS Letters* 583,2142-2147 (2009).
5. Zhang, S., Spann, K.W., Moroney, J.V. Frankel, L.K. and Bricker, T.M., "The Involvement of Two Novel Genes, *sll0804* and *slr1306*, in the CO₂-concentrating Mechanism in the Cyanobacterium *Synechocystis* sp. strain PCC 6803" *Journal of Bacteriology* 190,8234-8237 (2008).
6. Yi, X., Hargett, S.R., Frankel, L.K. and Bricker, T.M., "The Effects of Simultaneous RNAi Suppression of PsbO and PsbP Protein Expression in Photosystem II of *Arabidopsis*" *Photosynthesis Research* 98,439-448 (2008).
7. Bricker, T.M. and Frankel, L.K., "The *Arabidopsis psbo1* Mutant Cannot Efficiently Utilize Calcium in Support of Photosynthetic Oxygen Evolution" *Journal of Biological Chemistry* 283,29022-29027 (2008).

Structural, Functional, and Integration Studies of Solar-Driven, Bio-Hybrid, H₂-Producing Systems

Maria L. Ghirardi, Principal Investigator

P. W. King, K. Kim, and C. Chang, NREL; D. Gust, A. L. Moore and T. A. Moore, Arizona State University, Tempe, AZ; M. J. Heben, University of Toledo; Co-Principal Investigators National Renewable Energy Laboratory (NREL), 1617 Cole Boulevard, Golden, CO 80401
Email: maria.ghirardi@nrel.gov

Collaborators: Dr. N.J. Tao, Arizona State University, Tempe, AZ USA
Dr. T. Furtak, Colorado School of Mines, Golden, CO USA

Overall research objectives: The overall goal of the project is to develop an understanding of [FeFe] hydrogenase (H₂ase) structure-function, H₂ase integration in a photoelectrochemical (PEC) cell, and the parameters that control PEC hydrogen production efficiencies. Areas of research include: (i) developing theoretical models of H₂ase iron-sulfur clusters and proton-transfer pathways; (ii) experimental studies of H₂ase using mutagenesis and infra-red spectroscopy; (iii) optical and electronic studies of H₂ase-carbon nanotube and nanocrystal complexes; and (iv) understanding H₂ase interactions with electrode surfaces. These efforts will provide fundamental knowledge of H₂ production catalysts; and how to functionally integrate them in PEC hydrogen production schemes.

Significant achievements 2008-2009: (i) Density functional theory (DFT) was used to derive molecular mechanical (MM) models for oxidized and reduced states of the auxiliary [FeS] and H-clusters of H₂ase. Quasiharmonic vibrational analysis of molecular dynamics (MD) trajectories suggested a role for the protein structure in the dynamics of cluster motion. QM-MM and adiabatic mapping method was also used to map the energy profile along the proton transfer pathway in H₂ase. (ii) Raman spectroscopy of the time-dependent changes in H₂ase-single-walled nanotube (H₂ase-SWNT) hybrids revealed charge-transfer from oxidized H₂ase to metallic SWNTs under an argon atmosphere. A hypothesis for this process is that the metallic SWNTs, by virtue of their continuous density of states, further oxidize the H₂ase to a higher oxidation state, which is also less sensitive to oxygen. (iii) The H₂ase has been successfully adsorbed to bare Au electrodes and retains activity. Mutagenesis was used to suggest that the binding mode involves surface exposed cysteine(s), with the H₂ases oriented lengthwise on the Au surface. Single-molecule STM images have been obtained and suggest tunneling currents increase under an applied bias. Removal of adsorbed H₂ase from the STM surface helped confirm that the features observed with the STM are H₂ase. (iv) H₂ase and mercaptopropionic acid (MPA) capped CdTe nanocrystals form stable hybrid complexes. When illuminated, these evolve hydrogen in the presence of a sacrificial donor.

Science objectives for 2009-2010:

- The calculated DFT parameters for H₂ase [FeS] clusters will be used to investigate the electron-transfer processes through a combination of MD and QM-MM studies. The energy profile along the proton transfer pathway will be further refined by umbrella sampling method. The binding structure of H₂ase and SWNT will be investigated using Brownian dynamic and molecular dynamic method.
- We will characterize the IR spectra of native and mutant H₂ases to determine whether variations in catalytic site protein environments alter the diatomic ligand conformation of the catalytic H-cluster under potential induced redox states.

- Single-molecule electrochemistry of immobilized H₂ase on Au-electrodes will continue to be developed to characterize the binding interaction, tunneling currents and the operating potentials of the enzyme.
- We will elucidate the charge-transfer mechanisms between H₂ase and SWNT's in solution complexes under photoexcitation using time-resolved optical techniques.

References to work supported by this project 2007-2009:

1. Cohen, J., and Schulten, K. **2007**. O₂ migration pathways are not conserved across proteins of a similar fold. *Biophys. J.* **93**:3591-600.
2. McDonald, T.J., Svedruzic, D., Kim, Y-H., Blackburn, J.L., Zhang, S. B., King P.W., and Heben, M.J. **2007**. "Wiring up hydrogenase with single-walled carbon nanotubes." *NanoLetts.* **7**:3528-34.
3. Hambourger, M., Gervaldo, M., Svedruzic, D., King, P.W., Gust, D., Ghirardi, M., Moore, A.L. and Moore, T.A. **2008**. "[FeFe]-Hydrogenase-catalyzed H₂ production in a photoelectrochemical biofuel cell." *JACS.* **130**(6):2015-22.
4. Blackburn, J.L., Svedruzic, D., McDonald, T.J., Kim, Y-H., King P.W. and M.J. Heben. **2008**. Raman spectroscopy of charge transfer interactions between single wall carbon nanotubes and [FeFe] hydrogenase. *Dalton Trans.* **40**:5454-61.
5. Cohen, J., Olsen, K.W., and Schulten, K. **2008**. "Finding gas migration pathways in proteins using implicit ligand sampling." *Meth. Enzymol.* **437**:439-457.
6. Gust, D., Kramer, D., Moore, A., Moore, T.A., and Vermaas, W. **2008**. "Engineered and artificial photosynthesis: human ingenuity enters the game." *MRS Bull.* **33**:383-387.
7. Hambourger, M., Moore, G.F., Kramer, D.M., Gust, D., Moore, A.L., and Moore, T.A. **2009**. "Biology and technology for photochemical fuel production." *Chem. Soc. Rev.* **38**:25-35.
8. Chang, C.H., and Kim, K. **2009**. Density functional theory calculation of bonding and charge parameters for molecular dynamics studies on [FeFe] Hydrogenases. *J. Chem. Theory Comput.* **5**(4):1137-45.

Protein Targeting to the Thylakoid Membrane

Kenneth Keegstra, Principal Investigator

John E Froehlich, Co-PI

MSU-DOE Plant Research Laboratory, Michigan State University, East Lansing, MI 48823

Email: keegstra@cns.msu.edu; Web: <http://www.prl.msu.edu/>

Overall research goals: The major focus of our current research is to understand how hydrophobic thylakoid membrane proteins get past the inner envelope membrane while other similarly hydrophobic proteins are halted at the inner envelope membrane. Our specific objectives are: (1) to identify features of a stop-transfer transmembrane domains (TMDs) that halt proteins at the Inner Envelope Membrane (IEM); (2) to identify features within the TMDs of thylakoid membrane proteins that allows these proteins to cross the IEM; and (3) to identify targeting features of selected imported proteins that directs them to the IEM via the Conservative Sorting Pathway.

Background: Chloroplasts are unique among eukaryotic organelles in that they have three distinct membranes. This poses an interesting targeting problem for hydrophobic thylakoid membrane proteins that nuclear encoded in that they must cross the two envelope membranes before being inserted into the third membrane they encounter. Targeting to the IEM is also complicated in that proteins destined for this location are proposed to follow two different pathways; one is the stop-transfer route and the other is the conservative sorting pathway (Fig. 1; Li and Schnell, 2006; Tripp et al., 2007). Because the thylakoid membranes contain the four major photosynthetic complexes: photosystem I (PSI), photosystem II (PSII), the cytochrome b6f complex, and the ATP synthase complex (see Fig 1), understanding the targeting of the ~30 nuclear encoded proteins present in these complexes is an important issue.

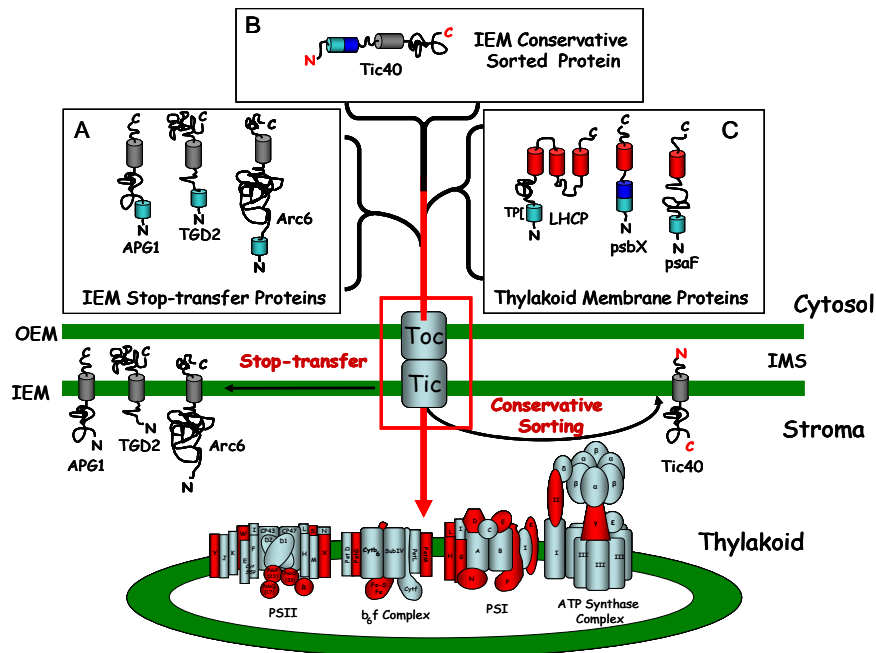

Fig. 1. Comparison of membrane proteins that are inserted into the IEM via either the stop-transfer pathway (Group A) or conservative sorting pathway (Group B) versus integral thylakoid membrane proteins (Group C) that must first traverse the IEM (red arrow) and then insert themselves into the thylakoid membrane. Consequently, integral thylakoid membrane proteins have a significant dilemma: How do they cross the envelope membrane enroute to their final destination the thylakoid membrane? Nuclear-encoded (Red Proteins) and chloroplastic-encoded (Light blue) components of the different photosynthetic complexes are shown within the thylakoid membrane.

We have examined the sorting mechanism involved in the proper targeting of known integral thylakoid and inner envelope membrane proteins. Using different model proteins that are known to reside in the thylakoid membrane or in the IEM and standard molecular biology techniques, we have attempted to identify essential targeting determinants that cause these proteins to either be halted at the inner envelope membrane or to be transported across it, where subsequent targeting events can direct these proteins to the thylakoid membrane. We anticipate that the information gained from our comparative analysis will result in the identification of unique differences between the TMDs of thylakoidal membrane proteins and the TMDs of IEM proteins.

Significant achievements in 2008-2009:

- Identified a Serine/Proline-rich domain within Tic40 that was essential for targeting this protein to the inner envelope (Tripp et al., 2007).
- Confirmed that the TMD of Arc6 is required to retain this protein at the inner envelope via the stop-transfer pathway (compare with Vitha et al., 2003).
- Inserted a proline residue into the TMD of Arc6 and demonstrated that it passed through the IEM. However, this strategy does not always work in changing the targeting pattern of other IEM proteins, so a central proline residue is not the only determinant.
- Developed methods to perform TMD swapping followed by import assays that will allow us to identify unique differences between the TMDs of thylakoidal membrane proteins and the those of IEM proteins.

Science objectives for 2010-2011:

- Using a combination of import assays and hybrid proteins, in which the TMD has been switched between IEM and thylakoid proteins, we will attempt to identify targeting features that determine whether or not a protein is retained at the IEM.
- Using a combination of site-directed mutagenesis and import assays, evaluate the role of other features postulated to be determinants of retention within the IEM. For example, large residues such as phenylalanine or tryptophan are often found near the C-terminus of TMDs that act as stop-transfer signals. We will change these residues and determine the impact on targeting.
- Using a combination of site-directed mutagenesis and import assays, evaluate the role of other features postulated to be determinants allowing passage through the IEM. For example, the TMDs of thylakoid membrane proteins often have small residues such as glycine, valine or alanine. We will change these residues and determine the impact on targeting.

References:

1. M Li and DJ Schnell, "Reconstitution of protein targeting to the inner envelope membrane of chloroplasts. *J Cell Biol.* **175**: 249-259 (2006).
2. J Tripp, K Inoue, K Keegstra, JE Froehlich, "A novel serine/proline-rich domain in combination with a transmembrane domain is required for the insertion of AtTic40 into the inner envelope membrane of chloroplasts." *Plant J* **52**: 824-838 (2007).
3. S Vitha, JE Froehlich, O Koksharova, KA Pyke, H van Erp , KW Osteryoung, " ARC6 is a J-domain plastid division protein and an evolutionary descendant of the cyanobacterial cell division protein Ftn2." *Plant Cell* **15**: 1918-1933 (2003).

Triplet excitons: a novel photoprotection mechanism in strongly coupled photosynthetic complexes

Sergei Savikhin¹, Principal Investigator

Hanyoup Kim¹, Daniel Hartzler¹, Donald A. Bryant², Hui Li², Julia A. Maresca², Co-authors

¹Purdue University, West Lafayette, IN 27907

²The Pennsylvania State University, University Park, PA 16802

Email: sergei@purdue.edu Web <http://www.physics.purdue.edu/people/faculty/sergei.shtml>

Overall research goals: The research objective is to study the novel photoprotection mechanism of light absorbing pigments discovered recently in photosynthetic complexes and its possible application for biomimetic light harvesting devices. The project started in fall 2009 and only the results of preliminary research are presented.

Background and preliminary results: (Bacterio)chlorophylls, the main light harvesting pigments of photosynthesis, are known to produce highly toxic singlet oxygen (¹O₂) as the result of energy transfer from their excited triplet state to the oxygen molecule [1]. To prevent singlet oxygen generation in light harvesting pigment-proteins of photosynthesis, a carotenoid is typically positioned within a distance of ~ 4 Å of individual chlorophylls of antenna arrays, allowing rapid triplet energy transfer from (B)Chl to the carotenoid [2-4]. The necessity of using carotenoids for photoprotection complicates engineering of stable biomimetic devices.

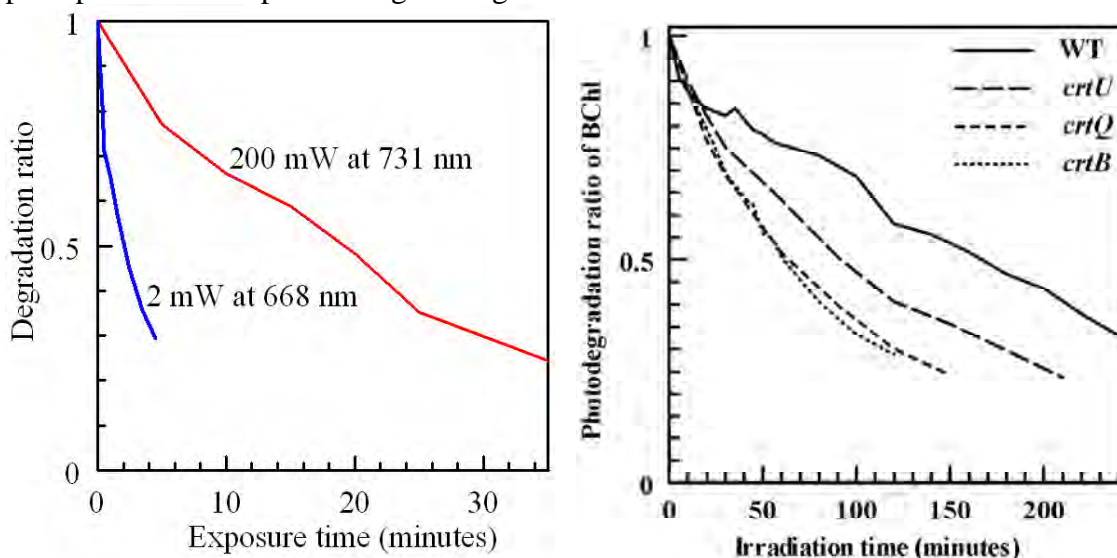

Figure 1. Left: Photodegradation rate of artificial BChl complexes (upper curve) and monomeric BChl under laser light exposure (lower curve). Notice 100 times different laser power. Right: Photodegradation rate of carotenoid free mutants (*crtU*) of chlorosomes is only ~3 times faster than that of wild type (WT), suggesting the presence of unconventional photoprotection mechanism, since monomeric BChl would photodegrade in ~5 seconds under similar irradiation level.

Our preliminary research revealed that, surprisingly, this photoprotection mechanism plays only a limited role in chlorosomes, which are the largest known light harvesting complexes developed by green sulfur bacteria that allow them to survive under extremely low light condition – absorption of only one photon by a bacteriochlorophyll (BChl) molecule in 8 hours is sufficient for survival [5, 6]. A single chlorosomal antenna complex is comprised of up to ~200,000 BChl molecules arranged into a quasi regular lattice embedded into a lipid layer. In addition, chlorosomes contain up to ~20,000 quinones, ~2000 Chl *a*, and ~20,000 carotenoid molecules. The latter were proposed to serve a photoprotective and/or light harvesting role [7]. However, the experiments on native and carotenoid-free mutants show that in chlorosomes carotenoids offer only ~3 fold photoprotection and that BChl pigments in chlorosomes are protected ~1000 times via an unconventional

mechanism that does not require carotenoids (Figure 1, left). We propose that the triplet excited state energy of BChl *c* in chlorosomes is lowered below that of oxygen due to significant triplet-triplet coupling between the closely spaced pigments, leading to the formation of a triplet exciton. The energy transfer to oxygen in this case would be blocked, and thus the formation of triplet excitons in closely coupled antenna systems may serve as an alternative and very effective photoprotection mechanism. This scenario is supported by our structure-based exciton calculations that predict that triplet exciton energy of BChl in this complex is ~0.89 eV, i.e. 0.4 eV lower than 1.29 eV measured for monomeric triplet state of BChl *c* [1]. The calculated triplet exciton energy is substantially lower than 0.97 eV reported for singlet oxygen [8]. Similar photoprotection levels were observed for artificial BChl *c* aggregates (Figure 2) synthesized by my group using method described in [9], and may be realized in other natural strongly coupled antennae such as Fenna-Matthews-Olson complex that lacks any carotenoids. Possible existence and functional role of triplet excitons in photosynthetic proteins has not been reported nor studied before and current studies may open a new avenue in engineering of photostable light harvesting antennae for biomimetic sunlight energy conversion devices.

References

1. Krasnovsky, A.A., Jr., P. Cheng, R.E. Blankenship, T.A. Moore, and D. Gust, The photophysics of monomeric bacteriochlorophylls *c* and *d* and their derivatives: properties of the triplet state and singlet oxygen photogeneration and quenching. *Photochem. Photobiol.*, 1993. **57**: p. 324-330.
2. Siefermann-Harms, D., *The light-harvesting and protective functions of carotenoids in photosynthetic membranes*. *Physiol. Plantarum.*, 1987. **69**: p. 561-568.
3. Renger, G., *Energy transfer and trapping in photosystem II*, in *Topics in photosynthesis, the photosystems: structure, function and molecular biology*, J. Barber, Editor. 1992, Elsevier: Amsterdam. p. 45-99.
4. van Grondelle, R.J., J.P. Dekker, T. Gillbro, and V. Sundstrom, *Energy trapping and transfer in photosynthesis*. *Biochim. Biophys. Acta*, 1994. **1187**: p. 1-65.
5. Blankenship, R.E. and K. Matsuura, *Antenna Complexes from green photosynthetic bacteria*, in *Light-Harvesting Antennas in Photosynthesis*, B.R. Green and W.W. Parson, Editors. 2003, Kluwer Academic Publishers: Dordrecht.
6. Frigaard, N.U. and D.A. Bryant, *Chlorosomes: antenna organelles in green photosynthetic bacteria*. In *Complex intracellular structures in prokaryotes*, in *Complex intracellular structures in prokaryotes*, J.M. Shively, Editor. 2006, Springer: Berlin. p. 79-114.
7. Psencik, J., T.J. Schaafsma, G.F.W. Searle, and J. Hala, *Fluorescence detected magnetic resonance of monomers and aggregates of bacteriochlorophylls of green sulfur bacteria Chlorobium sp.* *Photosynth. Res.*, 1997. **52**: p. 83-92.
8. Marston, G., T.G. Truscott, and R.P. Wayne, *Phosphorescence of β -carotene*. *J. Chem. Soc. Faraday Trans.*, 1995. **91**: p. 4059-4061.
9. Miller, M., T. Gillbro, and J.M. Olson, *Aqueous aggregates of bacteriochlorophyll *c* as a model for pigment organization in chlorosomes*. *Photochem. Photobiol.*, 1993. **57**: p. 98-102.

Ferredoxin-Dependent Plant Metabolic Pathways

David B. Knaff, Principal Investigator

Masakazu Hirasawa, Senior Research Scientist; Jung-Sung Chung, Postdoctoral Research Associate

Department of Chemistry and Biochemistry, Texas Tech University

Lubbock, Texas 79409-1061

Email: david.knaff@ttu.edu

Overall Research Goals: To study the mechanisms of ferredoxin-dependent enzymes in oxygenic phototrophs and map the interactions between ferredoxin and its target enzymes.

Significant Achievements in 2007-2009:

During oxygenic photosynthesis, carbon metabolism is regulated by a signaling pathway in which the presence of light is transmitted via a redox chain comprising ferredoxin (Fd), ferredoxin:thioredoxin reductase (FTR), and thioredoxin (Trx). NMR spectroscopy has been used to investigate the interaction of Fd, FTR, and an *m*-type Trx. Titrations indicated that FTR uses distinct sites to bind Fd and Trx simultaneously to form a non-covalent ternary complex. The orientation of Trx-*m* relative to FTR was determined from intermolecular paramagnetic broadening caused by FTR's [4Fe-4S] cluster. A model of the non-covalent binary complex of FTR/Trx-*m* based on the paramagnetic distance restraints suggested that rotation of Trx takes place when the non-covalent binary complex proceeds to a subsequent covalent complex.

A series of site-directed mutants of the ferredoxin-dependent spinach nitrite reductase has been used to identify several amino acids involved in the interaction of the enzyme with Fd. In a complementary study, binding constants to nitrite reductase and steady-state kinetic parameters of site-directed mutants of Fd were determined in an attempt to identify ferredoxin amino acids involved in the interaction with nitrite reductase. The results have been interpreted in terms of an *in silico* docking model for the 1:1 complex of Fd with nitrite reductase. All eight tryptophan residues present in spinach nitrite reductase were replaced, one at a time, by both non-aromatic and aromatic amino acids using site-directed mutagenesis. The effects of these replacements on steady-state kinetic parameters with Fd as the electron donor and on activity with methyl viologen, a non-physiological electron donor, were measured, as were the effects on K_d 's for substrate binding and on the prosthetic groups' redox properties. The results of this study indicate that none of the tryptophan residues is directly involved in electron transfer.

Flash photolysis was used to study the kinetics of electron transfer from reduced Fd to spinach nitrite reductase. It was demonstrated that a His-tagged, recombinant form of the enzyme and the enzyme isolated directly from spinach leaf displayed essentially identical values for k_{cat} (450 electrons per second per nitrite reductase molecule) and for the rate constant for reduction by Fd (1200 s^{-1}) despite the fact that the heme group of the recombinant enzyme has a slightly more negative E_m value than does the leaf enzyme. The rate constant for reduction by Fd and the thermodynamics of Fd binding were shown to be the same for oxidized nitrite reductase and for its reduced, NO-bound intermediate. Spectral and kinetic analyses suggest that reduction of the NO intermediate results in reduction of the enzyme's [4Fe-4S] cluster with little, if any, reduction of NO, indicating that the enzyme must "wait" for the arrival of another electron from reduced Fd before further reduction of NO, possibly to hydroxylamine.

Expression levels of the six Fd isoforms found in the green alga, *Chlamydomonas reinhardtii*, were measured under a variety of nutritional and environmental conditions and it was demonstrated that each of the FDX genes is differentially regulated in response to nutrient supply. Four of these Fds were localized to the chloroplast using isoform-specific antibodies (This portion of the work was carried out by Aimee Terauchi in the laboratory of Prof. Sabeeha Merchant at UCLA). Two of the chloroplastic Fds, Fd (the most abundant form) and Fdx2, were

expressed and Fdx2 was shown to have an unusually positive redox midpoint potential. Steady-state kinetic experiments with three different target enzymes (FTR, nitrite reductase and NADP⁺ reductase) suggest that the enzymes exhibit substrate specificity for the two different Fd isoforms.

The redox properties of FAD and two disulfide/dithiol couples in Erv1, a sulfhydryl oxidase that functions in the import of cysteine-rich proteins in the mitochondrial intermembrane space of *Saccharomyces cerevisiae*, were measured. Erv1 forms a 1:1 complex with cytochrome c, within which reduced Erv1 reduces cytochrome c. Reduced Erv1 also reduces oxygen, generating hydrogen peroxide, which is then reduced to water by cytochrome c peroxidase. Cytochrome c peroxidase is then reduced by the cytochrome c originally reduced by Erv1.

Science Objectives for 2009-2010:

- To use NMR spectroscopy to determine the solution structure of a Ga-substituted ferredoxin and to use this substituted ferredoxin to map interaction domains on NADP⁺ and phycobilin reductases.
- To use site-directed mutagenesis to identify amino acid residues in nitrite reductase involved in prosthetic group binding to the apo-protein and nitrate to the holo-enzyme.
- To use kinetic and spectroscopic methods to identify partially-reduced intermediates in the reaction catalyzed by nitrite reductase, with a particular emphasis on the role of enzyme-bound hydroxylamine.
- To use site-directed mutagenesis to identify the ferredoxin-binding domain on a cyanobacterial glutamate synthase.
- To use flash photolysis to study electron transfer from ferredoxin to nitrate reductase and to phycobilin reductase.

References to work supported by this project, 2007-2009:

1. J. N. Tripathy, M. Hirasawa, S.-K. Kim, A. T. Setterdahl, J. P. Allen, and D. B. Knaff (2007) "The role of tryptophan in the ferredoxin-dependent nitrite reductase of spinach," *Photosynth. Res.* **94**, 1-12.
2. D. Dabir, E. P. Leverich, S.-K. Kim, F. D. Tsai, M. Hirasawa, D. B. Knaff, and C. M. Koehler (2007) "A role for cytochrome c and cytochrome c peroxidase in electron shuttling from Erv1," *EMBO J.* **26**, 4801-4811.
3. M. Hirasawa, J. N. Tripathy, R. Somasundaram, M. K. Johnson, M. Bhalla, J. P. Allen and D. B. Knaff (2009) "The interaction of spinach nitrite reductase with ferredoxin: A site-directed mutation study," *Molecular Plant* **2**, 407-415.
4. P. Sétif, M. Hirasawa, N. Cassan, B. Lagoutte, J. N. Tripathy, and D. B. Knaff (2009) "New insights into the catalytic cycle of plant nitrite reductase. Electron transfer kinetics and charge storage," *Biochemistry* **48**, 2828-2838.
5. A. M. Terauchi, S.-F. Lu, M. Zaffagnini, S. Tappa, M. Hirasawa, J. N. Tripathy, D. B. Knaff, P. J. Farmer, S. D. Lemaire, T. Hase, and S. S. Merchant (2009) "Pattern of expression and substrate specificity of chloroplast ferredoxins from *Chlamydomonas reinhardtii*," *J. Biol. Chem.* **282**, in press.
6. X. Xu, P. Schürmann, J.-S. Chung, S.-K. Kim, M. Hirasawa, J. N. Tripathy, D. B. Knaff, and M. Ubbink (2009) "The ternary protein complex of ferredoxin, ferredoxin/thioredoxin reductase, and thioredoxin studied by NMR," submitted to *J. Am. Chem. Soc.*

cpSRP-based Protein Targeting To Thylakoid Membranes

Ralph L. Henry*, Principal Investigator

T.K.S. Kumar[†] and Robyn L Goforth*, Co-PIs

601 SCEN Biological Sciences Dept.* and CHEM 235 Chemistry & Biochemistry Dept.[†]

1 University of Arkansas, Fayetteville AR 72701-1201

Email: ralph.henry@uark.edu; Web: <http://www.uark.edu/ua/henrylab>

Overall research goals: Our research aims are designed to uncover mechanistic details that enable chloroplast signal recognition particle (cpSRP) and its receptor (cpFtsY) to target light harvesting chlorophyll-binding proteins (the LHCS) to the Albino3 (Alb3) translocase for insertion into thylakoid membranes. Toward this goal we are: (1) combining mutagenesis and functional studies with structural and biophysical analysis to identify the mechanistic role of lipid-induced structural transitions in the N-terminus of cpFtsY; (2) Identifying interaction sites on cpFtsY that promote its binding to a chloroplast specific subunit of SRP (cpSRP43), an event that appears linked with lipid-induced conformational changes in the N-terminus of cpFtsY; (3) using NMR to determine the structure of cpSRP43 and identify binding interfaces between cpSRP43 and its interaction partners, such as those that form a cpSRP-LHCP soluble targeting complex in the chloroplast stroma.

Most significant achievements 2007-2009 [adapted from the editor's summary of Marty et al. (2009) published in the same issue of JBC in recognition of this article's selection as Paper Of The Week]:

SRPs and their associated receptors work together to ensure that proteins are correctly transported to the cytoplasmic membrane (prokaryotes), endoplasmic reticulum (eukaryotes), or thylakoid membrane (chloroplasts). The SRP receptors for both *Escherichia coli* and chloroplasts (EcFtsY and cpFtsY) partition between a membrane-bound and soluble phase. The mechanism behind the binding of cpFtsY to membranes was previously unknown. Marty et al. showed that a membrane-binding motif at the cpFtsY N-terminus is necessary and sufficient for cpFtsY attachment to the thylakoid membrane. Thylakoid-binding activity was retained if a corresponding motif from *E. coli* was used, confirming the high conservation of this domain. In addition, it was found that the N-terminal lipid-binding motif plays a critical

role in governing cpFtsY GTPase activity; lipid binding to the N-terminal domain stimulates GTP hydrolysis, a prerequisite to achieve high rates of LHC targeting/insertion. Removal of the lipid binding motif stimulated GTPase activity even in the absence of lipids indicating that this motif functions as a negative regulator of GTP hydrolysis until cpFtsY is localized to the thylakoid, where cpFtsY gains its cpSRP receptor function.

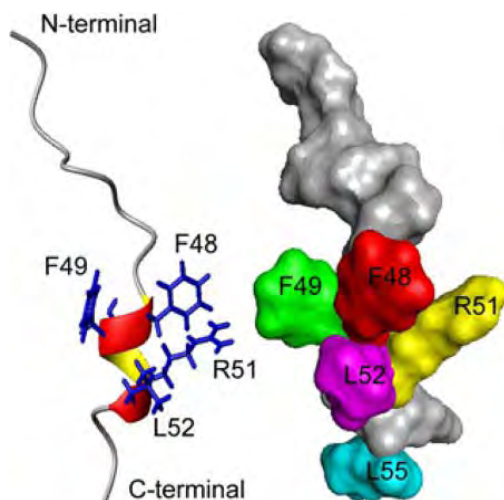

Figure 1. Backbone and space-filling models of the cpFtsY N-terminal region as determined by NMR, revealing the presence of a local amphipathic structure well suited for membrane binding.

Science objectives for 2009-2010:

- In collaboration with Laurent Nussaume (see Tzvetkova-Chevolleau et al. below), we showed that in the absence of cpSRP54 and cpFtsY, cpSRP43 retains an ability to bind thylakoid membranes and in doing so becomes part of a complex containing the Alb3 translocase. We are continuing to uncover the functional significance of this interaction, which is sensitive to protease pretreatment of thylakoids and appears critical to promote efficient interaction between Alb3 and SRP GTPases (cpSRP54 and cpFtsY). Having now identified the membrane binding target of cpSRP43 and demonstrated the role of this binding event in promoting GTP hydrolysis, we are preparing our results for publication.
- Mutagenesis and binding studies have demonstrated that cpSRP43 domains responsible for binding to thylakoid membranes also interact with LHCs. Structural studies along with protein interaction assays will be used to determine whether cpSRP43 binding to thylakoid membranes results in structural changes that trigger release LHC from cpSRP at the thylakoid.

References to work supported by this project between 2007-2009:

1. Marty, NJ, R Dakshinamurthy, AD Kight, NE Lewis, D Fologea, TKS Kumar, **RL Henry**, RL Goforth (2009). The membrane-binding motif of chloroplast signal recognition particle receptor (cpFtsY) regulates GTPase activity. **J. Biol. Chem** 284(22), 14891-14903
2. Ananthamurthy, K, KM Kathir, A Kight, RL Goforth, **RL Henry**, TKS Kumar (2008). ^1H , ^{13}C and ^{15}N Resonance Assignments of the C-terminal Chromo domain of the chloroplast signal recognition particle. *J Biomolecular NMR Assignments* 2(1):37-39.
3. KM Kathir, D Rajalingam, V Sivaraja, A Kight, RL Goforth, C Yu, **RL Henry**, TKS Kumar (2008). Assembly of Chloroplast Signal Recognition Particle involves Structural Rearrangement in cpSRP43 **J Mol Biol** 381(1):49-60
4. Lewis, P, I Fritch, RE Gawley, **RL Henry**, A Kight, JO Lay, R Liyanage, J McLachlin (2008). Dynamics of saxitoxin binding to saxiphilin c-lobe reveals conformational change. **Toxicon**. 51:208-217.
5. **Henry, RL**, RL Goforth, D Scheunemann (2007). Chloroplast SRP/FtsY and Alb3 in Protein Integration into the Thylakoid Membrane; In **The Enzymes (Volume 25; Molecular Machines Involved In Protein Transport Across Cellular Membranes)**, Ross E. Dalbey, Carla Koehler, and Fuyuhiko Tamanoi Editors.
6. Tzvetkova-Chevolleau T, C Hutin, LD. Noël, RL Goforth, JP Carde, S Caffarri, I Sinning, M Groves, JM Teulon, NE Hoffman, **RL Henry**, M Havaux and L Nussaume (2007). Canonical SRP components can be bypassed for post-translational protein targeting in chloroplasts. **Plant Cell**. 19(5):1635-48.

Energetics of protein transport across chloroplast membranes

Steven M. Theg, Principal Investigator

Department of Plant Biology, University of California – Davis, Davis, CA 95616

Email: smtheg@ucdavis.edu: Web: <http://www-plb.ucdavis.edu/labs/theg/>

Overall research goals: The overall research objectives of this project are to use bioenergetics as a window into the mechanism of action of numerous protein transporters involved in chloroplast biosynthesis. To this end, we have investigated 1) the nature of the energetic input to protein transport reactions at the thylakoid membrane, 2) the energetic cost of protein transport across chloroplast membranes with the ultimate goal of determining the contribution of this process to the total energy balance of the cell, 3) the mechanism through which Vipp1 stimulates the transport of proteins across the thylakoid membrane and its possible relation to thylakoid energetics, and 4) identification of the transport motor responsible for powering protein transport across the chloroplast envelope membranes.

Significant achievements 2007-2009: Earlier studies funded by the DOE demonstrated that the cost for transport of a substrate protein into the thylakoid lumen on the cpTat pathway was far higher than the cost of the protein's initial biosynthesis. While we continue to investigate the parameters that control the energetics of this pathway, we have turned our attention to determining the energetic cost of protein transport across the envelope membranes. In contrast to the protonmotive force dependence of transport on the cpTat pathway, import of proteins across the envelope membranes depends on ATP. The presence of many ATP-utilizing reactions within the chloroplasts has made accurate quantitation of a translocation ATPase reaction challenging, and we are still working on the reproducibility of our results. Nevertheless, our preliminary indications are that the envelope transport reaction is, while costly, not nearly as costly as that at the thylakoid membrane (a representative experiment is shown in Table I).

We have also examined the nature of the stimulation of thylakoid transport on the cpTat pathway by Vipp1, a protein thought to be involved in envelope to thylakoid vesicle traffic. In bacteria the Vipp1 homolog has been shown to facilitate the maintenance of the protonmotive force in membrane destabilizing conditions, leading to the working model that Vipp1 stimulate cpTat transport by increasing the magnitude of the driving protonmotive force in thylakoids. We have shown that Vipp1 apparently does not alter the pH gradient developed across the thylakoid membrane under different light regimes (Fig. 1), and are working now to determine whether the same is true for the transmembrane electric field.

Finally, we have demonstrated that an Hsp70 chaperone functions in the import of proteins across the envelope membranes. As with mitochondria, we believe this chaperone contributes to the energetics of the transport motor in chloroplasts, very likely in conjunction with Hsp93, a protein in the Hsp100 family of molecular chaperones.

Rate of ATP hydrolysis without prSSU (mol·mg Chl ⁻¹ ·hr ⁻¹)	1.60 x 10 ⁻⁶
Rate of ATP hydrolysis with prSSU (mol·mg Chl ⁻¹ ·hr ⁻¹)	1.82 x 10 ⁻⁶
Rate of prSSU translocation (mol·mg Chl ⁻¹ ·hr ⁻¹)	1.67 x 10 ⁻¹⁰
ATP hydrolyzed per protein translocated	2094

Table I. Calculation of the cost of protein import across the chloroplast envelope membranes. Chloroplasts were incubated with DCMU and tentoxin for 30 min prior to the addition of γ -labeled AT[³²P]. The import reaction proceeded at room temperature for 15 min, then the sample was recovered and protein imported and [32P] released was determined.

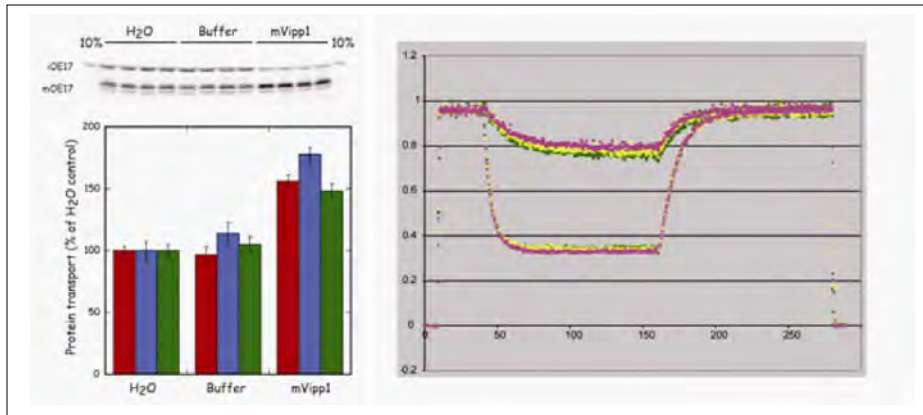

Figure 1. Left: Stimulation of iOE17 transport by Vipp1. Gel shows a representative experiments; bar graph shows results from three such experiments performed on separate days, each with samples in triplicate. Buffer and mVipp1 refer to additions of protein solubilization buffer without and with 2.35 μ g Vipp1, respectively. **Right: Vipp1 addition is without effect on Δ pH at saturating (lower traces) or sub-saturating (upper traces) light.** Red, addition of water; yellow, addition of Vipp1 buffer only; green, addition of Vipp1.

of the light-induced electrical component of the thylakoid protonmotive force. We will also determine where in the cpTat transport cycle the stimulatory effect of Vipp1 is manifested.

- We will continue our efforts to define the parameters that control the amount of protonmotive force energy powering protein transport on the cpTat pathway.

References to work supported by this project 2007-2009:

- Braun, N.A. and Theg, S.M. (2008) The cpTat pathway transports substrates in the dark. *J. Biol. Chem.* 283:8822-8828.
- Theg, S.M. (2009) Measurement of the Energetics of Protein Transport across the Chloroplast Thylakoid Membrane. In *Methods in Molecular Biology: Protein Secretion Protocols*, ed. A. Economou (Humana Press, Totowa, New Jersey), *in press*.
- Theg, S.M. and Lo, S.M. (2009) Protein Targeting Across and Into Chloroplast Membranes. In *Methods in Molecular Biology: Photosynthesis Research Protocols*, ed. R. Carpentier (Humana Press, Totowa, New Jersey), *in press*.
- Shi, L.-X. and Theg, S.M. (2009) A stromal Hsp70 system functions in protein import into chloroplasts in the moss *Physcomitrella patens*. *Submitted*.

Science objectives for 2009-1010:

- We will continue to optimize the protein translocation ATPase assay depicted in Table I. With this optimized assay we will test the effect of protein size and structural stability on the energy required to import proteins across the envelope membranes.

- We will determine whether Vipp1 alters the magnitude or duration

Interaction of Antenna Carotenoid and Retinal in the Light-driven Proton Pump Xanthorhodopsin

Janos K. Lanyi, Principal Investigator

Sergei P. Balashov, Co-PI

Department of Physiology & Biophysics, University of California, Irvine, U.S.A.

E-mail: jk_lanyi@uci.edu; Web: http://www.faculty.uci.edu/profile.cfm?faculty_id=2216

Overall research goals: We study the light-harvesting antenna in a unique dual-chromophore carotenoid/retinal protein that functions as a light-driven transmembrane proton pump, xanthorhodopsin, a protein related to bacteriorhodopsin. Understanding energy migration in a simple one-donor/one-acceptor system should yield insights to how light-receptors optimize capturing photons.

Significant achievements 2007-2009: From measurements of retinal fluorescence we calculated the approximate distance between the carotenoid the retinal and their angle, and concluded that the carotenoid binding site has a specific location in xanthorhodopsin. The excited-state energy transfer was described with femtosecond kinetic measurements. From xanthorhodopsin crystals that we grew, we obtained a 1.9 Å resolution x-ray diffraction structure, and positively identified the binding site (Figure 1).



Figure 1. Overall structure of xanthorhodopsin to indicate the positions of the seven transmembrane helices, the retinal (purple) and salinixanthin (orange). The extracellular surface of the membrane is at the lower ends of the helices.

In keeping with the specific aims in the original proposal, in this period we described structural changes the L, N and O intermediates of the bacteriorhodopsin photocycle, using crystallographic and spin-labeling approaches. The results define the changes at the retinal in L, and the timing of the large-scale conformational changes, and their reversal, in the second half of the transport cycle.

Science objectives for 2009-2010: Recently we found that gloeobacter rhodopsin can be reconstituted with the carotenoid of salinixanthin, and we will take advantage of a high-yield *E. coli* based expression system for this protein to construct mutations at the binding site. We expect that the results will define the determinants of the carotenoid and retinal binding sites, and the excited-state energy exchange.

Partial list of references to work supported by this project 2007-2009:

J. K. Lanyi and B. Schobert. Structural Changes in the L Photointermediate of Bacteriorhodopsin. *J. Mol. Biol.* 365: 1379-1392, 2007.

D. Chen, J. M. Wang and J. K. Lanyi. Electron Paramagnetic Resonance Study of Structural Changes in the O Photointermediate of Bacteriorhodopsin *J. Mol. Biol.* 366: 790-805, 2007.

S. P. Balashov, E. S. Imasheva, J. M. Wang, and J. K. Lanyi. Excited-state Energy Transfer and the Relative Orientation of Retinal Carotenoid in Xanthorhodopsin. *Biophys.J.* 95: 2402-2414, 2008.

E.S. Imasheva, S. P. Balashov, J.M. Wang, E. Smolensky, M. Sheves and J. K. Lanyi. Chromophore Interaction in Xanthorhodopsin-Retinal Dependence of Salinixanthin Binding. *Photochem Photobiol.* 84: 977-984, 2008.

H. Luecke, B. Schobert, J. Stagno, E. S. Imasheva, J. M. Wang, S. P. Balashov and J. K. Lanyi Crystallographic Structure of Xanthorhodopsin, the Light-Driven Proton Pump with a Dual Chromophore. *Proc. Natl. Acad. Sci. U. S. A.* 105: 16561-16565, 2008.

T. Polívka, S. P. Balashov, P. Chábera, E. S. Imasheva, A. Yartsev, V. Sundström and J. K. Lanyi. Femtosecond Carotenoid to Retinal Energy Transfer in Xanthorhodopsin. *Biophys.J.* 96: 2268-2277, 2009.

D. Chen and J. K. Lanyi. Structural Changes in the N and N' States of the Bacteriorhodopsin Photocycle. *Biophys. J.* 96: 2779-2788, 2009.

Resolving protein-semiquinone interactions by two-dimensional pulsed EPR spectroscopy

Sergei Dikanov, Principal Investigator

Antony R. Crofts, Robert B. Gennis, Colin A. Wraight, Co-PIs

University of Illinois at Urbana-Champaign (UIUC), Urbana, IL 61801

Email: dikanov@illinois.edu; Web: <http://ierc.scs.uiuc.edu/>

Overall research goals: Our focus is on use of modern, high-resolution EPR spectroscopy to explore the catalytic domains trapped in states with semiquinone (SQ) as an intermediate. The catalytic sites we propose to study, - the Q_A and Q_B -sites of the reaction center, the Q_I -site of the bc_1 complex, and the Q_H -site of the bo_3 quinol oxidase, - all operate using ubiquinone, but have different electron transfer partners, and different operating potentials. EPR probes interactions between the electron spin of SQ and local magnetic nuclei, which provide direct information about *spatial* and *electronic* structure of the SQ and the immediate protein and solvent environment. The main question to be addressed is that of how the protein environment modifies the spatial and electronic structure of the SQ in different sites to fit the physiological function. It is well known that the local environment modifies the electronic state of the SQ in each protein. However, there is no complete quantitative characterization of these effects. Such knowledge is crucial for detailed understanding of redox properties and electron transfers involving SQ states.

Significant achievements 2007-2009:

Semiquinone in the Q_H site of cytochrome bo_3 ubiquinol oxidase. *E. coli* cytochrome bo_3 ubiquinol oxidase (cyt bo_3) catalyzes the oxidation of ubiquinol in the cytoplasmic membrane with reduction of O_2 to water. An SQ intermediate is generated at a high affinity quinone binding site (Q_H). The X-ray structure of cyt bo_3 does not contain any bound quinone, but site-directed mutagenesis studies have suggested a role for residues R71, D75, H98, and Q101, which modulate the properties of the Q_H site. Our results described below provide new contributions to the development of a structural model of the site.

Comparative characterization of hydrogen bond network in wild-type bo_3 and its mutants. Our previous pulsed EPR work has shown that the Q_H SQ formed during the catalytic cycle is a neutral species, with two strong H-bonds, to oxygen of D75 and to a nitrogen of either R71 or Q101. Further pulsed EPR work has been extended using two mutants at the Q_H site (refs.1,2). The D75E mutation has little influence on the catalytic activity, and as we found the pattern of hydrogen bonding similar to the wild type. In contrast, the D75H mutant, where the intermediate SQ is also stabilized, is virtually inactive. Pulsed EPR revealed significant structural changes in this mutant. The H-bond to a nitrogen of R71 or Q101 (present in both the wild type and D75E oxidases) is missing in the D75H mutant. Instead, the D75H has a single, strong H-bond to a histidine, likely H75. As a result the D75H mutant stabilizes an anionic SQ. Either the redistribution of charge density in the SQ species, or the altered hydrogen bonding network is responsible for the loss of catalytic function.

Identification of the nitrogen donors hydrogen bonded with the semiquinone. Selective ^{15}N isotope labeling was used to identify the nitrogen involved in the formation of strongest H-bond with the Q_H SQ in the cyt bo_3 . 2D ESEEM experiments with a series of selectively ^{15}N labeled bo_3 proteins have directly identified the N_ϵ of R71 as the H-bond donor carrying the most transferred unpaired spin density. In addition, selective ^{15}N labeling has allowed us for the first time to determine weak hyperfine couplings with the side-chain nitrogens from all residues R71, H98, and Q101 around the SQ and to characterize pathways of the unpaired spin density transfer from the SQ to the protein. Particularly, a smaller amount of spin density is transferred on the nitrogens of H98, indicating its involvement in the weaker interaction with the SQ (ref. 3).

The SQ in model system and other quinone processing sites. Three classes of protons can contribute to the ESEEM/ENDOR spectra of SQs in different environments: non-exchangeable protons of quinone substituents; exchangeable protons forming H-bonds to the quinone oxygens;

and H-bonds associated with the protein or solvent in the immediate vicinity. The major spectroscopic problem in EPR studies of these systems arises from the many contributing protons, and their overlapping spectra, which create difficulties in their individual characterization. One approach to overcoming this problem is by partial or full deuteration of the quinones, and by using deuterated solvents. The anion-radicals of UQ₀ selectively deuterated in either methyl or methoxy groups, or with both groups fully labeled, and decyl-UQ, were prepared *in vitro* in different polar and non-polar solvents. The deuteration of substituents simplifies the 2D ESEEM and ENDOR spectra and allows an unambiguous assignment of peaks from their protons. Solvent deuteration was used to resolve the interaction with H-bonded protons for quinones of different structure including duroquinone, UQ₀, decyl-UQ, and UQ₁₀. An important finding from these experiments is that the hyperfine coupling with protons of solvent H-bonds with the carbonyl oxygens are similar for all quinones and are not altered by the bulky side chain substituents on the UQs. The strength of the coupling is smaller than the largest couplings found for H-bonded protons in proteins. Thus, all changes of the couplings observed for the SQs *in vivo* must result from the protein environment, and the location and geometry of suitable H-bond donors.

Science objectives for 2009-2010:

- The selective ¹⁵N labeling of nitrogens in different has also been applied to the D75H mutant, where the nitrogen from His residue, presumably H75, carries most of the unpaired spin density instead of N_ε of R71 in wild-type *bo*₃. Nothing was known about the fate of the H-bond with N_ε of R71. The selective labeling applied has shown only weak interactions with all nitrogens of R71. Construction of a comparative structural model showing the H-bonding in wild-type and D75H *bo*₃, based on the hyperfine couplings with side-chain nitrogens, will be completed after quantitative analysis of ¹⁵N HYSCORE spectra, currently in progress.
- We will apply a biochemical approach for selective ¹³C labeling of methyl groups in methyl and methoxy substituents in the SQ. Well-resolved lines from ¹³C labeled methyls in 2D ESEEM were obtained for the SQ in the *cyt bo*₃. We plan the preparation of the ¹³C labeled quinone in wild-type *bo*₃, followed by isolation, and incorporation into the mutants. The isolated labeled quinone will also be used for the experiments in model alcohol solutions to obtain reference spectra for characterization of the protein influence on the SQ. The quinones biochemically labeled in *bo*₃ enzyme can also be used in studies of the SQs in bacterial reaction center and *bc*₁ complex.
- H-bonds with histidine N_δ and with a peptide nitrogen of His M219 and Ala M260, respectively, were reported for Q_A⁻ in reaction centers of *Rb. sphaeroides*. Previous studies have left uncertainties about hyperfine couplings with these nitrogens, and this has frustrated the simulations exploiting different structural models of the Q_A-site in the SQ state. We will complete a 2D ESEEM study of the nitrogen couplings for the Q_A-site SQ using proteins with ¹⁴N and ¹⁵N isotopes.

References to work supported by this project 2007-2009:

1. Yap, L.-L., Samoilova, R.I., Gennis, R.B., Dikanov, S.A. Characterization of mutants that change the hydrogen bonding of the semiquinone radical at the Q_H site of the cytochrome *bo*₃ from *Escherichia coli*. *J. Biol. Chem.* **2007**, 282, 8777-8785.
2. Yap, L.-L., Samoilova, R.I., Lin, M.T., Gennis, R.B., Dikanov, S.A. The semiquinone at the Q_H site of the cytochrome *bo*₃ from *Escherichia coli*. *Biochim. Biophys. Acta* **2008**, 1777, S73.
3. Lin, M.T., Samoilova, R.I., Gennis, R.B., Dikanov, S.A. Identification of the nitrogen donor hydrogen bonded with the semiquinone at the Q_H Site of the cytochrome *bo*₃ from *Escherichia coli*. *J. Am. Chem. Soc.* **2008**, 130, 15768-15769.

Membrane-attached Electron Carriers in Photosynthesis and Respiration: Structure, Function and Maturation of *c*-type Cytochromes

Fevzi Daldal, Principal Investigator

Andreia Verissimo, Postdoctoral Fellow

University of Pennsylvania, Department of Biology, 103B Lynch Building, 433 S. University Avenue, Philadelphia, PA 19104-6018

Email: fdaldal@sas.upenn.edu;

Web: <http://www.bio.upenn.edu/faculty/daldal/>

<http://www.med.upenn.edu/camb/faculty/mv/daldal.html>

Overall research goals: To contribute to a detailed mechanistic understanding of cellular energy transduction pathways, including photosynthesis (Ps) and respiration (Res), using the facultative phototrophic bacteria of *Rhodobacter* species as experimental models. Current focus is on the nature, mechanism of function, and biogenesis of bacterial cytochromes (cyt), which are key electron carriers in chemical energy (ATP) production pathways. An ongoing emphasis is on the *c*-type cytochrome maturation processes.

Significant achievements in 2007-2009: 1- We have constructed and characterized biochemically and spectroscopically our novel cyt *bc*₁-*c*_y fusion complex. We initiated studies using its unusual features, like varying the length of the linker portion of cyt *c*_y, to probe macromolecular organizations of Ps- and Res-ET components in energy transducing membranes. This approach allows us to estimate the physical distances between the ET-components that form larger macromolecular assemblies for efficient ET processes (5, 6). 2- We continue to pursue aggressively the *c*-type cyts maturation (Ccm) studies (1, 3). Current issues are the role of the thioredox loop for stereo-selective heme ligation to apocyts, and biochemical characterization of the heme ligation core complex (CcmFHI) and its interactions with other Ccm partners (7, 8).

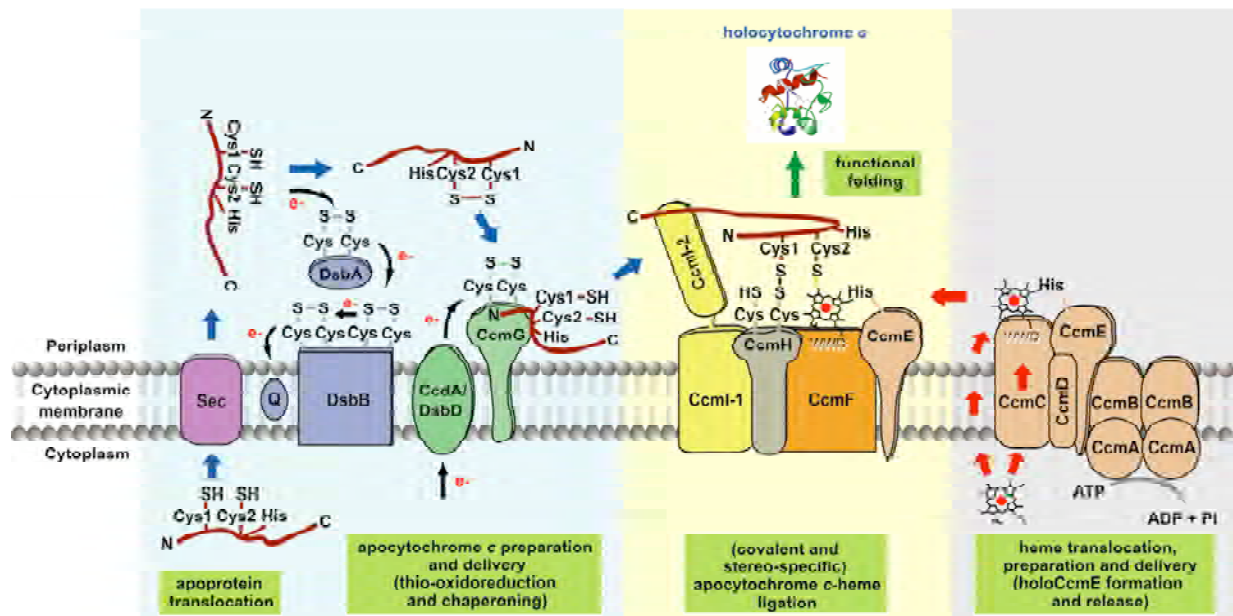

Figure 2: Production of *c*-type cytochromes according to Ccm system I. In many Gram-negative bacteria, ten specific components are organized as three distinct modules to produce various *c*-type cytochromes. The pathways thought to be followed by the apocytochrome *c* and heme *b*, from extracytoplasmic delivery to covalent heme ligation and folding into an active

cytochrome, are indicated with thick arrows. Ccm system I-specific protein components of **Module 1** (Heme Translocation and Relay, right) is drawn as a complex with the ATP hydrolyzing subunits CcmA and their partners CcmB, CcmC and CcmD that load heme *b* to CcmE. **Module 2** (Apocytochrome *c* Thioredox and Chaperoning, left) is shown together with the Sec translocon and the extracytoplasmic thio-oxidation (DsbA and DsbB) and thiorreduction (CcdA and CcmG) components forming a thioredox loop (small arrows for e⁻ transfer steps), first oxidizing and then reducing the cysteines at the heme binding motifs (Cys1-XXX-XXX-Cys2-His) of apocytochromes *c*. **Module 3** (Apocytochrome *c* and Heme *b* Ligation, middle) contains CcmI, CcmH, and CcmF thought to interact with apocytochrome *c* and heme *b* loaded holoCcmE to achieve formation of stereospecific thioether bonds. The “?” indicate the unknown steps of the Ccm process.

Science objectives for 2009-2010:

- 1- Continue the studies related to Ccm components purification, antibody production and their biochemical characterization (7, 8).
- 2- Continue the studies related to the role of DsbA/disulfide bond formation/Cu trafficking and insertion into the cytochrome *c* oxidase active site, and differential membrane subproteomics of OlsA-minus mutants to define membrane protein composition changes (2, 4).
- 3- Time permitting, initiate the characterization of membrane super complex formation in the presence of the cyt *bc*₁-*c*_y fusion complex under respiratory growth conditions and comparison to anoxygenic photosynthetic conditions (5, 6).

References to work supported by this project 2007-2009:

1. Sanders, C., C. Boulet and **F. Daldal**. (2007) Membrane-spanning and periplasmic segments of CcmI have distinct functions during cytochrome *c* biogenesis in *Rhodobacter capsulatus*. *J. Bacteriol*, **189**: 789-800.
2. Aygun-Sunar S., Bilaloglu R., Golfine, H. and F. Daldal. (2007) *Rhodobacter capsulatus* Ornithine Lipid Biosynthesis Enzyme OlsA is Also Proficient for Phosphatidic Acid Biosynthesis. *J. Bacteriol*. **189**: 8564-8574.
3. Sanders, C., Turkarlan, S., Onder, O., Frawley, E. R., Kranz, R.G., Koch H. G. and **F. Daldal**. (2008) Biogenesis of *c*-type cytochromes and cytochrome complexes. In “The Purple Phototrophic Bacteria” (Eds., Hunter, Daldal, Turnauer and Beatty). pp. 407-423. Springer, Dordrecht, The Netherlands.
4. Onder, O, S, Turkarlan, D. Sun and **F. Daldal**. (2008) Overproduction or Absence of the Periplasmic Protease DegP Compromises Severely Bacterial Growth in the Absence of the Dithiol:Disulfide Oxidoreductase DsbA. *Mol. Cell. Proteomics* **7**: 875-90.
5. Ozturk, Y., D-W. Lee, S. Mandaci, A., Osyczka, R. C. Prince and **F. Daldal**. (2008) Soluble variants of membrane-anchored cytochrome *c*_y of *Rhodobacter* species are efficient photosynthetic electron carriers. *J. Biol Chem*. **283**: 13964-13972.
6. Lee. D-W., Y. Ozturk, A., Osyczka, J. W. Cooley and **F. Daldal**. (2008) Cytochrome *bc*₁-*c*_y fusion complexes reveal the distance constraints for functional electron transfer between photosynthesis components. *J. Biol. Chem*. **283**: 13973-13982.
7. Turkarlan, S., Sanders, C., Ekici, S. and **F. Daldal**. (2008). Compensatory Thio-redox Interactions between DsbA, CcdA and CcmG During Cytochrome *c* Maturation in *Rhodobacter capsulatus*. *Molec Micro*. **70**: 652-666.
8. Sanders, C., Turkarlan, S., Lee, D-W., Onder, O., Kranz, R. G., and **F. Daldal**. (2008). The Cytochrome *c* Maturation Components CcmH, CcmI and CcmF Form a Multisubunit Membrane Complex in *Rhodobacter capsulatus*. *J. Biol. Chem*. **283**: 29715-29722.

Enhancement of Photoassimilate Utilization by Manipulation of ADPglucose Pyrophosphorylase and Phosphorylase

Thomas W. Okita, Principal Investigator

Seon-kap Hwang Co-PI

Institute of Biological Chemistry, Washington State University, Pullman, WA 99164-6340

Email: okita@wsu.edu; Web: <http://www.wsu.edu/~tokita>

Overall research goals: The research objectives are to study the protein structure-function relationships of ADPglucose pyrophosphorylase (AGPase) and phosphorylase and to elucidate their physiological roles during plant growth using tools and resources developed by this laboratory. Specifically, we will (1) determine the substrate and effector binding properties of homotetrameric LS and SS AGPase forms and various heterotetrameric LS-SS enzymes containing different subunit variants; (2) de-evolve the AGPase LS to identify peptide domains essential for catalysis and allosteric regulation; (3) elucidate molecular and biochemical changes in gene expression and metabolite levels using RNA profiling and metabolomic approaches in plants engineered for enhanced starch metabolism in leaves and developing seeds; (4) determine whether the transport of ADPglucose across the amyloplast membrane limits starch synthesis; and (5) characterize the catalytic properties of plastid phosphorylase and identify its ADPglucose effector site. Results from these biochemical and physiological studies will increase our fundamental understanding how these important starch regulatory enzymes operate at the molecular level and *in planta*, which will aid efforts to increase the utilization of plants as a renewable source of energy.

Significant achievements 2007-2009:

Studies were completed on assessing the major metabolites in transgenic developing rice seeds expressing a bacterial AGPase mutant enzyme. As expected, ADPglc levels were elevated and seed weights increased although the % increases were substantially higher for AGPase levels than seed weight (Fig. 1). In addition to ADPglc, the levels of Glc 1-P, Glc 6-P, and UDPglc were also elevated in the transgenic plants. These results indicate that ADPglc formation is no longer a limiting step in starch synthesis and that a downstream process (ADPglc transport or utilization of ADPglc by starch synthases) constrains maximum carbon flow into starch

Kinetic analysis of a mutant LS homotetramer AGPase form indicated very little catalytic activity and was unaffected by the activator 3-PGA and inhibitor Pi. However, when assembled with the catalytically-silenced SS, the resulting heterotetrameric AGPase had significant catalytic activity and was allosterically regulated. These results provide further evidence that the enzyme properties of AGPase are a product of subunit synergy between the LS and SS.

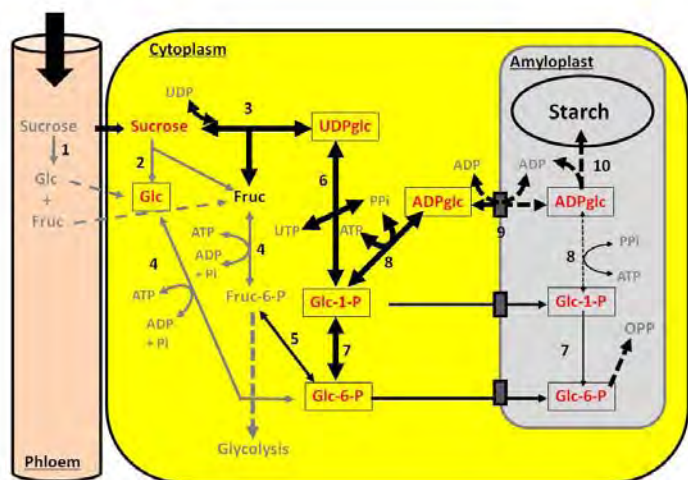

Fig. 1. The primary carbon metabolic pathway from sucrose to starch in developing rice seeds. The enzyme catalyzed reactions leading to ADPglc synthesis and subsequently into starch in developing rice endosperm are depicted. The major flux of carbon from sucrose into starch are shown in bold arrows while minor reactions are depicted with thin arrows.

Co-assembly of the LS activated forms, UpReg1 and UpReg2, with the SSs from potato, Perilla, and lettuce generated AGPase enzymes with enhanced sensitivity to 3-PGA activation and enhanced resistance to Pi inhibition. Transgenic lettuce expressing UpReg1 showed larger aerial biomass, suggesting that increased leaf starch metabolism resulted in higher photosynthetic capacity and, in turn, increased vegetative growth.

Rice mutants for the phosphorylase PhoI were identified which showed severe starch deficiency at low temperature. Analysis of the kinetic properties of the recombinant rice phosphorylase PhoI indicated that it favored the synthetic reaction or the phosphorolytic reaction as evidenced by the net incorporation of ^{14}C -Glc 1-P in the presence of 20-fold excess of Pi. This result provides evidence that PhoI may contribute to one or more early events involved in starch synthesis.

Science objectives for 2009-2010:

- Characterize the effector binding properties of homotetrameric AGPase LS and SS forms as well as various AGPase heterotetrameric form.
- Express and characterize the kinetic properties of the plastid phosphorylase and identify the ADPglucose effector binding site.
- Generate transgenic rice plants over-expressing the BT1, the ADPglucose transporter, and assess its effect on starch synthesis.

References to work supported by this project 2007-2009:

- 1 Hwang, S.-K, S. Hamada, and T.W. Okita 2007 Catalytic implications of the higher plant ADP-glucose pyrophosphorylase large subunit. *Phytochem.* 68:464-477.
- 2 Lee, Sang-Kyu, · Seon-Kap Hwang · Muho Han · Hong-Gyu Kang · Yulyi Han · Sang-Bong Choi · Man-Ho Cho · Seong Hee Bhoo · Gynheung An · Tae-Ryong Hahn · Thomas W. Okita · Jong-Seong Jeon 2007 Identification of ADP-glucose pyrophosphorylase isoforms essential for starch synthesis in leaf and seed endosperm of rice (*Oryza sativa* L.) *Plant Mol. Biol.* 65:531-546
3. Kim, D., S.K. Hwang and T.W. Okita (2007) Subunit interactions specify the allosteric properties of potato tuber ADP-glucose pyrophosphorylase. *Biochem. Biophys. Res. Comm.* 363:301-306.
4. Hwang, S.K., Y. Nagai, D. Kim, and T.W. Okita (2008) Direct appraisal of the potato tuber ADP-glucose pyrophosphorylase large subunit in enzyme function by study of a novel mutant form. *J. Biol. Chem.* 283:6640-6647.
5. Satoh, H., K. Shibahara, T. Tokunaga, A. Nishi, M. Tasaki, S.-K. Hwang, T.W. Okita, N. Kaneko, N. Fujita, M. Yoshida, Y. Hosaka, A. Sato, Y. Utsumi, T. Ohdan and Y. Nakamura (2008) Plastidic α -Glucan Phosphorylase Mutation Dramatically Affects the Synthesis and Structure of Starch in Rice Endosperm. *Plant Cell* 20:1833-1849.
6. Lee, S.-M., Ryu, T.-H., Kim, S.-I., Okita, T.W., and Kim, D. (2009) Kinetic and regulatory properties of plant ADP-glucose pyrophosphorylase genetically modified by heterologous expression of potato *upreg* mutants in vitro and in vivo. *Plant Cell Tiss. Organ Cult.* 96:161-170.
7. Nagai, Y., C. Sakulsingharoj, G.E. Edwards, H. Satoh, T.W. Greene, B. Blakeslee, and T.W. Okita (2009) Control of starch synthesis in cereals: metabolite analysis of transgenic rice expressing upregulated cytoplasmic ADP-glucose pyrophosphorylase in developing seeds. *Plant Cell Physiol.* 50:635-643.

Controlling Electron Transfer Pathways in Photosynthetic Reaction Centers

Dewey Holten, Principal Investigator

Christine Kirmaier and Robert E. Blankenship, Co-PIs

Department of Chemistry, Washington University, One Brookings Drive, St. Louis, MO 63130

Deborah K. Hanson and Philip D. Laible, Co-PIs

Biosciences Division, Argonne National Laboratory, 9700 S. Cass Ave., Lemont, IL 60439

Email: holten@wustl.edu; Web: http://www.chemistry.wustl.edu/dewey_holten

Overall research goals: Photosynthetic reaction centers (RCs) convert light energy into chemical energy in a series of extremely efficient electron transfer reactions, accomplishing transmembrane charge separation. The structures of RCs reveal two symmetry-related branches of cofactors that are functionally asymmetric; bacterial RCs use the A pathway exclusively (Figure 1). Our goal is to understand the architectural and energetic factors that underlie the directionality and yields of electron transfer, and our hypothesis is that we can generate a mutant RC that uses the B pathway preferentially and efficiently. Site-specific mutagenesis has produced transmembrane charge separation (giving the oxidized primary donor and reduced quinone) solely via B-branch activity, but the best overall yield is still very low (~15%). Insights from previous attempts at rational design have provided neither the means nor understanding necessary to engineer an efficient B-branch electron-transfer pathway. Therefore, we intend to produce such an RC via directed molecular evolution, implementing streamlined mutagenesis and high-throughput spectroscopic screening steps to sample a large number of RC variants. The insights and tools that emerge will be of general importance and applicability. Our primary experimental vehicle will be the RC from the purple photosynthetic bacterium *Rhodobacter capsulatus*. The effort will be complemented through the mutagenesis of the related RC from the green photosynthetic bacterium *Chloroflexus aurantiacus*, which bears key differences in cofactors and amino acid sequence. The proposed research will expand significantly our understanding of the structure/function relationships that dictate the efficiency of biological energy-conversion reactions. These concepts are necessary for *de novo* design of bio-inspired assemblies capable of both efficient charge separation and charge stabilization.



Figure 1. The A- and B-branches of cofactors in the bacterial RC. P, bacteriochlorophyll dimer; B_A & B_B, bacteriochlorophylls; H_A & H_B, bacteriopheophytins.

Significant achievements 2009: This project began September 2009.

Science objectives for 2009-2010: Our hypothesis is that it should be possible to generate a mutant RC that uses the B pathway preferentially for efficient light-induced transmembrane charge separation. To accomplish this goal, we will pursue the following research plan:

1. A. Identify a large number of residues near the cofactors (Figure 2) involved in (i) the initial branching of electron transfer and (ii) subsequent secondary electron-transfer steps and use these residues as mutagenesis targets. The starting template for construction of these mutations will be the current mutant genes of *R. capsulatus* that produce RC complexes that we have already shown are capable of substantial B-branch electron transfer to Q_B [e.g., the YFHV mutant (see Figure 3 legend)]; these mutant RCs cannot reduce Q_B via the A-branch cofactors.

B. Generate a large number of variants of the L and M genes of the RC complex. To facilitate a plate-based approach to this task, we will optimize the existing *R. capsulatus* mutagenesis system for use with the Robotic Molecular Biology Facility in the Biosciences Division at ANL. We will also utilize the robots for plate-based automated purification of screening-level amounts of RCs via capture on affinity chromatography resin.

2. Identify promising candidates among the new mutant RCs by using time-resolved optical absorption and emission spectroscopy (subpicoseconds to tens of seconds timescales) and steady-state UV-vis absorption spectroscopy. These spectroscopies will be made amenable to higher-throughput analysis by adapting the optical arrangements for probing samples in 96-well plates and automating sample positioning and data collection capabilities. Examples of the ultraslow spectroscopic analyses to be performed at WU to dissect the activities of the A- and B-branch cofactors to give membrane-spanning charge separation are shown in Figure 3. Ultrafast absorption and emission studies to characterize the initial stages of charge separation also will be initiated.

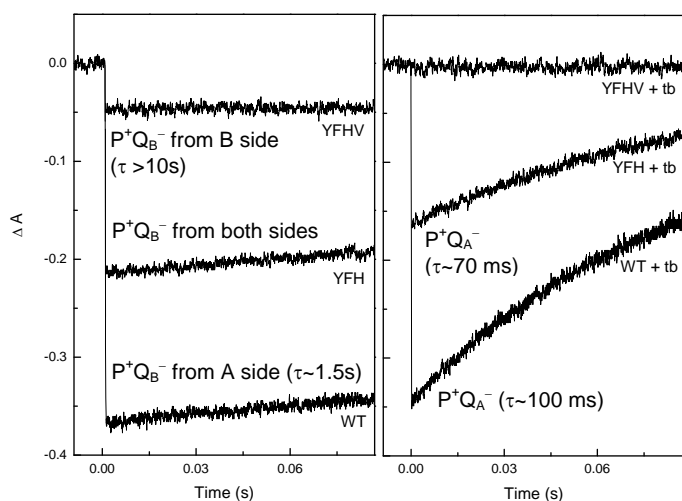

Figure 3. Initial stages of decay of the P^+Q^- states after a 30-ps flash, giving the relative yields and insights into the route of $P^+Q_B^-$ formation. $P^+Q_B^-$ is formed only via the B side in the YFHV mutant RC (top left). Terbutryn (tb) inhibits Q_B binding (right), giving a signal due to $P^+Q_A^-$ (wild-type=WT or YFH mutant) or no signal in the YFHV RC. The “Y” and “F” mutations, F(L181)Y and Y(M208)F, alter the free energies of $P^+B_B^-$ and $P^+B_A^-$, respectively, the “H” mutation L(M212)H causes replacement of H_A with a bacteriochlorophyll denoted β and the “V” mutation W(M250)V prevents binding of Q_A .

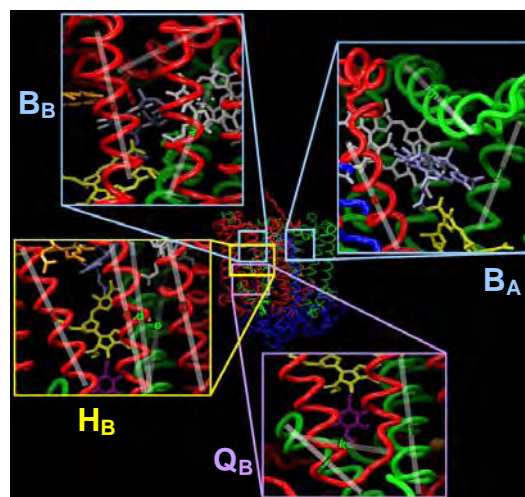

Figure 2. A 3D-view of the segments of the L (green) and M (red) RC subunits that will be substituted, separated into focus areas by their proximities to the cofactors whose energetics or electronic couplings are being targeted. Cofactors: P (white), B_A and B_B (blue), H_A and H_B (yellow), carotenoid (orange), Q_A and Q_B (purple), and non-heme iron (orange).

3. Employ selection of photo-competent phenotypic revertants as a complementary, function-driven approach to the generation of an RC that can support cell growth through sole use of the B-branch of cofactors for cyclic, light-induced electron transfer.

4. Further modify the complex by combining mutations found in the most promising candidates. Photochemistry in selected mutant RCs that possess the newly activated electron transfer pathway will be characterized in more detail to understand how the mutations affect the rate constants of the electron transfer steps and the yields of the charge-separated states.

5. Begin construction of a strain of *R. capsulatus* that expresses the *Chloroflexus* RC complex heterologously for use as a test bed to uncover novel, important structure-function relationships (and test the generality of others) related to the directionality of electron transfer that are important to all phototrophic organisms.

Integration of the light and dark reactions of oxygenic photosynthesis: NADPH/NADP⁺ ratio controls the expression of the high affinity inorganic carbon concentrating mechanism (CCM)

Robert L Burnap, Principal Investigator

Shawn M.E. Daley, Marla Carrick, and Anthony Kappell,

Ph.D. Candidate, Undergrad, and Postdoctoral Research Associate

Dept. Microbiology & Molecular Genetics

403 Life Sciences East, Oklahoma State University, Stillwater OK 74078

Email: rob.burnap@okstate.edu

Background: Sustained photosynthetic fluxes depend on an ample supply of inorganic carbon (C_i) for the carbon-fixing reactions of the Calvin-Basham-Benson (CBB) cycle. Without adequate C_i , the products of the light reactions, NADPH and ATP, tend to accumulate, with potentially damaging consequences. Cyanobacteria have evolved an intricate C_i concentrating mechanism (CCM) that consists of membrane-bound power converters, coupled transporters, and micro-compartmentalized enzymes. Under low carbon conditions, which are particularly relevant for many bioenergy applications, as much as 15% of the power throughput of the cell can be devoted to this process (1). Consistent with its energetic expense, the expression of the CCM is tightly regulated and, while considerable progress has defined the outlines of this C_i uptake system, its regulation has remained more elusive.

Overall research goals: This project aims to define the C_i regulatory circuitry that controls the expression of the cyanobacterial CCM and its integration with the rest of photosynthetic metabolism, notably, the light reactions. Previous global transcriptional analysis (2) led to the hypothesis that a LysR-type transcriptional regulator, *CcmR*, controls a regulon expressing an integrated system of proteins at the basis of the CCM: Type I dehydrogenases concentrate C_i directly via the CUP subsystem or indirectly via a sodium gradient generated by the NdhD5/NdhD6 subsystem used to drive *SbtA*. **Key project aims include:**

1. Physical evidence that *CcmR* indeed interacts with the upstream regions of the genes in the proposed *CcmR* regulon.
2. Identify photosynthetic metabolites that modulate the activity of the regulator so as to connect the state of the C_i availability to the repressor activity of *CcmR*.

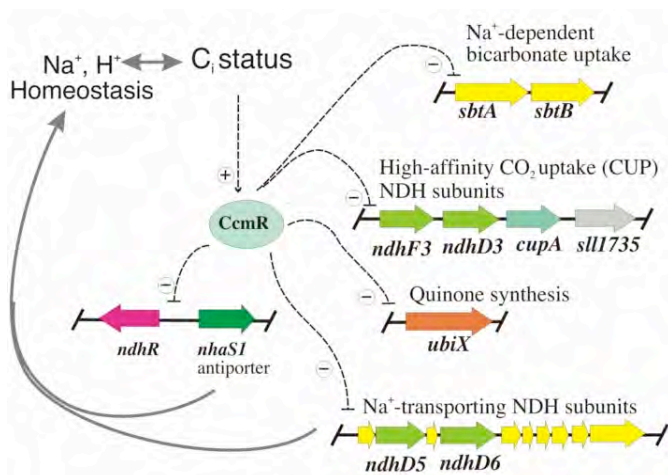

Figure 1. Hypothesized regulatory circuit for the control of genes for the CCM. The hypothesized *CcmR* regulon based upon microarray and RT-PCR analysis of the $\Delta ccmR$ deletion mutant. This model depicts that *CcmR* (CyanoBase orf slI1594) regulates genes encoding Na^+ translocating proteins and both CO_2 and HCO_3^- uptake systems.

Research Progress 2008-2009: This first phase of the project has been aimed at testing the hypothesis that *CcmR* indeed interacts with the DNA regulatory region of the genes shown in **Figure 1**. Further, we sought to determine the metabolite(s) that modulate the repressor activity of *CcmR* since this would provide information on the regulatory connection between the cellular state of C_i demand and the expression of the C_i acquisition system. In both regards, very interesting results have been obtained (3):

1. Electrophoretic mobility shift assays data provide the first physical evidence of direct and specific binding of CcmR to of the hypothesized target control DNA sequences exactly as predicted by inference from the microarray experiments (**Fig. 1**).
2. A Surface Plasmon Resonance (**SPR**) technique was developed to accurately evaluate the binding characteristics of CcmR with regulatory DNA sequences under quasi-equilibrium conditions. This is a state-of-the-art microfluidic SPR instrument (Nomadics, Stillwater, OK) that has very sensitive response characteristics ideal for these experiments.
3. Using SPR the very exciting result that NADP^+ acts as co-repressor of CcmR, causing the protein to bind more tightly to the control region of the gene and preventing the transcription of the CCM genes (**Fig. 2**). We suppose that under conditions of ample C_i , the consumption of NADPH by the CBB cycle keeps the level of oxidized co-factor, NADP^+ , relatively high keeping the CCM down-regulated. Low C_i has the opposite effect, releasing the expression of the CCM from repression by CcmR.

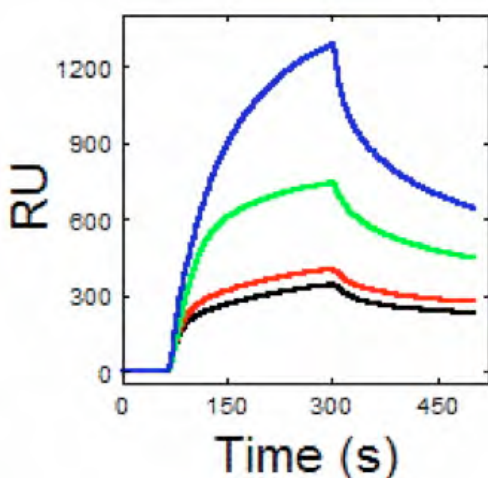

Fig. 2. Surface Plasmon Resonance (SPR) curves illustrating how NADP^+ promotes the binding of the transcription repressor to its regulatory DNA target. The transcriptional regulator protein CcmR was reacted with DNA corresponding to the promoter region of the key CCM gene, *CO₂ uptake gene A* (*cupA*, see Fig.1). The regulatory DNA sequence containing the promoter region was immobilized to the surface of the gold SPR sample surface. Heterologously expressed CcmR was then introduced via microfluidic flow. The vertical deflection reflects the extent of CcmR binding. This experiment illustrates the sharp NADP^+ dependence on the protein-DNA binding interaction with the *blue curve representing 500 μM NADP^+* and the *black having no NADP^+* added.

Research Objectives 2009-2010: The finding that NADP^+ is a key regulator of inorganic carbon acquisition provides important insight regarding the integration of the light and dark reactions of oxygenic photosynthesis. However, what additional biochemical details can be obtained regarding the regulation mechanism and how do these detailed features play out in terms of physiological dynamics in the face of different nutrient and light regimes?

1. Define the biochemical characteristics of the ternary CcmR-metabolite-DNA interaction. Preliminary data suggest that in addition to NADP^+ , α -ketoglutarate also serves as a co-repressor of CcmR. To get a better idea of the true physiological context of the regulation, the interactive effects of these ligands and the nature of the binding needs to be determined (e.g. tetramerization of CcmR is indicated), to derive a realistic kinetic model.
2. Development and use a flexible set of bioreactors for accurate physiological measurements. A prime objective will be to assay changes in $\text{NADPH}/\text{NADP}^+$ as a function of light and C_i and using different mutant strains. With the above findings, we now will begin construction of mutants predicted to alter reductant metabolism.

References

1. Ritchie, R. (1998) Bioenergetics of membrane transport in *Synechococcus* R-2 (*Anacystis nidulans*, *S. leopoliensis*) PCC7942, *Can J Bot* 76, 1127-1145.
2. Wang, H. L., Postier, B. L., and Burnap, R. L. (2004) Alterations in global patterns of gene expression in *Synechocystis* sp. PCC 6803 in response to inorganic carbon limitation and the inactivation of *ndhR*, a LysR family regulator, *J Biol Chem* 279, 5739-5751.
3. Daley, S. M. E., Kappell, A., Carrick, M., and Burnap, R. (in preparation) $\text{NADPH}/\text{NADP}^+$ ratio controls the expression of the high affinity inorganic carbon concentrating mechanism in cyanobacteria.

Session V

Comparative Studies of Homodimeric and Heterodimeric Type I Reaction Centers

John H. Golbeck, Principal Investigator

Department of Biochemistry and Molecular Biology; Department of Chemistry

301 South Frear Laboratory, The Pennsylvania State University, University Park, PA 16802

Email: jhg5@psu.edu; Web: <http://www.bmb.psu.edu/faculty/golbeck/golbeck.html>

Overall research goals: The objective of this work is to understand the mechanism by which light is transformed into chemical energy in homodimeric Type I reaction centers. In the last several years, we have made advances in our understanding of the protein and cofactor composition of the photosynthetic reaction center in heliobacteria (*Heliobacteriaceae*). These advances include: (1) removal of the low molecular mass polypeptide that contains the terminal F_A and F_B iron-sulfur and demonstrating in these P798- F_X cores that F_X^- charge recombines with $P700^+$ in 15 ms; (2) characterization of the F_X cluster as a $S = 3/2$ ground spin state [4Fe-4S] cluster in P798- F_X cores; and (3) cloning of the Fd2 gene and reconstitution with P798- F_X cores to recover the 75-ms kinetic phase due to the $P798^+$ [F_A/F_B] recombination. We subsequently renamed the Fd1 protein PshB in keeping with the accepted nomenclature of bacterial proteins.

Significant achievements 2007-2009: In this period, we have made the following advances:

- *Identification, cloning and expression of an alternative F_A/F_B -containing protein in Heliobacterium modesticaldum.* After determining the N-terminal amino acid sequence of PshB, we showed that the protein was encoded by the downstream member of a predicted dicistronic operon that harbored two genes named *fd1* and *fd2*. What is interesting is that the predicted Fd1 and Fd2 proteins are 61% identical and both contain two CxxCxxCxxx motifs characteristic of bacterial dicluster ferredoxins (Fig. 1). These similarities suggest that Fd1 shares similar biochemical functions with PshB. In this funding period, we were able to clone the *fd1* gene and overexpress and characterize His-tagged Fd1. Expression of recombinant Fd1 in *E. coli* proved to be difficult. Evaluation of the wild type gene against a codon usage table indicated that *fd1* contained 13 codons for tRNAs that were expressed poorly in *Escherichia coli*. Consequently, we replaced several of those codons with others expressed at higher levels, without changing the protein sequence. As a result, Fd1 could be expressed at higher levels for purification. We found that the Fe/S-reconstituted holoprotein, which we have renamed PshBII, is capable of binding to P798- F_X cores and that it is able to accept electrons directly from F_X at cryogenic and room temperatures.

N-terminal sequences		AYKITD
PshB (Fd2) <i>H. m.</i>	1	MAYKITD TACTACGACMDGCCVGAIVEG-KKYSITSDCVD CGVCADKCPVD AII PG* 55
Fd2 <i>H. mobilis</i>	1	MYKIDASQCTGCGACVSGCYTNAIVEANGKYTITDDCVD CGVCQDSCPVD AII KA 54
Fd1 <i>H.m.</i>	1	VVYKISDACVACGACEDACPVNAI IKG-DVYSITD ACIDCGTCADTCPAGAI SEG* 55
Fd1 <i>H. mobilis</i>	1	AYKISDACVNCGSCVDACPVGAIEKGSDIYCINDTCIDCGSCVD TCPAGAI SEG 54
		. * **.* * .** *.* *.* ** * * * *

Fig. 1. Deduced amino acid sequences of Fd1 (PshBII) and Fd2 (PshB) in *H. mobilis* and their counterparts in *H. modesticaldum* (*H.m.*). The N-terminal amino acid sequence of genuine PshB from *H. modesticaldum* is also shown.

- *Unifying principles in homodimeric type I photosynthetic reaction centers: Properties of PscB and the F_A , F_B and F_X iron-sulfur clusters in green sulfur bacteria.* Our finding in the last funding period that the F_X cluster in heliobacteria is in a $S = 3/2$ ground spin state and that the F_A/F_B protein is loosely-bound prompted us to re-examine the properties of the homologous iron-sulfur clusters in the homodimeric Type I reaction centers of green sulfur bacteria. SDS-PAGE and mass spectrometry showed that the PscB subunit, which harbors the F_A and F_B clusters, can be easily removed from the Chlorobium complexes by treatment with 0.5 M KCl. EPR spectroscopy of photoaccumulated Chlorobium complexes and cores showed resonances at $g = 3.4$ identified as a low-spin heme from cytochrome c_{551} , and between $g = 5.4$ and 4.4 assigned to a $S = 3/2$ ground state [4Fe-4S] $^{1+}$ cluster from F_X^- . These results serve to unify the properties of the acceptor side of the Type I homodimeric reaction centers found in green sulfur bacteria and heliobacteria: the F_A and F_B iron-sulfur clusters are present on a loosely-bound subunit, and F_X is present as an [4Fe-4S] $^{2+,1+}$ cluster with a significant population in a high-spin $S = 3/2$ ground state.

- *Comparative studies of the F_A/F_B protein in heterodimeric and homodimeric Type I reaction centers.* In this work, we provided an analysis of the assembly of the asymmetrically oriented PsaC subunit on the pseudo C_2 -symmetric Photosystem I (PS I) core and compared it with the equivalent F_A/F_B proteins in homodimeric Type I reaction centers. We propose that at the time when the heterodimeric reaction center came into existence, the presence of oxygen forced PsaC to bind tightly to the reaction center core. The differentiation of the reaction center into PsaA and PsaB subunits forced PsaC to lock into one of the two possible orientations. We showed that the extensive set of ionic and H-bonds between PsaC and the PsaA/PsaB heterodimer have evolved to ensure an exceedingly tight binding interface, thereby rendering the [4Fe-4S] clusters in PsaC inaccessible to dioxygen at the onset of oxygenic photosynthesis. Such a mechanism is not needed in heliobacteria or green sulfur bacteria, with the result that PshBI and PshBII in the former and PscB in the latter have retained some degree of mobility as loosely-bound proteins.

Science objectives for 2009-2010:

- *Determination of the HbRC binding specificity for PshBI and PshBII.* Our approach is to clone the genes for all four proteins, overexpress and purify the apoproteins in *E. coli* and insert the Fe/S clusters using inorganic reagents. The electron transfer capacity of each protein from the HbRC core will be determined using time-resolved optical spectroscopy and low temperature EPR spectroscopy. Our second goal is to measure the binding affinities using affinity chromatography techniques. His-tagged PshBI will be bound to a Ni-affinity column, and isolated HbRC cores will be added.
- *Characterization of a minimalist reaction center core from *H. modesticaldum*.* We have found that two methods that remove F_A/F_B -proteins from HbRC complexes. In one, detergent-solubilized heliobacterial membranes are treated with sodium chloride and the proteins separated via ultrafiltration over a 30kDa cut-off membrane. The F_A/F_B proteins pass through the membrane, while the HbRC core is retained. In the second, solubilized membranes are passed through an anion exchange column at pH 7.0 and the F_A/F_B proteins are retained while the HbRC core complex passes through. In this method, the HbRC core complex shows five bands in SDS-PAGE: a predominant band at 48 kDa that is PshA, and four additional bands at 16 kDa, 28 kDa, 30 kDa, and 35 kDa. To determine whether these additional proteins are functional in the HbRC complex, we have developed a method to purify PshA to homogeneity by working at very low ionic strengths using high-resolution anion exchange chromatography. Characterization of the highly purified PshA homodimer is underway and experiments to determine whether the additional proteins removed during this procedure are integral to the HbRC complex are planned.

References to work supported by this project 2007-2009:

- Heinnickel, M., Shen, G., and Golbeck, J. H. (2007) Identification and Characterization of PshB, the dicluster ferredoxin that harbors the terminal electron acceptors F_A and F_B in *Heliobacterium modesticaldum*, *Biochemistry* 46, 2530-2536.
- Heinnickel, M. and Golbeck, J. H. (2007) Heliobacterial Photosynthesis, *Photosyn. Res.* 92, 35-53.
- Jagannathan, B., and Golbeck, J. H. (2008) Unifying principles in homodimeric type I photosynthetic reaction centers: Properties of PscB and the F_A , F_B and F_X iron-sulfur clusters in green sulfur bacteria, *Biochim Biophys Acta* 1777, 1535-1544.
- Jagannathan, B., and Golbeck, J. H. (2009) Breaking biological symmetry in membrane proteins: the asymmetrical orientation of PsaC on the pseudo- C_2 symmetric Photosystem I core, *Cell Mol Life Sci* 66, 1257-1270.
- Jagannathan, B., and Golbeck, J. H. (2009) *Photosynthesis: Microbial*, in Encyclopedia of Microbiology, (2nd ed., 4-volume set), Lederberg, ed., Elsevier, Dordrecht, The Netherlands.
- Castro, C., Romberger, S. P., Golbeck, J. H. (2009) Identification and Characterization of PshBII, an Alternative F_A/F_B Protein in the Photosynthetic Reaction Center of *Heliobacterium modesticaldum*, (in preparation).

A Combined Genetic, Biochemical, and Biophysical Analysis of the A₁ Phylloquinone Binding Site of Photosystem I from a Green Alga

Kevin E. Redding, Principal Investigator

Dept. Chemistry & Biochemistry, Arizona State University, 1711 S Rural Rd, Tempe, AZ 85287-1604

Email: Kevin.Redding@asu.edu; Web: http://chemistry.asu.edu/faculty/K_Redding.asp

Overall research goals: The research objectives of this project are to understand how the polypeptide controls the redox properties of the embedded phylloquinone (PhQ) cofactors within Photosystem I (PS1). The primary electron donor (P₇₀₀, a pair of chlorophylls) is connected to the tertiary electron acceptor (F_X, an Fe-S cluster) via two branches of cofactors. Each branch contains a pair of chlorophylls (ec2 and ec3) and a PhQ (see Figure 1). These cofactors are bound by two related membrane polypeptides, PsaA and PsaB, in a pseudo-C₂-symmetrical structure. Using a combination of site-directed mutagenesis and spectroscopic analysis, we are trying to understand following: (1) The role of both branches in electron transfer within PS1, (2) How the PhQ sites influence the reduction potential of the bound cofactor, including the role of hydrophobic residues (overall character of the site), acidic residues (nearby negative charges), and H-bond donors; and (3) Which differences in the PhQ sites explain the 10-fold difference in rate of electron transfer (ET) from them to the next cofactor (F_X).

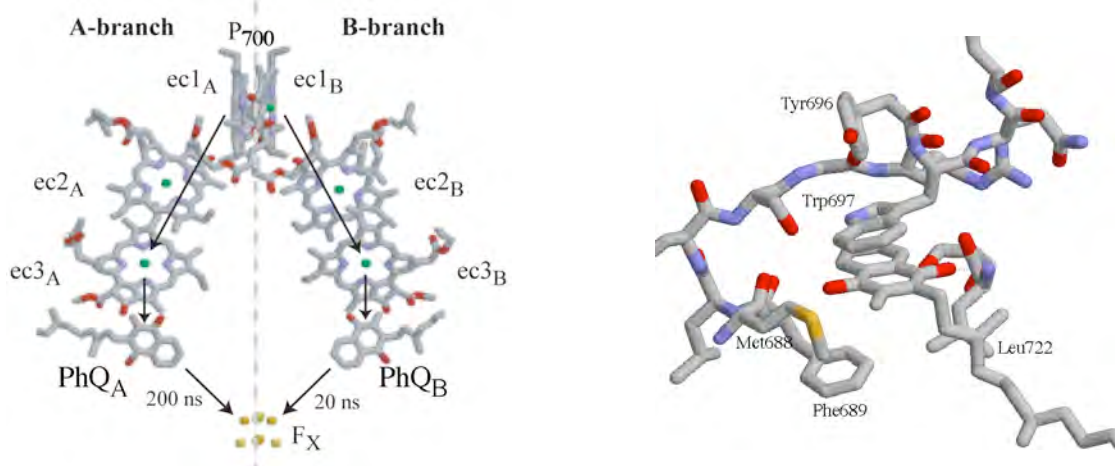

Figure 1. *Left Panel:* Arrangement of the core cofactors of Photosystem I. The pseudo-C₂ symmetry axis is shown as a dotted gray line dividing the two branches. For sake of clarity, the phytyl chains of the cofactors have been truncated and the terminal acceptors F_A and F_B are not shown. Reduction of the ec3 Chl(s) occurs in <100 ps, with subsequent electron transfer to the PhQ on a similar timescale. In the nanosecond timescale, the electron is transferred to F_X and then to F_A/F_B. *Right Panel:* View of PhQ_A from the “back”, approximately from the point of view of the ec3_A Chl. All residues within 5 Å of the phylloquinone are shown, but the cofactors (Chls and carotenes) have been omitted.

Significant achievements 2006-2009: We have created a series of site-directed mutations in the PhQ_A site that tests the effects of residues in the immediate vicinity of the cofactor (PsaA-Trp697, Ser692, Phe689, Leu722). Note that the amide N of PsaA-Leu722 donates a H-bond to PhQ_A, and it is thus not possible to remove it directly. We have, however, made substitutions at this residue designed to create steric clash with PhQ, thus lengthening the H-bond. In many cases, we have made the corresponding mutation in the PhQ_B site. Of the mutations that allow the assembly and accumulation of PS1, we have characterized all by pump-probe spectroscopy *in vivo* to determine rates of ET. During this process we have made the following discoveries: (1) that it is possible to control independently the directionality of ET down the 2 branches and the rate of ET from each PhQ; (2) that a nontrivial amount of ET takes place from PhQ_B to PhQ_A, mediated by F_X, and this can be diminished by increasing the driving force of ET from PhQ_A to F_X; (3) that strong steric clash at the PhQ_A site results in some PS1 centers lacking PhQ_A, presumably due to lowered affinity for the cofactor; and (4) that it is possible to observe a new kinetic component, which we assign to

ET from F_X to the F_A/F_B clusters, in mutants in which ET from PhQ_A to F_X is sufficiently slowed down.

Science objectives for 2009-2010:

- We will finish our analysis of the mutants in the PhQ_A and PhQ_B sites, in order to nail down the effects on kinetic of ET and quinone occupancy. The latter point will require a quantitative assay for quinone levels, which we are currently developing.
- One of our mutants (PsaA-F685N) produced the largest effect we have yet seen on ET from PhQ to F_X : a 100-fold decrease in rate (from ~ 200 ns to ~ 20 μ s decay time), which is now slower than the rate of ET from plastocyanin to P_{700}^+ (~ 5 μ s). This allows us for the first time to ask the question: *What happens when a second electron is sent down the chain while the first one is still there?* We have developed a triple-flash experiment to answer this question.
- In collaboration with John Golbeck (Penn State) and Art van der Est (Brock Univ.), we are studying key mutants by transient (laser-flash) EPR spectroscopy.
- We plan to use protein electrochemical techniques to estimate the effect of each mutation upon the reduction potential of PhQ_A and PhQ_B , in the hopes of estimating the effect upon driving force, and then ultimately the reorganization energy of the $PhQ \rightarrow F_X$ ET steps.
- We will start a new collaborative project with the group of John Golbeck (Penn State), with the goal of understanding the role of the menaquinone cofactors in the related type 1 reaction center of *Heliobacterium modesticaldum*.

References to work supported by this project 2006-2009:

1. Santabarbara, S., K. Reifschneider, A. Jasaitis, F. Gu, S. Audley, G. Agostini, D. Carbonera, F. Rappaport, K.E. Redding. (2009). Evidence for inter-quinone electron transfer in the reaction centre of Photosystem I of *Chlamydomonas reinhardtii*: altering the hydrogen bond to the phylloquinone(s) acceptors accelerate the rate of semi-quinone oxidation. *Manuscript in prep.*
2. Santabarbara, S., K.E. Redding, F. Rappaport. (2009). Temperature dependence of the reduction of P_{700}^+ by tightly bound plastocyanin *in vivo*. *Biochemistry, in revision.*
3. Santabarbara, S., A. Jasaitis, F. Gu, F. Rappaport, K.E. Redding. (2008). Additive Effect of Mutations Affecting the Rate of Phylloquinone Reoxidation and Directionality of Electron Transfer within Photosystem I. *Photochem. Photobiol.*, **84**:1381-7.
4. Redding, K. (2008). Photosystem I. In D. Stern (ed.), *The Chlamydomonas Sourcebook: Volume 2*. Academic Press.
5. Byrdin, M., Santabarbara, S., Gu, F., Fairclough, W., Heathcote, P., Redding, K. and Rappaport, F. (2006) Assignment of a kinetic component to electron transfer between iron-sulfur clusters F_X and $F_{A/B}$ of Photosystem I. *Biochim. Biophys. Acta*, **1757**, 1529-38.
6. Redding, K.* and A. van der Est. (2006). The Directionality of Electron Transfer in Photosystem I. In J. Golbeck (ed.), *Photosystem I: The Plastocyanin:Ferredoxin Oxidoreductase in Photosynthesis*. Kluwer Academic Publishers, Dordrecht. pp. 413-438.
7. F. Rappaport, B. Diner, and K. Redding. (2006). Optical measurements of secondary electron transfer in Photosystem I. In J. Golbeck (ed.), *Photosystem I: The Plastocyanin:Ferredoxin Oxidoreductase in Photosynthesis*. Kluwer Academic Publishers, Dordrecht. pp. 223-244.

Biophysical and biochemical studies on the cytochrome bo_3 ubiquinol oxidase from *Escherichia coli* and related systems

Robert B. Gennis, Principal investigator

Sergei Dikanov, Chad Rienstra, Satish Nair: collaborators

University of Illinois at Urbana-Champaign, Department of Biochemistry, Urbana, IL 61801

email: r-gennis@illinois.edu

Overall research goals: Our work is focused on the cytochrome bo_3 quinol oxidase from *E. coli*, with our primary goals being functional and structural studies. Cyt bo_3 is a member of the superfamily of heme-copper respiratory oxygen reductases. Several relatively small subgroups of this large collection of enzymes have evolved to directly oxidize quinol as the source of electrons to reduce dioxygen to water, thus bypassing the bc_1 complex (Complex III) or eliminating the need for Complex III altogether. The *E. coli* cyt bo_3 oxidase is the best studied of these quinol oxidizing enzymes. This enzyme oxidizes two equivalents of ubiquinol-8 in the *E. coli* cytoplasmic membrane and reduces O_2 to water. Four protons are pumped across the membrane ($1 H^+/e^-$), and 8 full charges are transferred across the membrane during each turnover, thereby generating a proton motive force. Cytochrome bo_3 has very strong sequence homology with the eukaryotic and prokaryotic cytochrome c oxidases, with a major difference being that the quinol oxidase lacks the site where cytochrome c is oxidized by the more traditional oxidases, as well as Cu_A , the metal center that is the initial oxidant of cytochrome c.

One major interest has been to characterize the details of the quinol binding sites of cyt bo_3 , and to determine how the enzyme modulates the electrochemical properties of the bound quinone species. The enzyme has both a high affinity ubiquinone, which acts as a cofactor, and a low affinity quinone binding site which exchanges with the Q-pool and is the substrate binding site. As part of this project we have begun to examine the closely related menaquinol-oxidizing aa_3 -600 oxidase from *Bacillus subtilis*. The major technique used for these studies is pulsed EPR, done in collaboration with Sergei Dikanov (UIUC).

A second major goal is to obtain additional structural detail of the active site of cyt bo_3 , primarily by using magic angle spinning solid state NMR. We have developed procedures to prepare excellent quality, selectively isotope labeled cytochrome bo_3 for NMR studies. Excellent quality data have been obtained by the group of our collaborator, Chad Rienstra (UIUC). As part of this effort, we have also initiated a study of a smaller, quinone-binding membrane protein, DsbB, which is involved in generating protein disulfide bonds in the periplasm of *E. coli*.

Significant achievements 2007-2009.

1. Demonstration that there must be two Q binding sites in cyt bo_3 : When the enzyme is isolated using the detergent dodecylmaltoside, 1 quinone is bound and has an EPR-detectable semiquinone stabilized by protein binding. The existence of a second Q binding site had not been clearly demonstrated, but postulated based on the effects of inhibitors. If there were only one Q binding site, then catalytic turnover of the enzyme using ubiquinol-1 as the substrate should displace ubiquinol-8. We quantified the amount of bound ubiquinol-8 before and after enzyme turnover with the alternate substrate, and found it unchanged. We conclude that the high affinity site does not rapidly exchange and, therefore, there must be a second Q binding site.

2. HQNO binding: When the Q-analogue HQNO binds to cyt bo_3 , the EPR signal from the semiquinone is abolished. A fluorescence quenching assay was used to show that 1 equivalent of HQNO binds with an affinity in the range of $5\mu M$. There is no evidence for competition with oxidized ubiquinone-1. Binding of HQNO does not displace the tightly bound endogenous ubiquinone-8. So far, the data suggest a separate HQNO binding site that must be very close to the high affinity quinone.

3. **Generation of *E. coli* auxotrophs for isotopic labeling of cyt bo₃:** Both EPR and NMR experiments require specific amino acids or sets of amino acids to be labeled with ¹⁵N and/or ¹³C. We have generated 23 different strains to be used for this purpose. These are genetically defined and in the C43 strain used for overproducing membrane proteins. We have successfully used these.
4. **Pulsed EPR shows the semiquinone H-bonding to arginine:** Using the auxotrophs developed above, we have selectively labeled cyt bo₃ and demonstrated a strong hydrogen bond to the ε-Nitrogen of the side chain of an arginine, almost certainly R71.
5. **Cloning, expression, EPR spectroscopy and mutagenesis of cyt aa₃-600 menaquinol oxidase from *B. subtilis*:** This enzyme is a very close homologue of cyt bo₃, but uses menaquinol instead of ubiquinol as a substrate. We have shown that the enzyme has a high affinity menaquinol binding site and that the high affinity quinone is in a similar location as is the ubiquinol in the *E. coli* enzyme. There are distinct differences, however.
6. **Magic angle spinning solid state NMR of cyt bo₃ and DsbB:** Excellent NMR spectra have been obtained for both the 144 kDa and 20 kDa membrane proteins. The chemical shifts of most residues in the DsbB transmembrane helices have been assigned. Pairwise labeling using histidine and tyrosine has been successful for cyt bo₃, as a critical step to assign the chemical shift of the unique His-Tyr crosslinked pair at the active site.

Science objectives for 2009-2010:

1. **Assign the chemical shifts of the active-site His-Tyr and other functionally important residues in cyt bo₃:** We have spectra already collected and prepared samples that should provide enough information to make assignments. It should be possible to determine if the tyrosine is protonated at neutral pH, a functionally important question. We can also determine changes within the active site upon reduction of the enzyme.
2. **Develop methods to assign the solid state NMR chemical shifts of bound ubiquinone-8 in cyt bo₃ in both oxidized and reduced forms:** Our eventual goal is to determine the hydrogen binding of both the oxidized and reduced ubiquinone to protein side chains and/or backbone residues. These data will complement the pulsed EPR data which defines the hydrogen bonding of the semiquinone form. These data can be used to define how the protein modulates the chemical properties of the bound quinone.
3. **Determine the structure of the aa₃-600 menaquinol oxidase from *B. subtilis* X-ray crystallography:** With our collaborator, Dr. Satish Nair, we have obtained crystals that diffract to 4.0Å. We hope to improve the diffraction in the next year and obtain a complete structure of the enzyme, with the high affinity menaquinone bound.
4. **Determine where the low affinity quinone site is located in cyt bo₃:** Mutagenesis as well as inhibitor binding will be used to determine where these binding sites are located.

References to work supported by this project 2007-2009:

- (1) Li, Y., Berthold, D. A., Frericks, H. L., Gennis, R. B., and Rienstra, C. M. (2007) Partial (¹³C and (¹⁵N) chemical-shift assignments of the disulfide-bond-forming enzyme DsbB by 3D magic-angle spinning NMR spectroscopy. *Chembiochem* 8, 434-42.
- (2) Li, Y., Berthold, D. A., Gennis, R. B., and Rienstra, C. M. (2008) Chemical shift assignment of the transmembrane helices of DsbB, a 20-kDa integral membrane enzyme, by 3D magic-angle spinning NMR spectroscopy. *Protein Sci* 17, 199-204.
- (3) Yap, L. L., Samoilova, R. I., Gennis, R. B., and Dikanov, S. A. (2007) Characterization of mutants that change the hydrogen bonding of the semiquinone radical at the QH site of the cytochrome bo₃ from *Escherichia coli*. *J Biol Chem* 282, 8777-85.
- (4) Lin, M. T., Samoilova, R. I., Gennis, R. B., and Dikanov, S. A. (2008) Identification of the nitrogen donor hydrogen bonded with the semiquinone at the Q(H) site of the cytochrome bo₃ from *Escherichia coli*. *J Am Chem Soc* 130, 15768-9.

Session VI

Improving Rubisco Performance in a Warmer World

Michael E. Salvucci and Archie R. Portis, Jr., Co-Principal Investigator

Anshuman Kumar and Csengele Barta, Postdoctoral Research Associates

US Arid-Land Agricultural Research Center, Maricopa, Arizona

Email: mike.salvucci@ars.usda.gov;

Web: http://www.ars.usda.gov/main/site_main.htm?modecode=53-47-00-00

Overall research goals: The research objectives are to examine Rubisco and activase as promising targets for improving the thermotolerance of plants by (1) obtaining additional fundamental knowledge on the interaction of Rubisco and activase, with special emphasis on aspects related to the decline of photosynthesis at moderately high temperatures; (2) exploring several transgenic amelioration strategies based on modifying activase. The knowledge gained during the proposed research will increase the prospects for using plants as renewable sources of biomass for fuel and materials, for obtaining an increased efficiency of photosynthesis in the higher temperature environments expected from global warming, and for using plants to increase the sequestration of atmospheric CO₂.

Significant achievements 2007-2009: *Proof of concept for improving the thermal tolerance of photosynthesis.* An important proof of concept was obtained with transgenic Arabidopsis plants containing a more thermal stable chimeric activase. Not only was photosynthesis much more heat tolerant in these transgenic plants, but seed yield and germination under very moderate heat stress was increased by 3- to 4-fold compared with wild-type. Interestingly, construction of the improved activase simply required replacing the Rubisco-recognition region (Box-VII' and Sensor-II) in the more thermally stable activase from tobacco with the region from Arabidopsis before inserting the tobacco activase into Arabidopsis plants. The success of these experiments provides incentive for attempting the same approach with a crop plant, especially since the strategy for producing more temperature-tolerant activase is much simpler than a strategy based on DNA shuffling.

Identification of a possible mechanism for thermal acclimation of photosynthesis. In experiments designed to identify mechanisms that protect activase and photosynthesis against thermal denaturation in vivo, we found that the chloroplast GroEL homolog, cpn60beta associates with Rubisco activase during heat stress. This association was uncovered using transgenic plants containing a tagged form of activase that allowed rapid purification of activase-associated proteins under very gentle conditions from extracts of heat-stressed plants. The finding of an in vivo association between cpn60-beta and activase suggests that cpn 60 plays an important role in acclimating photosynthesis to heat stress by protecting Rubisco activase from thermal denaturation. We are testing this hypothesis using the *len1* (cpn60-beta) mutant of Arabidopsis, as well as a variant of the tagged activase containing the tag on the N- instead of the C-terminus of the protein.

Identification of an important physiological factor contributing to the thermal instability of activase. In experiments designed to investigate the biochemical basis for Rubisco deactivation in response to moderate heat stress, we have uncovered a critical role for [Mg²⁺] in the thermal stability of activase. The high [Mg²⁺] typically used in most Rubisco experiments accelerates activase aggregation and subsequent precipitation from solution. This aggregation occurs at

lower temperatures with high $[Mg^{2+}]$, decreases the temperature required to inactivate the protein and masks formation of a high molecular mass aggregate of activase that remains soluble during heat stress. The results highlight the possibility that light-driven increases in $[Mg^{2+}]$ in the chloroplast destabilize activase during heat stress.

Science objectives for 2009-2010:

- With the proof of concept developed in this project, transgenic strategies for improving the thermal stability of photosynthesis in crop plants will be developed based on success with the chimeric approach. Although replacement of the total activase pool will be difficult or impossible with most crop plants, the evidence suggests that producing a modified activase will improve the thermal stability of Rubisco activation even if the modified activase is co-expressed with the native forms. Since over-expressing the unmodified longer form of activase also seems to offer a potential strategy for improving thermal tolerance of photosynthesis, transgenic plants with these constructs will also be produced.
- To enable studies of the effects of temperature on the Rubisco-activase interaction, we still must develop a binding assay. We have obtained transgenic tobacco that express a His-tagged Rubisco that will serve as the basis for developing a binding assay for activase-Rubisco. Preliminary experiments have shown that the His-tag does not interfere with activation of Rubisco by activase in vivo or in vitro, indicating that the binding interaction is normal with the modified Rubisco.
- To investigate the biochemical basis for Rubisco deactivation in response to moderate heat stress we are planning to use radiochemical detector after HPLC separation to measure production of catalytic misfire products produced by Rubisco under heat stress. The objective is to assess the relative contribution of catalytic misfire and decarbamylation to inactivation of Rubisco during heat stress. In addition, we have developed an assay for measuring Rubisco activase activity in leaf extracts. Once the assay is refined, we will examine the thermal stability of activase in extracts. i.e., under conditions with physiological ratios of Rubisco:activase.
- To resolve the structure of activase, we are collaborating with Dr. Rebekka Wachter at Arizona State University who is attempting to crystallize the activase protein.

References to work supported by this project 2007-2009:

1. A. R. Portis, Jr., C. Li, and M. E. Salvucci, "Regulation of Rubisco Activase and Its Interaction with Rubisco," *J. Expt. Bot* **59**: 1597-1604 (2008).
2. M. E. Salvucci, "Association of Rubisco Activase with Chaperonin-60beta: A Possible Mechanism for Protecting Photosynthesis During Heat Stress," *J. Expt. Bot* **59**: 1923-1933 (2008).
3. A. Kumar, and A. R. Portis, Jr., "Arabidopsis Thaliana Expressing a Thermostable Chimeric Rubisco Activase Exhibits Enhanced Growth and Higher Rates of Photosynthesis at Moderately High Temperatures," *Photosynth. Res.* **100**: 143-153 (2009).

Production of Biofuels and Value-Added Products via Solar and Chemical Energy Driven Bioconversions of CO₂ Fixing Microbes: Control of CO₂ Assimilation

F. Robert Tabita, Principal Investigator

Dept. Microbiology, The Ohio State University, 484 West 12th Ave., Columbus, OH 43210-1292

E-mail: Tabita.1@osu.edu Web:

Introduction. It is clear that the levels of atmospheric carbon dioxide are increasing, and many discussions relative to the causes and consequences of increased CO₂ levels constantly appear in the popular press. Moreover, all biofuel enterprises currently being considered result in the production of copious quantities of CO₂. Although conversion of plant feedstock to CO₂ as a waste product of biofuel fermentative processes may be considered a carbon neutral process, the amount of CO₂ produced will be staggering as biofuel production becomes a viable source of energy. Any process that is developed to somehow convert this CO₂ to useful products must, of necessity, be concerned with the mechanisms used by microorganisms to regulate CO₂ assimilation. In our research project, we probe the molecular mechanisms employed by anaerobic photosynthetic bacteria to regulate CO₂ fixation. In these organisms, the structural genes of the Calvin-Benson-Bassham (CBB) pathway

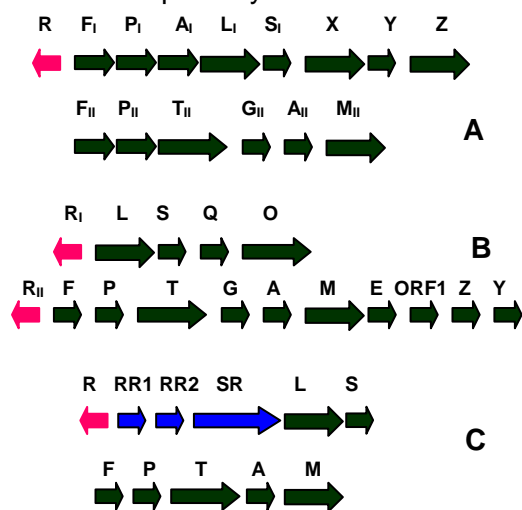

Fig. 1. Organization of *cbb* genes into *cbb_I* (upper cluster) and *cbb_{II}* (bottom cluster) operons in *Rhodobacter spheroides* (A), *Rb. capsulatus* (B), and *Rhodopseudomonas palustris* (C).

genes of the Calvin-Benson-Bassham (CBB) pathway are organized in two major (*cbb*) operons (Fig. 1), in which a divergently transcribed gene (*cbbR*) encodes for a regulator protein that controls the expression of the *cbb* operons of each organism.

Overall research goal. The overall objective of this research is to attain an understanding of the biochemical and structural features of CbbR that enable this protein to modulate CO₂ fixation (*cbb*) gene expression, and subsequent product formation from CO₂. In addition, we will determine how CbbR may interact with other regulator proteins shown to be involved with controlling *cbb* gene transcription.

Significant achievements (2008-2009). Along with CbbR, it had been previously shown that a two-component system, the RegAB system, also controls *cbb* transcription in *Rb. sphaeroides* (1). Both CbbR and RegA are DNA binding proteins with helix-turn-helix motifs for DNA interaction.

DNA binding sites for both proteins are found in the regulatory regions of the *cbb_I* and *cbb_{II}* operons in *Rb. sphaeroides*. RegA has four DNA binding sites in the *cbb_I* promoter. The CbbR binding site and RegA binding site 1 were found to overlap each other upstream of the *cbb_I* operon in *Rb. sphaeroides*, as demonstrated by footprint analysis (1,2). These studies suggested that CbbR and RegA might interact on the *cbb* promoter and form a complex. It was recently found that CbbR and RegA do interact and CbbR must be bound to DNA for this protein-protein interaction to occur. Conversely, *cbb_I* promoter binding by RegA is not required for interaction with CbbR. In addition, the presence of RegA enhances the ability of CbbR to bind the *cbb_I* promoter. Gel mobility shift analysis demonstrated that RegA binds to *cbb_I* promoter DNA and forms incrementally larger multimeric complexes with DNA as the concentration of RegA increases. To gain an understanding of how these proteins interact, specific mutants of RegA have been generated that cannot bind CbbR. A model has been generated to potentially explain how this specific complex of CbbR and RegA may interact with RNA polymerase to influence and maximize *cbb* transcription (3).

By contrast, the Reg system does not appear to play a significant role in *cbb* control in *Rps. palustris*. In this organism, the *cbb_I* CO₂ fixation regulon contains a unique two-component system (referred to as the CbbRRS system) juxtaposed between the master transcriptional regulator CbbR and genes encoding form I RubisCO (*cbbLS*). The CbbRRS system is an atypical two-component system consisting of a sensor kinase (CbbSR) and two response regulators (CbbRR1 and CbbRR2) (Fig. 1C) with no apparent DNA binding domains on any of these proteins. Recent physiological/genetic studies have shown that the CbbRRS system plays a regulatory role in modulating the expression and activity of form I RubisCO only during photoautotrophic (CO₂) growth and not during photoheterotrophic (benzoate) growth (4). We have recently shown that the bacterial two hybrid system enabled the identification of specific protein – protein interactions between the transcriptional regulator CbbR and CbbRR1, response regulator 1 of the CbbRRS system. Site directed mutagenesis of the phosphoacceptor residues of CbbRR1 (D54N and H171D) did not affect its interaction with CbbR significantly, suggesting that phosphorylation of CbbRR1 may not be important for the interaction. Gel mobility shift analyses revealed that the affinity of CbbR for the *cbb_I* promoter was specifically enhanced in the presence of CbbRR1, while the presence of CbbRR2 in the complex decreased the mobility of the DNA – protein complex. The interactions of the response regulators with CbbR represent additional transcriptional control beyond that provided by CbbR alone, for fine tuning the expression of form I RubisCO in *Rps. palustris*.

Objectives for 2009-2010. We will continue to define and maximize the ability of one-component and two-component transcription factors to modulate control of CO₂ fixation in photosynthetic bacteria. We will focus on domains that are particularly relevant to the function of these proteins.

References.

1. Romagnoli, S., and Tabita, F. R. Carbon dioxide metabolism and its regulation in nonsulfur purple photosynthetic bacteria. In, Hunter C.N., Daldal F., Thurnauer M.C., and Beatty J. T. (2009) *The Purple Phototrophic Bacteria. Advances in Photosynthesis and Respiration*, Vol. 28, Springer, Dordrecht, The Netherlands, pp. 563-576.
2. Dubbs, J. M., and Tabita, F. R. Interactions of the *cbb_{II}* promoter-operator region with CbbR and RegA(PrrA) regulators indicate distinct mechanisms to control expression of the two *cbb* operons of *Rhodobacter sphaeroides*. *J. Biol. Chem.* **278** (2003) 16443-16450
3. Dangel, A. W., and Tabita, F. R. Protein–protein interactions between CbbR and RegA (PrrA), transcriptional regulators of the *cbb* operons of *Rhodobacter sphaeroides*. *Mol. Microbiol.* **71** (2009) 717-729.
4. Joshi, G. S., Romagnoli, S., VerBerkmoes, N. C., Hettich, R. L., Pelletier, D., and Tabita, F. R. Differential accumulation of form I RubisCO in *Rhodospseudomonas palustris* CGA010 under photoheterotrophic growth conditions with reduced carbon sources. *J. Bacteriol.* **191** (2009) 4243-4250

Session VII

Coordination of the Internal and External Chloroplast Division Complexes by ARC6 and PARC6

Katherine W. Osteryoung, Principal Investigator

Dept. of Plant Biology, 166 Plant Biology Bldg., Michigan State University, East Lansing, MI 48824
Email osteryou@msu.edu; website <http://plantbiology.msu.edu/faculty/faculty-research/katherine-w-osteryoung/>

Significant achievements in 2006-2009: Chloroplast division in plant cells involves the coordinated activity of the tubulin-like FtsZ ring inside the organelle and the dynamin-like ARC5 ring outside the organelle. In the previous funding period (8/2006-7/2009), we demonstrated critical roles for two proteins of the inner envelope membrane, ARC6 and PARC6, in this coordination. Using *Arabidopsis thaliana* as a model system, we showed that ARC6, which is required for FtsZ assembly (Vitha et al, 2003, Plant Cell 15: 1918–1933), is also required for the mid-plastid positioning of the outer envelope plastid division proteins PDV1 and PDV2, which have parallel functions in dynamin recruitment (Miyagishima et al, 2006, Plant Cell 18: 2517–2530). ARC6-mediated positioning of PDV2 was shown to occur via direct interaction between the intermembrane space regions of these two proteins. However, as no interaction between ARC6 and PDV1 could be detected, we hypothesized the existence of an additional factor that functions downstream of ARC6 to position PDV1. We determined that PARC6 (Paralogue of ARC6), fulfills this role. Similar to ARC6, PARC6 is an inner envelope protein with its N-terminus exposed to the stroma. PARC6 is required for PDV1 localization to the division site, but not for PDV2 localization or ARC5 recruitment. *Arabidopsis parc6* mutants exhibit chloroplast and FtsZ filament morphology defects suggesting it functions in part as an inhibitor of FtsZ ring formation *in vivo*. This activity may involve direct interaction between PARC6 and the FtsZ-positioning factor ARC3. We have proposed a working model in which ARC6 and PARC6 coordinate FtsZ and ARC5 function across the envelope membranes by antagonistically regulating FtsZ ring assembly and dynamics in the stroma and positioning PDV1 and PDV2 in the outer envelope to promote ARC5 recruitment and contractile activity (Fig. 1). In addition to establishing functions for ARC6 and PARC6 in coordinating FtsZ and ARC5 activity, we also obtained preliminary evidence of a role for ARC6 phosphorylation in the regulation of chloroplast division.

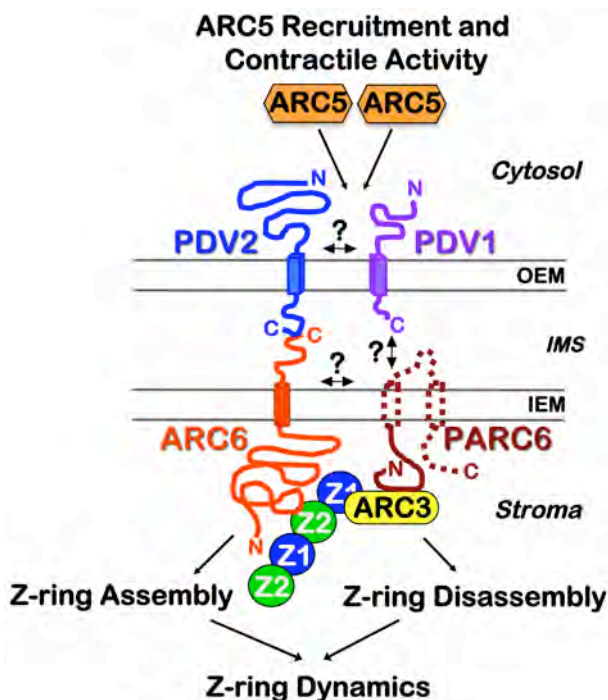

Figure 1. Working model of the coordinated chloroplast division machinery in *Arabidopsis thaliana* emphasizing the roles of ARC6 and PARC6. Formation of the stromal Z-ring, composed of FtsZ1 (Z1) and FtsZ2 (Z2), occurs first. Z-ring assembly and dynamics are antagonistically regulated by ARC6, which promotes assembly through direct interaction with FtsZ2, and PARC6, which promotes FtsZ disassembly through ARC3. Once the Z-ring is established, direct interaction between ARC6 and PDV2, possibly regulated by ARC6 phosphorylation, positions PDV2 at the division site. ARC6 also mediates PARC6-dependent positioning of PDV1. PDV1 and PDV2 recruit ARC5 independently from the cytosol to the division site, though both PDV1 and PDV2 are required for full ARC5 contractile activity. Dashed lines emphasize regions of PARC6 whose topology remains uncertain. Double-sided arrows with question marks indicate protein-protein interactions not yet demonstrated. Many aspects of this model remain to be elucidated. IEM, inner envelope membrane; OEM, outer envelope membrane; IMS, intermembrane space; N, N-terminus; C, C-terminus. Adapted from Glynn et al., 2009.

Overall goals of the current project: Based on the data described above, we proposed to further define the roles of ARC6 and PARC6 in plastid division by: 1) defining the region(s) of ARC6 required for ARC6-PDV2 interaction and PDV2 positioning, 2) testing the hypothesis that ARC6-PDV2 interaction is regulated by phosphorylation of ARC6, and 3) dissecting the role of PARC6 in plastid division by establishing its complete topology, investigating its interactions with ARC3, ARC6, PDV1 and other plastid division proteins, and studying its role in FtsZ assembly. These experiments will advance our understanding of the fundamental mechanisms underlying the assembly and coordinated activity of the chloroplast division complex in plants.

Experimental objectives for 2009-2010:

- Determine the minimum portion of ARC6 required for interaction with PDV2 using two hybrid and pull-down assays.
- Test whether the predicted ARC6 phosphorylation site is a phosphoacceptor using *in vitro* methods.
- Definitively establish the topology of PARC6 in the inner envelope membrane. This is essential for designing interaction assays between PARC6 and other division proteins.
- Determine whether PARC6 interacts directly with ARC6 and through which regions. This will be important for understanding the mechanism by which ARC6 affects PARC6 function.
- Determine whether PARC6 interacts directly with PDV1.
- Begin defining the regions of ARC3 required for its interaction with PARC6.
- Begin testing whether the stromal domain(s) of PARC6 interact with several other stromal proteins thought to regulate FtsZ ring assembly and dynamics in concert with ARC3, including MinD, MinE, and the recently identified MCD1 (Nakanishi et al., 2009, Curr. Biol. 19: 151-156). We will also test whether MCD1 interacts with ARC6 as this has not yet been determined.
- Initiate a series of genetic analyses to understand the *in vivo* significance of interactions defined in the above experiments.

Publications resulting from the 2006-2009 funding:

- Glynn J. M., Y. Yang, S. Vitha, A.J. Schmitz, M. Hemmes, S. Miyagishima, and K.W. Osteryoung. 2009. PARC6, a novel chloroplast division factor, influences FtsZ assembly and is required for recruitment of PDV1 during chloroplast division in Arabidopsis. *Plant J.* 59: 700-711.
- Yang, Y., J.M. Glynn, B.J.S.C. Olson, A.J. Schmitz, and K.W. Osteryoung. 2008. Plastid division: across time and space. *Curr. Opin. Plant Biol.* 11: :577-584.
- Glynn, J. M., J.E. Froehlich and K.W. Osteryoung. 2008. *Arabidopsis* ARC6 coordinates the division machineries of the inner and outer chloroplast membranes through interaction with PDV2 in the intermembrane space. *Plant Cell* 20: 2460-2470.
- McAndrew, R.S., B.J.S.C. Olson, C.L. Chi-Ham, S. Vitha, J.E. Froehlich and K.W. Osteryoung. 2008. In vivo quantitative relationship between plastid division proteins FtsZ1 and FtsZ2 and identification of ARC6 and ARC3 in a native FtsZ complex. *Biochem. J.* 412: 367-378.
- Glynn, J. M., S. Miyagishima and K.W. Osteryoung. 2007. Structure and dynamics of the chloroplast division complex. *Traffic* 8:451-561.

Regulation of Chloroplast Biogenesis: the *immutans* Variegation Mutant of Arabidopsis

Steve Rodermel, Principal Investigator

Department of Genetics, Development and Cell Biology

Iowa State University, Ames, IA 50011

Email: rodermel@iastate.edu

Web: <http://www.public.iastate.edu/~rodermel/labpage/homepage.html>

Overall research goals: The *Arabidopsis immutans* (*im*) variegation mutant has green-and white sector leaves due to lack of IMMUTANS (IM), a terminal oxidase in plastid membranes (also called PTOX) that bears homology to the mitochondrial inner membrane alternative oxidase (AOX). The project has three research aims: a) to elucidate the mechanism of *im* variegation; b) to examine structure/function relationships of IM and AOX; and c) to determine whether IM functions as a “safety valve” in photosynthetic electron transport. These studies should provide insight into the regulation of IM activity, and the role of IM in photosynthesis, chloroplast biogenesis, and plant growth/development. In addition, because the green and white sectors of *im* have a uniform genotype (*im/im*), research directed toward understanding the mechanism of variegation should lead to the identity of factors or processes that are able to compensate for a lack of IM in the green sectors of the mutant.

Significant achievements 2007-2009:

Aluru et al., 2007, 2009: Morphological, biochemical, molecular and microarray analyses have been carried out on the green and white sectors of *im*. The green leaf tissues have significantly higher rates of photosynthesis and sucrose production than wild type leaves, and these increases appear to be due to sink demand from the white tissues. The green tissues also have alterations in gene expression and morphology that are consistent with adaptations to photooxidative stress early in leaf development, when chloroplasts develop from proplastids. Retrograde (chloroplast –to–nucleus) signaling likely plays a role in development of the two types of leaf tissues and in optimizing interactions between them.

Fu et al., 2009: IM (PTOX) and AOX are members of the diiron carboxylate quinol oxidase (DOX) class of proteins, and they contain 20 highly-conserved amino acids, six of which are Fe-binding ligands. In previous structure/function studies, *in vitro* and *in planta* activity assays were used to examine the functional importance of the Fe-binding sites (Fu et al., 2005; *J. Biol. Chem.* 280: 42489-42496). These assays have been extended to the 14 other conserved sites, and it was observed that they fall into three classes: sites that are dispensable for activity; essential for activity; and important but not essential for activity. The data are consistent with the proposed role of some of these residues in active site conformation, substrate binding and/or catalysis.

Fu et al. 2009: It is thought that PTOX and AOX diverged from a common eubacterial ancestor several billion years ago, prior to the evolution of eukaryotic cells and the endosymbiotic events that gave rise to mitochondria and chloroplasts. Although AOX and PTOX have structurally-similar active site domains, they differ with respect to the

presence of other structural features, substrate specificities and modes of regulation. Re-targeting of AOX to *im* plastids rescues the variegation phenotype of the mutant, indicating that AOX can functionally compensate for a lack of PTOX. Domain-swapping experiments showed that some AOX constructs are better able than others to complement the *im* defect. These data demonstrate that respiratory and photosynthetic electron transport chain components are interchangeable in eukaryotic cells.

Science objectives for 2009-2010:

- To gain insight into the mechanism of *im* variegation, suppressor screens have been carried out using EMS and T-DNA tagging mutagenesis. Two suppressor lines have been identified -- one from each mutagenesis procedure. Efforts over the coming year will focus on cloning the suppressor genes and characterizing the suppressor lines (double mutants). Single mutants (in which the suppressor gene has been crossed away from *im*) will also be isolated and characterized. These experiments should identify factors/processes that are able to compensate for a lack of IM.
- Work will continue to test whether IM acts as a “safety valve” in photosynthesis. Prior experiments have shown that IM does not act as a safety valve in *Arabidopsis* during steady state photosynthesis (Rosso et al., 2006; *Plant Physiol.* 142: 574-585); the current experiments focus on early chloroplast biogenesis using *Arabidopsis* de-etiolation as a model system. This work is being carried out as part of a long term collaboration with Norm Huner’s group at Western Ontario University; they are specialists in fluorescence techniques to monitor photosynthesis.

References to work supported by this project 2007-2009:

1. Aluru, M.R., D.J. Stessman, M.H. Spalding and S.R. Rodermel. 2007. Alterations in photosynthesis in *Arabidopsis* lacking IMMUTANS, a chloroplast terminal oxidase. **Photosynthesis Research** 91: 11-23.
2. Lee, E.K., D. Cook, H. Hofmann, M. Aluru and S. Rodermel. 2007. The ProbeR Package (software) <http://cran.r-project.org/doc/packages/ProbeR.pdf>
3. Yu, F., A. Fu, M. Aluru, S. Park, Y. Xu, H. Liu, X. Liu, A. Foudree, M. Nambogga and S. Rodermel. 2007. Variegation mutants and mechanisms of chloroplast biogenesis. **Plant Cell & Environment** 30: 350-365. (Refereed review) (Cover Article).
4. Aluru, M.R., J. Zola, A. Foudree and S.R. Rodermel. 2009. Chloroplast photooxidation-induced transcriptome reprogramming in *Arabidopsis immutans* white leaf sectors. **Plant Physiol.** 150: 1-20.
5. Rosso, D., R. Bode, W. Li, M. Krol, S.R. Rodermel, D.P. Maxwell and N.P.A. Hüner. 2009. Redox control of leaf variegation and chloroplast biogenesis in *Arabidopsis thaliana*. In **Photosynthesis in the Global Perspective - Overviews and Recent Progress** (IK International Publishers, New Delhi) (in press).
6. Fu, A. M. Aluru and S.R. Rodermel. 2009. Conserved active site sequences in *Arabidopsis* plastid terminal oxidase (PTOX). **J. Biol. Chem.** (in press)
7. Fu, A., F. Yu and S. Rodermel. 2009. Translocation of a mitochondrial protein to the chloroplast: functional substitution of PTOX by AOX. **Proc. Natl. Acad. Sci.** (accepted).

*Index of Authors
and List of Participants*

Author Index

Antipov, S.	67	Holten, D.	97
Balashov, S.P.	89	Hotto, A.	69
Barta, C.	107	Huser, T.	41
Batista, S.	23	Hwang, S.-k.	95
Bender, C.	65	Inoue, K.	39
Benning, C.	63	Jankowiak, R.	73
Blankenship, R.E.	33, 97	Jung, H.S.	61
Bricker, T.M.	75	Kappell, A.	99
Britt, R.D.	41	Keegstra, K.	79
Brooks, M.	59	Kern, J.	27
Bruce, D.	23	Kim, B.-H.	37
Brudvig, G.W.	7	Kim, H.	81
Brune, D.	21	Kim, I.	65
Bryant, D.A.	3, 81	Kim, K.	77
Burnap, R.L.	99	King, P.W.	77
Carrick, M.	99	Kirmaier, C.	97
Chang, C.	77	Knaff, D.B.	83
Chang, K.	11	Kramer, D.M.	47
Chen, L.X.	19, 65, 67	Kumar, A.	107
Chory, J.	61	Kumar, T.K.S.	85
Chung, J.-S.	83	Lagarias, J.C.	41
Crofts, A.R.	91	Laible, P.D.	97
Daldal, F.	93	Lakshmi, K. V.	9
Daley, S.M.E.	99	Lange, B.M.	49
Dikanov, S.	91, 103	Lanyi, J.K.	89
Ecker, J.R.	11	Larsen, D.	41
Endow, J.	39	Li, H.	81
Fleming, G.R.	59	Li, Z.	59
Frankel, L.K.	75	Liu, H.	75
Frese, R.N.	35	Lockard, J.V.	19, 65
Froehlich, J.E.	79	Longstreth, D.	75
Furtak, T.	77	Mackenzie, S.	45
Gao, Y.	7	Malcolm, N.	75
Gennis, R.B.	91, 103	Maresca, J.A.	81
Ghirardi, M.L.	31, 77	McCusker, J.K.	53
Goforth, R.L.	85	McDermott, A.	71
Golbeck, J.H.	101	Meeks, J.C.	41
Grahm, C.	75	Meyerowitz, E.	13
Gunner, M.	23	Middleton, L.	75
Gust, D.	77	Milikisiyants, S.	9, 19, 67
Hamad, S.W.	21	Moellering, E.R.	63
Hamel, P.	31	Moore, A. L.	77
Hanson, D.K.	97	Moore, T. A.	77
Hartzler, D.	81	Mulfort, K.	65
Harvilla, P.	71	Murthy, N.	31
Heben, M. J.	77	Nair, S.	103
Henry, R.L.	85	Neff, M.M.	17
Hirasawa, M.	83	Niederman, R.A.	35

Niyogi, K.K.	59	Woronowicz, K.	35
Ntefidou, M.	5	Wraight, C.A.	91
Ogilvie, J.P.	55	Xu, C.	63
Okita, T.W.	95	Yachandra, V.K.	27
Osteryoung, K.W.	111	Yang, Z.	43
Pakrasi, H.B.	51	Yano, J.	27
Peers, G.	59	Yao, C.	21
Perez, J.	61	Zhang, S.	75
Peters, J.W.	29	Zhao, J.	17
Pires, E.	61		
Poluektov, O.G.	9, 19, 65, 67		
Portis, Jr., A.R.	105		
Posewitz, M.	31		
Pushkar, Y.	27		
Qiu, J.	17		
Redding, K.E.	103		
Rienstra, C.	105		
Rodermel, S.	113		
Roose, J.	75		
Ruppel, N.	39		
Salvucci M.E.	105		
Sauer, K.	1, 27		
Savikhin, S.	81		
Schaller, G.E.	25		
Seibert, M.	57, 73		
Sharwood, R.	69		
Shinopoulos, K.	7		
Shipman-Roston, R.	39		
Sineshchekov, O.A.	5		
Spalding, E.P.	15		
Spann, K.	75		
Spudich, J.	5		
Stern, D.B.	69		
Street, I.	17		
Tabita, F.R.	109		
Tao, N.J.	77		
Tekavec, P.	55		
Theg, S.M.	87		
Tiede, D.M.	9, 19, 65, 67		
Truong, T.	59		
Turner, G.	49		
Utschig, L.M.	19, 65, 67		
Verissimo, A.	93		
Vermaas, W.F.J.	21		
Vincill, E.	15		
von Arnim, A.G.	37		
Voo, S.S.	49		
Ward, J.	17		
Wasielewski, M.	73		
Wiederrecht, G.	65		
Woodson, J.	61		

Participants

Paul Adams
Lawrence Berkeley Lab
BLDG 64R0121
1 Cyclotron Road
Berkeley, CA 94720
Email: PDAadams@lbl.gov
Phone: 510-486-4225

Christoph Benning
Michigan State University
Biochemistry 215
East Lansing, MI 48824
Email: benning@msu.edu
Phone: 517-355-1609

Terry Bricker
Louisiana State University
Department of Biological Sciences
Baton Rouge, LA 70803
Email: tbric@lsu.edu
Phone: 225 578-1555

Donald Bryant
The Pennsylvania State University
Dept. of Biochemistry and Molecular Biology
S-235 Frear Bldg.
University Park, PA 16802
Email: dab14@psu.edu
Phone: 814-865-1992

Joanne Chory
The Salk Institute for Biological Studies
10010 North Torrey Pines Road
La Jolla, CA 92037
Email: chory@salk.edu
Phone: 858-552-1148

M. Fevzi Daldal
University of Pennsylvania
Department of Biology
103B Lynch Building
Philadelphia, PA 19104
Email: fdaldal@sas.upenn.edu
Phone: 215-898-4394

Joseph Ecker
The Salk Institute
10010 North Torrey Pines Road
La Jolla, CA 92037
Email: ecker@salk.edu
Phone: 858-453-4100 ext. 1752

Kristin Balder-Froid
Lawrence Berkeley National Laboratory
#1 Cyclotron Road
MS: 50A-4119
Berkeley, CA 94720
Email: KHBalder-Froid@lbl.gov
Phone: 510-486-6060

Robert Blankenship
Washington University in St. Louis
Dept. of Biology
Campus Box 1137
St. Louis, MO 63130
Email: blankenship@wustl.edu
Phone: 314 935-7971

Gary Brudvig
Yale University
Department of Chemistry
P.O. Box 208107
New Haven, CT 06520
Email: gary.brudvig@yale.edu
Phone: 203-432-5202

Robert Burnap
Oklahoma State University
Microbiology & Molecular Genetics
307 Life Sciences East
Stillwater, OK 74078
Email: rob.burnap@okstate.edu
Phone: 405-880-3683

Asaph Cousins
Washington State University
School of Biological Sciences
Pullman, WA 93843
Email: acousins@wsu.edu
Phone: 509-335-7218

Sergei Dikanov
University of Illinois
Department of Veterinary Clinical Medicine
506 S. Mathews Av.
Urbana, IL 61801
Email: dikanov@illinois.edu
Phone: 217-333-3776

Robert Gennis
University of Illinois
Department of Biochemistry
MC-712
Urbana, IL 61801
Email: r-gennis@illinois.edu
Phone: 217-333-9075

Participants

Maria Ghirardi
National Renewable Energy Laboratory
1617 Cole Blvd.
Golden, CO 80401
Email: maria_ghirardi@nrel.gov
Phone: 303-384-6312

John Golbeck
The Pennsylvania State University
310 South Frear Laboratory
University Park, PA 16802
Email: jhg5@psu.edu
Phone: 814-865-1163

Richard Greene
DOE Office of Science
19901 Germantown Road
Germantown, MD 20874
Email: Richard.Greene@science.doe.gov
Phone: 301-903-6190

Marilyn Gunner
City College of New York
Physics Department
160 Convent Ave, J-419
New York, NY 10031
Email: gunner@sci.ccnycunyu.edu
Phone: 212-650-5557

Deborah Hanson
Argonne National Laboratory
9700 S. Cass Avenue
Lemont, IL 60439
Email: dkhanson@anl.gov
Phone: 630-252-4189

Ralph Henry
University of Arkansas
601 SCEN, 1 University of Arkansas
Fayetteville, AR 72701
Email: ralph.henry@uark.edu
Phone: 479-283-0154

Dewey Holten
Washington University in St. Louis
Chemistry Department
One Brookings Drive
St. Louis, MO 63130
Email: holten@wustl.edu
Phone: 314-935-6502

Kentaro Inoue
University of California, Davis
One Shields Avenue
Davis, CA 95616
Email: kinoue@ucdavis.edu
Phone: 530-752-7931

Ryszard Jankowiak
Kansas State University
213 CBC Bldg.
Manhattan, KS 66505
Email: ryszard@ksu.edu
Phone: 785-532-6785

Kenneth Keegstra
Michigan State University
MSU-DOE Plant Research Laboratory
East Lansing, MI 48824
Email: keegstra@msu.edu
Phone: 517-353-7874

Paul King
National Renewable Energy Laboratory
1617 Cole Boulevard, MS 3313
Golden, CO 80401
Email: paul.king@nrel.gov
Phone: 303-384-6277

David Knaff
Texas Tech University
Dept. of Chemistry and Biochemistry
Lubbock, TX 79409
Email: david.knaff@ttu.edu
Phone: 806-742-0288

David Kramer
Washington State University
Institute of Biological Chemistry
339 Clark Hall MC-6340
Pullman, WA 99164
Email: dkramer@wsu.edu
Phone: 509-335-4964

J Clark Lagarias
University of California, Davis
Department of Molecular and Cellular Biology
One Shields Ave
Davis, CA 95616
Email: jclagarias@ucdavis.edu
Phone: 530-752-1865

Participants

KV Lakshmi
Rensselaer Polytechnic Institute
Department of Chemistry & Chemical Biology
RPI, 110 8th Street
Troy, NY 12180
Email: lakshk@rpi.edu
Phone: 518-276-3271

Janos Lanyi
University of California, Irvine
70 Whitman Ct
Irvine, CA 92617
Email: jklanyi@uci.edu
Phone: 949-824-7150

Diane Marceau
Department of Energy
170 Poinsett Lane
Frederick, MD 21702
Email: diane.marceau@science.doe.gov
Phone: 301-903-0235

Ann McDermott
Columbia University
3000 Broadway, MC 3113
New York, NY 10027
Email: aem5@columbia.edu
Phone: 212-854-8393

Elliot Meyerowitz
California Institute of Technology
1200 E. California Blvd.
M/C 156-29 Biology
Pasadena, CA 91125
Email: meyerow@caltech.edu
Phone: 626-429-8625

Michael Neff
Washington State University
Department of Crop and Soil Sciences
P.O. Box 646420
Pullman, WA 99164
Email: mmneff@wsu.edu
Phone: 509-335-7705

Kris Niyogi
University of California and Lawrence
Berkeley National Laboratory
111 Koshland Hall
Berkeley, CA 94720
Email: niyogi@nature.berkeley.edu
Phone: 510-643-6602

Bernd Markus Lange
Washington State University
Institute of Biological Chemistry
Clark Hall
Pullman, WA 99163
Email: lange-m@wsu.edu
Phone: 509-335-3794

Sally Mackenzie
University of Nebraska
N305 Beadle Center
Lincoln, NE 68588
Email: smackenzie2@unl.edu
Phone: 402-472-6997

James McCusker
Michigan State University
Department of Chemistry
East Lansing, MI 48824
Email: jkm@chemistry.msu.edu
Phone: 517-355-9715 ext.106

Gail McLean
DOE BES
SC-22.1 Germantown Building
1000 Independence Ave, SW
Washington, DC 20585
Email: Gail.McLean@science.doe.gov
Phone: 301-903-7807

Manjunatha Narayana murthy
National Renewable Energy Laboratory
1617 Cole Blvd
Golden, CO 80401
Email: manjunatha_narayana_murthy@nrel.gov
Phone: 303-384-7847

Robert Niederman
Rutgers University/New Brunswick
Dept. of Mol. Biol. & Biochem.
Nelson Bio. Labs., 604 Allison Rd.
Piscataway, NJ 08854
Email: rniederm@rci.rutgers.edu
Phone: 732-445-3985

Jennifer Ogilvie
University of Michigan
450 Church St
Ann Arbor, MI 48109
Email: jogilvie@umich.edu
Phone: 734-615-0485

Participants

Tom Okita
Washington State University
Institute of Biological Chemistry
Pullman, WA 99164
Email: okita@wsu.edu
Phone: 509-335-3391

Katherine Osteryoung
Michigan State University
Dept of Plant Biology
East Lansing, MI 48824
Email: osteryou@msu.edu
Phone: 517-355-4685

Himadri Pakrasi
Washington University in St. Louis
One Brookings Dr.
St. Louis, MO 63130
Email: pakrasi@wustl.edu
Phone: 314-935-6853

John Peters
Montana State University
614 Leon Johnson Hall
Bozeman, MT 59717
Email: john.peters@chemistry.montana.edu
Phone: 406-994-7211

Oleg Poluektov
Argonne National Laboratory
9700 S. Cass Ave.
Argonne, IL 60439
Email: Oleg@anl.gov
Phone: 630-252 3546

Kevin Redding
Arizona State University
1711 S Rural Rd
Tempe, AZ 85287
Email: Kevin.Redding@asu.edu
Phone: 480-965-0136

Steve Rodermel
Iowa State University
457 Bessey Hall
Ames, IA 50011
Email: rodermel@iastate.edu
Phone: 515-294-8890

Eric Rohlfing
Office of Basic Energy Sciences, DOE
19901 Germantown Rd.
Germantown, MD 20874
Email: eric.rohlfing@science.doe.gov
Phone: 301-903-8165

Michael Salvucci
USDA/ARS/US Arid-Land Agricultural
Research Center
21881 N. Cardon Lane
Maricopa, AZ 85238
Email: mike.salvucci@ars.usda.gov
Phone: 520-316-6355

Kenneth Sauer
Lawrence Berkeley National Laboratory
LBNL MS66-200
Berkeley, CA 94720
Email: KHSauer@LBL.GOV
Phone: 510-486-4334

Sergei Savikhin
Purdue University
Department of Physics
525 Northwestern Ave
West Lafayette, IN 47907
Email: sergei@purdue.edu
Phone: 765-413-5026

George Schaller
Dartmouth College
Department of Biological Sciences
Hanover, NH 03755
Email: george.e.schaller@dartmouth.edu
Phone: 603-646-2525

Michael Seibert
National Renewable Energy Laboratory
1617 Cole Blvd.
Golden, CO 80401
Email: mike.seibert@nrel.gov
Phone: 303-384-6279

Boris Semin
National Renewable Energy Laboratory
1617 Cole Blvd
Golden, CO 80401
Email: boris.semin@nrel.gov
Phone: 303-384-7849

Participants

Edgar Spalding
University of Wisconsin
430 Lincoln Drive
Madison, WI 53706
Email: spalding@wisc.edu
Phone: 608-265-5294

John Spudich
University of Texas Medical School
Center for Membrane Biology
6431 Fannin, MSB6.130
Houston, TX 77030
Email: John.L.Spudich@uth.tmc.edu
Phone: 713-500-5473

David Stern
Boyce Thompson Institute for Plant Research
Tower Road
Ithaca, NY 14853
Email: DS28@Cornell.edu
Phone: 607-254-1306

Steven Theg
University of California, Davis
Department of Plant Biology
Davis, CA 95616
Email: smtheg@ucdavis.edu
Phone: 530-752-0624

David Tiede
Argonne National Laboratory
9700 South Cass Ave.
Argonne, IL 60439
Email: tiede@anl.gov
Phone: 630-252-3539

Willem Vermaas
Arizona State University
School of Life Sciences
PO Box 874501
Tempe, AZ 85287
Email: wim@asu.edu
Phone: 480-965-6250

Vittal Yachandra
Lawrence Berkeley National Laboratory
1 Cyclotron Road
MS: 66R0200
Berkeley, CA 94720
Email: vkyachandra@lbl.gov
Phone: 510-486-4963

Mark Spitler
Department of Energy
SC-22.1 Germantown Building
1000 Independence Ave, SW
Washington, DC 20585
Email: mark.spitler@science.doe.gov
Phone: 301-903-4568

Robert Stack
DOE BES
SC-22.1 Germantown Building
1000 Independence Ave, SW
Washington, DC 20585
Email: robert.stack@science.doe.gov
Phone: 301-903-5652

F. Robert Tabita
The Ohio State University
Department of Microbiology
484 West 12th Avenue
Columbus, OH 43210
Email: tabita.1@osu.edu
Phone: 614-292-4297

Michael Thomashow
Michigan State University-DOE Plant Research
Laboratory
Michigan State University
East Lansing, MI 48824
Email: thomash6@msu.edu
Phone: 517-355-2299

Lisa Utschig
Argonne National Laboratory
9700 S. Cass Ave.
Argonne, IL 60439
Email: utschig@anl.gov
Phone: 630-252-3544

Albrecht von Arnim
The University of Tennessee
M407 Walters Life Sciences
Knoxville, TN 37996
Email: vonarnim@utk.edu
Phone: 865-974-6206

Joyce C Yang, Ph.D.
U.S. Department of Energy, Office of EERE
Biomass Program, EE-2E/Room 5H-021
1000 Independence Ave, SW
Washington DC, 20585
Email: joyce.yang@ee.doe.gov
Phone: 202-586-8438

Participants

Zhenbiao Yang
University of California, Riverside
Dept. of Botany and Plant Sci
Riverside, CA 92521
Email: yang@ucr.edu
Phone: 951-827-7351

Junko Yano
Lawrence Berkeley National Laboratory
1 Cyclotron Rd.
Berkeley, CA 94720
Email: JYano@lbl.gov
Phone: 510-486-4366