

ENERGY MATERIALS COORDINATING COMMITTEE (EMACC)

Fiscal Year 1982

March 1983



ANNUAL TECHNICAL REPORT

**U.S. Department of Energy
Washington, D.C. 20545**

DRAFT

DOE/FE-0033

Previous No. DOE/ER-0102

ENERGY MATERIALS COORDINATING COMMITTEE (EMACC)

Fiscal Year 1982

March 1983



ANNUAL TECHNICAL REPORT

U.S. Department of Energy

TABLE OF CONTENTS

	<u>Page No.</u>
<u>INTRODUCTION</u>	1
Fiscal Year 1982 Activities	2
Materials Funding Trends in the Department of Energy	6
<u>PROGRAM DESCRIPTIONS</u>	11
- Office of Conservation and Renewable Systems	14
● Office of Building Energy Research Development	14
● Energy Conversion and Utilization Technologies	15
● Division of Energy Storage Technology - Electrochemical Storage Branch	16
● Office of Vehicle and Engine R&D	17
● Office of Industrial Programs	18
● Biomass Energy Technology Division - Biological Hydrogen Program	18
● Division of Ocean Energy Technology - Ocean Thermal Energy Conversion Program	19
● Office of Solar Energy/Photovoltaics Energy - Technology - Materials Research	20
● Wind Energy Technology Division - Large Wind Turbine Research and Technology Development	20
- Office of Defense Programs	20
● Office of Inertial Fusion - Materials Research	20
● Office of Military Applications - Materials Research	22
● Defense Waste and Byproducts Management/R&D and Byproducts Division	22
- Office of Energy Research	24
● Office of Fusion Energy (Magnetic) - Fusion Reactor Materials	24
● Office of Health and Environment Research - Physical and Technological Research	24
● Division of Materials Sciences	24
- Office of Fossil Energy	25
● Advanced Energy Conversion - Heat Engines	25
● Office of Technical Coordination, Advanced Research and Technology Development	27
● Office of Surface Coal Gasification	27

TABLE OF CONTENTS (Continued)

	<u>Page No.</u>
- Office of Nuclear Energy	29
● Office of Breeder Technology	29
● High Temperature Reactor Development Division	30
● Light Water Reactor Systems Program	30
● Office of Naval Reactors	31
● Office of Space Nuclear Projects	32
● Division of Waste Repository Deployment	32

LIST OF TABLES

	<u>Page No.</u>
I. Membership List	3
II. DOE Materials Research, Development and Engineering Support	7
III. DOE Materials Research, Development and Engineering Support	8

APPENDIXES

Page No.

OFFICE OF THE ASSISTANT SECRETARY FOR CONSERVATION
AND RENEWABLE ENERGY

A. Office of Building Energy Research and Development**	33
B. Office of Energy Systems Research with inputs for:	
- Energy Storage Division**	36
- Energy Conversion and Utilization Technologies Division**	38
C. Office of Vehicle and Engine R&D	42
D. Office of Industrial Programs**	48
E. Office of Solar Electric Technologies with inputs for:	
- Photovoltaic Energy Technology Division	50
- Wind Energy Technology Division	52
F. Office of Renewable Technology with inputs for:	
- Geothermal and Hydropower Division**	54
- Energy from Municipal Waste Division**	63
G. Office of Solar Heat Technologies**	64
H. Office of Alcohol Fuels**	71

OFFICE OF THE ASSISTANT SECRETARY FOR DEFENSE PROGRAMS

I. Office of Military Applications	72
J. Office of Defense Waste and Byproducts Management	89

OFFICE OF THE DIRECTOR FOR ENERGY RESEARCH

K. Office of Basic Energy Sciences	90
--	----

OFFICE OF THE ASSISTANT SECRETARY FOR FOSSIL ENERGY

L. Division of Advanced Energy Conversion	98
M. Office of Technical Coordination (Advanced Research and Technology Development)	105
N. Division of Surface Coal Gasification	128

** No FY 1982 Submission provided.

APPENDIXES (Continued)

Page No.

OFFICE OF THE ASSISTANT SECRETARY FOR NUCLEAR ENERGY

O. Office of Breeder Reactor Technology: Fuels and Core Materials Division	134
P. Office of Breeder Reactor Technology: Materials and Structures Program	139
Q. Office of Space Nuclear Projects	142
R. Division of Waste Repository Development	144

2

INTRODUCTION

The DOE Energy Materials Coordinating Committee (EMaCC) serves primarily to enhance coordination among the Department's materials programs and to further the effective use of materials expertise within the Department. These functions are accomplished through the exchange of budgetary and planning information among program managers and through technical meetings/ workshops on selected topics involving both DOE and major contractors. In addition, the EMaCC aids in obtaining materials - related inputs for both intra- and inter-agency compilations.

Membership in the EMaCC is open to any Department organizational unit; participants are appointed by Division or Office Directors. The current membership is listed in Table 1.

The EMACC reports to the Director of the Office of Energy Research in his capacity as overseer of the technical programs of the Department. This annual technical report is mandated by the EMACC terms of reference. In this report are described 1) EMACC activities for FY 1982; 2) a summary of materials funding in the Department from FY 1978 to the present; and 3) on-going materials programs in the Department.

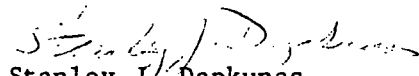
Stanley J. Dapkunas
Office of Advanced Research and
Technology
Office of Fossil Energy
Chairman of EMACC, FY 1982

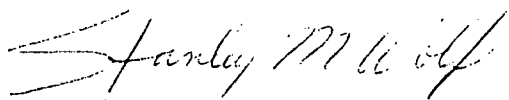
Stanley M. Wolf
Division of Materials Sciences
Office of Energy Research

Fiscal Year 1982 Activities

1. The following meetings were held:

<u>Date</u>	<u>Topic</u>	<u>Speaker</u>
Feb. 19, 1982	Materials Research for Inertial Fusion	Carl Hilland
March 19, 1982	Materials for Photovoltaic Systems	A. Scolaro
May 14, 1982	Structural Ceramics Research Funded by DOE	All Applicable
June 18, 1982	OER/BES Funded Unique User Oriented Facilities	L. Ianniello
Dec. 14, 1982	ERAB Study on Materials Research	All Applicable

2. In addition to the regular membership meetings, a special two day "EMaCC Contractors Meeting on Problems and Opportunities in Structural Ceramics" was held in Germantown on September 29 and 30, 1982. The purpose of this meeting was to apprise the user and research committees of ongoing work as well as to solicit opinions on desired research directions. Approximately 250 people attended this two day meeting.
3. EMaCC served as the mechanism of gathering input for the 1982 COMAT survey of materials research in DOE.
4. EMaCC served as a mechanism for Updating a Summary of DOE Funding in Rapid Solidification Technology (RST) for the COMAT-RST working group.
5. EMaCC provided GAO a summary of FY 82 Materials Research in DOE.

TABLE I
MEMBERSHIP LIST
DEPARTMENT OF ENERGY
ENERGY MATERIALS COORDINATING COMMITTEE
DECEMBER 1982

<u>ORGANIZATION</u>	<u>REPRESENTATIVE/ ALTERNATE</u>	<u>ROUTE SYMBOL</u>	<u>ROOM/BLDG.</u>	<u>PHONE NUMBER</u>
CONSERVATION AND RENEWABLE ENERGY				
Adv. Conservation Technology/ Electrochemical Energy Storage Advanced Technology and Assessment	Stanley S. Ruby	CE-141	5E-052/FORSTL	252-1486
	Richard T. Alpaugh	CE-131	GB-096.FORSTL	252-8055
Buildings Applications Research & Development	Ernest Freeman	CE-115	5G-050/FORSTL	252-9426
Energy Systems Research/ Energy Conversion & Utilization	James J. Eberhardt	CE-142	5E-091/FORSTL	252-1499
Industrial Programs/ Waste Products	Jerome F. Collins	CE-121.2	6G-056/FORSTL	252-2366
Heavy Duty Transport & Fuels/Office of Vehicle Engine R&D	Robert B. Schultz	CE-131	GB-096/FORSTL	252-8064
Renewable Technology/ Biomass Energy	Beverly J. Berger	CE-321	5F-043/FORSTL	252-6750
Renewable Technology/ Geothermal Energy	Leon Lehr	CE-324	5G-030/FORSTL	252-8074
Solar Energy/Ocean Energy Systems	William E. Richards	CE-331	5H-032/FORSTL	252-5517
Solar Energy/ Passive Hybrid	Lawnie Taylor	CE-312	5H-047/FORSTL	252-8103
Solar Energy/Photovoltaics	Anthony Scolaro	CE-333	5E-066/FORSTL	252-5548
Solar Energy/Wind Energy Systems/Conservation & Renewable Energies	Louis V. Divone	CE-332	5E-080/FORSTL	252-5540

TABLE I (Continued)

<u>ORGANIZATION</u>	<u>REPRESENTATIVE/ ALTERNATE</u>	<u>ROUTE SYMBOL</u>	<u>ROOM/BLDG.</u>	<u>PHONE NUMBER</u>
DEFENSE PROGRAMS Inertial Fusion/Fusion Research	Carl B. Hilland	DP-232	C-404/GTN	353-3687
Military Application/RD&T	Wm. G. Collins	DP-255.2	B-310/GTN	353-5494
Nuclear Materials Production/ Materials Processing	Louis R. Willet	DP-132	A-203/GTN	353-4959
Waste & Byproducts Management/ R&D & Byproducts	Ray D. Walton, Jr.	DP-123	A-255/GTN	353-3388
ENERGY RESEARCH Basic Energy Sciences/ Materials	Louis C. Ianniello/ Stanley M. Wolf	ER-13	J-317/GTN	353-3427
Magnetic Fusion Energy/ Development & Technology/ Materials & Radiation Effects	Gregory M. Haas/ Donald S. Beard	ER-531	J-213/GTN	353-5143
Health & Environmental Research	Gerald Goldstein	ER-74	E-223/GTN	353-5348
FOSSIL ENERGY Office of Technical Coordination	S. J. Dapkunas	FE-14	B-127/GTN	353-2748
Office of Advanced Energy Conversion	John Fairbanks	FE-22	E-138/GTN	353-2822
Office of Advanced Energy Conversion	Graham Hagy	FE-22	E-131/GTN	353-2828
Office of Advanced Energy Conversion	Dwight Shelor	FE-22	F-323	353-5910
Office of Surface Gasification	James Carr	FE-23	F-307	353-5985
Office of Coal Mining	N. L. Jensen	FE-24	C-133	353-2722

TABLE I (Continued)

<u>ORGANIZATION</u>	<u>REPRESENTATIVE/ ALTERNATE</u>	<u>ROUTE SYMBOL</u>	<u>ROOM/BLDG.</u>	<u>PHONE NUMBER</u>
NUCLEAR ENERGY				
Breeder Reactor Programs/ Breeder Technology Projects/Materials & Structures	Chester M. Purdy	NE-54	F-414/GTN	353-4486
Breeder Reactor Programs/ Breeder Technology Projects/Fuels	Andrew Van Echo	NE-53	F-421/GTN	353-3930
Breeder Reactor Programs/ Space Nuclear Projects/ Safety & Nuclear Operation	Gary L. Bennett	NE-55	E-419/GTN	353-3197
Converter Reactor Deployment High Temperature Reactor Development	J. Edward Fox	NE-15	E-478/GTN	353-4162
Converter Reactor Deployment/ Light Water Reactor Projects	Peter M. Lang	NE-14	E-451/GTN	353-3313
Naval Reactors/Reactor Materials	Robert H. Steele	NE-60	4E-38/GTN	557-5561
Support Programs/Safety Quality Assurance & Safeguards	Benjamin C. Wei	NE-74	E-427/GTN	353-3927
Terminal Waste Disposal and Remedial Action/Waste Repository Deployment	Warren K. Eister	NE-22	G-450/GTN	353-3188
Uranium Enrichment & Assessment/ Advanced Technology Projects	Robert A. Jones	NE-35	A-178/GTN	353-3933
Uranium Enrichment & Assessment/ Enrichment Expansion Projects	Arnold P. Litman	NE-34	A-188/GTN	353-5777

Materials Funding Trends in the Department of Energy

Support of materials programs from FY 1978 to the present have been compiled from prior EMACC reports and inputs to this one (primarily information for the Inventory of Materials Research and Technology in the Federal Government surveyed in FY 1982 by the OSTP Committee on Materials). It should be noted that in DOE, many materials programs are not identified as separate organization line items. The budgets indicated for these materials programs are estimates, made in some cases by different persons in different years. Thus, year-to-year comparisons can at best be qualitative. Given the above caveat, the materials budgets for FY 1978, 1979, 1980, and 1982 are summarized in Table II. Two trends are apparent. First, the total funding peaked in FY 1980, and FY 1982 funding was 10% lower before accounting for inflation. The FY 1983 DOE budget had not been established at the date of compilation of this report, but FY 1980-1982 trends were continued in FY 1983 budget estimates available. Second, the major portion of this significant decrease has been taken in the energy technology programs.

Funding of individual materials programs for FY 1978 - 1980 and FY 1982 is listed in Table III. This more detailed breakdown also attempts to show the reorganization of materials programs in this period.

TABLE II: DOE MATERIALS RESEARCH, DEVELOPMENT AND ENGINEERING SUPPORT

	FUNDING (\$ millions) FOR FISCAL YEAR ¹			
	1978	1979	1980	1982
CONSERVATION AND RENEWABLE ENERGY	36.2	76.1	47.9	38.5
DEFENSE PROGRAMS	83.6	73.9	70.2	98.6 ³
ENERGY RESEARCH	74.4	81.7	91.2	110.6
FOSSIL ENERGY	30.0	32.1	33.3	15.1
NUCLEAR ENERGY	90.0	94.2	144.8	105.5 ⁴
RESOURCE APPLICATIONS	7.0	13.2	13.8	0
TOTAL	321.1	371.8	401.2	368.3
			(459.7) ²	

1. Data from EMaCC Annual Technical Reports for FY 1978-1980 and from the COMAT Inventory for FY 1982; see note 3 also. Table III lists funding for individual materials programs.
2. The total \$459.7 in FY 1980 EMaCC Annual Technical Report includes two funding increments not given in other years. These are a) \$28.5 million in the Nuclear Waste Management program under Nuclear Energy related to waste form treatment and geologic core studies, and b) \$30.0 million in the Nuclear Materials Production program under Defense Programs related to overall system performance.
3. Modified from the COMAT Inventory to include (a) classified as well as unclassified R&D in the Office of Military Applications and (b) materials work in the Waste and Byproducts Management Division (located and reported under Nuclear Energy in FY 1978-1980).
4. Basis for comparison - FY 1980 funding of \$122.8 million (see note 3b).

TABLE III: DOE MATERIALS RESEARCH, DEVELOPMENT AND ENGINEERING SUPPORT

	FUNDING (\$ millions) FOR FISCAL YEAR ^a			
	1978	1979	1980	1982
<u>CONSERVATION AND RENEWABLE ENERGY</u>	36.2	76.1	47.9	38.5
- Conservation				
Building Energy Research & Development ^b	new in FY1979	1.1	1.3	2.1
Energy Conversion & Utilization Technologies		--	new in FY1981 --	.7
Energy Storage Technology ^c	5.9	10.4	8.9	1.8
Industrial Programs ^d	1.0	1.7	3.1	0.3
Vehicle and Engine R&D		11.2	10.1	10.2
		new in FY1979		
- Solar				
Biomass Hydrogen Program	--	--	--	.1
Ocean Energy Technology ^e	4.0	4.4	.4	2.5
Photovoltaics Energy Technology ^f	24.8	47.3	24.1	20.5
Wind Energy Technology ^g	.5	0	0	.3
<u>DEFENSE PROGRAMS</u>	83.6	73.9	70.2 ^s	87.6
Inertial Fusion ^h	5.0	6.5	5.5	1.2
Military Applications ⁱ	78.6	67.4	64.7	86.4
Waste and Byproducts ^q		new in FY1982	--	11.0
<u>ENERGY RESEARCH</u>	73.3	80.7	91.2	110.3
Advanced Technology Projects	0	.4	.1	0
Fusion (magnetic)	9.3	10.4	12.9	15.8
Materials Sciences	64.0	69.9	78.0	94.5
Health & Environment ^j	1.1	1.0	.2	.3

TABLE III: DOE MATERIALS RESEARCH, DEVELOPMENT AND ENGINEERING SUPPORT

	FUNDING (\$ millions) FOR FISCAL YEAR ^a			
	1978	1979	1980	1982
<u>FOSSIL ENERGY</u>	30.0	32.1	33.3	15.1
Advanced Conversion Technology ^k	20.0	20.0	21.6	4.8
Advanced Research & Technology ^l	6.5	7.4	6.2	8.0
Magnetohydrodynamics	3.5	3.0	5.5	0
Solid Fuel Mining ^m		1.7		
Surface Coal Gasification	new in FY1982			2.3
<u>NUCLEAR ENERGY</u>	90.0	94.2	144.8	105.5
Breeder Reactor Technology ⁿ	39.0	32.0	40.7	27.4
High Temperature Reactors ^o	10.4	8.7	10.4	5.8
Light Water Reactors	new in FY1980		7.3	1.9
Naval Reactors	35.0	38.0	50.0	60.0
Space Nuclear ^p	4.6	5.5	5.8	3.5
Waste Repository Deployment ^q	1.0	10.0	30.6	6.9
<u>RESOURCE APPLICATIONS^r</u>	7.0	13.2	13.8	0
Geothermal Energy Technology	4.5	7.1	5.3	—
Electric Energy Systems	2.5	4.0	6.9	—
Uranium Resources and Enrichment	new in FY1979	2.1	1.6	—
 TOTAL	 321.1	 371.8	 401.2	 357.3

NOTES TO TABLE III

- a. Data obtained from EMaCC Annual Technical Reports for FY1978-1980 and from submissions to the Committee on Materials (COMAT) for FY1982.
- b. Building and Community Systems in FY1979-1981.
- c. Advanced Conservation Technologies in FY1980-1981.
- d. Office of Vehicle and Engine R&D in FY1979-1981.
- e. - Includes Solar Applications in FY1980 (\$.4 million).
- Part of Solar Technology in FY1978-1979.
- f. - Part of Solar Technology in FY1978-1979.
- Includes Solar Applications in FY1978 (\$6 million) and in FY1979 (\$1.1 million).
- Includes Solar Applications for Buildings and Industries in FY1980.
- Includes Passive Solar R&D FY1978-1980.
- g. Part of Solar Technology in FY1978.
- h. Laser Fusion in FY1978.
- i. FY1982-1983 estimates include classified and unclassified support.
- j. - Biomedical and Environmental Research and Environmental Control Technology in FY1978-1979.
- Under the Assistant Secretary for Environmental Protection FY1978-1980.
- k. Fuel and Coal Utilization in FY1978-1980.
- l. Coal Conversion in FY1978, Planning and Systems Engineering in FY1979.
- m. Reported for only one year as shown.
- n. Reactor Research and Technology FY1978-1980.
- o. Nuclear Power Development in FY1978-1979 Gas Cooled Reactors in FY1980-1981.
- p. Advanced Systems and Materials Production in FY1978. Advanced Nuclear Systems and Projects in FY1979-1980.
- q. - Funded Under Nuclear Energy Waste Management Program in FY1978-1980.
- High level waste transferred to Defense Programs in FY1982.
- FY1980 support of \$59.1 million given in the FY1980 EMaCC Annual Technical Report included waste form treatment and geologic core studies which were not included in this compilation.
- r. Phased out in FY1981.
- s. For FY1980 only, the Nuclear Materials Production program indicated \$30.0 million support in the FY1980 EMaCC Annual Technical Report. This work has been reevaluated as measuring system performance rather than materials properties and is not included in this total.

Program Descriptions

DOE materials programs are described in brief below based on submissions to the Committee for Materials (COMAT) and in more detail in appendices based on submissions to EMACC. Organization charts of the Department are provided to show the "location" of the various programs.

THE DEPARTMENT OF ENERGY

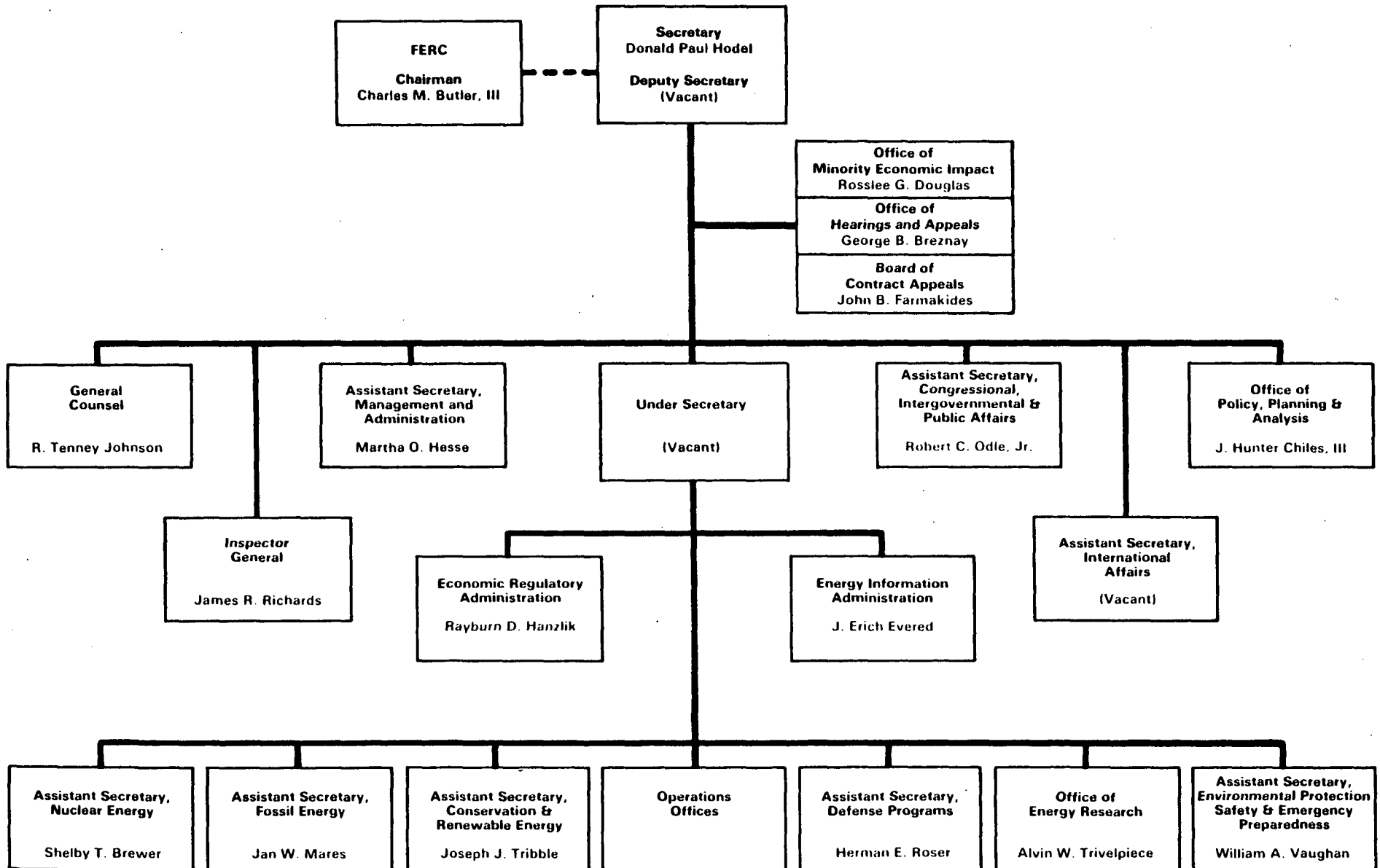

Office of the Assistant Secretary for Conservation and Renewable Energy

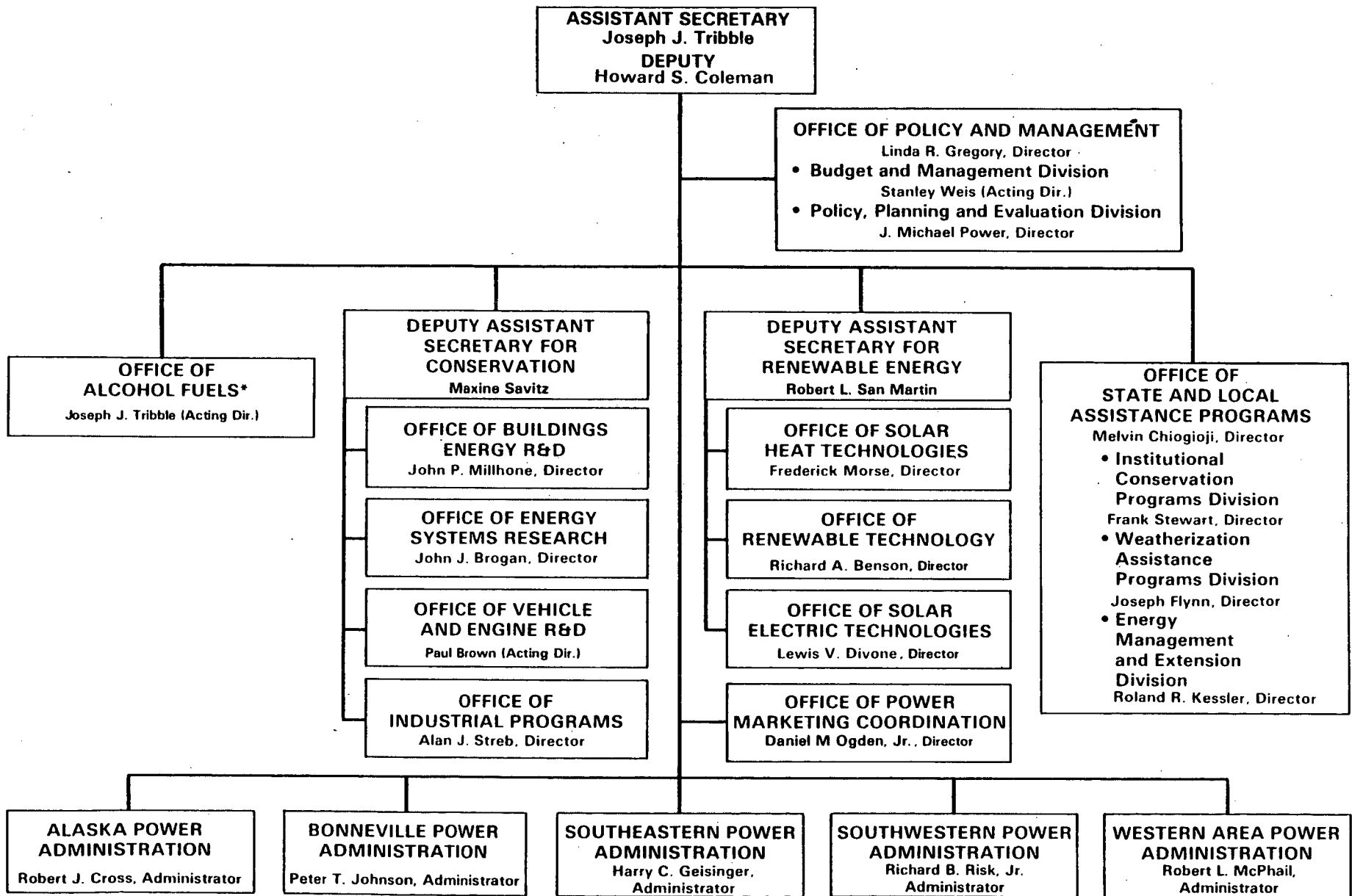

* Reports directly to the Secretary on matters relating to P.L. 96-294.

OFFICE OF CONSERVATION AND RENEWABLE SYSTEMS

Office of Building Energy Research Development

Contact/Telephone No. - Ernest Freeman/ 252-9426 for
Office of Building Energy Research
Development

- Others indicated below with specific projects.

Current applied research and development on materials includes:

- 1 - The phenomenon of Ultraviolet emissions for mercury vapor lamp gas with various isotope concentrations to improve efficiency. Experiments with various isotope concentrations are conducted to determine efficiency improvements and experiment with photoionization and photo chemical isotope separation techniques. (Contact Robert Boettner, 252-9136).
- 2 - Development of a high/low temperature advanced insulation for use in appliances and refrigeration systems. Tests and analysis of combinations of materials are performed to understand the heat transfer process occurring in thermal insulation. (Contact Ronald Fiskum, 252-9130).
- 3 - Thermodynamic effects of refrigerant mixtures in vapor compression systems - the effects of refrigerant mixtures in breadboard systems with multiple heat exchangers are investigated experimentally. (Contact R. Fiskum);
- 4 - Characterization of advanced absorption fluid pairs for use with absorption heat pumps - studies are developing a computer model for screening and identifying new fluid pairs as well as thermophysical properties data for certain fluids. (Contact - R. Fiskum).
- 5 - Corrosion data for metallic and nonmetallic materials which are candidates for use in condensing heat exchangers - starting from existing knowledge of materials corrosion properties, selected materials are systematically studied to establish their corrosion resistances to oil condensate that heat exchangers encounter in heating equipment. (Contact Danny C. Lim, 252-9130).
- 6 - Understanding of energy transport in thermal insulation through development of reliable and representative models for use by researchers - computer models are developed based on theoretical analysis and validated by experimental data. (Contact William Gerken, 252-9191).
- 7 - Development of devices, including a line-heated guarded hot plate, capable of minimizing unwanted heat flows of testing measurement strategies and edge loss calculations, and of

determining R-value for thick insulation samples - prototype units are being designed, built, and used to conduct heat transfer research, development and test studies. (Contact W. Gerken).

- 8 - Thermal and mechanical properties of insulating materials in residential applications - R&D Approach: Laboratory and field testing of insulating materials is conducted to improve understanding of their properties. (Contact W. Gerken).
- 9 - Quantitative smoldering combustion test for cellulosic insulation - a test procedure is being developed based on experimental investigation of smoldering combustion processes in cellulosic insulation. (Contact W. Gerken).
- 10 - Corrosion test applicable to all thermal insulation materials - tests are being determined based on experimental investigation of corrosive effects of insulating materials on copper, steel, and aluminum. (Contact W. Gerken).

Appendix A contains more details.

Energy Conversion and Utilization Technologies

Contact/Telephone No. - James J. Eberhardt/252-1499

The purpose of the ECUT Program is to support longer-term generic and problem solving research to develop new technologies for increasing energy productivity. Most of the materials effort addresses ceramics and polymerics. Major areas are:

- 1 - Measurements of friction coefficients and wear rates and determinations of wear mechanisms for dissimilar ceramics sliding against each other in a pin-on-disk test at temperatures up to 1200^oF. Experiments are run in air and dry nitrogen.
- 2 - Exploration of the limits of the technologies for attaching ceramics to metals and other ceramics for high temperature applications, such as advanced heat engines and high-temperature industrial heat exchangers.
- 3.- Establishing the feasibility of producing fine, high-purity, sinterable silicon carbide powders via a rotary kiln process; feed materials are carbon and SiO₂.

- 4 - Development of technologies to permit recycle or reuse of post-consumer plastic scrap by means of consolidation or separation. Present work is concentrated on bonding of plastic components of scrapped auto shreds and shredded beverage containers and on separations of beverage container plastics.
- 5 - Develop an experimentally verified model to predict the heat transfer and diffusion properties of rigid urethane foam insulation as functions of basic physical and geometric properties of the material; the intention is to indicate improvements in the material which can mitigate the deterioration with time of the materials' insulating capabilities;
- 6 - Identify commercially available plastic coatings for use on surfaces of low-cost metal heat exchanger surfaces to resist corrosive attack by sulfuric acid condensed from gaseous effluent streams below 200°C;
- 7 - Evaluation of the potential of materials such as long-ranged ordered alloys and aluminides for heat engine and steam turbine applications; and;
- 8 - Review of the current state of the art in superalloy technologies and identify any long-range generic research and development needs or opportunities for energy conservation applications; special emphasis is placed on advanced forming techniques.

Appendix B provides further details.

Division of Energy Storage Technology - Electrochemical Storage Branch

Contact/Telephone No. - Albert R. Landgrebe/252-1483

The objective of the materials research and development is to support systems work on secondary batteries and electrochemical energy conversion systems. Major materials areas are electrolyte stability under cyclic charge/discharge conditions and corrosion resistance of components.

Appendix B provides further details.

Office of Vehicle and Engine R&D

Contact/Telephone No. - Robert B. Schulz/252-8064

Structural ceramics and iron-based alloys are being developed for automotive gas turbine, Stirling and adiabatic diesel engines. The FY 1983 Budget Request is for a Ceramic Research Program (under the Energy Conversion and Utilization Technologies Program) and no heat engine development. The final FY 1983 appropriation is expected to continue the proof of concept gas turbines and Stirling engine programs. Major sub-project materials objectives in FY 1982 are:

- 1 - To evaluate the capability of commercially available ceramics materials to perform satisfactorily in automotive gas turbines and evaluate ceramic components in an existing Heavy-Duty Automotive Gas Turbine Engine, replacing existing metal parts; existing and near-term ceramic technology will be used to improve fuel economy and durability, reduce life cycle costs, and reduce strategic materials content;
- 2 - To develop an advanced gas turbine engine capable of demonstrating the DOE/NASA goals of improved fuel economy, reduced emissions, and alternative fuel capability; ceramic materials will be used for most or all of the hot-section components.
- 3 - To develop and evaluate advanced techniques for fabricating and evaluating ceramic components, including improved processing techniques for densifying reaction bonded silicon nitride for injection-molded components;
- 4 - To develop ceramic materials suitable for application in advanced heat engines, including high temperature, low-thermal-conductivity ceramic materials and transformation toughened ceramics for adiabatic engine applications;
- 5 - To develop methods of analyzing structural failure mechanisms of ceramic materials and predicting the useful life of ceramic components;
- 6 - To evaluate high temperature alloys in a simulated Stirling engine environment combining high-pressure hydrogen, high temperature, and combustion products; the effect of high-temperature aging and hydrogen exposure on the creep properties of candidate high-temperature alloys will be determined as well as the hydrogen permeability of commercial and new high temperature alloys; hydrogen "doping" as a method of reducing permeability will be investigated; and
- 7 - To develop and evaluate improved castable iron-based alloys for Stirling engine applications which will meet performance requirements and reduce both cost and strategic material usage.

Appendix C gives further details.

Office of Industrial Programs

Contact/Telephone No.- Jerome Collins/252-2366
Ralph L. Sheneman/252-2080

Industrial conservation research by DOE is performed to increase process efficiencies, reduce waste production, and utilize industrial wastes and heat forms. This research is undertaken when analysis has shown that the energy benefit is significant compared to the federal research cost; where the technical risk is high, and where the industrial sector cannot undertake the expense completely on its own. In the course of process improvements and wastes utilization, some concomitant materials development may be required as dictated by the process and wastes-oriented research.

The main materials objectives of this program are to determine the feasibility of using cement with controlled particle sized distributions in practical concrete applications, and to investigate potential energy savings that ensure from such use. Previous work on this project has demonstrated that much better use can be made of cement clinker if it is ground by a method which gives a narrower particle size distribution in the product cement. This occurs basically because the very small and very large particles found in ordinary ball milled cement are not fully utilized in the development of strength in the hydrated cement paste, which is the binding element in concrete.

Appendix D gives further details.

Biomass Energy Technology Division - Biological Hydrogen Program

Contact/Telephone No. - Carl Wallace/252-1298

The overall objective of this effort is to provide materials selection and engineering design support of the photosynthetic bacterial hydrogen production system. The most difficult materials challenge is the identification of a suitably cost-effective transparent covering for the reactors. A wide range of polymers and polymer composites have been screened to identify those few with a suitable combination of solar transmittance, low permeability to hydrogen and oxygen, high strength, resistance to photo- and bio-degradation, and low cost. These materials will be subjected to a series of durability tests after periods of exposure to realistic conditions of a reactor and evaluated according to performance and cost.

Division of Ocean Energy Technology - Ocean Thermal Energy Conversion Program

Contact/Telephone No. - M. Kim/252-6262

The materials program of the OTEC Program involves the development of a large scale cold water pipe test article and then testing it at sea. The objective is to further develop a cold water pipe technology base to reduce risk in future prototype units. The pipe is made of fiber reinforced plastic and syntactic foam.

Office of Solar Energy/Photovoltaics Energy Technology - Material Research

Contact/Telephone No.- Robert H. Annan/252-1720
Anthony Scolaro/252-5548

Materials research supports applied research on properties of photovoltaic material including screening of new materials, material interfaces, reaction kinetics and thermodynamics, defect chemistry, materials stability, etc. Major areas are:

- 1 - Polycrystalline thin film materials, specifically polycrystalline semiconductors which can be made in thin films of 10 microns or less to understand such key materials properties as defect chemistry, interface interaction and material stability and how to alter these properties to make better solar cells.
- 2 - Amorphous thin film materials, involving further development of amorphous materials for use in highly efficient multiband gap solar cells; techniques for deposition such as glow discharge, chemical vapor deposition and reactive sputtering will also be studied;
- 3 - Polycrystalline silicon cells involving study of crystal growth by novel techniques with the goal of growing defect free or defect passivated silicon sheet material, suitable for high efficiency solar cells, at high rates; also study of novel cell structures and/or processes that have the potential to improve the conversion efficiency;
- 4 - Advanced concentrator concepts such as superlattice cascade cells, and monolithic cascade cells for highly efficient solar cells. There is also considerable study of III-V semiconductor materials and luminescent concentrator materials;
- 5 - Photovoltaic electrochemical cells, centered on the semiconductor/electrolyte interface with the goal of improving collection efficiency and semiconductor stability; and
- 6 - Flat plate solar array project, which studies all elements in the formation of crystal silicon photovoltaic modules. The project's activities include the refinement to semiconductor grade of raw silicon, crystal growth, silicon sheet modification (junction formation), and coatings and films to reduce reflection and protect the cells and modules.

Wind Energy Technology Division - Large Wind Turbine Research and Technology Development

Contact/Telephone No. - Peter Goldman/252-1776

The objectives of the materials research projects is the attainment of reductions in the cost of energy from WECS (wind energy conversion systems) through testing of blades and other advanced components for large wind turbines.

Materials research currently in progress includes investigations of several properties of advanced composite materials such as wood fiber veneer/epoxy resin laminates (e.g., Douglas fir/epoxy laminates) and hybrid composites (e.g., glass and carbon fiber reinforced cement); joining methods of wood to wood composites and wood composites to steel are being developed and evaluated. Research is also being conducted on structural durability of experimental rotor sub-structures when subjected to ultra high cyclic loading (4×10^8 cycles) and extreme environmental conditions.

Appendix E provides further details.

OFFICE OF DEFENSE PROGRAMS

Office of Inertial Fusion - Materials Research

Contact/Telephone No. - Carl Hilland/353-3687

The materials effort consists of applied research and development oriented toward producing controlled thermonuclear fusion reactions in a laboratory environment for military and energy applications. The three major areas (and the materials studied therein) are:

- 1 - Laser materials and optical components (neodymium glass, metallic optical coatings, and electronic materials);
- 2 - Fusion reaction materials (ceramics, glass, carbides, carbon), metals (ferrous and nonferrous), optical materials, thermal materials, construction materials; and electronic materials; and
- 3 - Target fabrication (ceramics, glass, carbon), metals (ferrous and non-ferrous), polymers (plastics) and composites.

Office of the Assistant Secretary for Defense Programs

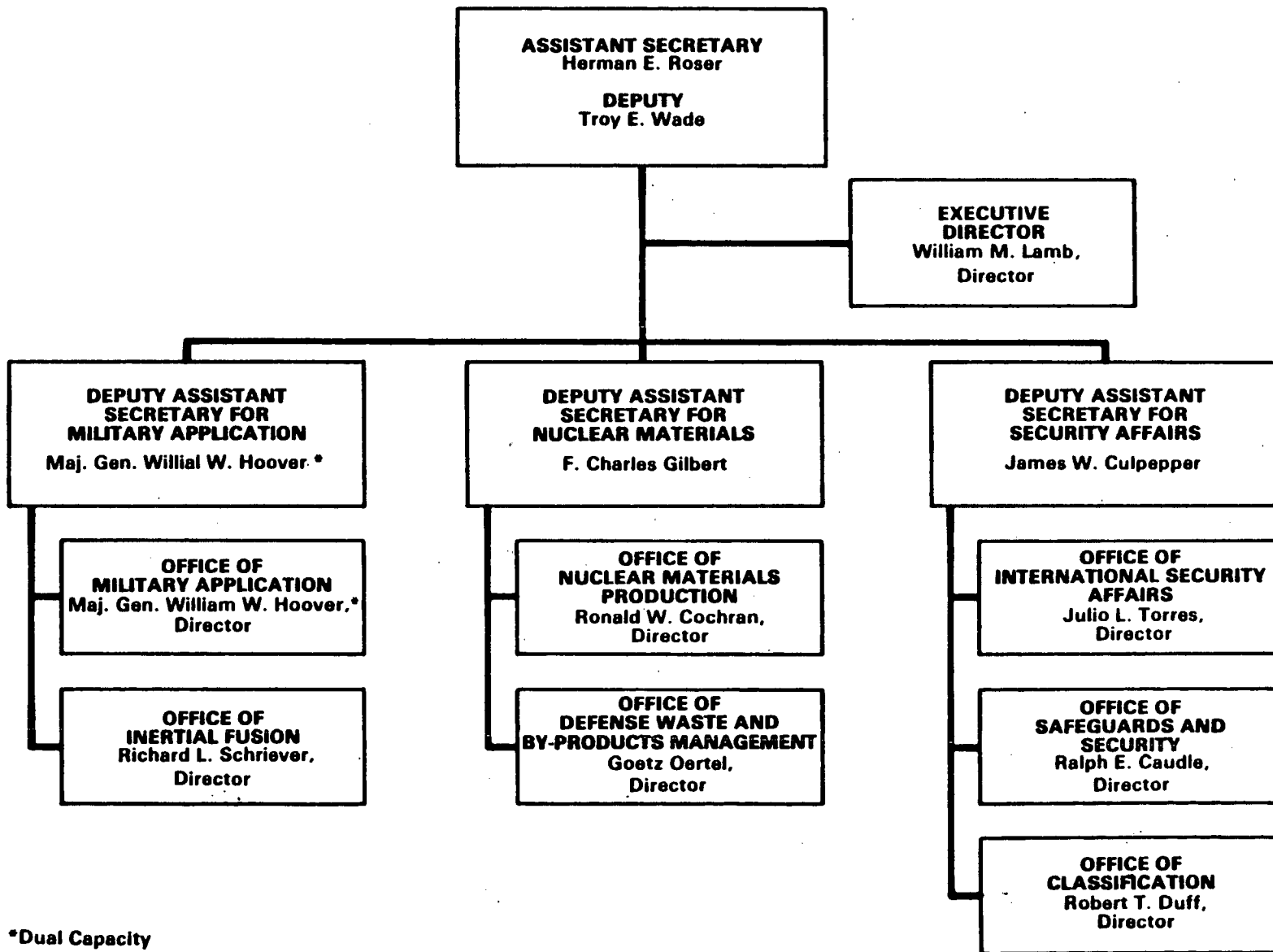

-21-

*Dual Capacity

March 1982

Office of Military Applications - Materials Research

Contact/Telephone No. - William G. Collins, Jr./353-5494

The objective of the materials research sponsored by the program is to develop materials and materials technology for national security uses. This applied research is directed toward material science, the understanding and development of advanced materials and fabrication technology, and the development of materials and processes required to produce nuclear and nonnuclear parts. Major areas are:

- 1 - Metals, metallurgy activities and superconducting and magnetic materials;
- 2 - Surface science, coating, welding and joining, fabrication, and materials compatibility;
- 3 - Ceramics, glasses and amorphous materials;
- 4 - Polymers, composite and adhesives, and
- 5 - Materials characterization techniques.

Appendix I provides further details.

Defense Waste and Byproducts Management/R&D and Byproducts Division

Contact/Telephone No. - J. J. Jicha/353-3031

The Defense Long-Term Waste Management Technology program is directed toward implementation of long-term management of DOE radioactive waste. It includes materials development and evaluation for high-level and transuranic waste forms and canisters. Alternative waste forms and compositions are being developed and characterized. This is primarily done with simulated, non-radioactive waste on a laboratory scale. Characterization tests include chemical durability, radiation stability, thermal stability, and mechanical properties. Processes are also being developed to produce alternative waste forms incorporating high-level radioactive waste. Both lab scale radioactive and engineering scale nonradioactive studies are included. Waste forms include glasses and polycrystalline ceramics.

Appendix J provides further detail.

Office of Energy Research

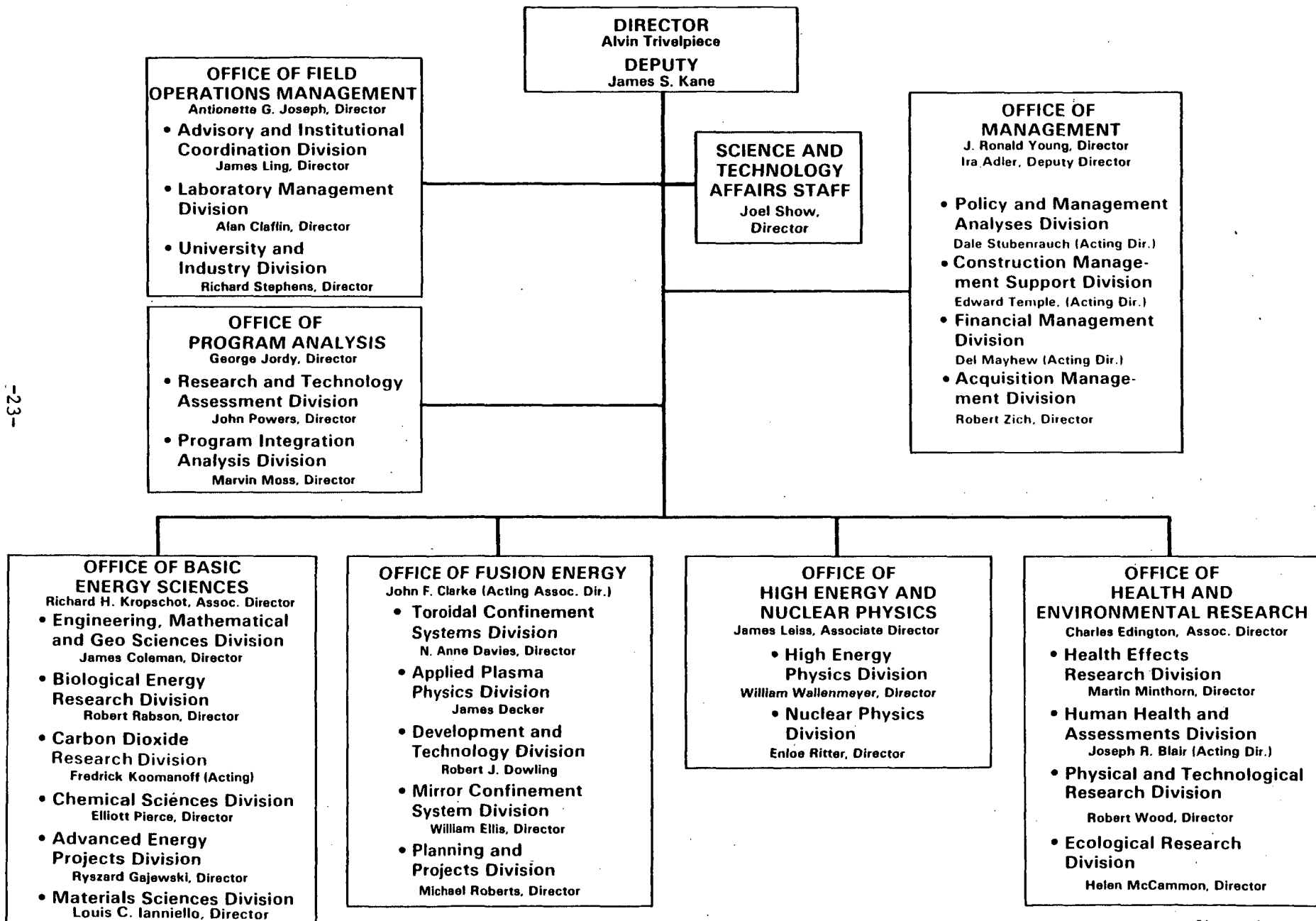

-23-

OFFICE OF ENERGY RESEARCH

Office of Fusion Energy (Magnetic) - Fusion Reactor Materials

Contact/Telephone No. - G.M. Haas/353-5143

The research and development on materials addresses needs of magnetic fusion systems and future fusion reactors. The general objective is to provide the materials property data base and where necessary to develop new materials for the design, construction, and operation of fusion reactor systems.

Office of Health and Environmental Research - Physical and Technological Research

Contact/Telephone No. - Gerald Goldstein/353-5348

Develop the basic technology of semiconductory radiation detectors, detector materials, and associated electronics required for many types of radiation measurement in physics, biological and environmental research.

Division of Materials Sciences

Contact/Telephone No. - Louis Ianniello/353-3427

The aim of this basic research program is to increase the understanding of materials phenomena, materials properties and behavior of classes of materials important to the Department of Energy's missions. Some of the research is specific to one energy technology (e.g., photovoltaic phenomena for solar energy conversion), some is related to many energy technologies simultaneously (e.g., hydrogen embrittlement) while still other research is aimed at long range advancement of materials science (e.g., neutron scattering). In the pursuit of these objectives, new forefront instruments and facilities are developed as needed. It is recognized that this program carries a major responsibility for many of the nation's premier research facilities including several neutron sources, a synchrotron radiation source and frontier electron microscopes. The research is conducted at DOE laboratories, universities, and to a lesser extent at industrial laboratories by metallurgists, ceramists, solid state physicists and materials chemists in about 100 different institutions. There are three subprograms:

- 1 - Metallurgy and Ceramics: To understand better how metallic and ceramic materials behavior/properties are related and controlled by structure and processing conditions;

- 2 - Solid State Physics: Directed toward fundamental research on matter in the condensed state, wherein the interactions of electrons, atoms, and defects are tracked with the purpose of determining the critical properties of solids; and
- 3 - Materials Chemistry: Developing an understanding of the chemical properties of materials as determined by their composition, structure, and environment (pressure, temperature, etc.) and to show how the laws of chemistry may be used to understand physical as well as chemical properties and phenomena.

Appendix K gives further details, as does the DOE publication, Materials Sciences Programs Fiscal Year 1982 (DOE/ER-0143 dated September 1982).

OFFICE OF FOSSIL ENERGY

Advanced Energy Conversion-Heat Engine

Contact/Telephone No. - John W. Fairbanks/353-2822

The materials effort emphasizes engineering to improve materials for industrial/utility gas turbine and diesel engine hot-section components to provide efficient, durable, environmentally acceptable operation with coal base fuels. Development of new materials is focused on adherent corrosion resistant oxide ceramic coatings such as zirconia and alumina. Silicon carbide and silicon nitride are also being evaluated. The effect of coating process modifications, such as substantial surface preparation, plasma deposition, and laser heating of the coating, are being examined. Also, to support the water cooled gas turbine engine capability to operate with coal base fuels, materials work on vane and blade materials and fabrication is being conducted to determine the strength of powder metallurgically produced and directionally solidified metallic alloys.

Appendix L provides further details.

Office of the Assistant Secretary for Fossil Energy

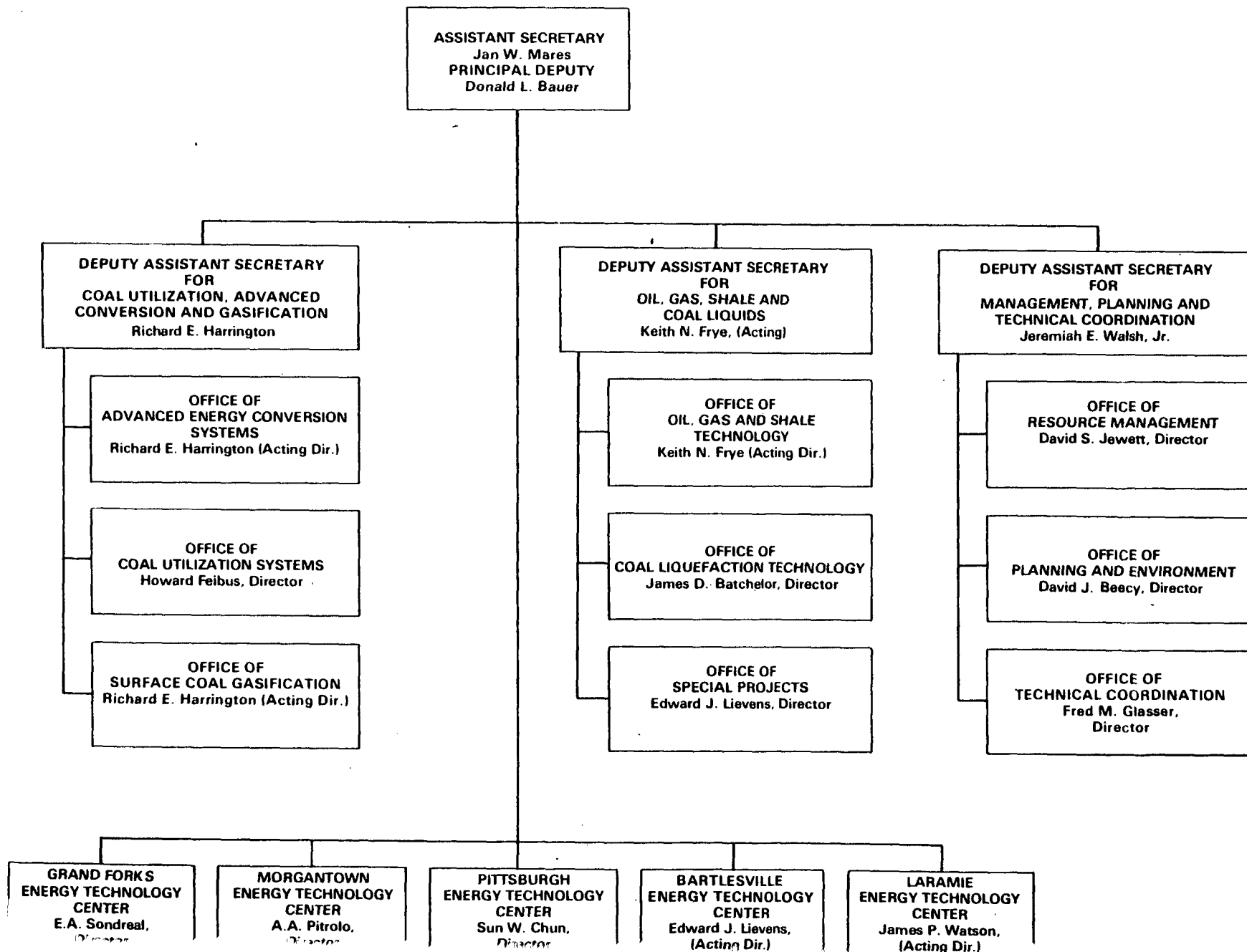

Office of Technical Coordination -Advanced Research and Technology Development

Contact/Telephone No. - S.J. Dapkunas/353-2784

The objective of this program is to develop a broad, generic technology base in structural materials used in fossil fuel conversion systems such as coal gasification, liquefaction and combustion and shale processing. Major areas include:

- 1 - High temperature corrosion and erosion of ferrous and non-ferrous alloys;
- 2 - Corrosion and fracture of structural ceramics such as silicon carbide and silicon nitride;
- 3 - Deterioration of oxide refractories under gaseous and slagging conditions; and
- 4 - Reliability of pressure vessel low alloy steels.

Appendix M provides further details.

Office of Surface Coal Gasification

Contact/Telephone No. - James Carr/353-5985

The materials program objectives are to develop and apply appropriate materials to coal gasification plants/components, vessels and piping systems. The overall goal is to improve the operational reliability, system durability and to reduce fabrication as well as operating costs of coal gasification plant constituent elements and/or components operating under high temperature, erosive, corrosive, dirty environment conditions. Materials being evaluated include structural ceramics, coatings and claddings, refractories, high strength metal alloys.

Appendix N provides more details.

Office of the Assistant Secretary for Nuclear Energy

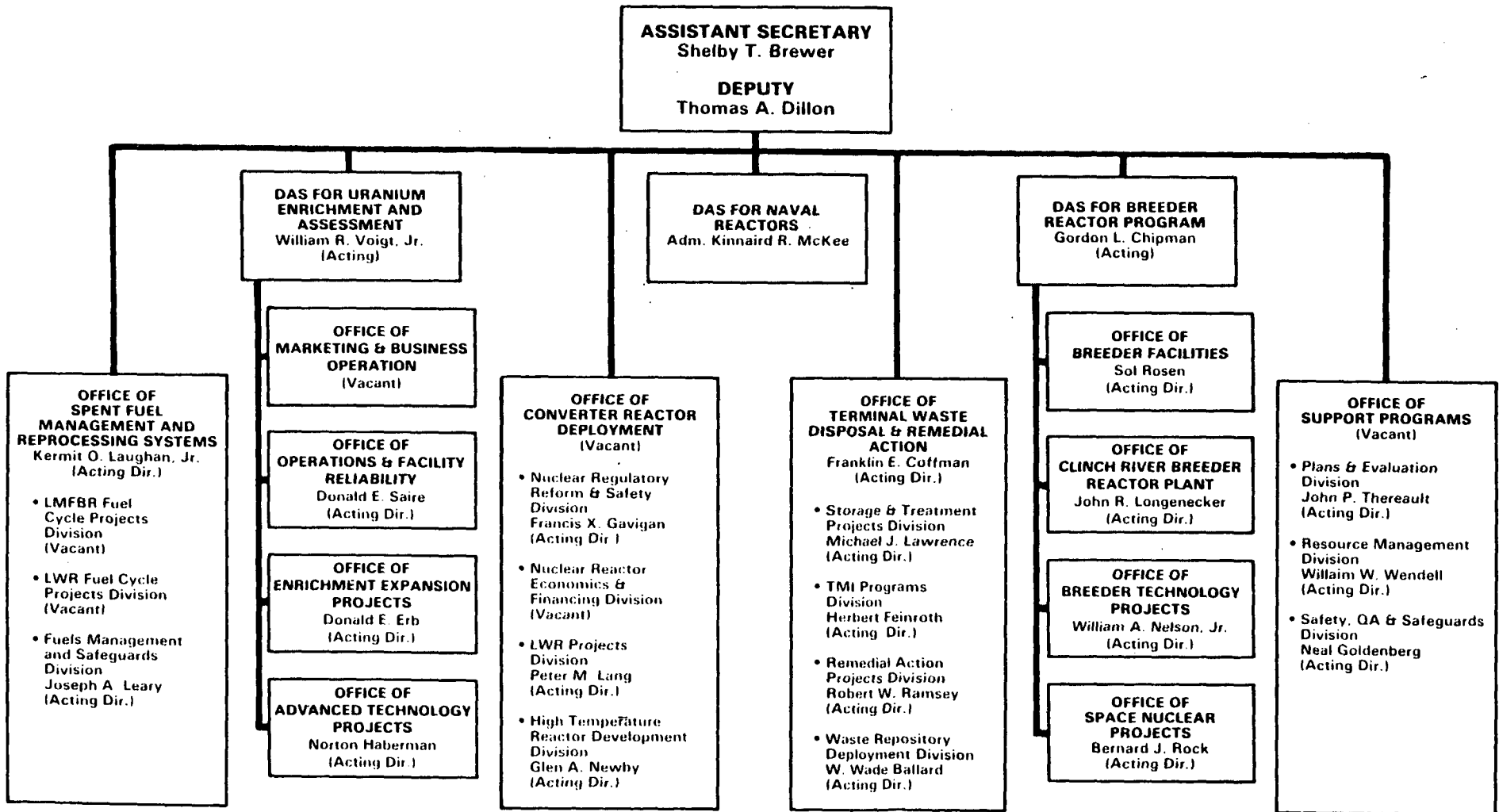

OFFICE OF NUCLEAR ENERGY

Office of Breeder Technology

Contact/Telephone No. -

D.K. Magnus/353-5004 for the Fuels and Core Materials Division

C. Purdy/353-4486 for the Materials and Structures Program

The applied research and development technology activities, conducted at several national laboratories, industrial organizations, universities and through bilateral and trilateral technology programs and exchanges with foreign nations, relate to current, advanced and alternate reactor systems. The scope of these activities include the following areas: fuel cycles; design and performance of high quality core components for fuels, blanket and control systems; development of the structural materials used in these components and systems; development and demonstration of equipment, processes and procedures for fabricating, processing, handling and producing plutonium bearing fuels, materials and components; sodium technology; standards and quality assurance; assuring a reliable high quality and affordable fuel supply for LMFBR's; destructive and non-destructive testing examination and evaluation of core components and the facilities and capabilities for conducting such examinations; responsibility for engineering and supporting facilities; associated safety, safeguards, and non-proliferation; maintaining competent capabilities in the several contractor organizations that conduct the pertinent R&D activities and programs. These activities are responsive to the administration's policies and goals and, to the DOE programs that support them.

In-reactor and out of reactor property evaluations are being conducted on core materials, clad/ducts, fuels and absorber materials. Through irradiation testing in FFTF and EBR-II, the Fuels and Core Materials Program is developing, qualifying and verifying the use of reference, improved and advanced mixed oxide fuels and boron carbide absorbers, including full size driver and blanket fuel, and absorber element pins and assemblies -- same for carbide fuels. Fabrication development, evaluation, qualification and verification (raw material processing, melting, hot working, cold working and finishing) are conducted on reference, improved and advanced alloys including in-reactor qualification of pins, ducts and assemblies; surveillance assemblies of reference materials now in FFTF Core 1. Improved and advanced materials are being tested for use in future cores.

The objectives of the materials and structures programs are to develop procedures that will assure economic and safe components and systems while providing designers with sufficient flexibility in components and systems design to facilitate optimization. Materials being evaluated are low alloy and stainless steels as well as ferrous superalloys. Major areas include materials characterization, radiation effects, mechanical properties, joining methods, non-destructive testing, tubology, corrosion and wear, and materials data documentation.

Appendices O and P provide more details.

High Temperature Reactor Development Division

Contact/Telephone No. - J. E. Fox/353-4162

The objective of the HTGR Program is to facilitate the commercialization of HTGR concepts by developing information and technology needed for important HTGR applications. Major areas are (1) development of metallic alloys with corrosion resistance and thermal stability for use in components such as heat exchangers, hot ducts, thermal barrier cover plates, control rods, seals and support structures, and (2) development of high strength nuclear graphite and other ceramic materials with adequate radiation and oxidation characteristics for use in fuel and reflector blocks, can support posts and blocks, and thermal barrier and structural support pads.

Light Water Reactor Systems Program

Contact/Telephone No. - Peter M. Lang/353-3313

The objective of the extended burnup subprogram of the LWR Systems Program is to develop technology to reduce the volume of spent fuel generated by LWR's in order to reduce the pressure on the back end of the fuel cycle. The major materials-related areas are (1) develop light water reactor fuel with improved pellet-cladding interaction performance allowing extended fuel burnup, (2) develop $Gd_2O_3-UO_2$ burnable absorbers for extended burnup, and (3) determine fission gas release from high burnup fuels. These development efforts include determination of properties of nuclear fuel materials and of behavior of these materials under severe conditions of temperature, pressure, and neutron irradiation.

Office of Naval Reactors

Contact/Telephone No. - Robert H. Steele/557-5561

The Materials Research and Development Program is in the Reactor Materials Division under the Deputy Assistant Secretary for Naval Reactors. The program supports the development and operation of improved and longer life reactors and pressurized water reactor plants for naval nuclear propulsion. In addition, during FY 1981 and 1982, this program supported the Light Water Breeder Reactor (LWBR) which operated in the Shippingport Atomic Power Station and the Advanced Water Breeder Activity to develop technical information that will assist U.S. industry in evaluating the LWBR for commercial scale applications.

The objective of the materials program is to develop and apply in operating service materials capable of use in the high power density and long life required of naval ship propulsion systems. This work includes irradiation testing of reactor fuel, poison, and cladding materials in the Advanced Test Reactor at the Idaho National Engineering Laboratory. This testing and associated examination and design analysis demonstrates the performance characteristics of existing materials as well as defining the operating limits for new materials.

Corrosion, mechanical property, and wear testing is also conducted on reactor plant structural materials under both primary reactor and secondary steam plant conditions to confirm the acceptability of these materials for the ship life. This testing is conducted primarily at two Government laboratories - Bettis Atomic Power Laboratory in Schenectady, New York.

One result of the work on reactor plant structural material is the issuance of specifications defining the processing and final product requirements for materials used in naval propulsion plants. These specifications also cover the areas of welding and nondestructive testing.

The materials program effort applied to the Water Breeder Reactor program included irradiation testing of the fuel rods utilizing the thorium-uranium-233 fuel cycle, which has the potential for providing appreciably more energy than the current design of water reactors. This testing provides the basis for the development of analytical models for use in calculating the performance of fuel rods in pressurized water reactors.

Funding for this materials program is incorporated in naval projects jointly funded by the Department of Defense and the Department of Energy and the Water Breeder Reactor program funded by the Department of Energy. This funding amounts to approximately \$55 million dollars in both FY 1981 and 1982, including slightly over \$20 million as the cost for irradiation testing in the Advanced Test Reactor.

Office of Space Nuclear Projects

Contact/Telephone No. - G. Bennett/353-3197

This office provides reactor and radioisotopic thermoelectric power sources for space flight and terrestrial missions. All applied research and development, fabrication, systems integration and safety requirements for power sources are responsibilities of this office.

Appendix Q provides more details.

Division of Waste Repository Deployment

Contact/Telephone No. - C. R. Cooley/353-4285

This program evaluates geologic and engineering materials for the isolation of radioactive wastes within deep-mined geologic formations, or within the subsea bed. This includes determination of properties of geologic and engineering materials (on exchange transport of radioactivity through geohydrologic systems, corrosion of metallic containers in geohydrologic environments, leaching), dissolution of radioactive glasses and ceramics, and expanding concretes and clays.

Appendix R provides more detail.

Appendix A: Office of Building Energy Research and Development

The Office of Building Energy Research and Development works to increase the energy efficiency of the buildings sectors through performance of R&D on building systems, building equipment, and community energy systems. In addition, the Office carries out the statutory requirements of appliance standards and labeling, building energy performance standards, the residential conservation service, and Federal energy management programs. Specific objectives include providing the technology to:

- o reduce energy consumption in existing buildings, and in new buildings;
- o increase the energy efficiency of oil and gas combustion heating systems and of oil- and gas-fired heat pump systems;
- o improve the energy efficiency of advanced electric heat pump and refrigeration systems, and of lighting systems; and
- o develop new planning techniques and systems that will decrease the energy consumption of communities.
- o funding is given below for FY 1981.

1. Considering Heat Exchanger Systems

\$ 80K

DOE Contact - Danny Lim (202) 252-9130
Battelle (Brookhaven Subcontract No. 490885)
Bud Woodworth (516) 345-2123

Investigation of materials feasible for use as heat exchangers for condensing oil- and gas-fired burners. Ceramics, stainless steel, plastics and lead-coatings are among the materials being considered.

Keywords: Corrosion, Materials Characterization, Ceramics

2. Thermal Insulation

\$162K

DOE Contact - William Gerken (202) 252-9191
ORNL (Contract No. 3470-0521)
D. L. McElroy (615) 574-5976

Evaluation of the thermal resistance of thermal insulation. Use of an instrumented Nichrome screen heater is being analyzed and a simple prototype constructed.

Keywords: Materials Characterization

3. Thermal Resistance of Insulation \$100K

DOE Contact - William Gerken (202) 252-9191
NBS - Gaithersburg (ORNL Subcontract No. 3740-5618)
F. Powell (202) 921-3637

Development of equipment to measure thermal resistance of insulating materials at thicknesses of up to six inches. Two prototypical line-heated guarded hot plates are being developed and compared to a heat flow meter technique.

Keywords: Materials Characterization

4. Corrosion in Insulating Materials \$ 59K

DOE Contact - William Gerken (202) 252-9191
Stevens Institute (ORNL Subcontract No. 3470-5763)
R. Weil (201) 420-4257

Corrosion testing studies with urea-formaldehyde foams and also with cellulosic insulation and fiberglass insulation.

Keywords: Corrosion

5. Insulating Materials \$ 43K

DOE Contact - William Gerken (202) 252-9191
Tennessee Technological U. (ORNL Subcontract No. 3470-5269)
Dave Yarbough (615) 574-5978

Operating temperatures of convectively-cooled, recessed incandescent light fixtures and of insulated fluorescent light fixtures are being measured. Effect of vibration on density of loose-fill insulation and effects of thickness change due to compressive loading on insulating batts and loose-fill insulation are also being measured.

Keywords: Materials Characterization

6. Convection Effects, Moisture Transport, and Condensation and Scattering \$ 39K

DOE Contact - William Gerken (202) 252-9191
U. of California - Berkeley (ORNL Subcontract No. 3470-5265)
C. Tein (415) 642-6000

Analytical and experimental studies on natural convection effects in insulation cavities, on moisture transport and condensation, and on the absorption and scattering characteristics of insulating materials.

Keywords: Materials Characterization

7. Out-gassing Substances

\$ 95K

DOE Contact - William Gerken (202) 252-9191
U. of Iowa (ORNL Subcontract No. 3470-5264)
K. Long (319) 353-2121

Identification of out-gassing substances from urea-formaldehyde foams. Attempting to demonstrate multiple-stage releases that depend on temperature and humidity.

Keywords: Materials Characterization

8. Permanency of Cellulosic Insulation

\$ 73K

DOE Contact - William Gerken (202) 252-9191
NBS - Gaithersburg (Contract No. DE-AI05-78OR06113)
S. Davis (202) 921-3744

Attempting to ensure that certain types of materials, which are suitable for flame-retarding cellulosic insulation, exhibit a degree of permanency. Materials being studied include: one part borax, 2 parts boric acid (25%); two parts borax, one part boric acid (25%); two parts borax, two parts boric acid, one part aluminum sulfate.

Keywords: Materials Characterization

9. Fire Performance of Insulation

\$ 12K

DOE Contact - William Gerken (202) 252-9191
Underwriters Lab
Wayne Kleinfelder (312) 272-8800

Conducting fire performance tests of insulation used as a cavity fill in residences. Radiant floor panel tests being conducted with different attic configurations. Primarily cellulosic insulating materials are being used.

Keywords: Materials Characterization

Appendix B: Office of Energy Systems Research

This office supports generic research of a long-term, high-risk, high-payoff nature aimed at stimulating innovation in conservation technology. The research is both broadly based and multi-sectoral, providing a technology base for the other conservation programs. The Office consists of three divisions: Energy Storage, Energy Conversion and Utilization Technologies (ECUT), and Electric Energy Systems. Funding is shown below for FY 1981.

Energy Storage Division

The principal function of the Energy Storage Division is to foster more efficient and more economical use of intermittent energy sources. A vital part of this R&D effort is the development, fabrication, characterization and compilation of data bases. Described below are the materials R&D efforts of the five subprograms of the Division.

1. Batteries and Electrochemistry

\$1,700K

DOE Contact - A. Landgrebe (202) 252-1474
ANL, Case-Western Reserve U., Ceramatec,
Dow Chemical, Diamond-Shamrock, Ford, Gould, MIT, U. of
Pennsylvania, Reynolds Metals, Stanford U., U. of Belgrade

Lithium-iron sulfide and sodium sulfur batteries operate at temperatures of several hundred degrees Celsius. Corrosion of container materials is a concern, as are materials for current collectors, separators, and seals. Of special importance is the development of processing techniques to make beta-alumina parts with reproducible properties for use in sodium sulfur batteries.

Aluminum alloys are being prepared and characterized for use as negative electrodes in aluminum-air batteries. Polymers are being synthesized and prepared as films for use as electrolytes and electrodes in storage batteries; glasses just for use as electrolytes. Catalysts which contain no platinum are being studied for use in the electrochemical reduction and oxidation of oxygen.

Keywords: Alloy Development, Alternate Materials, Coatings and Films,
Corrosion, Elastomers and Polymers, Joining Methods

2. Thermal Storage

\$2,300K

DOE Contact - R. Shivers (202) 252-1488
Rocket Research, Trans Energy, I.G.T., North Carolina U., Babcock
and Wilcox, Purdue U., Sandia Livermore, ORNL

Materials development activities include: development of domestic sources for ceramics for electric resistance charged heat storage units, including

improved physical (cracking and dusting) characteristics, improved heat transfer performances and reduced costs; development of building materials construction elements which incorporate phase change heat storage material for passive solar buildings; development of high-temperature storage materials and compatible containment materials for advanced industrial process heat storage application; research on the means of stabilizing the latent heat performance of salt hydrates which are useful for thermal storage; research to identify and characterize solid-solid transition phase change materials for thermal storage; and research on heat exchanger materials for fouling problem activities.

Keywords: Alloy Development, Alternate Materials, Transformations

3. Chemical and Hydrogen Storage \$ 900K

DOE Contact - M. Gurevich (202) 252-1488
Brookhaven, U. of Virginia, Teledyne Energy Systems, International Nickel, General Atomics, State U. of New York, Battelle - Columbus, ANL, JPL, Rocket Research, Life Systems, SRI, Ergenics, SoCal, General Electric, LASL, R. J. Teitel Associates

Work on the behavior of hydrogen includes: investigation of glass microspheres for hydrogen storage, H₂ embrittlement effects on pipeline steels; the use of metal hydrides for separation of hydrogen from natural gas and waste gas streams; SPE electrolytes for producing H₂ from water; electrodes and separators for alkaline electrolysis; process/materials for recovery of H₂ from H₂S; and catalysts for electrolytic and thermochemical hydrogen production. In other projects, chemical heat pumps are being developed for thermal energy upgrade and storage using sulfuric acid/water systems and selected pairs of metal hydrides.

Keywords: Alloy Development, Polymers, Catalysts

4. Mechanical Energy Storage \$1,000K

DOE Contact - R. Shrivvers (202) 252-1488
LLNL, MIT, Johns Hopkins U., RPI, Union Carbide, Rocketdyne, AVCO, Owens Corning, Ewald, Eton Co., ORNL

The primary emphasis is the development of Mechanical Energy Storage Technology (MEST) suitable for automotive and fixed-base application through in-house and contractual efforts. Of particular interest is the development of materials and the placing of them in appropriate configurations for flywheel rotors; development of elastomeric materials and configurations for braking energy recovery; and development of transmission systems and control techniques for flywheel-augmented power systems.

Keywords: Alloy Development, Alternate Materials, Elastomers and Polymers

5. Superconducting Magnetic Energy Storage

\$1,000K

DOE Contact - R. Shivers (202) 252-1488
LASL, U. of Wisconsin

The overall objective is to develop technology for both large-scale (1,000 MWh) diurnal energy storage plants and small-scale (10 kWh) utility system stabilization devices. The major emphases are the development of a low-cost polyester-glass support structure for cryogenic service and the development of a high-purity aluminum stabilizer conductor.

Keywords: Superconductors, Glasses, Alloy Development

Energy Conversion and Utilization Technologies Division

The purpose of the ECUT program is to support longer-term, generic and problem-solving research aimed at developing new technologies for increasing energy productivity. The program was initiated in FY 1981. It consists of seven projects, including a Materials Project. In its first year of operation, the ECUT Materials Project concentrated primarily on a series of research assessments that identified materials research opportunities with significant energy conservation potential. The budget for this work was \$350,000. In addition, the ECUT Physical Processes Project carried out research on development of innovative heat exchanger materials at a cost of \$82,000, bringing the total FY 1981 ECUT materials expenditure to \$432,000. These projects are described below.

1. Anti-Corrosive Coatings for Heat Transfer Surfaces

\$ 82K

DOE Contact - W. Thielbahr, Idaho Operations Office (208) 526-0682
Garrett Airesearch

Research is being carried out to determine the feasibility of applying, by chemical vapor deposition (CVD) aluminum anti-corrosive coatings to complex heat transfer surfaces in fully fabricated low-cost metallic heat exchangers.

Keywords: Corrosion

2. ECUT Materials Project

\$ 350K

DOE Contact - J. J. Eberhardt (202) 252-1500
ORNL, Rensselaer, Plastics Institute of America, MIT
ORNL Field Manager: J. Carpenter (615) 574-4571

Work in FY 1981 was principally devoted to identifying fertile research areas for work to begin in FY 1982. Short reviews, emphasizing identification of opportunities for enhancing energy efficiency through improvement of materials properties or production processes, were carried out in the

following areas: materials for high-temperature waste heat recovery; buildings insulation; materials for building heat exchangers; advanced electrodes for aluminum reduction cells; materials for the light-duty adiabatic diesel engine; materials for advanced heat engines; lightweight materials for ground transportation; tribological applications to ground transportation; recycle of plastics; and magnesium production. As a result of these studies, it was decided to initiate work in FY 1982 in three research areas: tribology; high-temperature materials; and polymers and plastics. Tribological research is concentrating on studies of the lubricating qualities of the constituents of base stock oils and the friction and wear of dissimilar ceramics at elevated temperatures. High-temperature materials efforts include studies on ordered metallic alloys, ceramic joining, toughening of ceramics, and alternative methods of producing SiC powders. Polymers and plastic work is concentrated on: recycle of plastic scrap from automobile shreds, polypropylene battery cases, and plastic beverage containers (began in late FY 1981); aging of rigid urethane foam insulation (also begun in late FY 1981); and study of plastic-coated low-temperature heat exchangers. Work on lightweight materials (lower-cost composites and innovative technologies for reducing costs in primary and secondary magnesium reduction and processing) is expected to begin in FY 1983.

Keywords: Alternate Materials, Ceramics, Elastomers and Polymers, Erosion and Wear, Adhesives and Lubricants, Joining Methods, Materials Characterization, Materials Processing

Electric Energy Systems Division

This program conducts R&D designed to expedite the development of higher-risk, long-term payback technologies which have a significant potential for improving the efficiency of the electrical energy system (e.g., increased capacity utilization, loss reduction). Research is also conducted in technologies for shifting fuel use from oil and gas to more abundant resources; on successfully integrating new energy sources (dispersed generation and storage) into the grid; and on investigating safety concerns.

1. Development of a Low-Resistance Magnetic Composite Material \$ 350K

DOE Contact - Jit Vora (202) 252-1633
General Electric (Contact No. AC01-78ETZ-9313)
Harley Lake (518) 385-8606

Develop and optimize the process necessary to produce a magnetic material made of amorphous metals. The resultant technology, when applied to magnetic circuits of electric power equipment, should lead to increased efficiency.

Keywords: Materials Processing

2. Development of Future Electrical Insulating Systems \$ 320K

DOE Contact - Jit Vora (202) 252-1633
National Bureau of Standards (Contract No. EX-77-A-01-6010/A053)
Richard Van Brunt (301) 921-3121

Develop advanced diagnostic techniques, test procedures and statistically valid models for monitoring and identifying aging or degradation processes in compressed gas electrical insulating systems under normal or near-normal operating conditions.

Keywords: Materials Characterization

3. High-Voltage Breakdown Strengths of Insulating Gas \$ 650K

DOE Contact - Russel Eaton (202) 252-4844
ORNL (Contract No. W-7405-ENG-0026)
Lucas Christophorou (615) 574-6199

Analyze, from a physiochemical point of view, the factors influencing the breakdown strength of gaseous dielectrics and seek gases with superior performance.

Keywords: Materials Characterization

4. Study of Gas Dielectrics as Cable Insulators \$ 100K

DOE Contact - Russell Eaton (202) 252-4884
MIT (Contract No. ET-76-C-01-2295-T019)
Chad Cooke (617) 253-2591

Fundamental study of gas dielectrics for insulation purposes which is covering four areas of applied research: basic gases and mixture studies, particle trap studies, large system performance, and insulating surface studies.

Keywords: Materials Characterization

5. Aging Process in Solid Dielectrics \$ 700K

DOE Contact - Russell Eaton (202) 2520-4844
Battelle - Columbus (Contract No. EC-77-C-01-5010)
Mike Epstein (614) 424-6424

Developing an understanding of insulating aging characteristics of solid dielectrics used for underground transmission cable systems. Develop and verify short-term cable test procedures which will accurately predict insulation life for its rated service.

Keywords: Materials Characterization

6. Synthetic Tape Development

\$ 600K

DOE Contact - Russell Eaton (202) 252-4844
Brookhaven (Contract No. ET-77-C-02-0016)
Bill Harrison (516) 345-2124, ext. 4774

Develop optimized polymeric film tapes for ambient temperature taped cable use.

Keywords: Elastomers and Polymers, Coatings and Films

7. Transient Breakdown Voltages in Solid Dielectric Cables

\$ 250K

DOE Contact - Russell Eaton (202) 252-4844
Cable Technology Lab (Contract No. ET-78-C-01-3062)
Carlos Catz (201) 846-3220

Develop a physical model of voltage aging for solid dielectrics used for high-voltage underground transmission cable systems. Develop a procedure for a short-term voltage test on solid dielectric cables.

Keywords: Erosion and Wear

8. AC Superconducting Power Transmission Cable Development

\$3,100K

DOE Contact - Russell Eaton (202) 252-4844
Brookhaven (Contract No. ET-76-C-02-0016)
E. Forsyth (516) 345-2123

Develop a flexible AC superconducting cable system based on NB_3Sn conductor and a tape dielectric. The project includes management of all supporting research on materials and refrigeration.

Keywords: Superconductors

Appendix C: Office of Vehicle and Engine R&D

The Office of Vehicle and Engine R&D has established a number of broad programs aimed at reducing highway vehicle fuel consumption. One, the Heat Engine Highway Vehicle Systems Program, is underway to develop advanced gas turbine, adiabatic diesel, and Stirling engines and to confirm their potential to achieve significant improvements in fuel consumption over the conventional spark-ignition engine. Project management responsibility for this program has been delegated to the NASA Lewis Research Center. Program management is the responsibility of the Office of Vehicle and Engine R&D. A related effort, the Heat Engine Highway Systems Materials and Components Technology Program, is being conducted for DOE by the Army Material and Mechanics Research Center (AMMRC).

The success of these advanced propulsion systems depends strongly on the development of new or improved materials. Ceramic materials are needed for the hot-flow-path components of the advanced gas turbine and the adiabatic diesel engines, to meet operating temperatures and manufacturing cost requirements. The Stirling engine requires low-cost iron-based alloys capable of operating at high temperatures while exposed to high-pressure hydrogen. Material technology development programs are underway for each of these propulsion systems. Key elements of each program are described briefly in the following. As indicated, most of the material development activities are being conducted by industry under contract. Further information can be obtained by contacting R. B. Schulz, Technology Development and Analysis Division, (202) 252-8064. Funding for FY 1981 and FY 1982 is indicated below by (81) and (82) respectively.

1. Ceramic Applications in Turbine Engines \$3,534K (81) \$1,370K (82)
 (CATE)

NASA Contact: P. T. Kerwin (216) 433-4000, extension 6770
Detroit Diesel Allison (NASA Subcontract DEN 3-17)
J. A. Byrd - (317) 242-5340

This program applies ceramic components to the Detroit Diesel Allison GT 404/505 gas turbine engines. Replacing existing metal parts allows increased operating temperatures, and thereby improves engine efficiency. Efforts include ceramic material characterization, ceramic process development, and ceramic design technologies.

Key Words: Ceramics and Glasses, turbine engines, silicon carbide, silicon nitride

2. Advanced Gas Turbine Powertrain \$1,860K (81) \$2,251K (82)
 Development (AGT-100)

NASA Contact: P. T. Kerwin (216) 433-4000, extension 6770
Detroit Diesel Allison/Pontiac (NASA Subcontract DEN 3-168)
H. E. Helms - (317) 242-5335

The AGT-100 project objective is to develop an advanced gas turbine engine capable of demonstrating, by September 1985, the DOE/NASA goals of improved fuel economy, reduced emissions, and alternative fuel capability. This will require the use of ceramic materials for most or all of the hot-section components. Efforts include material characterizations, process development, and component design and test.

Keywords: Ceramics and Glasses, turbine engines, silicon carbide, silicon nitride

3. Advanced Gas Turbine Powertrain Development (AGT-101) \$3,747K (81) \$3,820K (82)

NASA Contact: R. S. Palmer (216) 433-4000, extension 6653
Garrett/Ford (NASA Subcontract DEN 3-167)
E. E. Strain - (602) 267-2797

The AGT-101 project objective is to develop an advanced gas turbine engine capable of demonstrating, by September 1985, the DOE/NASA goals of improved fuel economy, reduced emissions, and alternative fuel capability. This will require the use of ceramic materials for most or all of the hot-section components. Efforts include material characterizations, process development, and component design and test.

Keywords: Ceramics and Glasses, turbine engines, silicon carbide, silicon nitride

4. Ceramic Durability Evaluation \$ 100K (81) \$ 120K (82)

NASA Contract: W. A. Sanders (216) 433-4000, extension 6153
Garrett Turbine Engine Company (NASA Subcontract DEN 3-27)
K. W. Benn - (602) 267-4373

The aim of this project is to assess the capability of materials to perform satisfactorily at the temperatures and exposure times required for automotive turbine engines. Commercially available ceramic materials (silicon carbide and silicon nitride) are being evaluated under extended thermal exposures of up to 2500°F for 3500 hours.

Keywords: Ceramics and Glasses, silicon carbide, silicon nitride

5. Ceramic Component Technology \$ 266K (81) \$ 381K (82)

NASA Contact: T. J. Miller (216) 433-4000, extension 6153

Development and evaluation of advanced techniques for fabricating and evaluating ceramic components are the targets of this project. Ceramic fabrication by hot isostatic pressing (HIP), and non-destructive evaluation (NDE) by techniques such as acoustic microscopy will be investigated.

Keywords: Ceramics and Glasses, HIP, NDE

6. Ceramic Stator Evaluation

\$0 (\$400K obligated in 80)

NASA Contact: G. K. Watson (216) 433-4000, extension 6905
Ford Motor Company (NASA Subcontract DEN 3-19)
E. A. Fisher - (313) 337-5485

The goals of this project are integral-stator fabrication development by four ceramic component suppliers, and property characterization of silicon nitride and silicon carbide. Durability testing of the stators in a simulated engine environment is being conducted to assess the overall potential of these ceramic materials.

Keywords: Ceramics and Glasses, turbine engines, silicon nitride, silicon carbide

7. High-Density Reaction-Bonded Silicon Nitride (RBSN)

\$0 (Effort Complete)

NASA Contact: S. Dutta (216) 433-4000, Extension 6111
Ford Motor Company (NASA Subcontract DEN 3-20)
E. A. Fisher - (313) 337-5485

Process parameters were developed to optimize silicon powder preparation and nitriding schedules to achieve high density RBSN ($> 2.8 \text{ g/cm}^3$) for injection-molded components. Improvements in strength and oxidation resistance were demonstrated.

Keywords: Ceramics and Glasses, silicon nitride, reaction sintering

8. Materials - Adiabatic Diesel

\$ 0 (81) \$ 880K (82)

NASA Contact: H. W. Davison (216) 433-4000, extension 8142

This is a new program. Planned effort includes development and evaluation of high-temperature low-thermal-conductivity materials for adiabatic diesel engines. A variety of materials are being considered, including zirconia, silicon nitride, silicon carbide, and various composites. The particular materials selected will depend upon factors such as component application, component design concept, material cost, and availability.

Keywords: Ceramics and Glasses, zirconia, silicon carbide, silicon nitride, adiabatic diesel engines

9. Material Characterizations - Stirling Simulation Rig Test

\$160K (81), \$140K (82)

NASA Contact: J. A. Misencik (216) 433-4000, extension 6676

Candidate Stirling engine alloys are being subjected to a simulated engine environment to assess the combined effects on material properties of high-pressure hydrogen, high temperature, and combustion products. Both commercial alloys and new experimental alloys will be evaluated, with emphasis on relatively low-cost iron-based alloys.

10. Material Characterizations - \$155K (81), \$70K (82)
High-Temperature Creep Evaluation

NASA Contact: R. H. Titran (216) 433-4000, extension 398

Creep properties of both commercial alloys and new experimental alloys will be characterized over a temperature range spanning the proposed operating temperatures of the Stirling engine. The effects of long-term (3500 hours) thermal aging at engine operating temperatures while exposed to hydrogen or argon at one atmosphere pressure will be assessed. Subsequent creep-rupture properties will be evaluated to determine mechanical property degradation due to aging, atmosphere, and time.

Keywords: Alloy Development and Alternative Materials,
creep rupture, hydrogen embrittlement, material
properties.

11. Material Characterizations - \$50K (81), \$30K (82)
Hydrogen Permeability of Alloys

NASA Contact: S. R. Schuon (216) 433-4000, extension 6826
ITT Research Institute (NASA Subcontract DEN 3-6)
S. Bhattacharyya - (312) 567-4192

Hydrogen permeability data are being obtained at Stirling engine operating temperatures and pressures for both commercial alloys and new experimental alloys, in high-purity hydrogen and in "doped" hydrogen.

Keywords: Alloy Development and Alternative Materials, hydrogen
permeability, material properties

12. Material Characterizations - Alloy \$181K (81), \$130K (82)
Properties in High-Pressure Hydrogen

NASA Contact: R. H. Titran (216) 433-4000, extension 398
ITT Research Institute (NASA Subcontract DEN 3-217)
S. Bhattacharyya - (312) 567-4192

Creep properties of candidate Stirling engine alloys will be measured in high-pressure hydrogen at engine operating temperatures using a specially designed creep test apparatus. The results obtained in hydrogen will be compared to results obtained in air to assess the effects of high-pressure hydrogen on material properties.

Keywords: Alloy Development and Alternative Materials,
creep rupture, hydrogen embrittlement, material
properties

13. Material Development - Improved Cast Cylinder Alloys \$0 (\$491K obligated FY 80)

NASA Contact: J. R. Stephens (216) 433-4000, extension 6826
AiResearch Casting Company (NASA Subcontract DEN 3-234)
M. Woulds - (213) 323-9500, extension 6905

The objective of this work is to develop and evaluate castable iron-based alloys for Stirling engine application which will meet performance requirements and reduce both cost and strategic material usage. Modifications to existing commercial or experimental castable alloys will be explored in order to develop materials which will allow heater head operating temperatures as high as 820°C.

Keywords: Alloy Development and Alternative Materials, iron-based alloys, material properties

14. Material Development - Cast Iron Alloy Containing Nonstrategic Elements \$151K (81), \$175K (82)

NASA Contact: Coulson Scheurmann (216) 433-4000, extension 267
United Technologies Research Center (NASA Subcontract DEN 3-282)
F. D. Lemkey - (203) 727-7318

The objective of this program is to identify a ferrous alloy, for the automotive Stirling engine cylinder and regenerator housings, which contains only nonstrategic materials. Alloy selection is based on the multi-component Fe-Cr-Mn(Mo)-Al-C(N) system which contains austenitic iron solid solution (8) matrices reinforced by finely dispersed carbide (carbo-nitride) phases.

Keywords: Alloy Development and Alternative Materials, iron-based alloys, material properties

15. Material Development - Evaluation of Improved Alloys \$49K (81), \$0K (82)

NASA Contact: S. R. Schuon (216) 433,4000, extension 6826

Mechanical properties and hydrogen permeabilities of improved heater tube alloys will be evaluated. The 19-9DL alloy, which is attractive except for permeability properties, is being modified by addition of strong oxide-forming elements such as aluminum. Tensile and creep properties of these modified alloys are being evaluated in-house, while hydrogen permeabilities will be measured under contract. A limited study is also being conducted on modification of low chromium (12 percent Cr) alloys.

Keywords: Alloy Development and Alternative Materials, iron-based alloys, hydrogen permeability, material properties

19. Stepped Stress-Rupture Studies

\$0K (81), \$45K (82)

AMMRC Contact: G. D. Quinn (617) 923-5258

The objective of this program is to perform quick preliminary screening tests on new ceramic materials. The following tests will be employed: (1) room-temperature strength, as measured by flexural modulus of rupture (2) room-temperature fracture toughness, as measured by Vickers indentation (3) stress rupture at 1200° (4) stepped-temperature stress-rupture (STSR) testing. In addition, characterization via chemical analysis, X-ray diffraction metallography and fractography will be used, and creep behavior will be studied via the STSR test. Materials to be tested include: Carborundum's latest sintered alpha silicon carbide, and the latest versions of AiResearch ceramics.

Keywords: Ceramics and Glasses

20. Advanced Transformation-Toughened Ceramics

\$0 (81), \$95K (82)

AMMRC Contact: R. N. Katz (617) 923-5754
University of Michigan
T. Y. Tien - (313) 764-9449

This effort is directed at the characterization of existing and the development of improved transformation-toughened ceramics for adiabatic engine applications. New (non-zirconia) systems offering enhanced strength, toughness, and lower cost potential will be explored, including alumina/chromia matrix, zirconia/hafnia, and precipitate composites. Work on the development of materials will take place via funding of an unsolicited proposal from the University of Michigan.

Keywords: Ceramics and Glasses, adiabatic engines, transformation-toughened ceramics

21. Toughened Ceramics for Advanced Heat Engines

\$0 (81), \$210K (82)

ORNL Contact: A. C. Schaffhauser (615) 624-4826

This program involves the development of ceramics with improved resistance to brittle fracture. The first phase of this work includes exploratory development at Oak Ridge National Laboratory (ORNL) on dispersion-toughened SiC and Al₂O₃ using ductile metal or intermetallic particles, and processing development on Si₃N₄ fiber composites by a qualified subcontractor. Characterization of the structure and toughness of these materials is also included. The second phase will include optimization of processing parameters, dispersion and/or fiber and matrix characteristics, and evaluation of the high-temperature properties after long-term exposure.

Appendix D: Office of Industrial Programs

This office conducts cost-shared R&D on selected energy conservation technologies. The primary foci are processes with wide-ranging industrial applications and processes which are specific to the most energy-intensive industries. Research attempts to develop the technology needed for improving the energy productivity of industrial processes for reducing the amount of waste energy. Funding given below is for FY 1981.

1. Low-Energy Lime and Cement

\$75K

DOE Contact - Jerome Collins (202) 252-2366
Southwest Research Institute (Contract No. DE-AC03-79C40250)
William Mallow (512) 684-5111, extension 2341

The aim of this project is to develop a low-energy method for the conversion of limestone to lime for use in the manufacture of hydraulic cements. Laboratory process development and feasibility studies are focused on the catalytic decarboxylation of fine-ground limestone to produce a slaked lime slurry. Approximately 3.5 million barrels of oil equivalent are expected to be saved annually if this process is proven effective and reaches its commercial potential.

Keywords: Cements and Concrete, Catalysts, Lime

2. High-Temperature Heat Pump

\$700K

DOE Contact - John Eustis (202) 252-2084
Westinghouse Electric (Contract No. EC-77-01-5026)

The objective of this project is to develop and demonstrate a reverse Rankine cycle heat pump system that could provide steam at higher delivery temperatures (-320°F) than commercially available heat pumps (-210°F). The project consists of the full-scale design and development of a system to be constructed at a Westinghouse facility in Pennsylvania.

Keywords: Materials Characterization, Alternate Materials

3. Fluid Degradation

\$49.8K

DOE Contact - John Eustis (202) 252-2084
Sundstrand
R. Gaudet (815) 226-6000

Establishing the volume and location of noncondensable gases and other undesirable compounds in an Organic Rankine Cycle system. Determining the rate of build-up of benzoic acid and iron benzoate. Project is to be completed in FY 1982.

Keywords: Corrosion, Materials Characterization

4. Ceramics for a High-Temperature Heat Exchanger

\$550K

DOE Contact - James Osborne (202) 252-2084

ORNL

Anthony Schaffhauser (615) 574-4826

Characterizing silicon carbide ceramics for use in high-temperature industrial recuperators. Also, testing effects of fuel impurity on ceramics and metals. In tandem with this effort, high-temperature recuperators will be demonstrated in industrial settings (e.g., aluminum remelting furnace, glass melting furnace).

Keywords: Ceramics, Corrosion, Materials Characterization

Appendix E: Office of Solar Electric Technologies

The overall goal of this office is to accelerate the development and wide-spread use of solar energy in the production of electricity through performance of R&D on high-risk, high-payoff technologies. The Office contains three divisions: Photovoltaic Energy Technology, Wind Energy Technology, and Ocean Energy Technology.

Photovoltaic Energy Technology Division

This program supports R&D activities whose aim is both to advance the scientific understanding and to establish the technology base needed in order for the private sector to develop and utilize advanced photovoltaic energy systems.

Materials R&D work in the photovoltaics program investigates concepts, materials and structures which will lead to low-cost solar cells, and it seeks both collector and balance-of-system development. Due to space limitations, general categories of research, rather than individual projects, are presented below. Further detail on the material R&D of the Program can be found in the Photovoltaic Energy Systems Program Summary (January, 1982, DOE/CS Dist. Category UC-63).

1. Polycrystalline Thin Film Materials \$2,200K (81), \$2,400K (82)

DOE Contact - Alan Postlethwaite (202) 252-1723 (FTS 252-1723)
Solar Energy Research Institute
Allen Herman (303) 231-1311 (FTS 327-1311)

This project has discovered certain degradation modes present in copper sulphide thin films and will now place primary emphasis on the more stable copper indium diselenide material. Other photovoltaic materials to be explored are: zinc phosphide, cadmium telluride, zinc silicon arsenide, indium phosphide, copper selenide and tungsten diselenide. The goal of this effort is to demonstrate the technical feasibility of at least two polycrystalline thin film materials by the mid 1980's.

Keywords: Coatings and Films, Solar Cells

2. Polycrystalline Silicon Cells \$20K (81), \$16K (82)

DOE Contact - Alan Postlethwaite (202) 252-1723 (FTS 252-1723)
Solar Energy Research Institute
Jack Stone (303) 231-1370 (FTS 327-1730)

This project seeks to obtain large-grain films with photovoltaic array efficiencies greater than 10%; the fabrication of these devices on low-cost substrates is emphasized. Exploratory development activities have been initiated, with a goal of demonstrating technical feasibility in FY 1983.

Keywords: Coatings and Films, Solar Cells

3. Amorphous Thin-Film Materials

\$2,800K (81), \$3,200K (82)

DOE Contract - Alan Postlethwaite (202) 252-1723 (FTS 252-1723)
Solar Energy Research Institute
Jack Stone (303) 231-1370 (FTS 327-1370)

Advanced hydrogenated amorphous silicon is being studied to obtain an understanding of the fundamentals of the defect-state passivation process which has led to efficiencies greater than 6.5% for solar cells with areas over 1cm². Amorphous materials other than amorphous silicon:hydrogen, such as amorphous silicon carbide, amorphous boron, and amorphous silicon:hydrogen: fluorine, are also being investigated.

Keywords: Coatings and Films, Solar Cells

4. Advanced Concentrator Concepts

\$1,150K (81), \$1,250K (82)

DOE Contract - Alan Postlethwaite (202) 252-1723 (FTS 252-1723)
Solar Energy Research Institute
John Benner (303) 231-1396 (FTS 327-1396)

Study of concepts, such as multi-junction concentrator cells, which offer projected efficiencies approaching 30%, and luminescent converter concentrators.

Keywords: Materials Processing, Solar Cells

5. Electrochemical Photovoltaic Cell

\$1,150K (81), \$1,250K (82)

DOE Contract - Alan Postlethwaite (202) 252-1723 (FTS 252-1723)
Solar Energy Research Institute
William Wallace (303) 231-1380 (FTS 327-1380)

Centers on fundamental studies of the semiconductor/electrolyte interface and its uses for low-cost, stable, high conversion efficiency devices for in-situ storage. The near-term goals of this effort are to develop a stable cell conversion efficiency of 10% in FY 1984 using amorphous or poly-crystalline electrodes.

Keywords: Materials Processing, Solar Cells

6. Low-Cost Solar Array

\$12,000K (81), \$11,000K (82)

DOE Contract - Alan Postlethwaite (202) 252-1723 (FTS 252-1723)
Jet Propulsion Lab
Kris Kollivad (213) 577-5197 (FTS 792-5197)

Flat-plate silicon arrays are being developed. The project addresses all steps in the array production process, including purification of raw polysilicon, growth of silicon sheets, creation of an individual solar cell, encapsulation and high-volume automatic array assembly. Emphasis is placed in improving quality while reducing cost during each phase.

Keywords: Materials Processing, Solar Cells

Wind Energy Technology Division

The R&D work of the wind program emphasizes the attainment of reductions in the cost of energy from WECS (wind energy conversion systems) through testing of blades and other advanced components, as well as the basic study of systems, components, and materials for wind machines.

1. Fiberglass/Resin Composite \$28K (81), \$0 (82)
Material Fatigue

DOE Contact - Peter Goldman (202) 252-1776 (FTS 252-1776)
IIT Research Institute (Contract No. DEN 3182)
NASA Project Manager: R. Lark (216) 433-5103 (FTS 252-5103)

The objective of this research was to characterize and compare the static and ultra-high cyclic fatigue properties of fiberglass/polyester resin composite laminates and fiberglass/epoxy resin composite laminates. Fiberglass/polyester resin composites offer the potential for improving wind turbine rotor blade fabrication processes when compared to processes using fiberglass/epoxy materials. Laminates of fiberglass/epoxy and fiberglass/epoxy and fiberglass/polyester resin were fabricated and subjected to static and ultra-high (approaching 4×10^8) cyclic fatigue tests. As a result, a data base characterizing design allowable stress levels as a function of the number of anticipated bending cycles for these materials was developed. The final report of this research project is complete and should be published in June 1982.

Keywords: Materials Characterization

2. Corrosion Resistant Steel Spot Welded Joint
Fatigue Life Characterization for Wind \$20K (81), \$16K (82)
Turbine Rotor Blades

DOE Contact - Peter Goldman (202) 252-1776 (FTS 252-1776)
Budd Company
NASA Project Manager - R. Lark (216) 433-5103 (FTS 294-5103)

The objective of this research is to characterize the static and ultra-high (4×10^8) cyclic fatigue properties of stainless steel type 301 spot welded sheet joints. Corrosion resistant materials offer the potential for long life, and low maintenance wind turbine rotor blade performance, in salt air environments. A variety of spot welded joints were fabricated utilizing laminated spot welded construction. A report on this research will be published in FY 1982. Fatigue testing of the blade spar was initiated in May 1982 and will be completed in FY 1982.

Keywords: Materials Characterization

3. Wood Composite Material Fatigue

\$0 (81), \$75K (82)

DOE Contact - Peter Goldman (202) 252-1776 (FTS 252-1776)
University of Dayton Research Institute (Contract No. DEN 3-286)
NASA Project Manager - R. Lark (216) 433-5103 (FTS 294-5103)

The objective of this research is to characterize the static and fatigue properties of laminated wood composite materials with applications to more efficient structure design of rotor blades. Laminated wood composite test specimens have been fabricated and will be subjected to ultra-high (approaching 4×10^8) cyclic fatigue loads. Completion of tests is planned in early FY 1983 and test results will be reported in late FY 1983.

Keywords: Materials Characterization

Appendix F: Office of Renewable Technology

The Office of Renewable Technology consists of three divisions: the Geothermal and Hydropower Division, the Energy From Municipal Waste Division, and the Biomass Energy Technology Division. In FY 1981, only the first two divisions conducted materials R&D programs; accordingly the Biomass Energy Technology Division is not discussed below. Funding is given for FY 1981.

Geothermal and Hydropower Division

This division support high-risk, high-payoff R&D aimed at developing the basic technology needed for the private sector to more fully utilize geothermal energy resources for both electric power generation and direct heat applications. Materials R&D is being conducted within six subprograms: Geothermal Materials, Geochemical Engineering, Hot Dry Rock, Drilling and Completion, Geothermal Logging Instrumentation, and the Raft River 5 MWe Binary Plant.

(A) Geothermal Matrials

The Geothermal Materials Program is coordinated by the Brookhaven National Laboratory; Brookhaven Contact Larry Kukacka (516) 282-2123.
DOE Contact - Leon Lehr (202) 252-8076

1. Development of Geothermal Well Completion Systems \$7K

Dowell Division of Dow Chemical (Contract No. DE-AC02-77ET283324)
E. Nelson (918) 250-4271

Develop and evaluate a suitable geothermal well cementing material through stability, placement, and chemical measurements.

Keywords: Cements and Concrete, Eleastomers and Polymers

2. Alternate Materials of Construction \$300K

Brookhaven (Contract No. DE-AC02-76CH00016)
L. Kukacka (516) 282-2123

Evaluating and developing alternate materials of construction. The work includes determination of engineering design requirements, testing of prototype equipment, economic evaluations, and plant demonstrations. Program makes use of subcontracts and industrial participation.

Keywords: Alternate Materials, Elastomers and Polymers

3. Cementing of Geothermal Wells \$50K

Brookhaven (Contract No. DE-AC02-76CH00016)
L. Kukacka (516) 282-2123

Developing improved cements which are specifically designed for geothermal well applications. The task includes preparation of a technical plan, testing and practical demonstration of new cements, and transfer of the technology to the private sector.

Keywords: Cements and Concrete, Materials Characterization

4. Pitting-Resistant Alloys \$250K

Brookhaven (Contract No. DE-AC02-76H00016)
D. Van Rooyen (516) 282-4050

Developing metallic alloys and steels that possess improved properties and are cost-effective. The project makes use of subcontracts with industry, laboratories, and universities.

Keywords: Alloy Development

5. Materials Needs for the Utilization of Geothermal Energy \$50K

National Academy of Sciences, National Material Advisory Board (Brookhaven Subcontract No. 494818)
D. Groves (202) 389-6526

Identified materials problems that limit the design and operation of cost-effective geothermal energy systems, and recommended appropriate actions. The final report was issued in March, 1981.

Keywords: Materials Characterization

6. Economic Impact of Using Non-Metallic Materials \$55K

National Water Well Association (Brookhaven Subcontract No. 485874)
T. Gass (614) 846-9355

Evaluating the potential economic impact of the use of plastic materials in low-temperature (150°C) geothermal well construction. Data from the project are currently being compiled.

Keywords: Elastomers and Polymers

7. Elastomer Materials Technology Transfer \$100K

L'Grade, Inc. (Brookhaven Subcontract No. 490316)
A. Hirasuna (714) 645-4880

Transferring to industry the elastomer technology developed under an earlier contact, and continuing the developing of high-temperature sealing materials.

Keywords: Elastomers and Polymers, Seals and Bearings

8. New Fluorocarbon Elastomers for Seals \$155K

Exfluor Research (Brookhaven Subcontract No. 486106)
E. Dumitru (512) 454-3812, or (512) 471-5679

Attempting to increase the operating capabilities of elastomers in geothermal environment to 300°C by cross-linking and subsequent fluorination of elastomeric materials.

Keywords: Elastomers and Polymers, Seals and Bearings

9. Design and Fabrication of Polymer Concrete Pipe \$20K

Lindsey Industries (Brookhaven Subcontract No. 486337)
J. Schroeder (213) 969-3471

Designing and fabricating a full-scale section of polymer concrete pipe and investigating appropriate joining methods for direct utilization of geothermal processes.

Keywords: Cements and Concrete

10. Improved Drill Bit Material \$70K

Terra Tek (Brookhaven Subcontract No. 492267)
R. Hendrikson (801) 582-2220

Attempting to ensure longer life of drill bits and reamers through optimization of alloys and heat treatment of candidate alloys. Liaison is being maintained with interested bit manufacturers.

Keywords: Alloy Development, Materials Characterization

11. Pump Bearing Materials Development \$50K

Solar Turbines International (Brookhaven Subcontract No. 490656)
D. Huey (714) 238-5609

Developing durable materials that will resist wear and deterioration when used as bearings in pumps. The goal is to improve pump lifetimes and to increase the efficiency of heat extraction from geothermal wells.

Keywords: Seals and Bearings, Erosion and Wear

12. Well Casing Materials \$80K

Lawrence Livermore National Lab (Contract No. W-7405-Eng-480)
R. D. McCright, W. P. Frey, R. Kuan (415) 422-7051

Evaluating the corrosion performance of carbon and alloy steel (up to 9 Cr-1 Mo) tubing string materials exposed for six months in a producing well at the Salton Sea geothermal field. Some API steels were heat treated. All materials were exposed to brine in the well at three different depths.

Keywords: Alloy Development, Alternate Materials, Corrosion, Materials Processing

13. Shape Memory Alloy Seals \$100K

Rockwell International (Brookhaven Subcontract No. 509927)
W. Firske (213) 341-1000

Developing durable high-temperature metallic seals for downhole pump applications. The sealing technique utilizes the unique properties of nickel-titanium (Nitinol) "memory alloy" to provide the seals.

Keywords: Alloy Development, Seals and Bearings

14. Hydrogen Embrittlement and Localized Corrosion of Steels \$115K

Case Western Reserve U. (Brookhaven Subcontract No. 510034)
A. Troiano (216) 368-4234

Using the NACE tensile test to evaluate in a sour environment a series of new alloys now being developed and prepared for service in geothermal downhole applications.

Keywords: Alloy Development, Corrosion

15. Cathodic Protection of Well Casings

\$2K

San Diego State U.

Brookhaven Contact: Larry Kukacka (516) 282-2123

This project, started in FY 1981, is determining the feasibility of use of cathodic protection for high-temperature applications of well casings and above-ground components. The first phase is to be completed in FY 1982.

Keywords: Corrosion

16. Geothermal Materials Compatibility and Failure Analysis

\$17K

Radian Corporation

P. Ellis (512) 454-4797

Providing corrosion engineering support services and component failure analysis. Also, preparing geothermal well materials reference book.

Keywords: Corrosion

(B) Geochemical Engineering

The Geochemical Engineering Program is coordinated by the Battelle Pacific Northwest Laboratory; PNL Contact - Donald Shannon (509) 376-3139. DOE Contact: Leon Lehr (202) 252-8076.

1. Sampling and Analysis of Geothermal Fluids

\$100K

Pacific Northwest Lab

C. H. Kindle (509) 376-5904

Developing standardized, accurate fluid and gas sampling/analysis methods through industry/government/university cooperative efforts. Standardization and acceptance is being accomplished through the American Society for Testing and Materials. Isobutane sampling is being emphasized.

Keywords: Corrosion

2. High-Temperature Chemical Sensors for Geothermal Fluids

\$630K

Leeds and Northrup, U. of Pennsylvania, Owens Illinois, General Electric, Pacific Northwest Lab
George Jenson (509) 376-9124

Developing electrical and electrochemical probes that can measure the chemical environment of geothermal water and steam under the high-pressure, high-temperature conditions of a geothermal well and associated piping. Such data will permit the prediction and control of corrosion, scaling, and pollution in geothermal systems. Subprojects are: high-temperature glass pH electrode development, geothermal CO₂ sensor, chemically sensitive semiconductor devices, zirconia-based pH-electrode development, redox electrode development, and improved corrosion ratemeter.

Keywords: Corrosion, Semiconductors

3. Binary Cycles Fluid Case Study

\$155K

Pacific Northwest Lab
Donald Shannon (509) 376-3139

Developing and demonstrating to industry advanced methods for monitoring geothermal power plants. Methods are being tested in the Magma Electric Company's 10MWe cycle plant. Technical assistance is also being provided for materials and chemical monitoring of the Heber Geothermal Binary 15 MWe Demonstration Plant. In addition, corrosion samples and NDE of heat exchanger are included in this effort. Total funding for this study (including non-materials research) is \$460K.

Keywords: Corrosion, NDE

(C) Hot Dry Rock

The Hot Dry Rock (HDR) Energy Extraction Demonstration Program is coordinated by Los Alamos National Lab; LANL Contact - John Rowley (505) 667-1378.
DOE Contact: A. Jelacic (202) 252-8020.

The objective of this effort is to determine the technical and economic feasibility of hot dry rock concepts. A major element of the program is the Phase II Energy Extraction System at the Fenton Hill Test Site, which consists of two well bores drilled to a maximum depth of 15,000 feet and connected by a series of hydraulic-induced fracture.

1. Cablehead

\$10K

LASL In-House Project
Bert Dennis (505) 667-5697

Developing cablehead for borehole logging and fracture mapping for the Phase II System at the Fenton Hill site. Bottom-hole temperature in the EE-2 well-bore is 317°C. Cablehead is designed for field assembly and for durability in the geothermal environment. It has been deployed in the borehead for temperature and caliper logs with no failures to date.

Keywords: Elastomers and Polymers, Adhesives and Lubricants

2. High-Temperature Armor Cable

\$50K

Southwest Research Institute (LASL Subcontract No. 4-L40-4069M-1)
Roy S. Marlow (512) 684-5111

Testing samples of high-temperature well logging around instrument cable for use in geothermal boreholds. Also testing electrical integrity of insulation materials and cable performance at 275°C and 8,000 psi fluid pressure. Electrical insulation materials primarily being used are PFA and TFE teflon.

Keywords: Elastomers and Polymers, Materials Characterization

1. Metal-Sheathed Logging Cable Development \$175K
Halpen Engineering (Scandia Contract No. 13-5163)
A. Halpenny (716) 855-0116

Commercial development of a metal-sheathed, mineral-insulated, single-conductor, electrochemical logging cable for continuous operation in geothermal wells at temperatures of up to 350°C.

Keywords: Materials Processing, Logging Cables

2. Diamond Compact Wear Mechanisms \$100K
General Electric (Sandia Contract No. 13-9406)
L. E. Hibbs, Jr. (518) 385-8330

The objective of this project is to provide technical support in regard to the effects of drilling fluids on the required cutting force, wear mechanisms, and wear rates of polycrystalline diamond compacts.

Keywords: Erosion and Wear, Ceramics, Materials Characterization

3. Geothermal Drill Bit Seals and Lubricant Development \$120K
Terra Tek (Sandia Contract No. 46-3053)
J. Finger (505) 844-8089

This project seeks to develop a 200-hour life bearing and seal package adaptable to most types of downhole motors that operate at a 121°C (250°F) circulation temperature.

Keywords: Seals and Bearings, Adhesives and Lubricants

4. Chemical and Elevated Temperature Effects on Clay-Based Drilling Fluids \$100K
Texas Tech U.
M. Guven (806) 742-3110

This project seeks to develop a fundamental understanding of clay particle morphology under the influence of both various chemical species and elevated temperatures similar to the conditions encountered during geothermal drilling activities.

Keywords: Adhesives and Lubricants

5. High Temperature Elastomers \$100K

Sandia Project
C. Arnold (505) 844-8728

Investigating Elastomeric materials and material design considerations for high-temperature elastomers. Such elastomers are needed in both geothermal drilling system bearings and seals and in downhole tools used in geothermal drilling and completions and borehold logging.

Keywords: Elastomers and Polymers

6. Investigation of Inert Geothermal Drilling Fluids/Gases \$300K

Sandia Project
B. C. Caskey (505) 844-8835

Experimentally evaluating the field performance of alternate drilling fluids and gases, such as nitrogen. The aim is to inhibit the chemical corrosion of geothermal drill pipe while minimizing erosion and wear on the drilling components.

Keywords: Corrosion, Erosion and Wear

7. Drillstem Corrosion Testing \$150K

Sandia Project
R. J. Salzbrenner (505) 844-5041

Investigating the effects of corrosion fatigue and stress corrosion cracking on candidate geothermal drillstem materials.

Keywords: Corrosion, Erosion and Wear, Materials Characterization

8. High-Temperature Particulate Plugging Agents \$300K

Sandia Project
J. Kelsey (505) 844-6968

Developing materials to help improve circulation in geothermal wells. Research centered on high-temperature particulate agents for plugging large fractures.

Keywords: Materials Characterization

9. Carbide Development \$80K

SRI, International
Sandia Contact: J. Finger (505) 84408089

Developing non-stoichiometric carbides to increase both the toughness and hardness of materials used where abrasions can occur. Investigation is focused on the study of tantalum carbides and niobium carbides.

Keywords: Ceramics

10. Aqueous Foams

Sandia Project
Chuck Carson (505) 844-6477

Developing aqueous foam for use as a geothermal drilling fluid. Evaluating properties at high temperatures in the presence of geothermal brines.

Keywords: Materials Characterizations

(E) Geothermal Logging Instrumentation

The Geothermal Logging Instrumentation Materials Support Program is coordinated by the Sandia National Lab; Sandia Contact James Kelsey (505) 844-6968.

DOE Contact: Ray La Sala (202) 252-8077

1. High-Temperature Thick Film Development

\$ 60K

Purdue U. (Sandia Subcontract No. 42-5815)
R. W. West (317) 749-6244

Developing a family of ceramic thick film materials (conductive, resistive, dielectric, and semiconductive) which retain useful electrical and mechanical characteristics for both extended periods (10^5 hours) at 300°C and short periods (1,000 hours) at 500°C .

Keywords: Coatings and Films, Ceramics, Semiconductors, Glasses

2. Gallium Phosphide Semiconductor Fabrication

\$200K

Sandi Project
T. Zipperian (595) 844-6407

Developing a materials processing technique and electric contacts for gallium phosphide semiconductors that must operate at 275°C for at least 1,000 hours.

Keywords: Materials Processing, Coatings and Films, Semiconductors

3. High-Temperature Gallium Phosphide and Gallium Arsenide Semiconductors \$50K

Texas A&M U. (Sandia Subcontract No. 42-7271)
O. Eknayan (713) 845-7030

Investigating metallization, passivation and doping techniques to establish a technological basis for the fabrication of high-temperature (GaP, GaAs) diodes, controlled rectifiers, and the eventual design of transistors.

Keywords: Coatings and Films, Materials Processing, Semiconductors

4. High Temperature Magnetic Materials Reserach

\$ 30K

Texas A&M U. (Sandia Subcontract No. 42-5820)
R. K. Pandey (713) 845-7030

Measuring magnetic properties of commercially available soft and hard materials at temperatures ranging from 20^oV yo 400^oC.

5. Amorphous Metallization for Semiconductor Circuits

\$ 40K

U. of Wisconsin (Sandia Subcontract No. 49-1664)
J. D. Wiley (608) 262-3736

Investigating the related phenomena of diffusion and electromigration in amorphous metals. Obtaining experimental data needed to assess feasibility of using amorphous metal films for metallization on high-temperature semiconductor integrated circuits in order to improve reliability.

Keywords: Coatings and Films, Semiconductors, Materials Characterization

(F) Raft River 5 W Binary Plant

\$100K

DOE Contact - Denis Feck (202) 252-5778
EG&G, Idaho
Judd Whitbeck (208) 526-1879

Providing corrosion and scale inhibitor support for the Raft River Project.

Keywords: Corrosion

Energy from Municipal Waste Division

This division conducts long-range, generic research on processes and systems that use municipal wastes. Its aim is to develop the technological base for enhancing energy recovery, particularly in key municipal applications, such as water and wastewater treatment facilities.

1. Material Corrosion in Municipal Waste-to-Energy Incinerator Systems \$100K

DOE Contact - Donald Walter (202) 252-6104
NBS - Chemical Thermodynamics Division (Contract No. 20528)
Joseph Berke (301) 921-2343

Examining corrosion problems at several municipal waste burning sites. The aim is to determine the possibility of developing a short-term test for the corrosive property of candidate materials in the harsh environment of municipal waste energy recovery systems.

Keywords: Erosion and Wear

Appendix G: Office of Solar Heat Technologies

The Office of Solar Heat Technologies conducts R&D aimed at providing a technological base from which low-cost, reliable solar energy source systems can be generated. The Office contains three divisions: Active Heating and Cooling, Passive and Hybrid Solar Energy, and Solar Thermal Technology. Funding is given for FY 1981.

Active Heating and Cooling Division

This program funds F&D projects with industry and academic institutions directed towards the development of cost-effective, reliable and publicly acceptable active solar heating and cooling systems. A major emphasis of the program is to ensure that the information derived from these projects is made available to all of the members of the solar community who will benefit from it.

1. Development of Selective Surfaces

\$ 25K

DOE Contact - Carl Conner (202) 252-8156
The Berry Group (DOE Contract No. DE-AS04-78CS34293)
John Cotsworth (291) 549-3800

Developing improved techniques for producing selective surfaces on stainless steel, aluminum, and copper. Testing several of these surfaces under conditions of ultraviolet radiation, heat and humidity and investigating the feasibility of large-scale production of the selective surfaces.

Keywords: Coatings and Films, Materials Processing, Materials Characterization, Radiation Effects

2. Selective Paint Scale-Up Development

\$127K

DOE Contact - Carl Conner (202) 252-8156
Honeywell, Avionics Division (DOE Contract No. DE-AC04-78CS14287)
Paul Zimmer (615) 378-5718

Investigating various manufacturing techniques for the large-scale production of a low-cost, durable, thickness-sensitive selective paint coating for flat-plate solar collector panels. Also, optimizing the optical properties of the thickness-insensitive selective paint coating.

Keywords: Coatings and Films, Materials Processing, Materials Characterization

3. Evaluation of Selective Solar Absorber Surfaces

\$ 40K

DOE Contact - Carl Conner (202) 252-8156
Lockheed - Palo Alto Research Lab (DOE Contract No. DE-ACo4-78CS15361)
Stanley Greenberg (415) 493-4411

Phase I consisted of the sampling and limited environmental exposure of a large number of selective absorber surface finishes. In Phase II, degraded (environmentally exposed) and non-degraded finishes are being analyzed in an effort to determine the degradation mechanisms operative in the coating.

Keywords: Coatings and Films, Erosion and Wear

4. Corrosion Resistance of Metallic Solar Absorber Materials

\$100K

DOE Contact - Carl Conner (202) 252-8156
Olin-Metals (DOE Contract No. DE-ACo4-81?AL16222)
Edward Smith (203) 789-5293

Generating long-term corrosion data applicable specifically to solar collectors. Testing commercially-available heat transfer liquids with a variety of alloys currently used in solar absorbers. Establishing the susceptibility of these metals to various forms of corrosive attack in each of the liquids. Establishing a correlation between laboratory corrosion data and the corrosive attack found in actual solar collectors.

Keywords: Corrosion

5. Reliability and Maintainability Program

\$740K

DOE Contact - Carl Conner (202) 252-8156
SERI (Contract No. EG-77-C-01-4042)
Tom Hafferty (3030 231-1000)

Providing the latest information from R&D to groups with reliability and maintainability (R&M) concerns. Assisting in the design, manufacture, installation, and maintenance of reliable and durable systems. As part of this work, developing a laboratory method for analyzing R&M data, performing fluid corrosion and atmospheric corrosion research, determining the characteristics of typical solar collector parameters during system failure, and developing a corrosion sensor for collector systems.

Keywords: Corrosion, Materials Characterization

6. Solar Collector Studies for Solar Heating and Cooling Applications \$ 41K

DOE Contact - Carl Conner (202) 252-8156
Springborn Labs (DOE Contract No. DE-ACO4-78CS35359)
Bernard Baum (203) 749-8371

Evaluating weather-resistant, low-cost glazing and housing materials that will have a lifetime of up to twenty (20) years under varying stress and high (300°F) temperature conditions. Screening surface etching processes and anti-reflective coatings to reduce reflection losses and increase transmission of plastic glazing. Developing coatings and films for UV protection of plastics.

Keywords: Coatings and Films, Radiation Effects

7. Development of Selective Surfaces

\$ 90K

DOE Contact - Carl Conner (202) 252-8156
Telic Corp. (DOE Contract No. DE-ACO4-80AL13116)
John Thorton (213) 828-7449

Developing the materials and technology needed for producing inexpensive and durable solar selective coatings in a continuous or semicontinuous mode on plates or metal strips. Planar magnetron sputtering is the process being used. An important task of this project is the preparation of continuously-coated strips which are to be provided to interested manufacturers for the fabrication of collectors, and to be tested in the field by firms working in the solar industry.

Keywords: Coatings and Films, Materials Processing

8. Improved Solar Collector Sealants

\$141K

DOE Contact - Carl Conner (202) 252-8156
Westinghouse (DOE Contract No. DE-ACO4-78CS15362)
Morris Mendelsohn (412) 256-3397

Studying the properties of several possible solar collector sealants, and choosing the best candidates. Studying the effects of breathing in flate-plate thermal collectors. Improving the long-term performance of the best candidates by chemical modifications and by reformulation.

Keywords: Seals and Bearings, Materials Characterization, Elastomers and Polymers

Passive and Hybrid Solar Energy Division

This program has two principal thrust: (1) development of new materials, products and systems for buildings and community systems; and (2) transfer of technology developed within the program to the building industry. Within the Division, the Passive Solar Materials & Components Program funds R&D and testing of common and advanced materials, components and assemblies that can improve the performance, reduce the cost, or simplify the design of passive solar heating, cooling, and daylighting systems. Much of this effort consists of financial support of prototype systems presently being developed by industry.

1. Phase-Change Storage/Insulation \$29K

DOE Contact- David Pellish (202) 252-8110
HITEK, Inc. (DOE Contract No. DE-FC02-80CS30523)
Mrs. Charles Bliege (503) 367-6005

Developing a passive thermal battery module which uses phase change materials and whose module size is being optimized for installation, shipping and handling.

Keywords: Transformations

2. Water Storage \$17K

DOE Contact- David Pellish (202) 252-8110
Solar Concept Development Co. (DOE Contract No. DE-FC02-80CS30529)
Richard Bourne (916) 753-1100

Developing a passive waterwall unit for use in new construction. The unit contains a water storage module, acrylic or polycarbonate glazing, night insulation, an insulation controller, and a window actuator.

Keywords: Coatings and Films

3. Interior Window Insulation \$59K

DOE Contact- David Pellish (202) 252-8110
Solar Systems Design Inc. (DOE Contract No. DE-FC02-80CS30531)
Robert Mitchell (518) 767-3100

Developing a lightweight, movable interior thermal window shutter. Contains a honeycomb insulating core with external skin to withstand impact and abrasion.

Keywords: Alternate Materials

4. Multi-Layer Insulation \$78K

DOE Contact- David Pellish (202) 252-8110
Star Technology Corp. (DOE Contract No. DE-FC02-80CS30532)
Doug Davis (303) 963-1969

Developing an insulating curtain system which utilizes multiple layers of fabric including reflective layers for insulation enhancement.

Keywords: Alternate Materials

Solar Thermal Technology Division

The objective of this program is to establish the technical feasibility and cost readiness of mid- and high-temperature solar concentrating systems. Research is focused upon three classes of systems: (1) linear-focusing distributed receivers (parabolic troughs and hemispherical bowls), (2) point-focusing distributed receivers (parabolic dishes), and (3) central receiver systems.

1. Graded Cermet Selective Absorbers

\$107K

DOE Contact- Frank (Tex) Wilkins (202) 252-1684
Telic Corporation (SERI Subcontract No. XH-9-8260-A)
John Thornton (201) 828-7449

Graded composition platinum/alumina cermets have demonstrated as high-performance selective absorbers. By modifying the graded composition, Telic has produced a cermet of equally high performance at a savings of 70% of the precious metal. Current research is attempting to establish commercial process feasibility.

Keywords: Materials Processing, Alloy Development, Alternate Materials

2. Natural Weathering Exposure

\$25K

DOE Contact- Frank (Tex) Wilkins (202) 252-1684
DSET (SERI Subcontract No. XJ-9-8215)
Tom Anderson (602) 456-7356

Conducting tests on the effect of natural weathering exposure on reflectors, glazings and absorbers. Included are commercially-produced materials foric baseline data, and laboratory materials which are the result of R&D efforts. Exposure include 45° south-facing racks and EMMAQUA (equatorial-mounted, mirror-augmented, water sprayed) 8X concentrators.

Keywords: Erosion and Wear.

3. Kinetic Corrosion Mechanisms

\$25K

DOE Contact - Frank (Tex) Wilkins (202) 252-1684
University of Utah (SERI Subcontract No. XP-0-8046-1)
Charles H. Pitts (801) 581-5157

Determination of a parametric model describing passivation and corrosion kinetics of a typical austenitic, Type-316 stainless steel, and a typical ferritic steel (Fe-9 Cr-1Mo) is the primary task of this contract. This model includes the effects of cyclic temperatures and variable electrolyte composition, and will allow prediction of corrosion rates.

Keywords: Corrosion

4. Polymer Metalization

\$90K

DOE Contact - Frank (Tex) Wilkins (202) 252-1684
SRI International (SERI Subcontract No. XP-9-8127-i)
Sharon Brauman (415) 859-2737

Investigating the interactions between polymers and metallized reflective films. Metallization is by electrolytic deposition. Environmental stress includes increased temperature, humidity and cyclic thermal conditions. Testing includes optical and mechanical examination.

Keywords: Elastomers and Polymers, Materials Characterization, Materials Processing

5. Polymer Protective Laminates

\$68K

DOE Contact - Frank (Tex) Wilkins (202) 252-1684
Springborn Laboratories (DOE Subcontract No. DE-AC01-79)
Bernard Baum 749-8371

Polymers typically are deficient in one or more optical/physical properties. By lamination of polymers, a composite material with higher performance can be prepared. This contract is investigating laminated composites for use as reflectors or transmitters.

Keywords: Elastomers and Polymers, Materials Characterization

6. Mirror Environmental Stress Matrix

\$190K

DOE Contact - Frank (Tex) Wilkins (202) 252-1684
SERI, Battelle Pacific Northwest labs, Sandia National Labs - Livermore, Jet Propulsion Labs, Sandia National Labs - Albuquerque
Pat Call (303) 231-1931

A testing matrix has been devised to compare mirrors developed in various laboratories to those commercially available. Detailed characterization will allow insight into the degradation processes. In addition, developing alternate mirrors using such metal backings as aluminum, tantalum, titanium, nickel and chromium.

Keywords: Materials Characterization, Erosion and Wear, Alloy Development

7. Molten Salt Corrosion

\$520K

DOE Contact - Frank (Tex) Wilkins (202) 252-1684
Sandia National Labs - Livermore
Dan Dawson (415) 422-2953

Molten nitrate salts are a prime candidate for heat transfer and storage media for central receiver systems. Present research is attempting to qualify Incoloy 800 for this purpose. Slow strain rate, isothermal fatigue, and inducing cyclic thermal strains are among the experimental testing techniques.

Keywords: Corrosion

8. Silver/Glass Mirror Degradation

\$200K

DOE Contact - Frank (Tex) Wilkins (202) 252-1684
Sandia National Labs - Livermore
John Vitko (415) 422-2820

This contract is investigating mechanisms of silver/glass reflector degradation. Identification of the aggressive species and modification of mirror construction are being pursued in order to minimize reflected energy loss from the element.

Keywords: Erosion and Wear

Appendix H: Office of Alcohol Fuels

This office is sponsoring R&D aimed at providing the technology base needed for production of economically-competitive alcohol fuels. The current focus of the program is on long-term improvements in process technologies for the production of alcohol from wood, for cellulose fermentation processes, and for multifuel and hybrid engines. Funding is given for FY 1981

1. Membrane Development for Low-Energy Separations \$ 325K

DOE Contact - Richard Moorer (202) 252-1277
SERI
Paul Schissel (303) 231-1000

Studying the mechanisms of membrane fouling and degradation, and development of new membrane systems specifically tailored for use in alcohol production.

Keywords: Elastomers and Polymers

2. Removal of Alcohol by Selective Absorption \$ 35K

DOE Contact - Richard Moorer (202) 252-1277
Whittaker Corp., Shock Hydrodynamics Division (Contract No. B-9189-4)
Emil Lawton (213) 985-6940

Developing an imbibitive polymer which will efficiently remove alcohol from water by absorption.

Keywords: Elastomers and Polymers

3. Development of Ethanol-Selective Membranes \$ 50K

DOE Contact - Richard Moorer (202) 252-1277
Southern Research Institute (Contract No. B-9189-3)
Robert Lacey (205) 323-6592

Developing ethanol-selective membranes that combine high selectivities for ethanol over water with low resistances to the transfer of the permeating species, ethanol or water. The approach involved the formation of a thin ethanol-selective layer on the surface of a low-resistance substrate either by a method involving direct chemical treatment of the low-resistance substrates or by a method involving ultrafiltration of ethanol-selective polymers in and onto substrates, followed by cross-linking to effect firm attachment.

Keywords: Elastomers and Polymers, Coatings and Films

Appendix I: Office of Military Application

The Office of Military Application, under the Assistant Secretary for Defense Programs, directs the research and development, testing, and production of nuclear weapons. Weapon research and development is conducted primarily at the Department of Energy's three nuclear weapon laboratories: Lawrence Livermore National Laboratory (LLNL), Livermore, California; Los Alamos National Laboratory (LANL), Los Alamos, New Mexico; and Sandia National Laboratories at Albuquerque, New Mexico (SNLA) and Livermore, California (SNLL). Weapons production is conducted at seven government-owned, contractor operated plants.

The objectives of the materials research sponsored by the program are to develop materials and materials technology for national security uses. The research is directed toward basic material science, the understanding and development of advanced materials and fabrication technology, and the development of materials and processes required to produce nuclear and non-nuclear parts.

Materials and process development activities emphasize the balance between research and development necessary to provide materials compatible with the extreme environments and performance requirements associated with nuclear ordnance. Detailed knowledge of materials and their behavior often provides the only way to eliminate problems associated with their use and achieves the objectives of functionability, reliability, and longevity. The ability to investigate, characterize, recognize, and develop materials has enabled the weapons program to meet development scheduled for warheads that have remained in the Nation's stockpile with minimum maintenance, maximum safety, and high reliability.

<u>Sandia National Laboratories-Livermore</u>	<u>FY 1981</u>	<u>FY-1982</u>
---	----------------	----------------

7. <u>Hydrogen Compatibility of Materials</u>	\$1200K	\$1200K
---	---------	---------

DOE Contact - W. G. Collins (301) 353-5494; FTS 233-5494
 Sandia National Laboratories-Livermore (Contract No. DE-AC04-76DP00789)
 David M. Schuster (415) 422-2166; FTS 532-2166

This is an interdisciplinary study to: (1) identify and understand the mechanisms of hydrogen embrittlement; (2) characterize the hydrogen compatibility of several austenitic stainless steels; (3) develop techniques to produce structures for hydrogen service, i.e., barrier technology and near net-shape processing.

Keywords: Hydrogen Effects on Materials, Hydrogen Embrittlement, Hydrogen Permeation, Net-Shape Processing.

8. <u>Electrochemical Fabrication</u>	\$ 250K	\$ 250K
---------------------------------------	---------	---------

DOE Contact - W. G. Collins (301) 353-5494; FTS 233-5494
 Sandia National Laboratories-Livermore (Contract No. DE-AC04-76DP00789)
 David M. Schuster (415) 422-2166; FTS 532-2166

Electrodeposition from aqueous solutions of Au, Cu, and Ni is being studied with a focus on the relationship between critical process variables and the mechanical and physical properties of the deposit. Another activity is the development and implementation of a high-speed electrodeposition process which would preserve the properties of coatings deposited at lower rates.

Keywords: Coatings and Films, Materials Processing, Electrodeposition, Gold Copper, Nickel

9. <u>Interdisciplinary Study of Weldments (WELDWOG)</u>	\$ 500K	\$ 500K
--	---------	---------

DOE Contact - W. G. Collins (301) 353-5494; FTS 233-5494
 Sandia National Laboratories-Livermore (Contract No. DE-AC04-76DP00789)
 David M. Schuster (415) 422-2166; FTS 532-2166

Welds consist of modified microstructures and heterogeneous regions. Therefore, no matter how thoroughly we characterize the base metal, the process of joining subsections into assemblies produces behavior that cannot be predicted reliably by any means presently available. We have initiated an interdisciplinary program whose goal is to develop means to predict metallurgical and mechanical behavior of weldments. This goal requires state-of-the-art computational capability. The objectives for WELDWOG are:

1. Predict and control residual, stress and distortion.
2. Predict metallurgical state and associated behavior.
3. Predict and control mechanical flaws.
4. Predict weldability from base metal properties.

Keywords: Weldments, Modified Microstructures, Interdisciplinary Program, Weldability.

FY 1981 FY-1982

10. Coatings and Films

\$ 250K \$ 250K

DOE Contact - W. G. Collins (301) 353-5494; FTS 233-5494
Sandia National Laboratories-Albuquerque (Contract No. DE-AC04-76DP00789)
D. M. Mattox (505) 844-8333; A. W. Mullendore (505) 844-5353;
J. K. G. Panita (505) 844-8604

Engineering applications, deposition technology development, and basic scientific studies are being pursued in the areas of sputter deposition, ion plating, vacuum deposition, chemical vapor deposition, and plasma spraying. Coatings as hydrogen barriers, electrical contacts, insulators, bonding agents, corrosion inhibitors, wear surfaces, and monolithic structures are being developed and studied. Emphasis is on materials preparation and characterization.

Keywords: Coatings and Films, Materials Development, Materials Characterization, Materials Application

11. Erosion and Wear in Mechanical Components

\$ 200K \$ 200K

DOE Contact - W. G. Collins (301) 353-5494; FTS 233-5494
Sandia National Laboratories-Albuquerque (Contract No. DE-AC04-76DP00789)
R. E. Cuthrell (505) 844-7195; L. E. Pope (505) 844-5041; F. G. Yost (505) 844-8358; M. F. Smith (505) 844-8333

The mechanisms of erosion and wear in mechanical and electromechanical components are being studied. Techniques and materials for reducing erosion and wear are being evaluated. Techniques include coatings, ion implantation, lubrication, and materials selection. Studies of chemical and contamination effects on surface deformation and fracture are assisting in defining the mechanisms of erosion and wear.

Keywords: Erosion and Wear, Surface Deformation, Surface Fracture
Copper, Nickel

12. Cleaning Procedures and Residual Contamination

\$ 100K \$ 100K

DOE Contact - W. G. Collins (301) 353-5494; FTS 233-5494
Sandia National Laboratories-Albuquerque (Contract No. DE-AC04-76DP00789)
N. E. Brown (505) 844-2747; S. L. Erickson (505) 844-2631; R. Sowell (505) 844-1038

The efficiencies of various types of cleaning procedures are being determined by measuring residual contaminations following use of the procedures. The procedures include detergent cleaning, solvent cleaning, ultrasonic cleaning, and vapor degreasing. New methods for the analysis of residual contamination are being developed.

Keywords: Materials Processing, Contamination, Cleaning, Detergent, Solvent, Ultrasonic, Vapor Degreasing

	<u>FY 1981</u>	<u>FY-1982</u>
13. <u>Physical and Chemical Aging Mechanisms in Polymers</u>	\$ 250K	\$ 250K

DOE Contact - W. G. Collins (301) 353-5494; FTS 233-5494
 Sandia National Laboratories-Albuquerque (Contract No. DE-AC04-76DP00789)
 J. G. Curro (505) 844-3963; J. A. Sayre (505) 844-6631; K. T. Gillen
 (505) 844-7494; R. L. Clough (505) 844-0324

The mechanisms of physical and chemical aging in polymers are being studied to provide a basis for predicting long-term reliability of weapons. The relationship between structure and properties of rubber modified epoxies are being studied to develop process controls. Rubber modified epoxies are used extensively as a tough encapsulant in weapons.

Keywords: Elastomers and Polymers, Encapsulants, Aging, Process Controls, Epoxies, Reliability

14. <u>High Strength Uranium Alloys</u>	\$ 50K	\$ 50K
---	--------	--------

DOE Contact - W. G. Collins (301) 353-5494; FTS 233-5494
 Sandia National Laboratories-Albuquerque (Contract No. DE-AC04-76DP00789)
 K. H. Eckelmeyer (505) 844-7775; A. D. Romig (505) 844-8358

Thermal mechanical treatments are being investigated to provide high strength uranium alloys with good ductility and corrosion resistance. Candidate alloys are U-3/4%Ti, U-2%Mo, and U-2 1/4Nb, a substantial increase in the strengths of uranium alloys plus increased flexibility in processing should result from these studies.

Keywords: Alloy Development, Uranium, Corrosion, Strengthening Mechanisms

15. <u>Welding Processes</u>	\$ 200K	\$ 200K
------------------------------	---------	---------

DOE Contact - W. G. Collins (301) 353-5494; FTS 233-5494
 Sandia National Laboratories-Albuquerque (Contract No. DE-AC04-76DP00789)
 J. L. Jellison (505) 844-2747; G. A. Knorovsky (505) 844-1109

The pulsed laser and pulsed tungsten inert gas arc processes are being studied for the production of miniature fusion welds for component envelope closure. Weld processes are tailored to provide joints with optimal mechanical properties. Solid phase bonding is being developed for production of joints between dissimilar metals and where fusion welding is impractical.

Keywords: Joining Methods, Solid Phase Welding, Pulsed Laser Welding, Pulsed Tungsten Inert Gas Welding, Dissimilar Metal Joints, Miniature Welds

FY 1981 FY-1982

16. Improved Methods of Materials Characterization \$1500K \$1500K

DOE Contact - W. G. Collins (301) 353-5494; FTS 233-5494
Sandia National Laboratories-Albuquerque (Contract No. DE-AC04-76DP00789)
R. E. Whan (505) 844-8904; K. E. Eckelmeyer (505) 844-7775; J. A. Borders
(505) 844-8855

New and improved methods of materials characterization are being developed and implemented. Automated data acquisition and instrument control are being added to existing instrumentation in order to give higher accuracy and reliability and to improve productivity by out-of-hours data acquisition and processing. New facilities include a high resolution transmission electron microscope, scanning Auger microprobe, Fourier transform infrared spectrometer, and a laser Raman microprobe. Improved capabilities include automated electron microprobe, x-ray diffraction, and emission spectroscopy equipment and automated in situ electron diffraction data analysis.

Keywords:

17. Ceramics and Glasses \$1200K \$ 1500

DOE Contact - W. G. Collins (301) 353-5494; FTS 233-5494
Sandia National Laboratories-Albuquerque (Contract No. DE-AC04-76DP00789)
R. J. Eagan (505) 844-4069; C. J. Brinker (505) 844-3552; J. J. Mecholsky
(505) 844-0787; J. A. Wilder (505) 844-1332

A family of glass ceramics is being developed to match the expansion coefficients of most materials of technical interest. Processing schedules provide hermetic seals to metal. Fracture analyses and structural studies point toward tougher materials for severe environments. The sol-tel processing promises unique applications of glass as a coating in critical electrical components.

Keywords: Ceramics, Glass, Glass Ceramics, Seals, Sol-Gel, Fracture Toughness

18. Uranium Corrosion \$ 250K \$ 250K

DOE Contact - W. G. Collins (301) 353-5494; FTS 233-5494
Sandia National Laboratories-Albuquerque (Contract No. DE-AC04-76DP00789)
L. J. Weirick (505) 844-1016; B. C. Bunder (505) 844-8940

The mechanism of uranium corrosion in moist air is being investigated using weight loss measurements and mass spectroscopy. Chemical and electrochemical and surface techniques are used to evaluate and understand corrosion of glasses used in sealing applications to aluminum and battery contact pins. Variables such as glass composition, pH, and solution chemistry are under study.

Keywords: Corrosion, Uranium, Actuators, Glass Corrosion

FY 1981 FY-1982

19. Organic Adhesives and Lubricants

\$ 200K \$ 200K

DOE Contact - W. G. Collins (301) 353-5494; FTS 233-5494
Sandia National Laboratories-Albuquerque (Contract No. DE-AC04-76DPO0789)
L. A. Harrah (505) 844-6847; J. A. Kelber (505) 844-3408; L. E. Pope (505)
844-5041

Model polymers are being studied to determine the actual bonding between organic adhesive and metal substrate through the use of detailed analysis of Auger line shapes. Factorial experiments are designed to evaluate the relative importance of several parameters influencing moving friction such as contact force, material hardness, temperature, environment, etc.

Keywords: Adhesives, Bonding, Auger Line Shapes, Friction, Wear

20. Real-Time Radiography Development

\$ 60K \$ 100

DOE Contact - W. G. Collins (301) 353-5494; FTS 233-5494
Sandia National Laboratories-Albuquerque (Contract No. DE-AC04-76DPO0789)
F. A. Hasenkamp (505) 844-5334

Real-time video recordings of radiography of various weapons materials/ environmental tests are required. A complete real-time radiograph image processing facility is being established and is used on all weapon systems tests.

Keywords: Nondestructive Evaluation (NDE), Materials Processing and Characterization, Weapons Environmental Test Diagnostics

21. Ultrasonic Phased Array Test and Data Processing System \$ 100K \$ 150K

DOE Contact - W. G. Collins (301) 353-5494; FTS 233-5494
Sandia National Laboratories-Albuquerque (Contract No. DE-AC04-76DPO0789)
J. H. Gieske (505) 844-6346

Development of digital scanning and focusing of ultrasonic wave to enhance testing. Development of acoustic imaging to better define size and shape of flaws.

Keywords: Nondestructive Evaluation (NDE), Materials Characterization

	<u>FY 1981</u>	<u>FY-1982</u>
<u>Los Alamos National Laboratory</u>		
22. <u>Adhesives Development</u>	\$ 120K	\$ 130K
DOE Contact - W. G. Collins (301) 353-5494; FTS 233-5494 Los Alamos National Laboratory (Contract No. W-7405-eng-36) J. M. Dickinson (505) 667-4365; FTS 843-4365		
Lamination-bonding of Kapton/Aluminum to stainless steel grids for electron beam windows. Electron gun accelerator columns in laser amplifiers consisting of alternating aluminum and cast epoxy rings.		
Keywords: Adhesives		
23. <u>Polymers and Adhesives</u>	\$ 750K	\$ 795K
DOE Contact - W. G. Collins (301) 353-5494; FTS 233-5494 Los Alamos National Laboratory (Contract No. W-7405-eng-36) W. A. May, Jr. (505) 667-6362; FTS 843-6362		
Development of fabrication processes and evaluation and testing of commercial materials for weapons programs. Development of plastic-bonded composites, cushioning materials, compatible adhesives.		
Keywords: Adhesives, Polymers		
24. <u>Plutonium Alloy Development</u>	\$1060K	\$1250K
DOE Contact - W. G. Collins (301) 353-5494; FTS 233-5494 Los Alamos National Laboratory (Contract No. W-7405-eng-36) D. R. Harbur. (505) 667-2556; FTS 843-2556		
Development of new alloys of plutonium for weapons applications; includes casting, mechanical working, and stability studies. Measurements of resistivity, thermal expansion, and differential thermal analysis are made to assess fabrication processing and stability.		
Keywords: Alloy Development, Plutonium Phase Stability		
25. <u>Mechanical Properties and Alloy Development</u>	\$ 200K	\$ 215K
DOE Contact - W. G. Collins (301) 353-5494; FTS 233-5494 Los Alamos National Laboratory (Contract No. W-7405-eng-36) R. N. R. Mulford (505) 667-4665; FTS 843-4665		
Thermomechanical processing of plutonium allows to optimize mechanical properties. Study of complex microstructures, grain refinement, and deformation-induced transformations.		
Keywords: Alloy Development, Mechanical Properties, Plutonium		

	<u>FY 1981</u>	<u>FY-1982</u>
26. <u>Amorphous Actinides</u>	\$ 90K	\$ OK

DOE Contact - W. G. Collins (301) 353-5494; FTS 233-5494
 Los Alamos National Laboratory (Contract No. W-7405-eng-36)
 R. N. R. Mulford (505) 667-4665; FTS 843-4665

Intermetallic compounds like U_6Fe and Pu_5Ga_3 have been produced in the amorphous state by fission fragment bombardment from neutron irradiation. Physical properties have been measured using differential scanning calorimetry.

Keywords: Alternate Materials, Amorphous, Irradiation

27. <u>Inorganic Materials Synthesis</u>	\$ 60K	\$ OK
--	--------	-------

DOE Contact - W. G. Collins (301) 353-5494; FTS 233-5494
 Los Alamos National Laboratory (Contract No. W-7405-eng-36)
 R. J. Bard (505) 667-4691; FTS 843-4691

Develop synthetic materials using scull-melting techniques for encapsulation of nuclear waste.

Keywords: Waste Management, Nuclear Waste

28. <u>Metallic Glasses</u>	\$ 90K	\$ 75K
-----------------------------	--------	--------

DOE Contact - W. G. Collins (301) 353-5494; FTS 233-5494
 Los Alamos National Laboratory (Contract No. W-7405-eng-36)
 R. J. Bard (505) 667-4691; FTS 843-4691

Surface modification of U alloys by laser and electron-beam treatments. Also experimental and calculational modeling studies of atomic-mobility phenomena and irradiation effects in metallic glasses ($Fe_{40}Ni_{40}P_{14}B_6$ and $Pd_{80}Ge_{20}$).

Keywords: Metallic Glasses, Surface Modification, Rapid-Solidification Technology, Irradiation Effects.

29. <u>Superhard Materials</u>	\$ 56K	\$ 50K
--------------------------------	--------	--------

DOE Contact - W. G. Collins (301) 353-5494; FTS 233-5494
 Los Alamos National Laboratory (Contract No. W-7405-eng-36)
 J. M. Dickinson (505) 667-4365; FTS 843-4365

B_4C has been added to conventional W-Ni-Fe alloys to improve hardness, wear resistance, and resistance to deformation. These alloys have been developed to eliminate the use of critical materials such as Co in high hardness materials.

Keywords: Alternate Materials, Boron Carbide, Hot Processing

FY 1981 FY-1982

30. Surface Studies

\$ 420K \$ 290K

DOE Contact - W. G. Collins (301) 353-5494; FTS 233-5494
Los Alamos National Laboratory (Contract No. W-7405-eng-36)
W. P. Ellis (505) 667-4043; FTS 843-4043

Studies of surface structures, gas-solid reactions and catalysis. Surface analytical tools used to characterize surface structure, detect and identify impurities, and obtain information about valence band electrons.

Keywords: Catalysts, Surface Science, Gas-Solid Reactions

31. Gas-Solid Reactions in Actinides

\$ 90K \$ 115K

DOE Contact - W. G. Collins (301) 353-5494; FTS 233-5494
Los Alamos National Laboratory (Contract No. W-7405-eng-36)
R. N. R. Mulford (505) 667-4665; FTS 843-4665

Reaction chemistry of actinide metal and alloy surfaces, attack by hydrogen, nature of catalytic processes.

Keywords: Catalysts, Actinides

32. Bulk Glass Fabrication Technology

\$ 150K \$ 50K

DOE Contact - W. G. Collins (301) 353-5494; FTS 233-5494
Los Alamos National Laboratory (Contract No. W-7405-eng-36)
J. M. Dickenson (505) 667-4365; FTS 843-4365

Casting and hot forming into hemispheres, disks, plates, sheets, and rods. Composition is controlled to yield good strength, hardness, nuclear requirements, or chemical durability.

Keywords: Glass, Hot Forming

33. Slip Casting of Ceramics

\$ 100K \$ 120K

DOE Contact - W. G. Collins (301) 353-5494; FTS 233-5494
Los Alamos National Laboratory (Contract No. W-7405-eng-36)
J. M. Dickinson (505) 667-4365; FTS 843-4365

Slip casting of many ceramics including alumina and magnesia. Technology uses colloidal chemistry and powder characterization theory along with materials engineering.

Keywords: Ceramics, Slip Casting, Alumina

	<u>FY 1981</u>	<u>FY-1982</u>
34. <u>Ceramics Technology</u>	\$ 150K	\$ 100K

DOE Contact - W. G. Collins (301) 353-5494; FTS 233-5494
 Los Alamos National Laboratory (Contract No. W-7405-eng-36)
 J. M. Dickinson (505) 667-4365; FTS 843-4365

Castable ceramics for molds, crucibles, liners, and electrical insulators.
 Moldable ceramics of alumina with silica and plastic binders. Ceramic heat
 pipes. Design and properties of brittle materials.

Keywords: Ceramics, Castable Ceramics, Heat Pipes, Brittle Materials

35. <u>Glass and Ceramic Sealing Technology</u>	\$ 90K	\$ 100K
---	--------	---------

DOE Contact - W. G. Collins (301) 353-5494; FTS 233-5494
 Los Alamos National Laboratory (Contract No. W-7405-eng-36)
 J. M. Dickinson (505) 667-4365; FTS 843-4365

Ceramic-to-ceramic and ceramic-to-metal seals. Custom alumina combustion tubes,
 plug closures for alumina and silicon carbide heat pipes, high-voltage feed-
 throughs, beryllia klystron window.

Keywords: Glass, Ceramics, Seals

36. <u>Bulk Glass Fabrication Technology</u>	\$ 150K	\$ 50K
--	---------	--------

DOE Contact - W. G. Collins (301) 353-5494; FTS 233-5494
 Los Alamos National Laboratory (Contract No. W-7405-eng-36)
 J. M. Dickenson (505) 667-4365; FTS 843-4365

Development of ceramic materials with improved strength and fracture toughness using
 SiC or Si₃N₄ whiskers in a glass or ceramic matrix.

Keywords: Ceramics, Glass, Whiskers, Composites

37. <u>New Hot Pressing Technology</u>	\$ 150K	\$ 200K
--	---------	---------

DOE Contact - W. G. Collins (301) 353-5494; FTS 233-5494
 Los Alamos National Laboratory (Contract No. W-7405-eng-36)
 J. M. Dickinson (505) 667-4365; FTS 843-4365

Hot pressing of ceramic components for laboratory use. Typical materials are
 carbon-carbon composites, B₄C composites and metal filters.

Keywords: Ceramics, Hot Pressing, Composites, Metal Filters

- | | <u>FY 1981</u> | <u>FY-1982</u> |
|--|----------------|----------------|
| 38. <u>Glass and Ceramic Coatings</u> | \$ 70K | \$ 80K |
| DOE Contact - W. G. Collins (301) 353-5494; FTS 233-5494
Los Alamos National Laboratory (Contract No. W-7405-eng-36)
J. M. Dickinson (505) 667-4365; FTS 843-4365 | | |
| Develop vitreous enamels and general ceramic coatings to provide radiation-hardened electrically-insulating components for accelerator technology. | | |
| Keywords: Enamels, Ceramics Coatings | | |
| 39. <u>Plasma-Flame Sprayng Technology</u> | \$ 75K | \$ 140K |
| DOE Contact - W. G. Collins (301) 353-5494; FTS 233-5494
Los Alamos National Laboratory (Contract No. W-7405-eng-36)
J. M. Dickinson (505) 667-4365; FTS 843-4365 | | |
| Metallic and/or ceramic coatings or free-standing shapes. Coatings for radiation hardening, radiochemical detectors, temperature resistance, oxidation and corrosion resistance, light absorbence, and electrical conductance. Micro-structure, uniformity, and density of coatings. | | |
| Keywords: Coatings, Metals, Ceramics, Plasma-Flame Spraying | | |
| 40. <u>Physical Vapor Deposition and Surface Analysis</u> | \$ 150K | \$ 165K |
| DOE Contact - W. G. Collins (301) 353-5494; FTS 233-5494
Los Alamos National Laboratory (Contract No. W-7405-eng-36)
J. M. Dickenson (505) 667-4365; FTS 843-4365 | | |
| Physical vapor deposition and sputtering to produce materials for structural applications. Doped in situ laminates of aluminum and Al_xO_y and composites of Ta - TaC_x for high strength and smooth surface finish. | | |
| Keywords: Coatings, Physical Vapor Deposition, Sputtering, Aluminum, Tantalum | | |
| 41. <u>Target Coatings</u> | \$ 300K | \$ 350K |
| DOE Contact - W. G. Collins (301) 353-5494; FTS 233-5494
Los Alamos National Laboratory (Contract No. W-7405-eng-36)
J. M. Dickinson (505) 667-4365; FTS 843-4365 | | |
| Single and multilayer metallic coatings, smooth and uniform in thickness. Substrates are hollow or solid small spheres of metal glass, or plastic. Electrolytic and autocatalytic processes being investigated. | | |
| Keywords: Coatings, Thin Films | | |

	<u>FY 1981</u>	<u>FY-1982</u>
42. <u>Chemical Vapor Deposition Coatings</u>	\$ 200K	\$ 230K

DOE Contact - W. G. Collins (301) 353-5494; FTS 233-5494
 Los Alamos National Laboratory (Contract No. W-7405-eng-36)
 J. M. Dickinson (505) 667-4365; FTS 843-4365

Low-temperature coatings on hollow, spherical substrates. Low pressure conditions for deposition in fluidized bed. Coatings of tungsten, molybdenum, rhenium, nickel, and Mo₂C.

Keywords: Coatings, Chemical Vapor Deposition, Fluidized Bed

43. <u>Radiochemistry Detector Coatings</u>	\$ 150K	\$ 160K
---	---------	---------

DOE Contact - W. G. Collins (301) 353-5494; FTS 233-5494
 Los Alamos National Laboratory (Contract No. W-7405-eng-36)
 J. M. Dickinson (505) 667-4365; FTS 843-4365

Physical vapor deposition of coating for radiochemical detectors. Metallic and nonmetallic coatings.

Keywords: Coatings, Radiochemical Detectors, Physical Vapor Deposition

44. <u>Parylene Coating Development</u>	\$ 75K	\$ 110K
---	--------	---------

DOE Contact - W. G. Collins (301) 353-5494; FTS 233-5494
 Los Alamos National Laboratory (Contract No. W-7405-eng-36)
 J. M. Dickenson (505) 667-4365; FTS 843-4365

Vacuum vaporization of p-xylene dimer and thermal pyrolysis with in situ polymerization on a substrate. Coatings produce good physical and chemical resistance and forms strong vapor barrier.

Keywords: Coatings, Parylene, Polmers

45. <u>Structural Polmer Castings</u>	\$ 300K	\$ 350K
---------------------------------------	---------	---------

DOE Contact - W. G. Collins (301) 353-5494; FTS 233-5494
 Los Alamos National Laboratory (Contract No. W-7405-eng-36)
 J. M. Dickinson (505) 667-4365; FTS 843-4365

Large complex castings of polymers for a variety of structural applications. Require electrical and structural properties. Polyurethanes with additives for special mechanical and physical properties.

Keywords: Polymers, Polyurethane, Castings

- | | <u>FY 1981</u> | <u>FY-1982</u> |
|--|----------------|----------------|
| 46. <u>Mechanical Properties of Uranium</u> | \$ 125K | \$ 150K |
| DOE Contact - W. G. Collins (301) 353-5494; FTS 233-5494
Los Alamos National Laboratory (Contract No. W-7405-eng-36)
R. N. Mulford (505) 667-4665; FTS 843-4665 | | |
| Mechanical properties of U-6%Nb at high strain rates. Hydrogen at ppm levels causes drastic reduction in biaxial ductility with very little effect on uniaxial ductility. | | |
| Keywords: Hydrogen, Mechanical Propertis, Uranium, Biaxial, Uniaxial, Ductility | | |
| 47. <u>Moldable Ceramics</u> | \$ 50K | \$ 60K |
| DOE Contact - W. G. Collins (301) 353-5494; FTS 233-5494
Los Alamos National Laboratory (Contract No. W-7405-eng-36)
J. M. Dickinson (505) 667-4365; FTS 843-4365 | | |
| Develop injection and compression molding techniques for Al ₂ O ₃ ceramic shapes with about 25 vol % wax or epoxy binder. Complex ceramic shapes may be molded to final dimensions or near final dimensions and fired to full density. | | |
| Keywords: Moldable Ceramics, Injection Molding, Compression Molding, Near-net-shape Molding. | | |
| 48. <u>Joining Process Development</u> | \$ 100K | \$ 110K |
| DOE Contact - W. G. Collins (301) 353-5494; FTS 233-5494
Los Alamos National Laboratory (Contract No. W-7405-eng-36)
J. M. Dickenson (505) 667-4365; FTS 843-4365 | | |
| Microcomputer technology for process control. Multiaxes programmable control high-voltage electron beam wedler. Fusion welding process includes lasers, electron beam, and gas tungsten arc. | | |
| Keywords: Joining, Welding, Electron Beam, Lasers, Microcomputers | | |
| 49. <u>Explosion Welding</u> | \$ 25K | \$ 30K |
| DOE Contact - W. G. Collins (301) 353-5494; FTS 233-5494
Los Alamos National Laboratory (Contract No. W-7405-eng-36)
J. M. Dickinson (505) 667-4365; FTS 843-4365 | | |
| Develop transition joints between 1100, 3000, and 5000 series Al alloys and 304 stainless steel. Develop computer program to model explosion welding parameters for various material combinations. | | |
| Keywords: Joining, Welding, Explosion Welding | | |

	<u>FY 1981</u>	<u>FY-1982</u>
50. <u>Solid State Bonding</u>	\$ 25K	\$ 30K
<p>DOE Contact - W. G. Collins (301) 353-5494; FTS 233-5494 Los Alamos National Laboratory (Contract No. W-7405-eng-36) J. M. Dickinson (505) 667-4365; FTS 843-4365</p> <p>Develop bonding techniques for seamless ICF targets. Clean surfaces and apply thin interlayers of bonding materials using sputtering techniques. Investigating Al, Ti, and Be with various bonding materials.</p> <p>Keywords: Joining, Solid State Bonding, Sputtering</p>		
51. <u>Materials Characterization Studies</u>	\$ 150K	\$ 50K
<p>DOE Contact - W. G. Collins (301) 353-5494; FTS 233-5494 Los Alamos National Laboratory (Contract No. W-7405-eng-36) R. J. Bard (505) 667-4691; FTS 843-4691</p> <p>Optical metallography, scanning electron microscopy, transmission electron microscopy, x-ray diffraction of metals, alloys, ceramics, graphites, and polymers.</p> <p>Keywords: Materials Characteriation, Electron Microscopy, X-Rays, Metallography.</p>		
52. <u>Nondestructive Evaluation</u>	\$ 840K	\$ 900K
<p>DOE Contact - W. G. Collins (301) 353-5494; FTS 233-5494 Los Alamos National Laboratory (Contract No. W-7405-eng-36) R. Morris (505) 667-6216; FTS 843-6216</p> <p>Betatron radiography, nuclear fluorescence, acoustic emission and scattering, tomographic techniques for nondestructive evaluation. Image enhancement techniques for better resolution and definition.</p> <p>Keywords: Nondestructive Evaluation, Radiography, Acoustic Emission</p>		
53. <u>Low Temperature Electronic Properties</u>	\$ 200K	\$ 200K
<p>DOE Contact - W. G. Collins (301) 353-5494; FTS 233-5494 Los Alamos National Laboratory (Contract No. W-7405-eng-36) R. N. R. Mulford (505) 667-4665; FTS 843-4665</p> <p>Understand electronic properties of materials through their superconducting and magnetic behaviors. Emphasis on actinide elements and their alloys.</p> <p>Keywords: Superconductivity, Magnetism, Actinides, Electronic Properties</p>		

- | | <u>FY 1981</u> | <u>FY-1982</u> |
|---|----------------|----------------|
| 54. <u>Solid State Bonding</u> | \$ 25K | \$ 30K |
| DOE Contact - W. G. Collins (301) 353-5494; FTS 233-5494
Los Alamos National Laboratory (Contract No. W-7405-eng-36)
T. C. Wallace (505) 667-6074; FTS 843-6074 | | |
| Investigations to develop new superconducting materials with high transition temperatures and critical fields. Materials with itinerant magnetic properties are also of interest. | | |
| Keywords: Superconductivity, Magnetism | | |
| 55. <u>Phase Transformations in Pu and Pu Alloys</u> | \$ 225K | \$ 260K |
| DOE Contact - W. G. Collins (301) 353-5494; FTS 233-5494
Los Alamos National Laboratory (Contract No. W-7405-eng-36)
R. N. R. Mulford (505) 667-4665; FTS 843-4665 | | |
| Mechanisms, crystallography, and kinetics of transformations in Pu and alloys. Studies use pressure and temperature dilatometry, optical metallography, and x-ray diffraction. | | |
| Keywords: Transformations, Plutonium | | |
| 56. <u>X-Ray Diffraction of Actinides at High Pressure</u> | \$ 150K | \$ 210K |
| DOE Contact - W. G. Collins (301) 353-5494; FTS 233-5494
Los Alamos National Laboratory (Contract No. W-7405-eng-36)
R. N. R. Mulford (505) 667-4665; FTS 843-4665 | | |
| X-ray diffraction studies of plutonium and americium at pressure using a diamond anvil cell. Compressibility and phase transformations in plutonium and americium are determined. Data relates to f-electron bonding in actinides | | |
| Keywords: Transformations, Actinides, X-Rays, Diamond Anvil Cell | | |
| 57. <u>Neutron Diffraction of Pu and Pu Alloys</u> | \$ 25K | \$ 35K |
| DOE Contact - W. G. Collins (301) 353-5494; FTS 233-5494
Los Alamos National Laboratory (Contract No. W-7405-eng-36)
R. N. R. Mulford (505) 667-4665; FTS 843-4665 | | |
| Neutron diffraction studies on plutonium and its alloys conducted at the Los Alamos WNR pulsed neutron source. Time-of-flight technique used to do diffraction at elevated temperatures and pressures. | | |
| Keywords: Transformations, Plutonium, Neutron Diffraction, Pulsed Neutron Source | | |

APPENDIX J: OFFICE OF DEFENSE WASTE AND BYPRODUCTS MANAGEMENT

Alternative Waste Forms, Canisters and Related Processes Are Being
Developed for Defense High-Level and Transuranic Wastes

FY 1982 \$11 million, Organizationally under NE Prior to FY 1982

HLW FORMS

\$5 million

Alternative Waste Forms and Compositions Developed and characterized

SRL, INEL, PNL, RHO, LLL

HLW PROCESSES

\$6 million

Lab scale, Radioactive Process Development Engineering Scale,

Glasses and Polycrystalline Ceramic Forms

SRL, PNL, LLL, ANL, ORNL, RES

Ray Walton
DP 123
353-3388

Appendix K: Office of Basic Energy Sciences

Materials Sciences Division

The Materials Sciences Division reports to the Director of the Office of Energy Research through the Associate Director for Basic Energy Sciences. The objective of the Materials Sciences program is to conduct fundamental research aimed at increasing the understanding of materials and materials related phenomena of interest to the Department of Energy. Research is conducted primarily at DOE laboratories, universities and to a lesser extent in industry.

This program is basic or long range in nature and is intended to provide the necessary base of materials knowledge ultimately needed to advance our energy technologies. Emphasis is placed on areas where problems are known to exist or are anticipated and on generic areas of fundamental importance. Another aspect of the program is the development and utilization of unique facilities used not only by DOE contractors but also by other laboratory, university, and industry scientists. Among these facilities are several which began operation recently. The Intense Pulsed Neutron Source (IPNS) at Argonne National Laboratory started operation in early FY 1982 and is being used for both neutron scattering and neutron irradiation effects research. The National Synchrotron Light Source (NSLS) at Brookhaven National Laboratory began experimentation in FY 1982. The NSLS provides intense beams of x-radiation and vacuum ultraviolet radiation for research. The nation's highest voltage electron microscope (1.5 MeV) began operation at Lawrence Berkeley Laboratory in FY 1982. An atomic resolution (1.7Å) microscope will be delivered to LBL in FY 1982 and begin operation in FY 1983. Other major facilities used in the Materials Sciences program which are also used by other programs include: The High Flux Beam Reactor (BNL), High Flux Isotope Reactor (ORNL), 1.0 MeV High Voltage Electron Microscope (ORNL), 1.2 MeV High Voltage Electron Microscope/Tandem Accelerator (ANL) and the Microanalysis Center (U. of Illinois). These facilities and others are described in detail in the Materials Sciences Programs annual listing of projects report.

Some of the research is directed at a single energy technology (e.g., photovoltaic materials for direct conversion of solar energy into electricity), whereas other research is applicable to many technologies simultaneously (e.g., the embrittlement of structural materials due to the presence of hydrogen) and still other has more fundamental implications underpinning all materials research (e.g., mechanisms of atomic transport in solids).

At the DOE laboratories, technology and information transfer occurs quickly between the basic and applied programs when they are co-sited at the same laboratory. The Materials Sciences subprogram also supports research at universities and to a lesser extent industrial laboratories, taking advantage of the unique expertise of researchers at each of the different types of institutions. Coordination of DOE's applied materials development efforts with the Materials Sciences program takes place primarily through the DOE

Energy Materials Coordinating Committee (EMaCC), but also through Materials Sciences Research Assistance Task Forces, technology meetings, and less formal contacts among staff members. The program utilizes workshops and reports of its Council on Materials Science (a non-governmental body with representatives from academia, industry, and DOE laboratories) to help focus on critical issues. In FY 1981, the Council reviewed research needs and opportunities in the areas of radiation effects and theory of condensed matter/role of computation. For FY 1982, two areas: nuclear waste and materials research at high pressure will be reviewed. Reports of these Panel meetings are available from the Materials Sciences office. Many of the past reports have been published in the open literature.

The Materials Sciences Division has three major categories which represent the disciplines involved and the administrative units in the program: A) Metallurgy and Ceramics, B) Solid State Physics, and C) Materials Chemistry. The following description of the program is separated into those three categories. Further information can be obtained by contacting Dr. L. C. Ianniello, Director, Division of Materials Sciences (301-353-3427) or other staff members:

Dr. M. C. Wittels, Branch Chief for Solid State Physics
and Materials Chemistry

Dr. T. A. Kitchens, Solid State Physicist

Dr. S. M. Wolf, Metallurgist

Dr. R. J. Gottschall, Ceramist

A description of all of the Division's projects is given in an annual summary report--the most recent is Materials Sciences Programs, FY 1982, DOE/ER-0143. The overall funding for the Division in FY 1981 and FY 1982 is given in Table I:

Table I - Materials Sciences Budget (\$M)

	<u>FY 1981</u>	<u>FY 1982</u>
Operating	87.5	94.5
Equipment	7.1	7.9
Construction	<u>0.3</u>	<u>0.6</u>
Total Materials Sciences	94.9	103.0

Tables II, III, and IV provide information on contractor allocation (II), selected areas of research (III), and economic sector (IV) for the last complete fiscal year FY 1982 for the operating funds.

Table II - Operating Funds by Contractor

	FY 1982 Total <u>Program (%)</u>
Ames Laboratory	7.18
Argonne National Laboratory	19.66
Brookhaven National Laboratory	14.90
Idaho National Engineering Laboratory	0.39
Illinois, University of (Materials Research Laboratory)	2.87
Lawrence Berkeley Laboratory	6.89
Lawrence Livermore National Laboratory	1.35
Los Alamos National Laboratory	3.30
Oak Ridge National Laboratory	20.11
Pacific Northwest Laboratory	2.02
Sandia National Laboratories	3.06
Solar Energy Research Institute	0.29
Contract Research (Unsolicited Proposals)	<u>17.98</u>
	100.00

Table III - Operating Funds by
Selected Areas of Research (FY 1982)

	Number of Projects (Total=4000) <u>(%)</u>	Total Program \$ <u>(%)</u>
(a) Materials		
Polymers	6.1	2.3
Ceramics	47.3	25.0
Semiconductors	16.4	10.1
Hydrides	9.7	6.2
Ferrous Metals	23.7	13.9
(b) Technique		
Neutron Scattering	11.8	20.0
Theory	21.7	10.4
(c) Phenomena		
Catalysis	10.2	6.9
Corrosion	13.3	10.8
Diffusion	22.0	9.1
Superconductivity	9.7	6.1
Strength	20.5	9.9
(d) Environment		
Radiation	22.5	21.6
Sulphur-Containing	6.1	4.0
High Temperature	22.2	15.0

Table IV - Funding by Economic Sector (FY 1981)

	<u>Percent</u>
<u>Universities</u> (including those DOE university laboratories where graduate students are involved in a large extent, e.g., LBL and AMES	34.8
<u>DOE Laboratories</u>	64.7
<u>Industry and other</u>	<u>0.5</u>
	100.0

A. Metallurgy and Ceramics FY 1981 (\$35.5M) FY 1982 (\$40.5M)

The objective of research conducted under the metallurgy and ceramics category is primarily to better understand how metallic and ceramic materials behavior/properties are related and controlled by structure and processing conditions. By processing is meant the methods and techniques used to prepare, form or fabricate materials. Important properties of materials such as fracture, plastic flow, superconductivity, corrosion resistance, radiation resistance, and transport phenomena all depend on structure. As a consequence of this improved understanding, better materials and a greater ability to predict behavior of materials in energy systems will eventually be possible. Although basic in nature, the program is centered around research areas deemed to be of greatest interest for energy systems. For example, there is within the metallurgy and ceramics category a strong emphasis on hydrogen effects, radiation effects, corrosion, creep and high temperature deformation, high temperature ceramics, and superconductivity. Research is carried out at INEL, Ames, ANL, LANL, LBL, LLNL, ORNL, PNL, Sandia, SERI, and universities.

There are five budget areas under the Metallurgy and Ceramics category: structure of materials, mechanical properties, physical properties, radiation effects and engineering materials.

The structure of materials area supports research designed to enhance our understanding of the atomic, electronic, defect and microstructure of materials, how they are affected by chemical composition and processing, and how they relate to material properties.

The budget area of mechanical properties is concerned with material behavior related structural integrity requirements of all energy systems. Research addresses the understanding of strength at high and low temperatures creep, fatigue, elastic constants, micro- and macrostrain, fracture, and mechanical-chemical effects in hostile environments.

Research under the physical properties area is directed toward understanding the fundamental phenomena controlling thermal, optical, mass transport, and electrical properties of materials, how they can be altered by various heat treatments or other processing steps, and how they are affected by external variables such as temperature and pressure.

The radiation effects area encompasses research delineating radiation induced changes of materials properties important to fusion and fission energy concepts. The effect of irradiation, both neutron and ion, on mechanical properties, structure and electrical properties is studied in this area.

In the engineering materials area, research is aimed at understanding more fully the complex materials and phenomena generally associated with real world materials problems. Some of the topics under study include: erosion, friction and wear, engineering corrosion and fracture, welding and joining, non-destructive evaluation, and the forming and processing of materials.

B. Solid State Physics, FY 1981 (\$37.6M) FY 1982 (\$42.3M)

The solid state physics category is directed toward fundamental research on matter in the condensed state, wherein the interactions of electrons, atoms, and defects are tracked with the purpose of determining the critical properties of solids. These interactions are the ultimate source of all materials properties. Research under this category includes a broad spectrum of experimental and theoretical efforts, which contribute basic solid state knowledge important to all energy technologies. Accelerated progress is made in this field through the rapid advancements in unique experimental tools and their coupling with high-speed computer systems. Through these efforts, fundamental understanding of matter in the condensed state contributes broadly to characterizing material properties and processes important for all energy technologies. Research is carried out at Ames, ANL, BNL, LANL, LBL, LLNL, ORNL, PNL, Sandia, and universities.

There are five budget areas within the solid state physics category: neutron scattering, experimental research, theoretical research, particle-solid interactions, and engineering physics.

The neutron scattering area supports research of a unique kind, namely the use of the neutron as an analytical probe of the properties of solids and liquids. With this probe, fundamental parameters of superconductors, magnets, hydrides, and solid imperfections are determined in a manner that cannot be accomplished by any other technique. The exploitation of this probe is being advanced by recent development of more efficient monochromators and wider use of longer wavelength probes. Increased efforts are conducted with neutrons from pulsed spallation sources at ANL and LANL. The bulk of the Nation's efforts in this important area has historically been supported at DOE laboratories, where the advanced research reactors are in operation.

The experimental research area is very broad and includes all fundamental investigations, experimental in concept, on liquids and solids of metals, alloys, semiconductors, insulators, and compounds. The area of high-temperature energy systems is being pursued. Ion implantation and backscattering research is being used to learn how to improve superconductor and photovoltaic performance. Hydrogen and hydrides are under study through ultrahigh-pressure and spectroscopic techniques. Synchrotron radiation is utilized in characterizing surfaces with particular relation to catalytic response.

With nearly all these experimental areas, a highly advanced theoretical research program is closely coupled. A large part of the theoretical effort is directed towards dynamic processes in solids and liquids and requires extensive use of DOE's most advanced computer complexes.

Under particle-solid interactions, a major effort is under way to correlate the complex effects of particles of different mass, energy, and charge not only on surfaces but in bulk materials as well.

The engineering physics area supports research to fulfill the much needed goal of utilizing solid state physics expertise in engineering research for which it has a unique capability. Typical of the work initiated are research laboratory investigations of novel processing techniques with mass spectrometer-computer control for complex material preparation, such as solar materials and superconducting alloys. Another area is the extension of cryogenic and refrigeration techniques to new fluid systems that hold promise for the utilization of low-grade heat.

C. Materials Chemistry FY 1981 (\$11.4M) FY 1982 (\$11.7M)

The materials chemistry category provides support for research directed toward developing our understanding of the chemical properties of materials as determined by their composition, structure, and environment (pressure, temperature, etc.) and to show how the laws of chemistry may be used to understand physical as well as chemical properties and phenomena. Included, for example, are studies of energy changes accompanying transformations, the influence of varying physical conditions on rates of transformations, and the manner in which the structure of atomic groupings influences both properties and reactivity.

Chemical concepts coupled with physical experimental techniques are used to study the kinetics of reactions of solids and liquids, the interaction and/or penetration of species in adjacent media, corrosion phenomena and the stability of high-temperature materials of interest to fossil and geothermal technologies. The program also includes research on the chemical thermodynamics of fission products and their interactions with fuels and cladding materials. Electrochemistry is an important aspect of research supported under this category. Research involving elastomers and polymers is also being pursued. Research is carried out at Ames, ANL, LANL, LBL, LLNL, ORNL, and universities.

There are three budget areas in the materials chemistry category: structural chemistry, engineering chemistry, and high-temperature and surface chemistry.

Structural chemistry involves studies of a wide variety of problems where a knowledge of the relationship between the atomic structures of materials and their reactivity is required. Important examples of these effects include the influence of different chemical environments on the catalytic properties of metals. Changes in both the crystal and magnetic structures of compounds are correlated with their specific roles in fuel synthesis, for example.

The methods of engineering chemistry are applied to problems that are currently limiting the efficiency of energy conversion systems. Examples of research underway include: structural and morphological changes that arise during the charge-discharge cycles of the high-temperature battery and studies of thermodynamics of advanced nuclear fuels.

The high temperature and surface chemistry area includes programs on fundamental studies of the influence of surface properties on reactivity. The correlation of mass transport and thermodynamic properties of molten salts in high-temperature battery systems and chemical studies of the influence of micro-inclusions such as sulfides on the formation of pits and crevices to determine whether these inclusions play a significant role in the initiation of stress-corrosion cracking are examples of research underway.

Appendix L: Division of Advanced Energy Conversion

SiC Impregnation of Diesel Engine Components

DOE Contact: J. W. Fairbanks, (301) 353-2822, FTS 233-2822
Division of Advanced Conversion Technology

DOE/PNL Contract: B-B0193, Laystall Engineering Ltd. Wolverhampton, UK -
J.E. Tanner, (011) 44-902-51789
B-B0195, Transamerica/Delaval, Oakland, CA -
A.R. Fleisher, (415) 577-7400
FY 82 Funds: \$52.3 K

Investigate the potential increased erosion resistance of diesel engine cylinder liners and piston rings impregnated with SiC particles by Laystall Engineering. Components to be engine tested by Transamerica/Delaval using oil-water emulsions and/or heavy petroleum fuels.

Controlled Nucleation Thermochemical Deposition of SiC on Thermal Barrier Coatings

DOE Contact: J.W. Fairbanks, (301) 353-2822, FTS 233-2822
San Fernando Laboratories, Pacoima, CA -
J.J. Stiglich, (213) 899-7484

DOE/PNL Contract: FY 81: B-A0759 (\$96.4 K)
FY 82: B-B0198 (\$82.5 K)

SiC overlayers have the potential to (1) act as sealing layers to prevent penetration of condensates from dirty combustion environments into ceramic coatings and (2) provide erosion resistance to the underlying thermal barrier coating.

The FY 81 program will evaluate the potential of the Controlled Nucleation Thermochemical Deposition (CNTD) process developed at San Fernando Laboratory for producing SiC overlayers on segmented or porous thermal barrier coatings.

Based on the results of the FY 81 work, piston caps and valve inserts with thermal barrier coatings will be SiC overcoated for diesel engine testing in FY 82.

In a separate task, a tungsten/tungsten carbide coating will be applied to fuel injector components of a diesel engine. The resistance of the coated injector to wear by coal derived liquids and/or coal-slurries will be measured.

Insulative/Wear Resistance Materials for the Adiabatic Diesel Engine

DOE Contact: J.W. Fairbanks, (301) 353-2822, FTS 233-2822

DOE/PNL Contract: FY 82: B-D8533 (\$90 K)
Cummins Engine Company, Columbus, IN -
Roy Kamo, (812) 379-5591

Investigate the use of ZrO_2 densified with Cr or other oxides for application in the adiabatic diesel engine. This class of materials has the potential for providing erosion/corrosion resistance to engines operated on alternate fuels. Cylinder liners, heads, ports, and piston crowns will be fabricated from the densified ZrO_2 and will be engine tested.

Electron Beam Reactive Physical Vapor Deposition of Thermal Barrier Coatings

DOE Contact: J.W. Fairbanks, (301) 353-2822, FTS 233-2822
Airco-Temescal, Berkeley, CA - E.R. Demeray,
(415) 841-5720, Ext 380

DOE/PNL Contract: FY 81: B-A0760, B-B0449, (\$131 K)
FY 82: B-B0199 (\$125 K)

This program is divided into two tasks:

- (1) Develop a computer controlled EB-PVD coater to provide highly reproducible coating parameters over a wide dynamic range of deposition conditions. Twenty-one (21) samples submitted for testing at NASA-Lewis.
- (2) Systematically investigate the variables affecting the adherence of substoichiometric thermal barrier layers on α -alumina forming metallic coatings. Samples will be sent to NASA-Lewis for thermal cyclic testing and to the David Taylor Laboratory, Annapolis, for low temperature hot corrosion testing.

Investigation of the Effect of Alternate Fuels on 2-Stroke Diesel Engine Operation

DOE Contact: J.W. Fairbanks, (301) 353-2822, FTS 233-2822

DOE/PNL Contract: FY 81: B-A0764 (\$15 K)
FY 82: B-B0196 (\$42.6 K)
Norwegian Institute of Technology, Trondheim, Norway -
Arthur Sarsten, (075) 95511

Investigation of methods to improve large industrial/utility medium speed diesel engine efficiency and durability through use of ceramic coatings on combustion zone components. This study shall use data developed on both residual petroleum fuels, shale oil refined to Marine Fuel Diesel and SRC-II middle distillate coal-derived liquid fuel and coal slurries, with emphasis on the latter. The erosion of the slurries on injectors, pumps, and combustion zone components will also be measured. This program is to provide analysis of advantages and directions to pursue with thermally insulated combustion zone components (the adiabatic concept) coupled with Norwegian thermal insulating coating experience, digitally controlled fuel injection, and computer models.

Investigate Vanadium and Hot-Corrosion Resistance of Cr-Si Base Coating System

DOE Contact: J.W. Fairbanks, (301) 353-2822, FTS 233-2822
Pratt and Whitney, West Palm Beach, FL - R.H. Barkalow

DOE/PNL Contract: B-A0766
FY 81: \$80.0 K
FY 82: \$50.4 K

Develop an improved metallic coating using the silicon base system for industrial/utility gas turbine hot-sections operating on high vanadium sulfur and sodium base petroleum fuels, minimally processed coal-derived fuels, and petroleum/shale oil fuels. This program will also provide a reduced use of strategic materials.

Development of Advanced Plasma Sprayed Ceramic Coatings for Industrial Gas Turbines

DOE Contact: J.W. Fairbanks, (301) 353-2822, FTS 233-2822
Pratt and Whitney, East Hartford, CT -
D.S. Duvall, (203) 565-7775

DOE/PNL Contract: B-A0747
FY 81: \$138 K
FY 82: \$ 69 K

Develop durable ceramic coatings for near-term industrial/utility gas turbine hot-section components, primarily airfoils, to substantially improve hot-corrosion/erosion resistance and achieve advantages of thermal insulation.

Thermal stress resistance shall be achieved with the plasma spray deposited ceramic coatings by reducing the coatings susceptibility to thermal stain induced spalling during engine operation. The increased spalling resistance is achieved by use of ceramic compositions and process techniques which produce microcrack "toughening" and/or segmentation of the ceramic layer. Early cooled metal bars have gone 10,000 cycles in 1805°F without spallation. These samples lasted 4000 cycles at 1950°F and are currently being tested at 2050°F and have gone 7000 - 13,000 cycles before spallation occurs.

Materials Characterization and Test Co-ordination for Combustion Zone Durability Program

DOE Contact: J.W. Fairbanks, (301) 353-2822, FTS 233-2822
Lawrence Berkeley Laboratory, University of California,
Berkeley, CA - D.H. Boone, (415) 486-4914

DOE/PNL Contract: FY 81: B-B0189 (\$46 K)
FY 82: B-B0197 (\$150 K)

Analyze samples produced in laboratory furnace/crucible tests and samples obtained from supporting combustion test programs (burner rig, engine, etc.) to determine materials degradation mechanisms for selected combinations of combustion parameters, fuel chemistry, and test material (chemistry and structure) in an attempt to build a sound base for predicting combustion zone durability of a wide range of materials exposed at anticipated advanced alternate fuels.

Modified Diesel Engine Combustion Systems for Coal Derived Liquid Fuel Operation

DOE Contact: J.W. Fairbanks, (301) 353-2822, FTS 233-2822

DOE/PNL Contract: FY 81: B-A0763 (\$73 K)
Cummins Engine Company, Columbus, OH -
Roy Kamo (812) 379-5591

Two different combustion techniques (the spark assisted diesel and the pre-combustion chamber) will be investigated for medium speed diesel engines operating on coal-derived liquid fuel.

Advanced Physical Vapor Deposited Ceramic Coatings for Industrial Gas Turbines

DOE Contact: J.W. Fairbanks, (301) 353-2822, FTS 233-2822

DOE/PNL Contract: B-A0762
FY 81: \$63.6 K
FY 82: \$150.0 K
Pratt and Whitney, East Hartford, CT - D.S. Duvall

Ceramic coatings produced by electron-beam physical vapor deposition at Pratt and Whitney have exhibited 20 times greater resistance to thermal cycling induced spalling than the best plasma sprayed ceramic coatings being developed for turbine airfoils. However, it has not been possible to consistently achieve these large improvements due to apparent problems in reproducibly creating the proper ceramic structure. This program will identify the optimum process and ceramic structure characteristics which will allow fabrication of EB-PVD ceramic coatings with reproducibly good spall resistance.

Development and Engine Testing of Ceramic Coatings on Diesel Engine Components

DOE Contact: J.W. Fairbanks, (301) 353-2822, FTS 233-2822
Central Institute for Industrial Research, Oslo, Norway -
Ingard Kvernes, (011) 472-6955880

DOE/PNL Contract: FY 81: B-B0190 (\$25 K)

The objective of this work is to develop ceramic coatings for heat loaded diesel engine components. The diesel engine components are primarily exhaust valves, but include also piston crowns, piston grooves, cylinder liners, and cylinder covers. This program consists of two tasks: (1) test and evaluate ceramic or thermal barrier coatings developed and tested in Norwegian diesel propelled ships operated on residual petroleum fuels, and (2) provide U.S. coatings for Norwegian lab test and evaluation.

Diesel Engine Applications of Glass Matrix Composites

DOE Contact: J.W. Fairbanks, (301) 353-2822, FTS 233-2822

DOE/PNL Contract: FY 82: B-B0194 (\$101.4 K)
United Technologies Research Center, East Hartford, CT -
K.M. Prewo, (203) 727-7237

Investigate the feasibility of using fiber reinforced glass matrix composites for cylinder liners and combustion chamber components of diesel engines operated on CDLF and/or coal slurries. In addition to the possible increased erosion resistance these composites could provide, they may also provide greater stress distribution than traditional monolithic ceramic components or ceramic coatings used in the adiabatic diesel engine.

Combustion Zone Durability Program

DOE Contact: J.W. Fairbanks, (301) 353-2822, FTS 233-2822
Battelle Pacific Northwest Laboratory, Richland, WA -
D.D. Hays, (509) 373-2829, FTS 440-2829 (Program
Management)
J.T. Prater, (509) 373-3012, FTS 440-3012 (Research
Programs)

Contract: PNL-001-001 FY 81: \$1066 K Total Program Funds
PNL-002-001 FY 82: \$1300 K Total Program Funds

The objective of the Combustion Zone Durability Program is to identify potential factors limiting materials durability in combustion zone hot components of heat engines operated on advanced alternate fuels and to develop materials and materials system (coatings/substrates) to assure durable operation with these fuels with minimum modifications to existing equipment designs.

PNL manages the Combustion Zone Durability Program using industrial, academic, and other government laboratories to address critical materials problems that are likely to restrict usage of alternate fuels in optionally fuel heat engines. Program definition, priority assignment, and program reviews are supported by a Steering Committee composed of individuals with proven expertise in coating development from inception through the engine use who are now working in National Labs or other government agencies.

PNL manages the CZD program as well as conducting in-house research programs in support of it. Program costs at PNL (including program management, steering panel expenses, and in-house research) were:

FY 81: \$218 K
FY 82: \$320 K

In-house research programs include:

1. The development and use of high rate triode sputtering techniques. Triode sputtering provides much greater flexibility for variation and control of coating composition and structure. Both high rate triode d.c. and r.f. sputtering shall be used to deposit hybrid coatings of MCrAlY with stabilized ZrO_2 or Al_2O_3 that are adherent to metal substrates and impermeable to combustion product condensates. The durability of graded metal to ceramic layers will be evaluated with respect to the selection, distribution, and coarsening of metal and ceramic phases. Coatings with dense outer layers of pure ceramic and mixed metal-ceramic outer layers will be prepared for hot corrosion and erosion testing.
2. The development and use of plasma spraying for the application of erosion resistant/insulative coatings. Coatings with SiC particles and fibers incorporated in metallic and ceramic matrices are being prepared.
3. Independent examination and test facilities to support DOE funded programs. This includes providing burner rig testing of ceramic and metallic coatings with doped petroleum fuels or coal-derived liquids.

Applications of Composite Gas Turbine Components \$300 K

DOE Contract: J.W. Fairbanks, (301) 353-2816, FTS 233-2816
General Electric Gas Turbine Division, Schenectady, New York
(Contract No. DE-AC01-80ET17005) - Gene Kunkel, (518) 383-7206

Objectives: Maximize the potential for durability, reliability, and performance of large gas turbine hot-stage parts by evaluating a hybrid bucket composed of airfoil vanes of optimized creep.

rupture and low cycle fatigue properties, dovetails of high tensile strength and ductility; and corrosion resistant overlays.

Status: The technology development evaluates a hybrid bucket composed of a directionally solidified airfoil section, which is diffusion bonded using hot isostatic pressing to a dovetail section of powdered metal.

Three directionally solidified airfoil alloys (MAR-M200+Hf, Rene-80H and 441) and two powdered metal alloys (AP-1 and PA-101) are being evaluated with primary emphasis on assessing bondline strength, heat treat effects, stress rupture, low cycle fatigue and tensile strength, over a range of operating temperatures.

The results to date indicate the possibility of a significant increase in allowable bucket metal temperatures leading to increased gas turbine output and/or efficiency. Low cycle fatigue tests of DS airfoil specimens demonstrate significant improvements over conventional cast alloys, ranging 10x to 80x. Similarly, the tensile tests of PM dovetail specimens demonstrate significant improvements in strength and ductility over conventionally cast alloys, ranging 20% to 200% respectively.

Keywords: Directionally Solidified, Consolidated Powers, Materials Characterization

Appendix M: Office of Technical Coordination
(Advanced Research and Technology Development)

The objectives of the Advanced Research and Technology Development program are to assess and identify long-range advanced research needs in coal processing, fossil fuels utilization and extraction, materials, components, and instrumentation; to provide oversight of ongoing advanced research in fossil energy so as to ensure balance and proper priorities; to initiate and fund projects involving new, exploratory concepts or goal-oriented basic research; to manage the Materials Research and University Coal Research programs; and to provide policies for, and overview of, Fossil Energy-supported university activities. The Advanced Research and Technology Development program also is designed to provide an effective communications channel between the Fossil Energy program and academic institutions; to encourage these institutions to become involved in programs related to the DOE Fossil Energy mission; and to manage programs concerned with providing an adequate technical base for development of commercial construction materials and instrumentation for Fossil Energy pilot plants and demonstration plants.

It should be noted that a few contracts that were sponsored by this Office and active in FY 1981 and FY 1982 were negotiated and funded from prior years' appropriations. In this context, the exact funding level for these activities are not easily determined, and thus are indicated in the text as PYA, prior years' appropriation.

1. <u>Management of the AR&TD Fossil Energy</u>	FY 1981 \$225 K
<u>Materials Program</u>	FY 1982 \$300 K

DOE Contact: S.J. Dapkunas, (301) 353-2784, FTS 233-2784
Oak Ridge National Laboratory (Contract No. W-7405-eng-26)
R.A. Bradley, P.T. Carlson, (615) 574-6094, FTS 624-6094

The overall objective of the Advanced Research and Technology Development (AR&TD) Fossil Energy Materials Program is to conduct a fundamental long-range research and development program that addresses, in a generic way, the materials needs of fossil energy systems and ensures the development of advanced materials and processing techniques. The purpose of this task is to manage the AR&TD Fossil Energy Materials Program in accordance with procedures described in the Program Management Plan approved by DOE.

This task is responsible for preparing the technical program plan; preparing budget proposals for the Program; assigning work to be accomplished by sub-contractors and by ORNL; placing and managing subcontracts for fossil energy materials development at industrial research centers, universities, and other government laboratories; and for reporting the progress of the Program.

Keywords: Management; Materials Program

2. Critical Materials Requirements for Synthetic Fuel Facilities FY 1981 \$50 K
FY 1982 \$42 K

DOE Contact: S.J. Dapkunas, (301) 353-2784, FTS 233-2784
Oak Ridge National Laboratory (Contract No. W-7405-eng-26)
D.L. Lennon, (615) 574-9535, FTS 624-9535

The purpose of this task is to identify and quantify the critical materials requirements for designated synthetic fuel facilities. The initial effort is directed to a generic direct coal liquefaction facility. The basic approach is similar for all materials and energy facilities investigated. It is performed as an engineering estimate of material requirements based on engineering and technical data for the type of synthetic fuel facility being investigated and is supplemented with commodity/economic data where the latter approach is more effective (such as in indirect materials requirements). This method may be characterized as a microanalysis approach (i.e., building the whole from its parts), as opposed to the macroanalysis approach using national economic input/output data that forms the basis of some investigations reported in the literature to date.

Keywords: Critical Materials; Synthetic Fuel Facilities

3. Technical Monitoring of Coal Gasification Subcontracted Materials Projects for the AR&TD Fossil Energy Materials Program FY 1981 0
FY 1982 \$50 K

DOE Contact: S.J. Dapkunas, (301) 353-2784, FTS 233-2784
Argonne National Laboratory (Contract No. W-31-109-eng-38)
W.A. Ellingson, (312) 972-5068, FTS 972-5068

The purpose of this technical management activity is to assist DOE Headquarters, DOE Oak Ridge Operations, and Oak Ridge National Laboratory with technical monitoring of the subcontracts of the AR&TD Fossil Energy Materials Program which are related to high-temperature gaseous corrosion, corrosion of refractories and ceramics, and nondestructive evaluation methods.

Keywords: Technical Monitoring; Coal Gasification

4. Microstructural Effects in Abrasive Wear FY 1981 \$15 K
FY 1982 0

DOE Contact: S.J. Dapkunas, (301) 353-2784, FTS 233-2784
University of Notre Dame, Department of Metallurgical Engineering and
Materials Science (Contract No. DE-AS05-77ET10460, A004)
T.H. Kosel, N.F. Fiore, (219) 283-4516

This research was aimed at establishing quantitative relations between micro-

structure and wear resistance for highly alloyed white irons and cobalt-base powder metallurgy alloys that are commonly used in coal mining, handling, and conversion processes. The project involved mechanical testing, metallographic analysis, and wear testing. The mechanical testing was to establish the correlation between wear and other mechanical behavior such as plastic deformation. The metallographic analysis was to establish quantitative relationships between wear mechanisms and microstructural parameters. The wear testing included characterization of wear scars produced in laboratory systems by computer-aided microtopographical examination, scanning, and transmission electron microscopy, and quantitative microanalysis of phases. This project was completed in FY 1981.

Keywords: Abrasion; Wear; Materials Characterization

5. <u>Wear-Resistant Alloys for Coal Handling</u>	FY 1981	PYA
<u>Equipment</u>	FY 1982	0

DOE Contact: S.J. Dapkunas, (301) 353-2784, FTS 233-2784
University of California, Department of Materials Science and
Mineral Engineering (Contract No. DE-AS05-79ET10698, A002)
V.F. Zackay, E.R. Parker, (415) 642-3811

The goal of this project is the development of wear-resistant alloys for coal transportation and fragmentation equipment. The project involves the establishment of alloy design criteria, the development of evaluation tests, development and characterization of alloy steels of greater hardness and toughness, and the production and evaluation of components through laboratory and in-service tests.

Keywords: Abrasion; Wear; Materials Characterization

6. <u>Alloy Evaluations for Fossil Fuel Process</u>	FY 1981	\$65 K
<u>Plants (Liquefaction)</u>	FY 1982	0

DOE Contact: S.J. Dapkunas, (301) 353-2784, FTS 233-2784
Ames Laboratory (Contract No. W-7405-eng-82)
T.E. Scott, (515) 294-4446, FTS 865-4446

Since petroleum refinery pressure vessels are constructed of 2 1/4 Cr-1 Mo steel (A387-74A-Gr.22-C1.2) with a stainless steel weld overlay liner, it is anticipated that coal liquefaction "dissolver" vessels will be fabricated similarly. In the event the stainless steel liner is breached, the ferritic 2-1/4 Cr-1 Mo steel shell will be exposed to the coal liquefaction environment. Consequently, the objective of this investigation is to evaluate the mechanical property integrity of dissolver vessel materials.

Keywords: Corrosion; Materials Characterization

7. A New Class of Steels for Thick Wall Pressure Vessels

FY 1981 PYA
FY 1982 \$325

DOE Contact: S.J. Dapkunas, (301) 353-2784 FTS 233-2784
University of California, Department of Materials Science
(Contract No. W-7405-eng-26, Union Carbide Corporation Subcontract No. 7843)
E.R. Parker, P.N. Spencer, J.A. Todd, (415) 642-0863

The objective of this work is to develop a new class of pressure vessel steels. Precipitation-hardened alloys should in principle have properties much less sensitive to section thickness than conventional bainitic or martensitic steels. Ni-V-C steels appear capable of giving good mechanical properties with very slow cooling rates. The program will optimize compositions with respect to toughness, weldability, and other operationally important characteristics.

Keywords: Alloy Development; Coatings and Films

8. Alloy Development for Thick Walled Pressure Vessels

FY 1981 PYA
FY 1982 0

DOE Contact: S.J. Dapkunas, (301) 353-2784, FTS 233-2784
University of California, Department of Materials Science
(Contract No. W-7405-eng-26, Union Carbide Corporation Subcontract No. 7843)
E.R. Parker, R.O. Ritchie, J.A. Todd, (415) 642-0863

The current objectives are primarily aimed at producing a modification of 2-1/4 Cr-1 Mo steel (Ni and mischmetal additions) to improve hardenability, toughness, and resistance to temper embrittlement. Good progress has been made in this direction but there has not been a great deal of industrial interest in the compositions currently being examined. Rather, concerns with respect to reaction vessel materials has produced interest in higher chromium materials that have good strength. Alternatively, 2 1/4 Cr-1 Mo steel could remain of interest providing that stable microstructures can be developed that are strong, tough, and resistant to hydrogen attack. The UCB Project will lead the AR&TD effort to produce a modified alloy that can be used in reaction pressure vessels at temperatures as high as 540°C. Alloys that have been produced and characterized through the UCB Program on design of low alloy steels will be examined in some detail to evaluate their adequacy with respect to strength, toughness, and resistance to hydrogen attack under dynamic loading.

Keywords: Alloy Development; Alternative Materials

9. Microstructure and Micro-mechanical Response in Austenitic Stainless Steel Overlays on Low Alloy Steel Plate

FY 1981 0
FY 1982 \$48 K

DOE Contact: S.J. Dapkunas, (301) 353-2784, FTS 233-2784
University of Cincinnati, Department of Materials Science and Metallurgical
Engineering (Contract No. W-7405-eng-26, Union Carbide Corporation
Subcontract No. 19X-22279C)
J. Moteff, (513) 475-3096

This research is expected to provide sufficient information to establish correlations between the weld overlay process, postweld heat treatment, microstructure, micro-mechanical response and macroscopic mechanical behavior. Microhardness is being used to establish the material micro-mechanical behavior at various temperatures. This project will, in addition to furnishing an understanding of the reasons for existing weldment microcracking problems, help optimize the welding process and postweld heat treatment variables.

Keywords: Materials Processing; Materials Characterization

- | | | |
|---|---------|--------|
| 10. <u>Metallurgical Response and Behavior of the</u> | FY 1981 | 0 |
| <u>Weld Fusion and Heat Affected Zone in Cr-Mo</u> | FY 1982 | \$58 K |
| <u>Steels for Fossil Energy Applications</u> | | |

DOE Contact: S.J. Dapkunas, (301) 353-2784, FTS 233-2784
University of Tennessee, Department of Chemical, Metallurgical, and Polymer
Engineering (Contract No. W-7405-eng-26, Union Carbide Corporation Sub-
contract No. 7685X77)
C.D. Lundin, (615) 974-5170

The objective of this research is to develop fundamental information on the metallurgical behavior of the heat affected zone of welds in chromium-molybdenum alloys. This is being accomplished by: (1) documenting transformation behavior under the welding conditions that involve rapid heating and cooling, (2) determining the metallurgical transformation products in the heat affected zone and fusion zone, (3) determining the sensitivity of the materials to heat affected zone cracking, (4) determining the sensitivity of the materials to phenomena such as reheat cracking and/or hot cracking, and (5) determining the influence of the various heat affected zone regions on the creep rupture behavior.

Keywords: Materials Processing; Materials Characterization

- | | | |
|--|---------|--------|
| 11. <u>Characterizing and Improving the Toughness of</u> | FY 1981 | \$80 K |
| <u>Thick-Sectioned Electroslag Weldments</u> | FY 1982 | \$92 K |

DOE Contact: S.J. Dapkunas, (301) 353-2784, FTS 233-2784
Colorado School of Mines, Department of Metallurgical Engineering
(Contract No. W-7405-eng-26, Union Carbide Corporation
Subcontract No. 19X-07219C)
G.R. Edwards, R.H. Frost, (303) 273-3773

The objective of this program is to characterize the effects of process variables, including potential, electrode composition and velocity, and flux composition, that are important to the optimization of the electroslag welding process. Early work focused on electroslag weldments in 100 mm plates of 2-1/4 Cr-1 Mo steel. Emphasis was placed on process control and flux development rather than microstructural and mechanical properties characterization. Welding of thicker plates is not envisioned since to some extent commercially produced electroslag weldments in 2 1/4 Cr-1 Mo steel are currently available. In contrast, the CSM Program is aimed at a more fundamental understanding of the electroslag welding process.

Keywords: Materials Processing; Joining Methods; Materials Characterization

12. Characterization of Heavy Section Weldments FY 1981 \$90 K
of 2-1/4 Cr-1 Mo Steel FY 1982 0

DOE Contact: S.J. Dapkunas, (301) 353-2784, FTS 233-2784
Oak Ridge National Laboratory (Contract No. W-7405-eng-26)
G.M. Goodwin, D. P. Edmonds - (615)574-4809, FTS 624-4809

Submerged-arc, electron-beam, and narrow gap gas tungsten arc weldments were characterized under this program. Characterization included microstructural analyses, mechanical properties testing, and investigations of postweld heat treatment time and temperature effects on toughness and strength.

Keywords: Materials Processing; Material Characterization

13. An X-Ray Study of Residual Stresses in FY 1981 \$104 K
Narrow Groove TIG Weldments FY 1982 0

DOE Contact: S.J. Dapkunas, (301) 353-2784, FTS 233-2784
Pennsylvania State University Materials Research Laboratory
(Contract No. DE-AC05-79OR13591)
C.O. Ruud - (814) 863-2843

X-ray diffraction techniques are being used to measure residual stresses adjacent to welds of various types. The first activity is an X-ray stress analysis of the NG-GTA weld produced by Westinghouse-Tampa. This will be followed by a detailed analysis of a SAW weld and a NG-GTA weld in the 300 mm plate of 2 1/4 Cr-1 Mo steel obtained by ORNL. Efforts will be made to procure and analyze an electron beam (EB) weldment in the same plate. An examination of residual stress distribution in cladding will be made. Experimental data obtained on weldments will be correlated with predictions based on a finite element model, experimental mechanical properties data produced elsewhere in the AR&TD Program.

Keywords: Materials Processing; Materials Characterization

14. Development of Automated Welding Processes FY 1981 \$277 K
of 2-1/4 Cr-1 Mo Steel FY 1982 0

DOE Contact: S.J. Dapkunas, (301) 353-2784, FTS 233-2784
Westinghouse Electric Corporation, Tampa Division
(Contract No. DE-AC05-78OR13511)
U. A. Schneider - (904) 477-0535

A variation of the gas tungsten-arc welding process was investigated. This process uses AC-heated filler wire and a narrow joint preparation to increase the rate at which filler metal is deposited and reduce the amount of filler necessary for a given application. Welding characteristics of the system and properties of the weld were investigated. A field demonstration of the process, including all necessary fixturing and positioning equipment, was made after laboratory research was completed.

Keyword: Materials Processing

15. Hydrogen Attack in Cr-Mo Steels at Elevated FY 1981 \$129 K
Temperatures FY 1982 \$152 K

DOE Contact: S.J. Dapkunas, (301) 353-2784, FTS 233-2784
Cornell University, Materials Science and Engineering Department
(Contract No. W-7405-eng-26, Union Carbide Corporation
Subcontract No. 7963)
Che-Yu Li - (607) 256-4349

The objective of this program is to determine the kinetics of nucleation and growth of methane bubbles or cavities in 2 1/4 Cr-1 Mo steels (primarily ASTM 387) at elevated temperatures under the influence of high pressure hydrogen and applied stress and to develop kinetic equations for estimating the number density and size distribution of grain boundary cavities as a function of time under conditions of interest to coal conversion plant operations. Currently, this is the only in-situ hydrogen attack work supported by the AR&TD Program. All other programs that address hydrogen attack involve autoclave exposure followed by some sort of evaluation. The work on the effect of constant stress and pressure on the nucleation and growth of methane bubbles in low alloy steels will be continued. Models will be developed, based on experimental observations, to describe hydrogen attack in 2 1/4 Cr-1 Mo steel and the important metallurgical parameters will be identified. Work on 3 Cr-1 Mo steel along with tests on a Japanese version of modified 2 1/4 Cr-1 Mo steel will be performed.

Keyword: Hydrogen Effects

16. Evaluation of Fracture Toughness of FY 1981 \$185 K
Pressure Vessel Steels FY 1982 0

DOE Contact: S.J. Dapkunas, (301) 353-2784, FTS 233-2784
Oak Ridge National Laboratory (Contract No. W-7405-eng-26)
R. K. Nanstad - (615) 574-4471, FTS 624-4471

The goal of this task is the characterization of the fracture toughness of steels and their weldments that are candidates for the construction of large coal conversion pressure vessels. Included in this study is the influence of service environment on the stability of mechanical properties.

Keyword: Materials Characterization

17. Effect of Heat Treatment on Microstructure and Mechanical Properties of Modified Low Alloy Steels FY 1981 0
FY 1982 \$200 K

DOE Contact: S.J. Dapkunas, (301) 353-2784, FTS 233-2784
Oak Ridge National Laboratory (Contract No. W-7405-eng-26)
R. K. Nanstad, R. W. Swindeman - (615) 574-4471, FTS 624-4471

The objective of this research is to determine the effects of heat treatment on the microstructure and mechanical properties of modified low-alloy steels and their weldments that are candidates for the construction of large coal conversion pressure vessels. The Cr-Mo steels, including modifications to standard 2-1/4 Cr-1 Mo and 3 Cr-1 Mo specifications, are under development to increase strength at elevated temperatures. This work is concerned with the influence of processing heat treatments, postweld heat treatments, and in-service thermal aging of the microstructures of these modified alloys.

Keyword: Materials Characterization

18. Analysis of Hydrogen Attack on Pressure Vessel Steels FY 1981 \$146 K
FY 1982 \$105 K

DOE Contact: S.J. Dapkunas, (301) 353-2784, FTS 233-2784
University of California at Santa Barbara, Department of Chemical and Nuclear Engineering (Contract No. W-7405-eng-26, Union Carbide Corporation Subcontract No. 19X-22276C)
G. R. Odette - (805) 961-3525

The initial objectives of the program have been achieved and physical models have been developed that describe the initiation and development of methane damage in carbon steel and 2-1/4 Cr-1 Mo steel. Nelson diagrams have been predicted and appear to be reasonably consistent with available data. Additional work is needed to refine the analyses and confirm the adequacy of the basic thermodynamic information available in the literature. The model has been particularly useful in establishing the relative importance of microconstituents, deformation mechanisms, and fracture mechanisms to the hydrogen attack process. In this sense it will guide the development of modified low alloy steels for optimum resistance to hydrogen attack. The role that stress steels

and plastic strain transients play in the hydrogen attack phenomena is being examined. Such information is vital because the current design rules for hydrogen service restrict the use of the Nelson curves to situations where the stresses do not exceed the primary stress intensities provided in the ASME Boiler and Pressure Vessel Code.

Keyword: Hydrogen Effects

19. The Fatigue Behavior of Chromium Containing Ferritic Steels at Elevated Temperature FY 1981 0
FY 1982 \$ 67 K

DOE Contact: S.J. Dapkunas, (301) 353-2784, FTS 233-2784
University of Connecticut, Metallurgy Department
(Contract No. W-7405-eng-26, Union Carbide Corporation
Subcontract No. 19K-22278C)
A. J. McEvily - (203) 486-2941

The objective of this research is to obtain a detailed understanding of the fatigue behavior of these alloys in terms of metallurgical and environmental effects. This understanding should provide a basis for the quantitative analysis of service lifetimes as well as for the optimization of the microstructure for fatigue resistance. Areas of research include fatigue crack initiation and propagation at elevated temperatures in chromium steels and their weldments with particular emphasis on the influence of oxidation.

Keyword: Materials Characterization

20. Deformation and Fracture of Low Alloy Steels at High Temperatures FY 1981 0
FY 1982 \$159 K

DOE Contact: S.J. Dapkunas, (301) 353-2784, FTS 233-2784
University of Illinois, Department of Mechanical and Industrial
Engineering (Contract No. W-7405-eng-26, Union Carbide Corporation
Subcontract No. 19X-22239C)
D. L. Marriott - (217) 222-7237

The objective of this work is to investigate the microstructural changes and the mechanisms of damage accumulation that accompany, or arise from, high temperature deformation of a range of 2-1/4 Cr-1 Mo steels. The tests conducted under this program will provide a description of the microstructural changes in the chosen test materials under steady and cyclic loading. Progress toward understanding mechanisms of damage accumulation in the test materials for a spectrum of loading conditions should also result from this work. The results of the program will also provide a basis for the development of constitutive relations for correlation of damage and failure.

Keyword: Materials Characterization

21. Study to Optimize Cr-Mo Steels to Resist Hydrogen and Temper Embrittlement FY 1981 \$ 81 K
Fy 1981 \$ 90 K

DOE Contact: S.J. Dapkunas, (301) 353-2784, FTS 233-2784
Westinghouse Electric Corporation Research and Development Center
(Contract No. DE-AC05-78OR13513)
B. J. Shaw - (412) 256-3255

This program developed from earlier work sponsored by the American Petroleum Institute and has as its objective the establishment of the effects of composition and strength level on the tendency of Fe-Cr-Mo steels to undergo temper or hydrogen embrittlement (KISCC). Although these correlations will be developed from knowledge of the composition and heat treatment, the resulting model is expected to be largely empirical and lack a sound metallurgical basis. To rectify this situation Westinghouse initiated a new program to fully characterize the microstructures and constituents in the alloys prepared for the embrittlement work. The characterization data will be of considerable value to the hydrogen attack studies.

Keyword: Hydrogen Effects

22. Program on Corrosion of Metals in Coal FY 1981 \$284 K
Liquefaction Processes FY 1982 \$146 K

DOE Contact: S.J. Dapkunas, (301) 353-2784, FTS 233-2784
The Metal Properties Council, Inc. (Contract No. DE-AC05-79OR13546)
Martin Prager, F. F. Lyle, Jr., L. M. Adams - (212) 644-7693

The objectives of this program are to (1) determine the general susceptibility of carbon steels, and nickel-base alloys to corrosion in coal liquids; (2) identify and measure concentrations of suspected corrosive species in coal liquids before and after corrosion tests; (3) determine the effect of temperature on corrosion of metals and on the stability of corrosive species in coal liquids; (4) relate extent, type of corrosion, and corrosion mechanism(s) to corrosive species present in coal liquids; and (5) provide background data for the interpretation of results of in-situ corrosion tests and failures in liquefaction plants.

Keyword: Corrosion

23. Corrosion in Coal Derived Liquids FY 1981 \$350 K
FY 1982 \$450 K

DOE Contact: S.J. Dapkunas, (301) 353-2784, FTS 233-2784
Oak Ridge Laboratory (Contract No. W-7405-eng-26)
J. R. Keiser, R. R. Judkins, V. B. Baylor - (615) 574-4453, FTS 624-4453

The purpose of this research is to study the modes of corrosive attack occurring in coal liquefaction processes. Such corrosion modes include general attack by organic and inorganic acids and stress-corrosion cracking. Basic corrosion studies are conducted to understand the reaction between the oxidants and engineering materials. In addition, this task includes pilot plant testing of alloys for resistance to corrosion and stress-corrosion cracking in various

coal liquefaction process stream environments. The results of this work should provide an understanding of the various corrosion modes observed as on corrosion of metals and on the stability of corrosive species in coal ure liquids; (4) relate extent, type of corrosion, and corrosion mechanism(s) to corrosive species present in coal liquids; and (5) provide background data for the interpretation of results of in-situ corrosion tests and failures in liquefaction plants.

Keyword: Corrosion

24. Evaluation of Advanced Materials for Use
in Coal Liquefaction Letdown Valves

FY 1981 #248 K
FY 1982 \$267 K

DOE Contact: S. J. Dapkunas, (301) 353-2784, FTS 233-2784
Battelle-Columbus Laboratories (Contract No. W-7405-eng-26, Union
Carbide Corporation Subcontract No. 85X-69611C)
I. G. Wright, A. H. Clauer - (614) 424-4377

The original aim of this project was to obtain erosion data on several candidate valve trim materials under a range of slurry erosion conditions that would be useful to valve and process engineers involved in materials selection and valve design. Reconstituted coal-derived slurries were used to erode candidate materials under a range of slurry velocity and impingement angle conditions. Characterization of the erosive slurries, ranking of the erosive resistance of cemented tungsten carbides and various ceramics, and service trails of an experimental carbide valve stem were completed.

The project continues to obtain erosion data on candidate valve trim materials under varied wear conditions, investigate several approaches to the development of new erosion-resistant materials, and characterize the erosion behavior of new materials. In addition, a suitable substitute erodent and liquid carrier combination is being developed for use in standardized laboratory materials evaluation and screening tests, which preferably will reduce levels of health risks and handling problems. This project will help to develop an understanding of materials behavior in slurry erosion.

Keywords: Erosion; Materials Characterization

25. Studies of Materials Erosion in Coal
Conversion Systems

FY 1981 \$160K
FY 1982 \$297K

DOE Contact - S. J. Dapkunas, (301) 353-2784; FTS - 233-2784
Lawrence Berkeley Laboratory (Contract No. W-7405-eng-26, Union
Carbide Corporation Memorandum Purchase Order No. 19X-22247V)
A. V. Levy - (415) 486-5822; FTS - 451-5822

The objective of this program is to determine the erosion-corrosion behavior of materials used in the flow passages of liquid slurries under conditions representative of those in coal liquefaction systems. From the understanding

gained from testing different materials over a range of controlled operating conditions within and beyond those of currently acceptable practice, slurry flow operating parameter criteria will be developed. The information that will be gained from this program will be structured in a manner that will make it directly usable by coal liquefaction system designers.

Keywords: Corrosion; Erosion and Wear

26. Develop Model Alloys with Refractory-Metal Additions and Oxide-Dispersion-Strengthened Alloys FY 1981 0
FY 1982 \$30K

DOE Contact - S. J. Dapkunas, (301) 353-2784; FTS - 233-2784
Argonne National Laboratory (Contract No. W-31-109-eng-38)
W. A. Ellingson, K. Natesan - (312) 972-5068; FTS - 972-5068

This project emphasizes the development of Fe-Cr-Ni alloys with refractory metal (Nb, Zr, etc.) additions and development of Fe-base ODS alloys with cerium oxide and yttrium oxide additions. Detailed evaluation of promising alloys will be continued in subsequent years. Once suitable compositions for corrosion resistance are established, the developed alloys may be used as cladding, coating, or coextruded tubes in gasification systems.

Keywords: Oxide-Dispersion; Alloys

27. Creep Rupture Properties of High-Chromium Alloys in Simulated Coal Gasification Atmospheres (CGA) FY 1981 0
FY 1982 \$80K

DOE Contact - S. J. Dapkunas, (301)353-2784; FTS - 233-2784
Argonne National Laboratory (Contract No. W-31-109-eng-38)
W. A. Ellingston, K. Natesan - (312)972-5068; FTS - 972-5068

The purposes of this project are to (1) experimentally evaluate the uniaxial creep rupture behavior of selected high-chromium alloys (e.g., Incoloy 800H, Type 310 stainless steel) and weldments exposed to complex gas mixtures typical of coal-conversion process environments, and (2) correlate the creep properties such as rupture life, rupture strain, and minimum creep rate with the chemistry of exposure environment, temperature, and alloy chemistry.

Keywords: Creep Rupture; High-Chromium Alloys

28. The Effect of Coal Gasification Atmospheres on Biaxial Creep of Alloys FY 1981 \$135K
FY 1982 \$200K

DOE Contact - S. J. Dapkunas, (301) 353-2784; FTS - 233-2784
EG&G Idaho, Inc., Idaho National Engineering Laboratory
(Contract No. DE-AC07-76ID01570)
G. R. Smolik - (208) 526-8317; FTS - 583-8317

The purpose of this program is to measure the biaxial stress-rupture strength and ductility of type 310 stainless steel, alloy 800H, Haynes alloy 188, and Inconel 657. Test temperatures range from 649 to 982°C, and time of the tests is to 500 h. Data from this continuing program will be used to supplement existing data on these alloys for coal gasification environments because little information exists on the structure of these alloys after exposure to coal gasification environments.

Keywords: Creep; Gasification

29. Evaluate Corrosion Mechanisms for Potential Candidate Materials in Low- and Intermediate-Btu Gasification Atmospheres FY 1981 \$ 60K
FY 1982 \$295K

DOE Contact - S. J. Dapkunas, (301) 353-2784; FTS - 233-2784
Argonne National Laboratory (Contract No. W-31-109-eng-38)
W. A. Ellingson, K. Natesan - (312) 972-5068; FTS - 972-5068

The work being conducted under this project provides a basic understanding of the corrosion behavior of commercial and model alloys after exposure to multicomponent gas mixtures. The information generated also provides a rational basis for the extrapolation of corrosion rates as a function of temperature, alloy composition, and chemistry of the gas environments. The corrosion experiments (conducted by using a thermogravimetric technique in mixed gas atmospheres) on selected commercial high-chromium alloys and on model alloys fabricated with compositional variations will establish the role of different alloying elements on the mechanisms of scale development and on the breakaway phenomena leading to scale failure.

Keywords: Corrosion; Gasification

30. Exposure of Candidate Metals and Refractories in Selected Coal Gasification Pilot Plants FY 1981 \$100K
FY 1982 0

DOE Contact - S. J. Dapkunas, (301) 353-2784; FTS - 233-2784
The Metal Properties Council, Inc. (Contract No. W-7405-eng-26,
Union Carbide Corporation Subcontract No. 40X-40455C)
A. O. Schaefer, R. Yurkewycz - (212) 705-7693

The purpose of this program is to evaluate candidate materials of construction through a field testing program, which consists of coupon exposure tests in almost all of the coal gasification pilot plants. Tests of one, three, and six months duration at plant operating conditions are used. Correlation between these field tests and laboratory research will yield a strong design data base upon which materials selections can be made.

Keywords: Corrosion; Materials Characterization

31. Screening and Study of Behavior of Materials Subjected to Combined Erosion and Corrosion FY 1981 \$200K
FY 1982 \$287K

DOE Contact - S. J. Dapkunas, (301) 353-2784; FTS - 233-2784
The Metal Properties Council, Inc. (Contract No. W-7405-eng-26, Union
Carbide Corporation Subcontract No. 40X-40455C)
A. O. Schaefer, E. J. Vesley - (212) 705-7693

The purpose of this program is to obtain experimental information on the synergistic effects of corrosion and erosion. Complex laboratory experiments are carried out to evaluate the effects of corrosive environments on erosion behavior. These tests are carried out at high temperature (to 900 C) and high pressure (to 0.7 MPa). Particle velocities of 60 m/s in a corrosive environment are studied. The results from this work will establish the critical erosion parameters for increased materials degradation in an erosion-corrosion environment at elevated temperatures.

Keywords: Erosion; Corrosion; Materials Characterization

32. Development of Nondestructive High-Temperature Erosion Monitoring System FY 1981 \$158K
FY 1982 \$140K

DOE Contact - S. J. Dapkunas, (301) 353-2784; FTS - 233-2784
Argonne National Laboratory (Contract No. W-31-109-eng-38)
W. A. Ellingson, K. J. Reimann - (312) 972-5068; FTS - 972-5068

The purpose of this continuing program is to develop reliable real-time on-line high-temperature systems that will measure erosive wear. An active program involving laboratory and field tests over the past six years has developed a first-generation field-implementable system for real-time monitoring of erosive wear. The program involves development of nondestructive testing methods and evaluation of the reliability of the test methods for the measurement of erosive wear.

Keywords: Nondestructive Testing; Erosion

33. Wear-Resistant Materials for Coal Conversion Components FY 1981 \$150K
FY 1982 0

DOE Contact - S. J. Dapkunas, (301) 353-2784; FTS - 233-2784
Albany Research Center Bureau of Mines U.S. Department of the
Interior (Contract No. De-A105-800R206987)
J. E. Kelley, H. W. Leavenworth, Jr. - (503) 967-5896; FTS - 420-5896

The objective of this work is to improve the performance of coal conversion systems by developing and identifying improved wear-resistant materials for valves, nozzles, and other wear-prone components. The need for these improved materials has been amply demonstrated by frequent failures in gasification and liquefaction plants.

34. Failure Analysis of Components in Coal Gasification Systems FY 1981 \$133K
FY 1982 0

DOE Contact - S. J. Dapkunas, (301) 353-2784; FTS - 233-2784
Argonne National Laboratory (Contract No. W-31-109-eng-38)
W. A. Ellingson, D. R. Diercks - (312) 972-5068; FTS - 972-5068

The purpose of this program is to evaluate the performance of coal conversion plant components that have failed in service and to interact with plant personnel to select alternative materials, design options, and process conditions that may improve component performance. This program has resulted in an active materials information exchange between plant operators and laboratory researchers. Analysis of a failure is typically followed by a recommendation to change the material of construction for better component performance, or to modify operating procedures to avoid failure in the future.

Keywords: Failure Analysis

35. Development of an On-Line Acoustic Valve Leak Detection System FY 1981 \$48K
FY 1982 0

DOE Contact - S. J. Dapkunas, (301) 353-2784; FTS - 233-2784
Argonne National Laboratory (Contract No. W-31-109-eng-38)
W. A. Ellingston, C. A. Youngdahl - (312) 972-5068; FTS - 972-5068

The purpose of this program is to develop a nondestructive acoustic system to detect internal leakage past valves for lock-hopper and dry ash letdown service as well as block valves for coal gasification and liquefaction process plants. A passive acoustic system is being developed and initial field tests have been conducted on large (>6-in.) ball valves for lock-hopper service.

Keywords: Acoustic Detection

36. Development of Acoustic Emission Nondestructive Testing to Detect Fracture of Concrete Linings FY 1981 \$48K
FY 1982 0

DOE Contact - S. J. Dapkunas, (301) 353-2784; FTS - 233-2784
Argonne National Laboratory (Contract No., W-31-109-eng-38)
W. A. Ellingson, C. A. Youngdahl - (312) 972-5068; FTS - 972-5068

The purpose of this program is to develop techniques for the application of acoustic emission sensing to detect crack formation (or other mechanical degradation) of thick refractory concrete linings of the type envisioned for full-scale gasification processes.

Keywords: Acoustic Emission

37. Development of Thermal Shock Resistant Refractories FY 1981 0
FY 1982 \$100K

DOE Contact - S. J. Dapkunas, (301) 353-2784; FTS - 233-2784
Argonne National Laboratory (Contract No. W-31-109-eng-38)
W. A. Ellingson, D. R. Diercks - (312) 972-5068; FTS - 972-5068

The purpose of this program is to develop thermal-shock resistant refractories for use in slagging gasifiers. The proposed improvements will be accomplished by the addition of selected secondary phases in the refractory

compositions so that the thermal and microstructural characteristics of the refractories are suitably modified. The basic principles of thermal shock improvement through such secondary phase additions will be established in the laboratory- and engineering-scale experiments.

Keyword: Refractories

38. Improvement of the Mechanical Reliability of Monolithic Refractory Linings for Coal Gasification Process Vessels FY 1981 \$43K
FY 1982 0

DOE Contact - S. J. Dapkunas, (301) 353-2784; FTS - 233-2784
Babcock & Wilcox Company Research and Development Division
(Contract No. "-7405-eng-26, Union Carbide Corporation
Subcontract No. 40X-92353V)

R. A. Potter - (804) 384-5111; FTS - 671-1060

Monolithic refractory designs based on practices in the petrochemical industry have been used in many of the non-slugging coal gasification processes being developed or partially sponsored by the Department of Energy. These linings are easy to install and relatively inexpensive and generally insulate vessel shells more effectively than brick linings. They are very prone to cracking, however, and it is this characteristic that concerns those involved with the operation and overall performance of coal conversion process. It is generally thought that the cracking and associated thermomechanical degradation of monolithic refractory linings is most significantly affected by their performance during the initial dry-out and heat-up. It was the objective of this work to improve the thermomechanical reliability, i.e., reduce or eliminate the cracking, of monolithic refractory linings of coal gasification process vessels operating to 2000^oF during the initial dry-out and heat-up.

Keywords: Corrosion; Ceramics; Glasses; Materials Characterization

39. Creep Behavior of Monolithic Refractory Materials FY 1981 \$82K
FY 1982 \$170K

DOE Contact - S. J. Dapkunas, (301) 353-2784; FTS - 233-2784
Iowa State University, Engineering Research Institute, Department
of Materials Science and Engineering (Contract No. W-7405-eng-26,
Union Carbide Corporation Subcontract No. 7940)

T. D. McGee - (515) 294-9619; FTS - 865-9619

Refractory concretes appear to be prime candidate materials for the linings of dry ash coal gasification pressure vessels. Due to extreme conditions in the gasification process (temperatures to 1200^oC, stresses to 2000 psi, corrosive atmosphere) it is important to have available high-temperature high stress creep data for these materials. Not only is data important but also information on the mechanisms of creep is desirable. This information is needed for ongoing research at other institutions into elimination of cracking in the refractory linings which causes failure.

Keywords: Ceramics; Glasses; Materials Characterization

40. A Model to Predict Thermal Stress and Strain in Refractory Linings or Brick Linings FY 1981 \$36K
FY 1982 \$176K

DOE Contact - S. J. Dapkunas, (301) 353-2784; FTS - 233-2784
Massachusetts Institute of Technology (Contract No. W-7405-eng-26,
Union Carbide Corporation Subcontract No. 7682)
Oral Buyukozturk - (617) 253-7186

The objective of this continuing program is to modify the existing model for prediction of thermal stress and strain in monolithic linings so that it can be used to predict (and improve) the performance of brick linings.

Keywords: Refractory Liners

41. Investigation of CO Disintegration of Refractories in Coal Gasifiers FY 1981 \$53K
FY 1982 \$68K

DOE Contact - S. J. Dapkunas, (301) 353-2784; FTS - 233-2784
Virginia Polytechnic Institute and State University, Department of
Materials Engineering (Contract No. DE-AC01-80ET13702)
J. J. Brown, Jr. - (703) 961-6777

The objectives of this investigation are to determine (1) whether or not Co disintegration is likely to occur in the refractories used in coal gasifiers, and (2) to identify the conditions under which CO disintegration of the refractories can be expected to be a serious problem. It is also a goal of this investigation to develop information that will assist in the identification of refractory deterioration or failure that is caused by CO disintegration.

Keywords: Corrosion; Ceramics; Glasses

42. Corrosion of Refractories in Slagging Gasifiers FY 1981 \$121K
FY 1982 \$235K

DOE Contact - S. J. Dapkunas, (301) 353-2784; FTS - 233-2784
Argonne National Laboratory (Contract No. W-31-109-eng-38)
W. A. Ellingson, S. Greenberg - (312) 972-5068; FTS - 972-5068

The purpose of this program is to investigate the parameters that affect the corrosion of refractories in slagging gasifiers so that lining lifetimes can be optimized through proper choice of refractory materials, coal selection or modification, and/or changes in process variables.

Keywords: Gasifiers; Corrosion

43. Testing and Development of Materials for Catalytic Coal Gasification Process Equipment FY 1981 \$160K
FY 1982 \$80K

DOE Contact - S. J. Dapkunas, (301) 353-2784; FTS - 233-2784
U.S. Department of the Interior Bureau of Mines
(Contract No. DE-A105-82OR20992)
H. Heystek - (205) 758-0491

The objectives of this research are to: (1) determine the effect of catalytic coal gasification (CCG) environments on metal and refractory materials of construction by exposure to CCG reactor conditions in a laboratory simulator and (2) identify the attach mechanisms of CCG environments on metals and refractories so that materials offering improved performance at lower cost can be identified.

Keyword: Corrosion

44. Design, Engineering, and Evaluation of Refractory Liners for Slagging Gasifiers FY 1981 \$1,019K
FY 1982 \$10K

DOE Contact - S. J. Dapkunas, (301) 353-2784; FTS - 233-2784
IIT Research Institute (Contract No. DE-AC05-78OR13410)
S.A. Bortz - (312) 567-4400

The purpose of this program is to determine the rate of wear of refractory lining systems under slagging conditions at sufficient scale and under prototype conditions to permit refractory lifetime determination. A 1.5-m-diam by 8.5-m-high test facility has been constructed, and the integrated checkout and shakedown of the system has been completed.

Keywords: Corrosion; Ceramics

45. Phase Relations Relevant to Coal Slag FY 1981 \$83K
FY 1982 \$150K

DOE Contact - S. J. Dapkunas, (301) 353-2784; FTS - 233-2784
Pennsylvania State University (Contract NO. W-7405-eng-26, Union Carbide Corporation Subcontract No. 9006)
Arnulf Muan - (814) 865-7659

The purpose of this program is to determine the chemical constraints affecting the performance of refractory materials under experimental conditions corresponding to those prevailing in slagging gasifiers.

In particular, this program concentrates on systems containing chromic oxide because refractories containing significant amounts of this component have demonstrated excellent resistance to corrosion. This program interfaces with the ANL and IITRI programs to provide information on chemical stability of reaction products.

Keywords: Corrosion; Ceramics

46. Engineering Evaluation and Review of IIT Research Institute Refractory Test Facility FY 1981 \$41K
FY 1982 \$15K

DOE Contact - S. J. Dapkunas, (301) 353-2784; FTS - 233-2784
Oak Ridge National Laboratory (Contract No. W-7405-eng-26)
R. A. Bradley - (615) 574-6094; FTS - 624-6094

The objectives of this task are to provide project engineering overview services and to perform evaluations and reviews of the IITRI Refractory Test Facility. The aim is to ensure the timely completion of facility construction and subsequent checkout and shakedown of the unit.

Keywords: Corrosion, Ceramics

47. Silicon Carbide Powder Synthesis FY 1981 0
FY 1982 \$50K

DEO Contact - J. S. Dapkunas, (301) 353-2784; FTS - 233-2784
Oak Ridge National Laboratory (Contract No. W-7405-eng-26)
G. C. Wei - (615) 574-5129; FTS - 624-5129

The purpose of this work is to develop processes for synthesis of improved, highly pure, uniformly sinterable powders. The developmental and some selected commercial SiC powders will be characterized and evaluated.

Keywords: Powder Synthesis; Silicon Carbide

48. Short Fiber Reinforced Structural FY 1982 0
FY 1982 \$200K

DEO Contact - S. J. Dapkunas, (301) 353-2784; FTS - 233-2784
Oak Ridge National Laboratory (Contract No. W-7405-eng-26)
F. C. Gac - (505) 667-5126; FTS - 843-5126

The purpose of this study is to investigate the utility of whisker reinforcement technology for producing structural ceramic composites of improved strength and fracture toughness. The program consists of two technical tasks. The first is to optimize an existing Los Alamos whisker growth process to produce alpha-phase silicon nitride ($-Si_3N_4$) whiskers and beta-phase silicon carbide ($-SiC$) whiskers of uniform size, optimum strength, and in quantities suitable for composite use. The second task will involve evaluating the contribution of the whiskers in selected ceramic-matrix composites.

Keywords: Ceramics

49. Ceramic Fabrication and Microstructure Development FY 1981 0
FY 1982 \$200K

DOE Contact - S. J. Dapkunas, (301) 353-2784; FTS - 233-2784
Oak Ridge National Laboratory (Contract No. W-7405-eng-26)
G. C. Wei - (615) 574-5129; FTS - 624-5129

The purpose of this work is to develop improved structural ceramics by developing techniques for fabrication powders into dense monolithic ceramics and ceramic-matrix composites with controlled microstructure. The task includes correlation of the properties of structural ceramics with their microstructure, crystal structure, microchemistry, and fabrication history.

Keywords: Fabrication, Microstructure; Ceramics

50. Mechanical Behavior and Strength of Structural Ceramics FY 1981 \$125K
FY 1982 \$150K

DOE Contact - S. J. Dapkunas, (301) 353-2784; FTS - 233-2784
Oak Ridge National Laboratory (Contract No. W-7405-eng-26)
P. F. Becher - (615) 574-5157; FTS - 624-5157

The purpose of this work is to develop improved structural ceramics by correlating the mechanical properties of structural ceramics with their microstructure, crystal structure, microchemistry, and fabrication history. Changes in such key properties as flexural strength, fracture toughness, and subcritical crack growth as a function of exposure time to combustion products of fossil fuels at high temperatures are also determined. This correlation is accomplished by determining changes in mechanical properties of the structural ceramics after long-term exposures and comparing with properties of as-manufactured specimens. Another purpose is to identify the degradation mechanisms for these materials and to determine the fundamental role of intrinsic and extrinsic defects, impurities, and second phases in limiting the high-temperature performance of structural ceramics in order to aid in the development of new materials or improvements in existing materials for fossil energy components such as heat exchangers and high-temperature gas turbines.

Keywords: Structural Ceramics

51. High Temperature Applications of Structural Ceramics FY 1981 \$260K
FY 1982 \$263K

DOE Contact - S. J. Dapkunas, (301) 353-2784; FTS - 233-2784
National Bureau of Standards, Center for Material Science
(Contract No. DE-A105-800R20679)
S. J. Schneider - (301) 921-2845

The objective of this study is to characterize the high temperature failure mechanisms and factors that influence their operation with an aim toward improving the properties of structural ceramics, especially silicon carbide and silicon nitride based materials, for use in coal conversion applications.

Keywords: Ceramics; Glasses; Material Characterization

52. Corrosion of Alloys in FBC Systems FY 1981 \$132K
FY 1982 \$165K

DOE Contact - S. J. Dapkunas, (301) 353-2784; FTS - 233-2784
Argonne National Laboratory (Contract No. W-31-109-eng-38)
W. A. Ellingson, K. Natesan - (312) 972-5068; FTS - 972-5068

The purposes of this project are to (1) experimentally evaluate the high-temperature corrosion behavior of iron- and nickel-base alloys in gas environments with a wide range of oxygen, sulfur, and carbon potentials, (2) develop corrosion information in the temperature range 400 to 750 C in mixed-gas atmospheres using internally cooled tube specimens of selected commercial materials, (3) evaluate deposit-induced corrosion behavior of heat-exchanger and gas-tubing materials after exposure to multicomponent gas environments, and (4) develop corrosion rate expressions, based upon experimental data, for

long-term extrapolation to component design lives.

Keywords: Corrosion; Fluidized Bed Combustion

53. Materials Testing in an Atmospheric Fluidized Bed Combustor FY 1981 \$72K
FY 1982 0

DOE Contact - S. J. Dapkunas, (301) 353-2784; FTS - 233-2784
General Atomic Company (Union Carbide Corporation
Subcontract No. 41B28916C)
W. S. Rickman - (714) 455-3860

The purpose of this project is to test materials in an operating atmospheric fluidized bed combustor (AFBC) to determine the mechanism of calcium sulfate film formation on cooled and uncooled heat transfer surfaces.

Keywords: Corrosion

54. Investigation of Gas-Metal Reactions in Cyclic Oxidizing and Reducing Atmospheres and the Effect of Sulfate Deposits on Corrosion FY 1981 \$125K
FY 1982 \$200K

DOE Contact - S. J. Dapkunas, (301) 353-2784; FTS - 233-2784
Oak Ridge National Laboratory (Contract No. W-7405-eng-26)
J. H. DeVan, P. J. Ficalora - (615) 574-4451; FTS - 624-4451

The purpose of this task is to determine the corrosion properties of heat exchanger and uncooled internal structural materials under normal and off-normal heating conditions in coal-fired fluidized-bed combustors (FBCs).

The materials are exposed to simulated FBC environments under a variety of well-defined operating conditions in order to systematically evaluate corrosion-erosion mechanisms as they apply to heat exchanger surfaces in coal-fired, limestone-scavenged fluidized beds. This task is intended to guide the selection of materials of construction for utility and industrial AFBCs intended for the mid 1980s.

Keywords: Gas-Metal Reactions; Fluidized-Bed Combustors

55. Hot Corrosivity of Coal Conversion Products on High-Temperature Alloys FY 1981 0
FY 1982 \$90K

DOE Contact - S. J. Dapkunas, (301) 353-2784; FTS - 233-2784
University of Pittsburgh (Contract No. DE-AC01-79ET13547)
G. H. Meier, R. A. Stoehr, E. A. Gulbransen - (412) 624-5316

The object of this program is to develop information about the hot corrosion of high-temperature alloys in the environment likely to be found when a gas turbine is operated on low Btu gas produced from coal in a fluidized bed gasi-

fier. The program is designed to determine the mechanisms of attack and the major factors which influence the kinetics of hot corrosion in these environments.

Keywords: Corrosion

56. Investigation of the Mechanisms of Molten Salt Corrosion of Candidate Materials for Molten Carbonate Fuel Cells FY 1981 0
FY 1982 \$50K

DOE Contact - S. J. Dapkunas, (301) 353-2784; FTS - 233-2784
Oak Ridge National Laboratory (Contract No. W-7405-eng-26)
J. H. DeVan - (615) 574-4451; FTS - 624-4451

This program focuses on the corrosion mechanisms associated with the anode and cathode current collectors in molten carbonate fuel cells. DTA/TGA studies of structural metals in Li_2CO_3 - K_2CO_3 salts will be conducted to establish the sequence of oxidation reactions that occur between the elements Fe, Ni, Cr, and Co and the salt in an oxidizing gas typical of the cathode region. The resistance of NiAl to a thin coating of Li_2CO_3 - K_2CO_3 will be evaluated under reducing (anodic) and oxidizing (cathodic) conditions. Lastly, salt purification techniques and analytical procedures will be developed to permit determinations of the solubilities of structural metal oxides (Fe_3O_4 , Cr_2O_3 , and Al_2O_3) in molten carbonate salt under anodic and cathodic conditions.

Keywords: Fuel Cells, Current Collectors

57. Oxide Electrodes for High Temperature Fuel Cells FY 1981 0
FY 1982 \$103K

DOE Contact - S. J. Dapkunas, (301) 353-2784; FTS - 233-2784
Pacific Northwest Laboratory (Contract No. W-7405-eng-26 Union)
J. L. Bates - (509) 375-2579; FTS - 444-2579

This project is a research effort to find and develop highly electronically conducting oxides with resistance to corrosion in molten alkali metal carbonates. The oxides are to be used as cathodes in molten carbonate fuel cells. Specifically, the work will determine the effects of rare earth (RE) and indium oxide additions on the electrical transport properties and on the corrosion resistance of HfO_2 (ZrO_2)- RE_2O_3 - In_2O_3 . In addition, the study will develop an understanding of the crystallographic, microstructural, and phase equilibrium factors which influence the above properties. Materials will be fabricated for testing under molten carbonate fuel cell conditions.

Keywords: Fuel Cells

58. Materials and Components Newsletter

FY 1981 \$110K
FY 1982 \$133K

DOE Contact - S. J. Dapkunas, (301) 353-2784; FTS - 233-2784
Battelle-Columbus Laboratories (Contract No. DE-AC05-80ET10609)
E. E. Hoffman (DOE/ORO) - (615) 576-0735; FTS - 626-0735
I. G. Wright (BCL) - (614) 424-4377

The purpose of this task is to publish a newsletter to address recent developments in materials and components in fossil energy applications.

Keywords: Materials; Components

59. Materials Research for the Clean Utilization
of Coal; Task 2: Materials Performance and
Properties Data

FY 1981 \$275K
FY 1982 \$267K

DOE Contact - S. J. Dapkunas, (301) 353-2784; FTS - 233-2784
National Bureau of Standards, (Contract No. EA-77-A-01-6010)
S. J. Schneider, H. M. Ondik, R. C. Dobbyn - (301) 921-2892

The goal of this project is to assist the coal conversion industry in extending the useful life and reliability of plant components by maintaining a central source of information on the performance, especially failures, of materials and components used in coal conversion environments.

It will provide an integrated materials properties data base for materials of construction to aid the coal conversion industry in the design, construction, and operation of plants converting coal to alternate energy forms, including MHD power generation.

The project will collect and evaluate the appropriate information, maintain suitable computer files for ready retrieval, and disseminate the data in convenient form to the users.

Keywords: Materials Characterization

Appendix N: Division of Surface Coal Gasification

PROJECT TITLE: PLANTS MATERIALS SURVEILLANCE TESTS \$0 (81) \$460K (82)

DOE Contact - J. Carr (301) 353-5985, FTS 233-5985
Oak Ridge National Laboratory, Oak Ridge, Tennessee
R. A. Bradley - (615) 574-6094, FTS 624-6094
Metal Properties Council, Inc., New York, New York
O. A. Schaefer (212) 644-7694

OBJECTIVE:

To develop a data base to assist in selection of materials for economical construction and reliable operation of commercial coal gasification (CG) plants through the evaluation of metals and refractories in CG pilot plants; to provide a means to correlate laboratory tests, establish materials corrosion/erosion mechanisms and identify effects of plant and process variables on material corrosion.

STATUS:

The selection of construction materials for future coal gasification plants requires that a materials performance data base be developed. Since 1973, The Metal Properties Council, Inc. has conducted a multiphase program to evaluate the resistance of construction materials to coal gasification environments. This MPC program has included the exposure of alloys and refractories in operating coal gasification pilot plants.

For each pilot plant, MPC will perform in-plant exposure tests based on a test plan developed jointly by the MPC subcontractor and the industrial developer of the gasifier. Metals and refractories will be exposed in appropriate test locations in the pilot plants and process conditions will be monitored for each test location. The plants to be included in the test program are Peat-Gas (HYGAS), U-Gas, BiGas, Westinghouse, and Mountain Fuel Resources. Other plants, such as GE-GAS and Exxon, may be included in subsequent tests.

Surveillance testing in the Synthane and CONOCO Coal pilot plants was completed as part of the AR&TD Fossil Energy Materials Program. Two test exposures each were completed in the U-Gas and BiGas plants, and four test exposures were completed in the HYGAS plant.

Topical reports on materials performance in the Synthane and CONOCO Coal pilot plants were prepared. Results of tests completed on metals were published.

This is a new coal gasification project initiated in FY 82 which is essentially a continuation of an earlier ARTD project.

PROTECTIVE COATINGS AND CLADDINGS - APPLICATION/EVALUATION \$0 (81) \$550K (82)

DOE Contact J. Carr (301) 353-5985, FTS 233-5985
Argonne National Laboratory, Argonne, Illinois
Dr. W. A. Ellingson (312) 972-5068, FTS 972-5068
Lockheed Palo Alto Research Laboratory
Dr. Roger Perkins (415) 493-4411

OBJECTIVE:

To develop reliable application methods and materials for coating and/or cladding gasification constituent elements/components for temperature, corrosion and erosion protection and thereby enhance economic and reliable construction and operation of coal gasification plants.

STATUS:

A number of coating and cladding materials have been identified through laboratory experiments for possible application to gasification pilot plant components, such as cyclones, dip legs, heat exchangers, pipes, valves, and instrumentation probe plants. Several coating, cladding and weld overlay development programs were sponsored by the AR&TD Fossil Energy Materials program. Lockheed Palo Alto Research Laboratory developed Fe/CoCrAlY(Hf) coatings and FeCrAlHf claddings that showed excellent corrosion resistance in low- to medium-Btu simulated coal gasification environments for up to 2000 h at 1600-1800 degrees F. Interdiffusion, however, limits the lifetime beyond 2000 h. Further work will be required to extend the useful lifetime to at least 10,000 h. International Nickel Corp. (INCO) developed higher chromium nickel-based alloys for use as weld overlays. These compositions have shown good corrosion resistance for up to 1000 h in a high-Btu environment at 1800 degrees C, but their performance in low- to medium-Btu environments have not been evaluated.

Laboratory and field testing through methods and materials introduced under AR&TD programs will be developed so that they can be readily used on a commercial basis. Bonding, mechanical integrity, and microstructural characteristics will be extensively examined before and after tests. As the coatings/claddings and weld overlay techniques exhibit satisfactory performance in a gasifier environment, they will be identified and the technology will be transferred to appropriate industries for commercial applications. Furnace-fused coating compositions and the substrate types will be tested in order to establish requirements for elimination of void formation and interface separation. Laser surface-fused CoCrAlHf(Y) coatings will be prepared to establish requirements for crack-free deposits. Test samples will be prepared with a two-layer, laser-fused coating. Weld overlay tests using FeCrAlHf clad Alloy 800 will be used to establish practices for weld deposition on cut edges and over base metal. Weld overlay will be developed. Alternative coatings (e.g., ceramic coatings) and coating procedures will be examined for possible application in gasifier components.

New coal gasification project initiated in FY 82 based on earlier ARTD project.

CERAMIC FABRICATION/APPLICATION TECHNOLOGY - SUBTASK A \$0 (81) \$200K (82)
LOCKHOPPER VALVES

DOE Contact, J. Carr (301) 353-5985, FTS 233-5985
Los Alamos National Laboratory, Los Alamos, New Mexico
Frank D. Gac, (505) 667-5126, FTS 843-5126

OBJECTIVE:

To develop and apply ceramic technology to coal gasification plant components to achieve higher reliability, durability, and lower cost under very high temperature and extreme erosive, corrosive conditions by developing special brittle materials (ceramic) design methodology and fabrication methods and integrally effecting exploratory development of critical components, such as lockhopper valves.

STATUS:

One area that is key to the successful commercialization of coal gasification is valving, in particular, the type III lockhopper valve. The erosive/corrosive conditions, coupled with elevated temperature, suggest ceramics should be utilized for this application. Attempts by other researchers to address this problem met with poor success due to a basic unfamiliarity of designing with ceramics. The investigators in this program intend to mesh extensive materials fabrication expertise with state-of-the-art brittle materials design knowledge to address the type III lockhopper valve problem.

This is a new coal gasification project initiated in FY 82.

CERAMIC FABRICATION/APPLICATION TECHNOLOGY - TASK B - \$0 (81) \$300K (82)
HEAT EXCHANGER

DOE Contact, J. Carr (301) 353-5985, FTS 233-5985
Argonne National Laboratory, Argonne, Illinois
Dr. W. A. Ellingson, (312) 972-5032, FTS 472-5068
Solar Turbine International, San Diego, California
Mike Ward, (714) 238-5572

OBJECTIVES:

To develop and apply ceramic technology to coal gasification plant components to achieve higher reliability, durability, and lower cost under very high temperature and extreme erosive, corrosive conditions by developing special brittle materials (ceramic) design methodology and fabrication methods and integrally effecting exploratory development of critical components such as heat exchangers.

STATUS:

Design methodology for structural components made from brittle material requires a different approach than when ductile materials are used. Although the design methodology required for ceramics is relatively new, developments in design methodology for brittle materials over the past 10 years for other components appear to be applicable to heat-exchanger design. Recent approaches

to brittle materials design have evolved from the high-temperature ceramic gas turbine work which began under ARPA funding in the early 1970's and continues today with DOE Conservation Funding under the program "Brittle Materials Design, High-Temperature Gas Turbine." The approach taken in the program has been to apply finite element computer codes to the heat transfer and stress analysis of a prospective component. In conjunction with computer analysis, materials properties of candidate materials are carefully measured. Because strength data on brittle ceramics vary widely due to the distribution of flaws in the ceramics, a statistical approach is taken to the correlation of measured strength data with the probability of existence of critical flaws in the material.

Feasibility was demonstrated (under an earlier ARTD project) for constructing large SiC heat-exchanger modules which possess capabilities required for heat exchangers, namely minimum cross leakage and gas permeability, resistance to shock by thermal transients, and ability to withstand 100 psig internal pressure at operating temperatures of 2500 degrees F.

This is a new coal gasification project initiated in FY 82 based on the earlier ARTD effort. The silicon carbide heat exchangers built by Solar Turbines, Inc. will be retubed with finned ceramic tubes and tested to obtain material performance data relative to heat transfer, leakage (pressure drops), effectiveness, and structural integrity. Mechanical tests will be conducted on various components (headers, finned and smooth tubings, joints and header transitions pieces) to validate the design methodology. The structural, thermal, and hydraulic analyses used in the design of the ceramic heat exchanger will provide the basis for a design methodology. Materials design data in a gasifier environment will be obtained.

SLAGGING REFRACTORIES

\$0 (81) \$400K (82)

DOE Contact, J. P. Carr, (301) 353-5983, FTS 233-5985
Argonne National Laboratory, Argonne, Illinois
Dr. W. A. Ellingson, (312) 972-5068, FTS 972-5068

OBJECTIVES:

To develop the technology to attain an adequate life (minimum of 1 year) for refractories to line the main pressure vessels of slagging coal conversion systems with minimum cost and use of critical materials and thereby realize the greater efficiencies and economics achievable in slagging gasification systems.

STATUS:

Refractories used in main process vessels of slagging coal gasifiers are subjected to extremely hostile environments. Temperatures of 1400-1750 degrees C, highly corrosive coal slags, and highly reducing multicomponent gas atmospheres pose difficult challenges for any material. Of all the potential refractory failure mechanisms, corrosion by coal slags and thermal shock appear to be the most serious and most difficult to solve effectively.

Tests to date have not been able to separate performances of these six best refractories despite significant differences in their microstructures and

bonding. More aggressive accelerated testing methods are being developed. These tests emphasize the synergism between the corrosion and erosion aspects of degradation. Further, qualitative observations made after corrosion tests indicate that high chromia refractories possess very poor thermal shock characteristics. Data are currently available to rank the sensitivity of the candidate refractories to thermal shock damage.

New Coal Gasification project initiated in FY 82 based on earlier ARTD project/work.

PROCESS PLANT MATERIALS REVIEW, EVALUATION, AND SUPPORT \$0 (81) \$225K (82)

DOE Contact, J. Carr, (301) 353-5985, FTS 233-5985
Argonne National Laboratory, Argonne, Illinois
Dr. W. A. Ellingson, (312) 972-5068, FTS 972-5068
Oak Ridge National Laboratory, Oak Ridge, Tennessee
R. A. Bradley, (615) 574-6094, FTS 624-6094

OBJECTIVE:

To review and evaluate the performance of pilot plants to establish the data base to define materials requirements and guide respective development efforts for the ultimate construction of more reliable, economic, efficient, and safe coal gasification plants.

STATUS

Selection of materials, components, and instrumentation for operating coal gasification pilot plants was based on experience gained in the fossil-fueled power and petrochemical industries. In many instances, these selections are inadequate for commercial plants. Assessment and documentation of performance in operating plants is needed for a data base to design subsequent commercial plants as well as to provide guidance in establishing needed R&D programs.

The first step in this task will be a thorough baseline audit of each coal gasification process selected to identify the significant materials requirements and likely materials problem areas. These areas will then be analyzed to define the anticipated service conditions and potential failure modes and to determine whether additional materials development is required. After the process audit is completed, the materials requirements of the corresponding pilot or demonstration plant will be reviewed. Materials testing and problem areas will be defined, and technology gaps identified. Materials testing and surveillance activities in the plants will be initiated where appropriate, and gaps in plant operating data needed to better define materials service conditions in critical components will be determined. Ongoing follow-up activities will then be carried out to ensure that the necessary operating data are collected and that any materials performance and surveillance tests initiated are properly conducted and analyzed. Reviews, testing, and analysis activities will be documented in a series of reports for each coal gasification process.

New Coal Gasification project initiated in FY 82.

DOE Contact, J. P. Carr, (301) 353-5985, FTS 233-5985
Oak Ridge National Laboratory, Oak Ridge, Tennessee
R. A. Bradley, (615) 574-6094, FTS 624-6094

OBJECTIVE:

To advance pressure vessel forming technology to attain more economic and readily fabricated full scale coal gasification system vessels through the use of higher strength materials and alternate fabrication techniques.

STATUS:

The current candidate material for gasification pressure vessels is a 2-1/4 Cr-1 Mo steel (SA-387 grade 22 class 2). The A542 specification for 2-1/4 Cr-1 Mo steel describes higher strength versions of this steel, and the use of this A542 material would allow increases in design stress intensities above the SA-387 material. The higher strength versions of 2-1/4 Cr-1 Mo steel are not currently approved for pressure vessel construction in the ASME Code, primarily because of an insufficient data base.

This task will provide the materials data base that is necessary to obtain ASME Code approval of a high-strength pressure vessel steel (A542). This stronger grade of steel will result in thinner wall vessels, thus reducing the cost of materials and fabrication.

This new Coal Gasification project was initiated during FY 82.

APPENDIX O: Office of Breeder Reactor Technology:
Fuels and Core Materials Division

The Fuels and Core Materials Division materials program described in the following FY 1981 and 1982 Budget Summary are directed at providing technical support on materials required for the design of reliable, safe and economical fast breeder reactor plants and their operation. The funding for core component materials, such as reactor fuels, absorbers, cladding and ducts, at various contractors, national laboratories and government laboratories is as follows:

1. Advanced Fuels - Transients \$ 600 (81); \$ 200 (82)

DOE Contact: R. J. Neuhold, (301) 353-4471; FTS 233-4471
Argonne National Laboratory (Contract No. W-31-109-ENG-38)
L. Neimark, S. M. Gehl - (312) 972-5199; FTS 972-5199

Keywords: Ceramics, Glasses; Radiation Effects

2. Advanced Fuels - Transients \$ 150K (81); \$ 180K (82)

DOE Contact: R. J. Neuhold, (301) 353-4471; FTS 233-4471
Atomics International (Contract No. DE-AT03-76SF76026)
W. Wolfe, E. Specht, B. Ostermeir - (213) 341-1120; FTS 791-1120

Fabricate advanced fuel blanket pellets for carbide blanket fuel assembly testing. Perform pin evaluation and pin code development.

Keywords: Ceramics, Glasses; Fuel Development, Uranium Carbide,
Pin Evaluation, Code Development

3. Advanced Fuels - Steady State \$ 300K (81); \$ 200K (82)
DOE Contact: R. J. Neuhold, (301) 353-4471; FTS 233-4471
Combustion Engineering Company (Contract No. DE-AT02-76-CH91001)
S. A. Caspersson - (203) 688-1911

Assess an extended lifetime advanced oxide fuel system.

Keywords: Ceramics, Materials Characterization
4. Alloy Development \$ 364K (81); \$ 300K (82)
DOE Contact: R. J. Neuhold, (301) 353-4471; FTS 233-4471
General Electric Company (Contract No. DE-AT03-76SF1031)
E. A. Aitken - (408) 738-4238; FTS 738-7238

Perform examinations and analysis of creep-in-bending test, and assess post-irradiation ductility of advanced alloys for core components.

Keywords: Radiation Effects, Materials Characterization
5. Advanced Fuels Development \$1,390K (81); \$2,250K (82)
DOE Contact: R. J. Neuhold, (301) 353-4471; FTS 233-4471
General Electric Company (Contract No. DE-AT03-76SF1031)
E. A. Aitken - (408) 738-4238; FTS 738-7238

Design, irradiate and evaluate advanced oxide fuels, and blankets under specific conditions of neutron irradiation. Tests are focused on providing data for design and licensing in the areas of thermal performance, mechanical performance, chemical effects and run-beyond-cladding breach.

Keywords: Ceramics, Fuel Development, Radiation Effects
6. Alloy Development \$3,814K (81); \$3,500K (82)
DOE Contact: R. J. Neuhold, (301) 353-4471; FTS 233-4471
Hanford Engineering Development Laboratory (Contract No. DE-AC14-76FF02170)
J. L. Straalsund - (509) 376-3306; FTS 444-3306

Characterize the in-reactor deformation behavior of breeder reactor cladding and duct materials. Work emphasizes measurement of in-reactor swelling, creep, and post-irradiation mechanical properties such as tensile behavior and fracture toughness. Irradiation resistance of tailored commercial and development alloys is investigated.

Keywords: Radiation Effects, Materials Characterization

7. Reference Fuels \$3,139K (81); \$4,080K (82)
- DOE Contact: R. J. Neuhold, (301) 353-4471; FTS 233-4471
Hanford Engineering Development Laboratory (Contract No. DE-AC14-76FF02170)
C. M. Cox - (509) 376-0384; FTS 444-0384
- Design, fabricate, irradiate, examine and evaluate standard FFTF driver fuel. Conduct special tests such as high power, power-to-melt and Fuel Open Test Assembly experiments. These experiments cover both steady-state and transient conditions.
- Keywords: Ceramics, Materials Characterization
8. Advanced Fuels \$3,175K (81); \$3,090K (82)
- DOE Contact: R. J. Neuhold, (301) 353-4471; FTS 233-4471
Hanford Engineering Development Laboratory (Contract No. DE-AC14-76FF02170)
C. M. Cox - (509) 376-0384; FTS 444-0384
- Design, fabricate, irradiate, and examine advanced driver fuel. Perform post-irradiation examination of advanced breached fuel pins.
- Keywords: Ceramics, Radiation Effects
9. Absorbers \$1,256K (81); \$ 910K (82)
- DOE Contact: A. VanEcho, (301) 353-3930; FTS 233-3930
Hanford Engineering Development Laboratory (Contract No. DE-AC14-76FF02170)
M. Parker - (509) 376-3238; FTS 444-3238
- Design, fabricate, irradiate absorber pellets, pins and assembly experiments for reference and advanced breeder reactor control rod concepts. This experimental work includes physical and mechanical property evaluation of boron carbide and related materials.
- Keywords: Ceramics, Radiation Effects, Materials Characterization
10. Fuel Support Technology \$2,145K (81); \$1,020K (82)
- DOE Contact: R. J. Neuhold, (301) 353-4471; FTS 233-4471
Hanford Engineering Development Laboratory (Contract No. DE-AC14-76FF02170)
C. M. Cox - (509) 376-0384; FTS 444-0384
- Obtain by laboratory measurements, properties data required for design, performance analysis and fabrication of fuel and blanket materials. Develop analytical relationships to describe experimental data compatible with performance codes and models. Review, evaluate and recommend properties data for non-metallic fuel/blanket materials.
- Keywords: Materials Characterization

11. Fuel Fabrication \$1-,240K (81); \$13,250K (82)
- DOE Contact: W. M. Hartman, (301) 353-5198; FTS 233-5198
Hanford Engineering Development Laboratory (Contract No. DE-AC14-76FF02170)
L. Rice - (509) 376-1911; FTS 444-1911
- Design, develop and build an automated fuel pin fabrication facility. The facility will incorporate advanced equipment and techniques designed to reduce personnel exposure and maximize special nuclear materials safeguards.
- Keywords: Materials Processing
12. Program Management \$1,424K (81); \$ 800K (82)
- DOE Contact: R. J. Neuhold, (301) 353-4471; FTS 233-4471
Hanford Engineering Development Laboratory (Contract No. DE-AC14-76FF02170)
D. E. Mahagin - (509) 376-0384; FTS 444-0384
- Draft and implement multi-year program and test plan.
- Keywords: Program Plan
13. Post Irradiation Examination, Deactivation and Storage of Carbide Fuel \$2,145K (81); \$1,020K (82)
- DOE Contact: R. J. Neuhold, (301) 353-4471; FTS 233-4471
Los Alamos National Laboratory (Contract No. W-7405-ENG 36)
J. L. Green, W. T. Wood - (505) 667-2610; FTS 843-2610
- Conduct hot cell operations. Deactivate carbide fuel/blanket fabrication facilities.
- Keywords: Ceramics, Materials Processing, Materials Fabrication
14. Reference Fuels \$2,145K (81); \$1,020K (82)
- DOE Contact: R. J. Neuhold, (301) 353-4471; FTS 233-4471
Hanford Engineering Development Laboratory (Contract No. DE-AC14-76FF02170)
C. M. Cox - (509) 376-0384; FTS 444-0384
- Obtain by laboratory measurements, properties data required for design, performance analysis and fabrication of fuel and blanket materials. Develop analytical relationships to describe experimental data compatible with performance codes and models. Review, evaluate and recommend properties data for non-metallic fuel/blanket materials.
- Keywords: Materials Characterization

15. Fuel/Blanket Assembly Development

\$2,615K (81); \$2,590K (82)

DOE Contact: R. J. Neuhold, (301) 353-4471; FTS 233-4471
Westinghouse Advanced Reactors Division (Contract No. EY-76-C-02-3045-M)
A. Boltax - (412) 722-5363; FTS 726-5363

Design, fabricate and test performance of oxide fuel subassemblies in support of the national effort on advanced fuels development. Perform design, thermal-hydraulic analysis, and fabrication of blanket fuel assemblies. Develop and verify pin life codes.

Keywords: Ceramics, Materials Processing, Materials Characterization

Appendix P: Office of Breeder Technology Projects: Materials and Structure Program

The Breeder Mechanical Component Development Division, under the Office of Breeder Reactor Technology Projects is responsible for overall program management of the Materials and Structures Program. The objectives of the Program are to (1) provide technologies to assure LMFBR components and systems will be safe and reliable during their design lifetime; (2) provide LMFBR designers and manufacturers with materials, methods, procedures, tools and criteria that are consistent with good economics, are not overly conservative, and provide for broad component design flexibility; and (3) provide an improved technological basis for licensing. R&D programs for FY 1981 and FY 1982 in the material area are described below.

1. Mechanical Properties Design Data \$2894K (81), \$2570K (82)

DOE Contact: C. Beals, (391) 353-4329, FTS 233-4329
Argonne National Laboratory, Chicago, IL, Tom Kassner, FTS 972-5191
GE/ARSD, Sunnyvale, CA, Peter Ring, (408)-925-2330
Hanford Engineering Development Laboratory, Richland, WA, L. Blackburn,
FTS 444-3335
Idaho National Engineering Laboratory, Idaho Falls, ID, G. Korth,
FTS 583-0345
Naval Research Laboratory, Washington, DC, D. Michel, (202) 767-2621
Oak Ridge National Laboratory, Oak Ridge, TN, C. Brinkman, FTS 624-5106
Westinghouse-Advanced Reactors Division, Madison, PA, W. Ray,
(412) 722-5512

OBJECTIVES: Generate materials properties data to support the development and implementation of high temperature structural design methods and criteria. Characterization of the deformation and failure characteristics of reference structural materials. Environments considered include irradiation, steam, sodium and elevated temperature.

STATUS: The materials properties which are being measured are physical properties, yield strength, tensile strength, fatigue, creep rupture, creep-fatigue, impact strength, and fracture mechanics properties. The materials under consideration are Type 304 stainless steel, Type 316 stainless steel, ferritic 2-1/4 Cr-1 Mo steel, ferritic 9 Cr-1 Mo (modified) steel, A-286 steel, Alloy 800 steel and Alloy 718 steel. Also, Type 308 stainless steel, Type 16-8-2 stainless steel, and INCO 82 steel and their weldments. In addition, transition weld joints between ferritic steel and austenitic stainless steel are being characterized.

Keywords: Materials Characterization, Radiation Effects, Mechanical Properties.

2. Fabrication Technology \$735K (81), \$480K (82)

DOE Contact: C. Beals, (301)-353-4329, FTS 233-4329
GE/ARSD, Sunnyvale, CA, Peter Ring, (408)-925-2330
Idaho National Engineering Laboratory, Idaho Falls, ID, H. Smartt,
FTS 583-8333
Oak Ridge National Laboratory, Oak Ridge, TN, G. Goodwin, FTS 624-4809

OBJECTIVE: Develop improved methods and procedures for fabricating LMFBR piping systems. Develop designs and fabricating methods for transition joints between piping sections of ferritic and austenitic materials. Develop materials for welding austenitic stainless steels which have improved properties at LMFBR operating temperatures.

STATUS: The products from several commercial methods of fabricating austenitic stainless steel pipe have been evaluated and characterized. Fabrication methods have been developed for making ferritic 2 1/4 Cr-1 Mo/Alloy/800/Type 316 stainless steel transition joints and thermal transient testing of prototypical size joints has been conducted. Materials properties of several Controlled Residual Element (CRE) austenitic stainless steel weld materials have been determined.

Keywords: Joining Methods, Fabrication, Welding.

3. Nondestructive Testing Technology \$935K (81), \$695K (82)

DOE Contact: C. Beals, (301) 353-4329, FTS 233-4329
Argonne National Laboratory, Chicago, IL, Karl Reimann, FTS 972-5066
Hanford Engineering Development Laboratory, Richland, WA, S. Mech,
FTS 444-0506
Oak Ridge National Laboratory, Oak Ridge, TN, R. McClung, FTS 624-4466

OBJECTIVE: Develop methods, techniques and equipment for inspection of LMFBR components during manufacture and for periodic in-service inspection after plant construction.

STATUS: Emphasis is on development of rod-anode radiographic techniques for tube-to-tubesheet welds for heat exchangers in the radiography area.

Emphasis in the eddy-current area is on the development of flaw detection capability for steam generator single and double wall tubes made from ferritic 2-1/4 Cr-1 Mo material.

Emphasis in the ultrasonic testing area is in the development of both wall thickness and flaw detection capability for ferritic steam generator tubing and flaw detection capability for stainless steel pipe.

Keywords: Nondestructive Evaluation, Inspection.

4. Tribology Technology \$285K (81), \$170K (82)

DOE Contact: C. Beals, (301) 353-4329, FTS 233-4329
Hanford Engineering Development Laboratory, Richland, WA, R. Johnson,
FTS 444-5188
Westinghouse-Advanced Reactors Division, Madison, PA, S. Shiels,
(412) 722-5377

OBJECTIVE: To qualify wear-resistant materials and processes for LMFBR applications.

STATUS: Testing has been conducted on aluminized ferritic 2-1/4 Cr-1 Mo material to be used for steam generator tube support plates and on spark deposited coatings for valve applications.

Keywords: Erosion and Wear, Tribology.

5. Coolant/Technology \$165K (81), \$205K (82)

DOE Contact: C. Bigelow, (301) 353-4299, FTS 233-4299
GE/ARSD, Sunnyvale, CA, P. Roy, (408) 925-5181

OBJECTIVES: (1) To develop appropriate water chemistry specifications, analytical instrumentation, and operating procedures to ensure the integrity and reliability of LMFBR steam generators; and (2) to determine carbon transport behavior in bimetallic LMFBR hot sodium systems and effects of decarburization on 2-1/4 Cr-1 Mo steel steam generator material.

STATUS: Testing has been conducted on ferritic 2-1/4 Cr-1 Mo tubing for steam generators in caustic environment and on an LMFBR intermediate sodium system mockup loop.

Keywords: Corrosion.

6. Advanced Alloy Technology \$794K (81), \$590K (82)

DOE Contact: C. Beals, (301)-353-4239, FTS 233-4329
Oak Ridge National Laboratory, Oak Ridge, TN, V. Sikka, FTS 624-5112

OBJECTIVE: Develop a modified 9 CR-1 Mo alloy steel as a structural material for LMFBR plant systems, and as an alternative to the current reference materials, i.e. austenitic stainless steels and 2 1/4 Cr-1 Mo alloy steel.

STATUS: The development effort on this alloy was initiated in 1977 and is concentrated in five major areas. These development areas are preparation/fabrication, mechanical/physical properties, design methods, joining behavior and corrosion behavior. Application has been made to the ASTM for a specification for the material and the data packages for application to the ASME Code Sections I, III and VIII for code acceptance of the material will be completed in FY 1982.

Keywords: Alloy Development, Alternate Materials, Materials Characterization.

7. Documentation \$355K (81), \$320K (82)

DOE Contact: C. Beals, (301)-353-4329, FTS 233-4329
Hanford Engineering Development Laboratory, Richland, WA, T. Bierlein,
FTS 444-3447
Oak Ridge National Laboratory, Oak Ridge, TN, M. K. Booker, FTS 624-5113

OBJECTIVE: To coordinate and maintain a system for documenting materials data to provide an authoritative data source for use in the design and construction of nuclear power plant system.

STATUS: The documentation process is ongoing and continues to furnish updated data for use in the design and construction of nuclear power plant systems.

Keywords: Materials Characterization, Materials Data Documentation.

APPENDIX Q: Office of Space Nuclear Projects

This Office is responsible for both Space and Terrestrial system power sources based on radioisotopic thermoelectric heat convertors or advanced space power reactors. Funding is shown below for FY 1982.

1. Iridium Alloy Processing and Fabrication - \$1610

DOE Contact: G. Bennett (301) 353-3197; FTS 233-3197

Contractor: Oak Ridge National Laboratory
R. H. Cooper (615) 574-4470; FTS 624-4470

Contract: W-7405-eng-26

Iridium alloys doped with Th and Al are processed from purchased high purity iridium powder. Product is sheet processed via electron beam plus arc-cast melting. Production is under Processing Configuration Control in accord with Processing and Quality Assurance Specifications assuring nuclear/aerospace quality in the product. This effort is closely scheduled and integrated with system projects.

Keywords: Material Processing, Quality Assurance

2. Carbon Bonded Carbon Fiber Insulation (CBCF-3) - \$375

DOE Contact: G. Bennett (301) 353-3197; FTS 233-3197

Contractor: Oak Ridge National Laboratory
R. H. Cooper (615) 574-4470; FTS 624-4470

Contract: W-7405-eng-26

CBC-3 carbon fiber insulation in the 0.02-0.24 gm/cm³ density range is produced for assembly in space flight system radioisotopic thermoelectric power generators (RTG's). All processing is under Production Configuration Control in accord with Processing and Quality Specifications assuring nuclear/aerospace quality in the product.

Keywords: Material Processing, Quality Assurance

3. General Purpose Heat Source - \$2,000

DOE Contact: G. Bennett (301) 353-3197; FTS 233-3197

Contractor: Los Alamos National Scientific Laboratory
S. Bronisz (505) 667-4782; FTS 843-4782

Contract: AL-7405-eng-36

Assembly and testing of ²³⁸PuO₂ fuel bodies encapsulated in iridium alloy clad vent sets and inserted into fine weave pierced fabric graphites was conducted using developmental heat source components. Testing included system compatibility, high temperature - high strain rate impact studies. Launch incident evaluations have included and will include launch pad abort fire, reentry impact, blast overpressure, sequential testing and component qualifications tests.

Keywords: Ceramics, Materials Characterization

4. Space Nuclear Reactor Power System Technology Program (SP-1000 - \$2000

DOE Contact: Lt. Col. R. E. Smith, Jr. (USAF) (301) 353-4021;
FTS 233-4021

Contractor: Los Alamos National Scientific Laboratory
D. Buden (505) 677-5540; FTS 843-5540

Contract: AL-7405-eng-36

Lithium-Mo and Li Mo+13 RE heat pipes containing wire wicks are under development for the SP-100 reactor core. These heat pipes are essential components of the SP-100 design targeted for future Space Shuttle launch. Wire mesh artery heat pipe performance testing will continue during the fiscal year.

Keywords: Materials Characterization

APPENDIX R: Division of Waste Repository Deployment

The National Waste Terminal Storage (NWTS) Program provides the technology and facilities necessary to meet all applicable safety and environmental requirements for the long-term management of nuclear waste. The wastes include these from both the commercial and the defense nuclear activities of this nation. In broad scope the materials activities support: waste packaging, interim storage, and disposal; and evaluates existing structural materials and geologic formation.

The major objectives for waste disposal are: (1) to select suitable geohydrologic regions to minimize the release of radioactivity in the event of failure of the containment systems; (2) to select suitable geologic formations within satisfactory geohydrologic regions to contain the waste; (3) to design the repository to minimize the effect of mining and waste emplacement of the integrity of the geologic formation; and (4) to provide an engineered system as a backup to the geologic formation to contain the waste within the package for sufficient time to allow for decay of major radioactive nuclides.

1. Waste Isolation

DOE Contract - C. R. Cooley (301) 353-4285; FTS 233-4285
Division of Waste Repository Deployment

The materials activities related to Waste Isolation include:

- o Migration of radioactive waste through geohydrologic systems
- o Thermomechanical response of geologic formations
- o Engineered barriers for waste containment within the repository
- o Waste packaging materials and fabrication processes for spent nuclear fuel and for the containerized high-level and transuranic wastes for emplacement in geologic environment

Details, Contracts, and Funding for the Elements in Waste Isolation Follow:

1A. Waste Migration Rates

Waste Transport

Waste Migration: PNL, SL, LLL, LASL, RHO, ORNL, University of New Mexico, Battelle Memorial Institute

The materials characteristics of the geohydrology and geologic formation are evaluated using geophysical measurements and drilling operations. The measurements of the ion exchange capability of the geologic media delays the rate of migration of radioactivity sufficiently that all but the very long lived

radioactivity would decay below natural levels before release to the biosphere. The rock formation of interest include basalt, salt, and tuff.

Keywords: Ceramics, Materials Characterization, Radiation Effects, Corrosion

1B. Thermomechanic Response of Rocks

82 \$5,900

DOE Contract - W. Eister (301) 353-3188; FTS 233-3188
RE/SPEC, LLL, RHO, LBL, USGS, Colorado School of Mines

The effect of mining and waste emplacement is of concern as it relates: (1) to the stability of the mined openings in the rock, and (2) to the suitability of the rock and its associated hydraulic conductivity. Since there is considerable experience as related to mining effects, the primary attention is directed to the thermomechanics response of the rocks. The heat will result from the decay of radioactive waste. The thermomechanic property and the effect on the related hydraulic conductivity are being studied in the laboratory and in deep geologic formations.

Keywords: Materials Characterizations, Ceramics

1C. Waste Package

81 \$1,500

Engineered Barriers

82 \$7,800

DOE Contract - W. Eister (301) 353-3188; FTS 233-3188
HELD, SL, PNL, RHO, Penn State University, Westinghouse, ANL

The objective of this activity is to seal the spent fuel in an overpack container compatible with the geologic environment. The property of principal interest is corrosion resistance of the overpack container, however, there are also significant efforts on the other components of the package and the engineered barriers, steel and titanium, alloys are the principal candidates at this time. These studies include:

- o Leach rate of the UO_2 in the spent fuel
- o The characteristics of the zirconium clad
- o Backfill materials between the overpack and rock to limit the access of groundwater to the overpack and/or retard the transport of radioactivity from a failed package; a bentonite-sand mixture is a typical candidate.

In addition, materials are being evaluated to seal the repository. Concrete is the principal material being used in these studies.

Keywords: Cements and Concrete, Corrosion, Hydrogen Effects, Joining Methods, Materials Characterization, Materials Processing, Non-Destructive Evaluation, Radiation Effects

ENERGY MATERIALS COORDINATING COMMITTEE (EMACC)

**Contractors Meeting on
Problems and Opportunities
in Structural Ceramics**

**September 29-30, 1982
Department of Energy Headquarters
Germantown, Maryland**

Published: April 1983

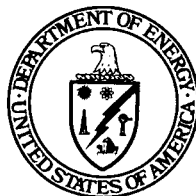

**U.S. Department of Energy
Office of Energy Research
Division of Materials Sciences**

DISCLAIMER

"This report was prepared as an account of work sponsored by an agency of the United States Government. Neither the United States Government nor any agency thereof, nor any of their employees, makes any warranty, express or implied, or assumes any legal liability or responsibility for the accuracy, completeness, or usefulness of any information, apparatus, product, or process disclosed, or represents that its use would not infringe privately owned rights. Reference herein to any specific commercial product, process, or service by trade name, trademark, manufacturer, or otherwise, does not necessarily constitute or imply its endorsement, recommendation, or favoring by the United States Government or any agency thereof. The views and opinions of authors expressed herein do not necessarily state or reflect those of the United States Government or any agency thereof."

This report has been reproduced directly from the best available copy.

Available from the National Technical Information Service, U. S. Department of Commerce, Springfield, Virginia 22161.

Price: Printed Copy A13
Microfiche A01

Codes are used for pricing all publications. The code is determined by the number of pages in the publication. Information pertaining to the pricing codes can be found in the current issues of the following publications, which are generally available in most libraries: *Energy Research Abstracts, (ERA)*; *Government Reports Announcements and Index (GRA and I)*; *Scientific and Technical Abstract Reports (STAR)*; and publication, NTIS-PR-360 available from (NTIS) at the above address.

ENERGY MATERIALS COORDINATING COMMITTEE (EMACC)

**Contractors Meeting on
Problems and Opportunities
in Structural Ceramics**

**September 29-30, 1982
Department of Energy Headquarters
Germantown, Maryland**

Published: April 1983



**U.S. Department of Energy
Office of Energy Research
Division of Materials Sciences
Washington, D.C. 20545**

AN APPRECIATION

We are grateful to the 244 individuals that participated in the Energy Materials Coordinating Committee Contractors Meeting on Problems and Opportunities in Structural Ceramics on 29 and 30 September 1982 at Germantown, Maryland for their contributions to the constructive dialogue at this Meeting and in the assembly of this Report.

We are indebted to Mrs. Janet B. Venneri for her efficient coordination of the correspondence, registration, and report preparation for this Meeting.

Robert J. Gottschall
Meeting Organizer

TABLE OF CONTENTS

EMACC CONTRACTORS MEETING ON PROBLEMS AND OPPORTUNITIES
IN STRUCTURAL CERAMICS

29 AND 30 SEPTEMBER 1982
AT AUDITORIUM
DEPARTMENT OF ENERGY HEADQUARTERS
GERMANTOWN, MARYLAND

	<u>Page</u>
INTRODUCTION: James S. Kane, Deputy Director DOE Office of Energy Research	1
DOE PROGRAM OVERVIEWS: Status of present DOE funded basic and applied, research and development and prognosis for future: Stanley J. Dapkunas (DOE) presiding	
Combustion Zone Durability Program: John W. Fairbanks (DOE)	4
Energy Conversion and Utilization Technologies Materials Project- Ceramics Research: James J. Eberhardt (DOE) and Joseph A. Carpenter (ORNL)	38
Fossil Energy Structural Ceramics Program: Stanley J. Dapkunas (DOE), Ron A. Bradley (ORNL), and James P. Carr (DOE)	51
Ceramics in the Vehicle Propulsion Technology Development Program and a Preview of a Heat Engine Ceramic Technology Program Plan: Robert B. Schulz (DOE)	71
Basic Materials Sciences Structural Ceramics Research: Robert J. Gottschall (DOE)	105
OTHER AGENCY AND FOREIGN OVERVIEWS: James J. Eberhardt (DOE) presiding	
Overview of DOD Programs on Structural Ceramics: Edward M. Leno, e, Army Materials and Mechanics Research Center	131
Review of NASA Programs on Structural Ceramics: Thomas J. Miller (NASA)	145
Overview of German Program - Ceramics Components for Vehicular Gas Turbines: Edward M. Leno, e, Army Materials and Mechanics Research Center	154
Overview of Japanese Structural Ceramics Research: Robert J. Gottschall (DOE)	163

DOE COLLABORATIVE RESEARCH CENTERS AND CAPABILITIES FOR CERAMIC SPECIMEN PREPARATION, ANALYSIS, AND CHARACTERIZATION: Mark C. Wittels (DOE) presiding	
DOE Collaborative Research Centers: Don M. Parkin (DOE)	172
High Temperature Materials Laboratory and Ceramic Specimen Preparation at Oak Ridge National Laboratory: Victor J. Tennery (ORNL)	201
Capabilities for Ceramic Specimen Preparation and Characterization at Los Alamos National Laboratory: John J. Petrovic (LANL)	209
PANEL DISCUSSION ON NEW DIRECTIONS FOR FABRICATION RELIABILITY	224
Moderator: Roy W. Rice (Naval Research Laboratory)	
Panelists: Richard J. Charles (General Electric Corp.)	
Peter W. Heitman (Detroit Diesel Allison of General Motors)	
Frederick F. Lange (Rockwell International)	
Carr Lane Quackenbush (General Telephone and Electronics)	
David W. Richerson (AiResearch Manufacturing Co.)	
Richard C. Phoenix (Carborundum Co.)	
PANEL DISCUSSION ON CIVILIAN MARKET ANALYSIS FOR STRUCTURAL CERAMICS	227
Moderator: John W. Fairbanks (DOE)	
Panelists: Lawrence R. Johnson (Argonne National Laboratory)	
James I. Mueller (University of Washington)	
Karsten H. Styhr, Jr. (AiResearch Casting Co.)	
An Overview of the Market Potential for Structural Ceramics: Larry R. Johnson, Argonne National Laboratory	228
Civilian Market Analysis for Structural Ceramics: Karsten H. Styhr and John Mason, AiResearch Casting Company	235
PANEL DISCUSSION OF DOMESTIC CERAMIC PRODUCERS AND ENGINE MANUFACTURERS	244
Moderator: Robert B. Schulz (DOE)	
Panelists: Anthony G. Evans (Lawrence Berkeley Laboratory)	
Roy Kamo (Cummins Engine Co.)	
John G. Lanning (Corning Glass Works)	
David C. Larsen (Illinois Institute of Technology Research Institute)	
Maurice L. Torti (Norton Co.)	
Thomas J. Whalen (Ford Motor Co.)	

PANEL DISCUSSION ON CONSENSUS CONCLUSIONS, UNRESOLVED CONCERNS AND
RECOMMENDATIONS FOR FOLLOW-UP ACTIONS

246

Moderator: Louis Ianniello (DOE)

Panelists: H. Kent Bowen (Massachusetts Institute of Technology)
Arthur F. McLean (Ford Motor Co.)
Maxine Savitz (DOE)
Victor J. Tennery (Oak Ridge National Laboratory)
Rao R. Tummala (International Business Machines Corp.)
David G. Wirth, Jr. (Coors Porcelain Co.)

Alphabetic Directory of Attendees

249

INTRODUCTION

This Contractors Meeting on Problems and Opportunities in Structural Ceramics was sponsored by the Energy Materials Coordinating Committee. It was held on 29-30 September 1982 at DOE Headquarters in Germantown, Maryland.

The meeting had two objectives: The promotion of inter-programmatic coordination and the identification of problems and opportunities in structural ceramics.

The Energy Materials Coordinating Committee is an internal Department of Energy committee set up to assist in the coordination of materials research and development programs. It functions by sponsoring certain activities, such as this contractor coordination meeting, and preparing an annual report which contains information on the Department of Energy's programs in materials research and development. It has sponsored many contractor meetings on diverse subjects including protective coatings, superconductivity, standardized materials testing procedures, and a previous one on structural ceramics (Knoxville, June 1979).

The first part of the program consisted of presentations concerning cognizant DOE programs on structural ceramics, and related work now underway under the Department of Defense and NASA, and in Germany and Japan. This was followed by some information concerning the DOE Collaborative Research Centers and unique capabilities at several DOE Laboratories that are highly relevant to the interests of the structural ceramics community. The balance of this report is derived from four panel discussions. Their titles, which are self-descriptive, are "New Directions for Fabrication Reliability," "Civilian Market Analysis for Structural Ceramics," "Domestic Ceramic Producers and Engine Manufacturers," and "Consensus Conclusions, Unresolved Concerns and Recommendations for Follow-up Actions."

In addition to the specific technical recommendations, the following general observations were made:

Virtually every DOE technology program would benefit from improved high temperature structural ceramics. Higher temperature performance in energy conversion translates directly into energy conservation, and often to reduced environmental impact as well. Attendees were well aware of this, and many were involved in research related to more fuel efficient

engines: adiabatic Diesel, Stirling engine, ceramic recuperators, etc. But in addition to these obvious applications, there is a wide range of energy devices in which one or more of the characteristic properties of ceramics will be needed, e.g., first walls and limiters for fusion reactors; photothermal absorbers with tailored absorption for solar energy; very high temperature heat exchangers; erosion and corrosion resistant valves and piping for coal conversion; and large turbines for direct combustion power generation.

For most of the above, the inherent properties of ceramics are essential for optimum performance. But in addition, ceramics have other properties that make them even more desirable. The raw materials from which they are made are cheap, and moreover, are readily available domestically. Ceramic components have a high strength-to-weight ratio and are resistant to erosion. Thus, for many applications, they are promising substitutes for alloys based on strategic materials. With improvements in fracture toughness, ceramics would greatly reduce our national need for reliable sources of strategic materials.

The attendees considered the development of predictable, reliable engineering ceramics to be the most important current question. Much of the meeting consisted of panel discussions, audience participation and follow-on questions related to this general topic. The enthusiasm of the audience was apparent, and the frank and open discussions contributed greatly to the success of the meeting.

A second high priority topic was the transfer of ceramics technology from the laboratory to the manufacturing industry. DOE, a mission agency, must manage its programs in a manner consistent with its mission. Energy is almost entirely in the domain of the private sector. It is therefore imperative that the DOE research and development activities be closely coordinated with those of industry, for it is they who must develop, manufacture and market the ultimate energy products.

It is also clear that the contributions of improved structural ceramics will go far beyond those made to energy. Many of the issues related to quality and performance are critical for all uses, not just those related to energy. The overall goals we seek will be attained only if there is maximum involvement by all parties -- the Department of Energy, its contractors, government agencies other than the DOE and their contractors, plus those in private industry, working on R&D, on production, or both. The participation of all in the dialogue of this meeting is essential.

The participants in this forum exchanged information and ideas concerning problems, opportunities and capabilities, especially in some areas where meaningful collaboration would be useful. These included some possibilities for collaborative research, temporary personnel exchanges, sharing of unique or special capabilities, information feed-back between groups, professions,

and organizations. I urge you to follow-up on these many constructive ideas. You also need to have a continuing forum for the dialogue you initiated here. We will assist in catalyzing this dialogue so long as it is necessary. It is a matter of critical concern to our society that we get our act together and make the most effective integrated usage of the enormous domestic resources represented by the participants in this meeting.

Dr. James S. Kane
Deputy Director
Office of Energy Research
U.S. Department of Energy
Washington, DC 20585

DOE COMBUSTION ZONE DURABILITY PROGRAM

JOHN W. FAIRBANKS, DOE

OFFICE OF FOSSIL ENERGY

ASSISTANT SECRETARY
FOSSIL ENERGY
JAN W. MARES

DEPUTY ASSISTANT
SECRETARY
DONALD L. BAUER

OFFICE OF MANAGEMENT
PLANNING AND TECHNICAL
COORDINATION

DIRECTOR—J. WALSH
DEPUTY—D. JEWETT*

OFFICE OF COAL
UTILIZATION, ADVANCED
CONVERSION AND GASIFICATION

DIRECTOR—R. HARRINGTON
DEPUTY—R. HARRINGTON (ACTG)

OFFICE OF OIL, GAS,
SHALE AND COAL
LIQUIDS

DIRECTOR—K. FRYE (ACTG)
DEPUTY PROGRAMS—K. FRYE
DEPUTY TECHNOLOGY—P. PETZICK

DIVISION OF
RESOURCE
MANAGEMENT

DIRECTOR—D. JEWETT*

DIVISION OF
PLANNING AND
ENVIRONMENT

DIRECTOR—D. BEECY

DIVISION OF
TECHNICAL
COORDINATION

VACANT

DIVISION OF
ADVANCED
CONVERSION SYSTEMS

DIRECTOR—
R. HARRINGTON (ACTG)

DIVISION OF COAL
UTILIZATION SYSTEMS

DIRECTOR—H. FEBUS

DIVISION OF
SURFACE COAL
GASIFICATION

DIRECTOR—
R. HARRINGTON (ACTG)

DIVISION OF OIL,
GAS AND SHALE
TECHNOLOGY

DIRECTOR—K. FRYE
(ACTG)

DIVISION OF COAL
LIQUEFACTION
TECHNOLOGY

DIRECTOR—
J. BATCHELOR

DIVISION OF
SPECIAL PROJECTS

DIRECTOR—
E. LEVENS

COAL PREPARATION
AND ANALYSIS
LABORATORY

PITTSBURGH
MINING TECHNOLOGY
CENTER

GRAND FORKS
ENERGY TECHNOLOGY
CENTER

MORGANTOWN
ENERGY TECHNOLOGY
CENTER

PITTSBURGH
ENERGY TECHNOLOGY
CENTER

BARTLESVILLE
ENERGY TECHNOLOGY
CENTER

LARAMIE
ENERGY TECHNOLOGY
CENTER

5

*DUAL POSITION

APPROVED JUNE 26, 1982

COMBUSTION ZONE DURABILITY

PROGRAM GOAL -

**ENSURE OR ENABLE GAS TURBINE AND DIESEL ENGINES CAPABLE OF OPERATING
ON ALTERNATIVE FUELS IN:**

EFFICIENT,

DURABLE,

ENVIRONMENTALLY ACCEPTABLE MANNER

EMPHASIS - BENEFICIATED COAL FUELS



**COMBUSTION ZONE DURABILITY STEERING PANEL
DIRECTLY FIRED HEAT ENGINE APPLICATIONS**

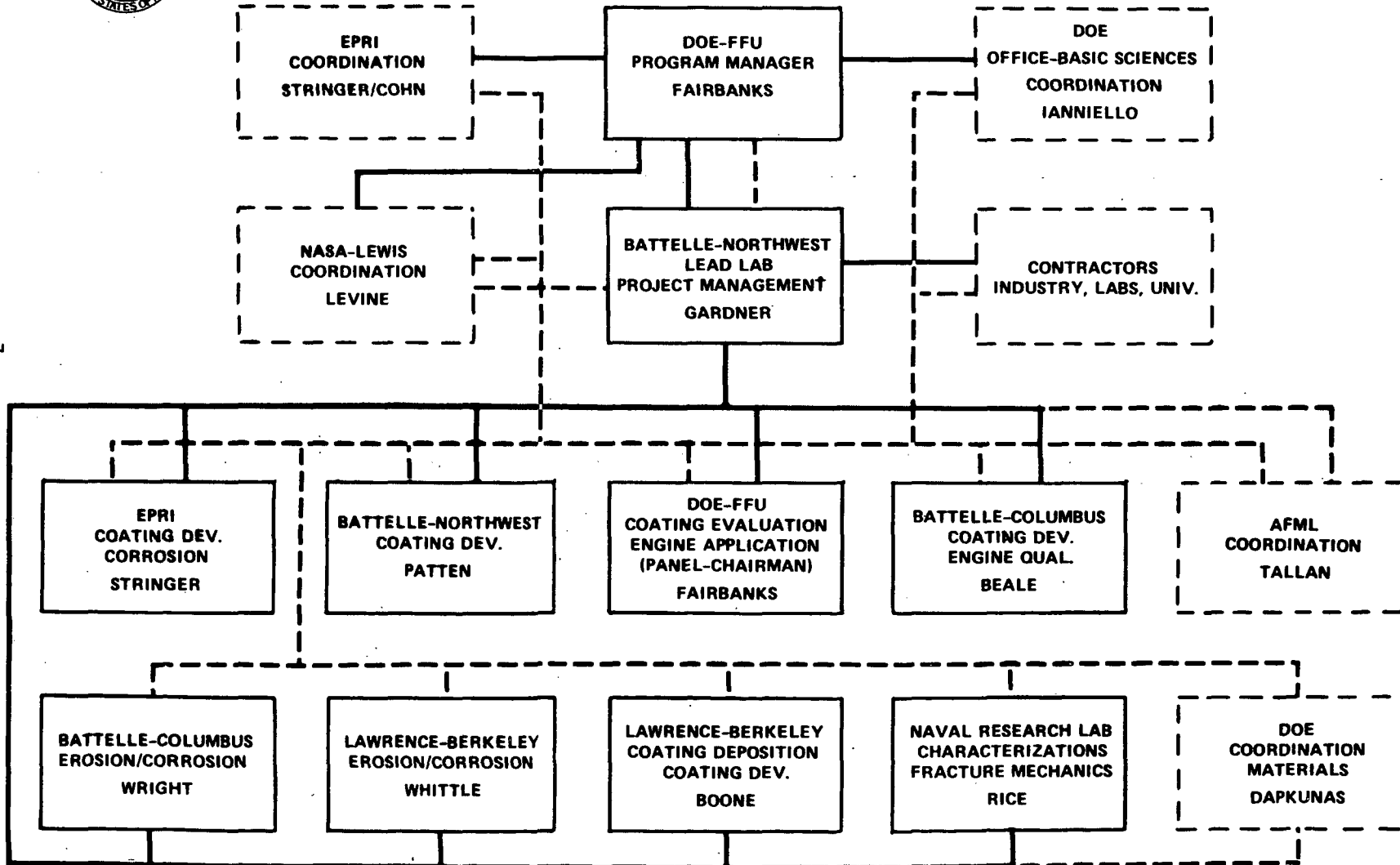

PROBLEMS

GAS TURBINE

- o **EROSION/CORROSION**
- o **THERMAL**

DIESEL

- o **EROSION**
- o **COMBUSTION CHAMBER INSULATION**

BOTH

- o **FUEL HANDLING AND INTRODUCTION INTO ENGINE**

**ACCELERATED ATTACK OF IN738 CAUSED BY COMBINED HOT
CORROSION AND EROSION
(DATA FROM EPRI PROGRAM RP543-1 PERFORMED BY
UNITED TECHNOLOGIES)**

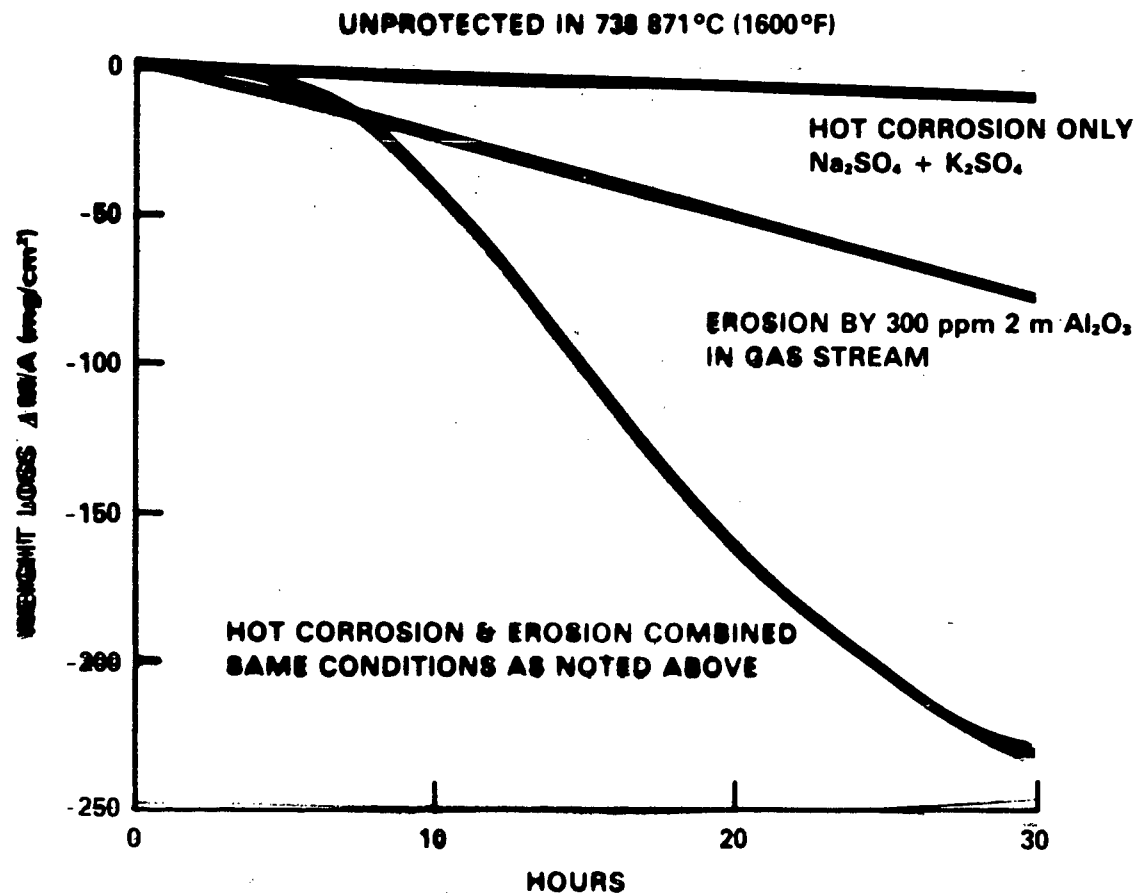

TURBINE ALLOY TRENDS

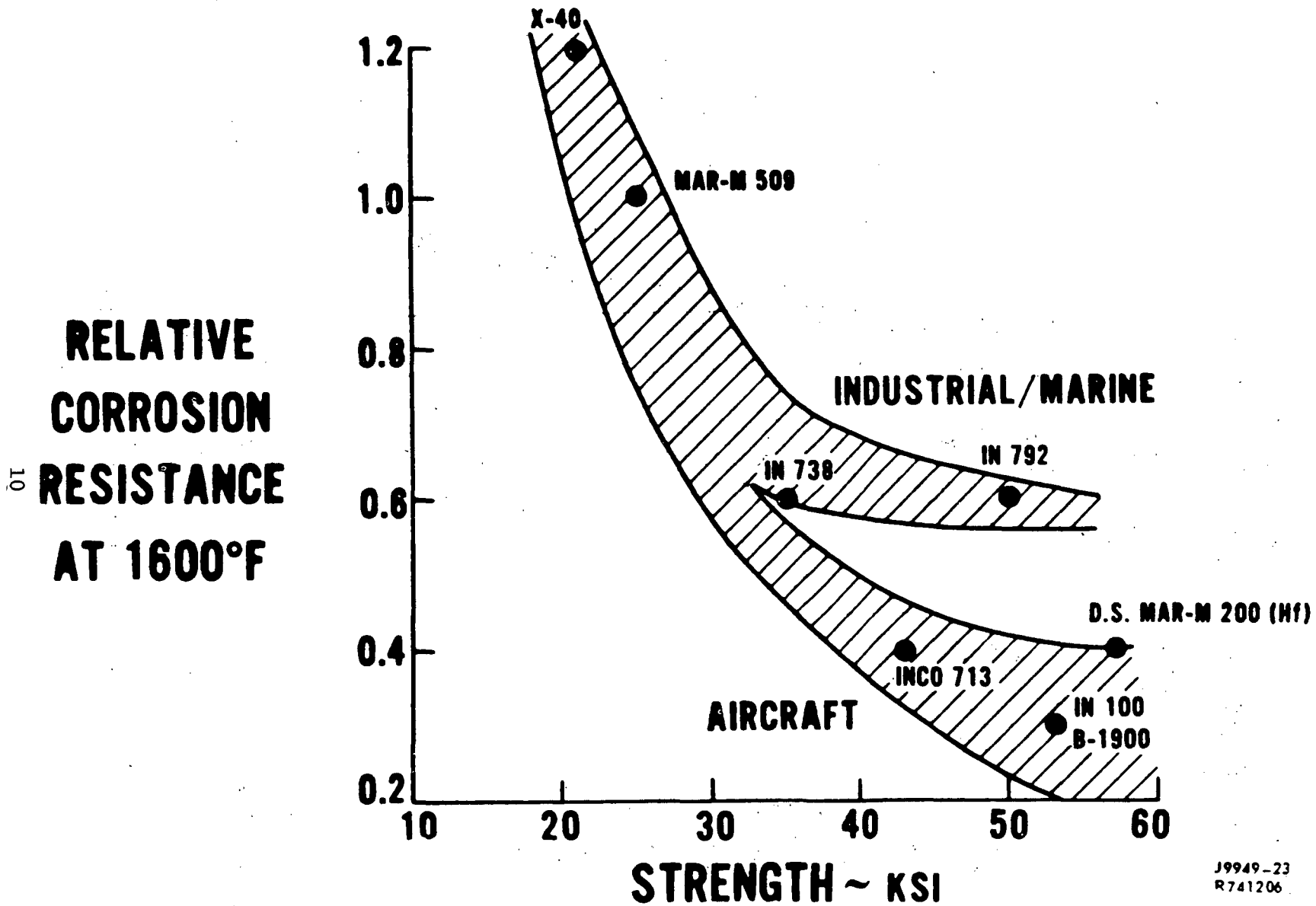

TRENDS IN TURBINE AIRFOIL MATERIALS

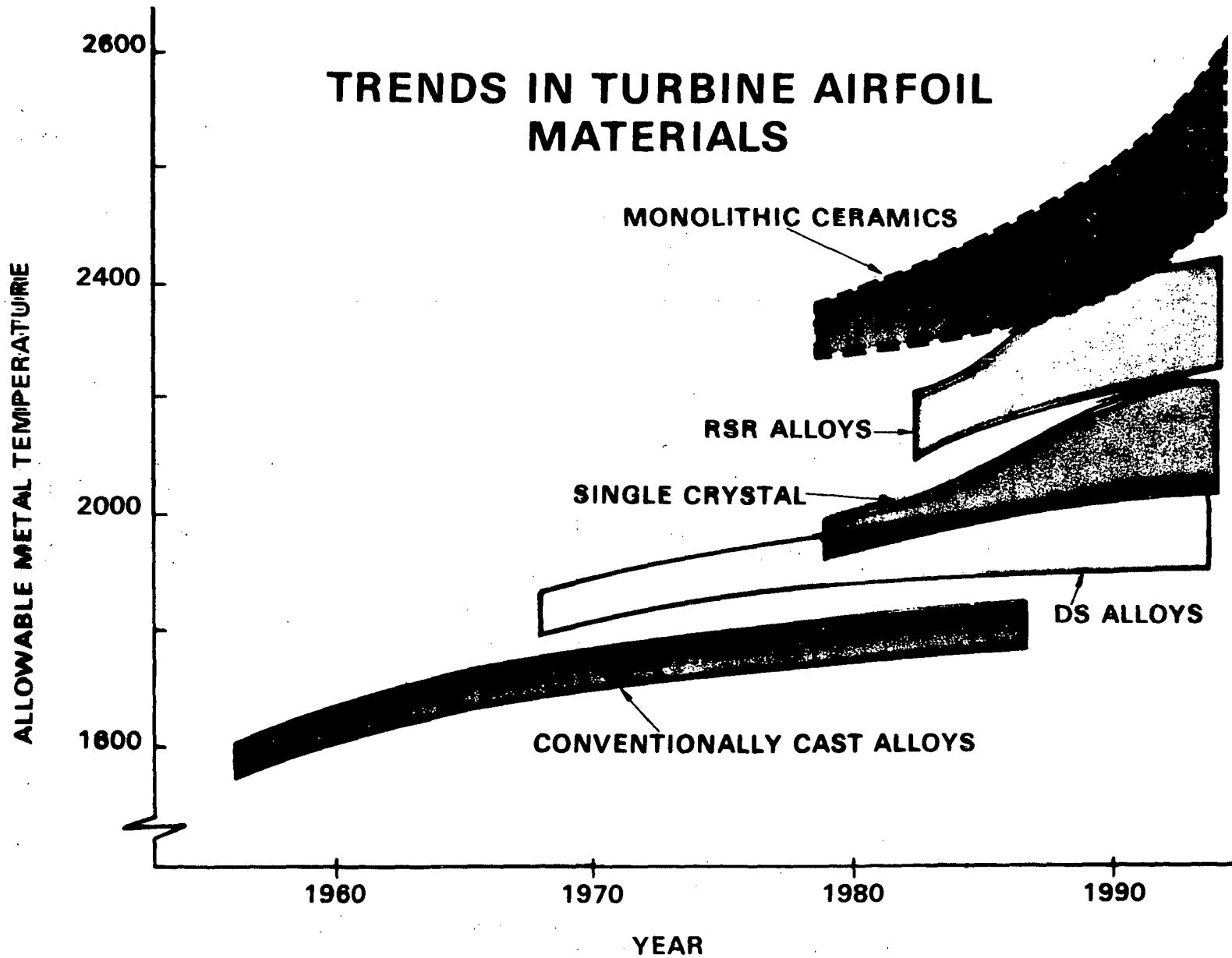

RICH-LEAN COMBUSTOR WITH VENTURI QUENCH

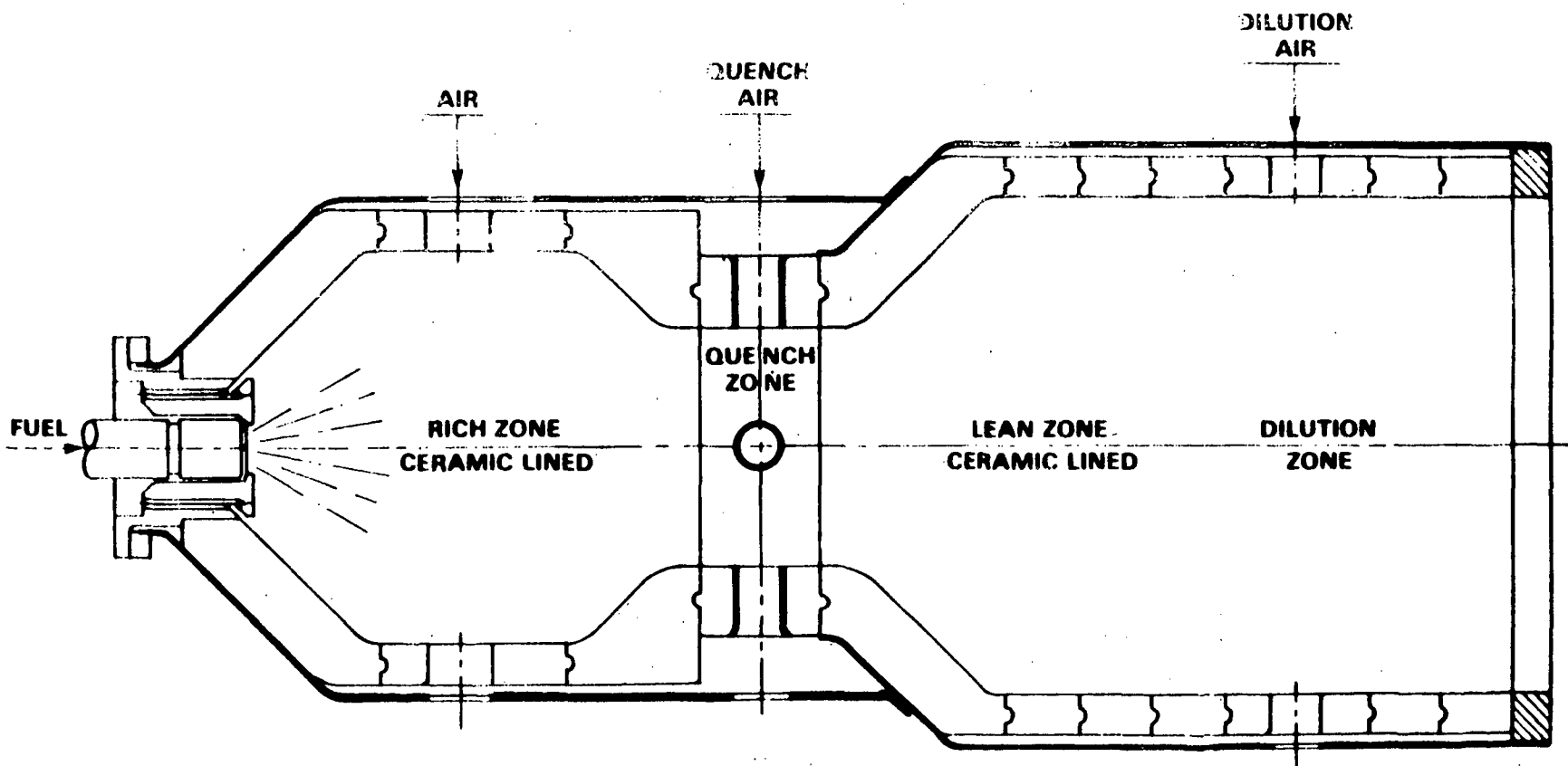

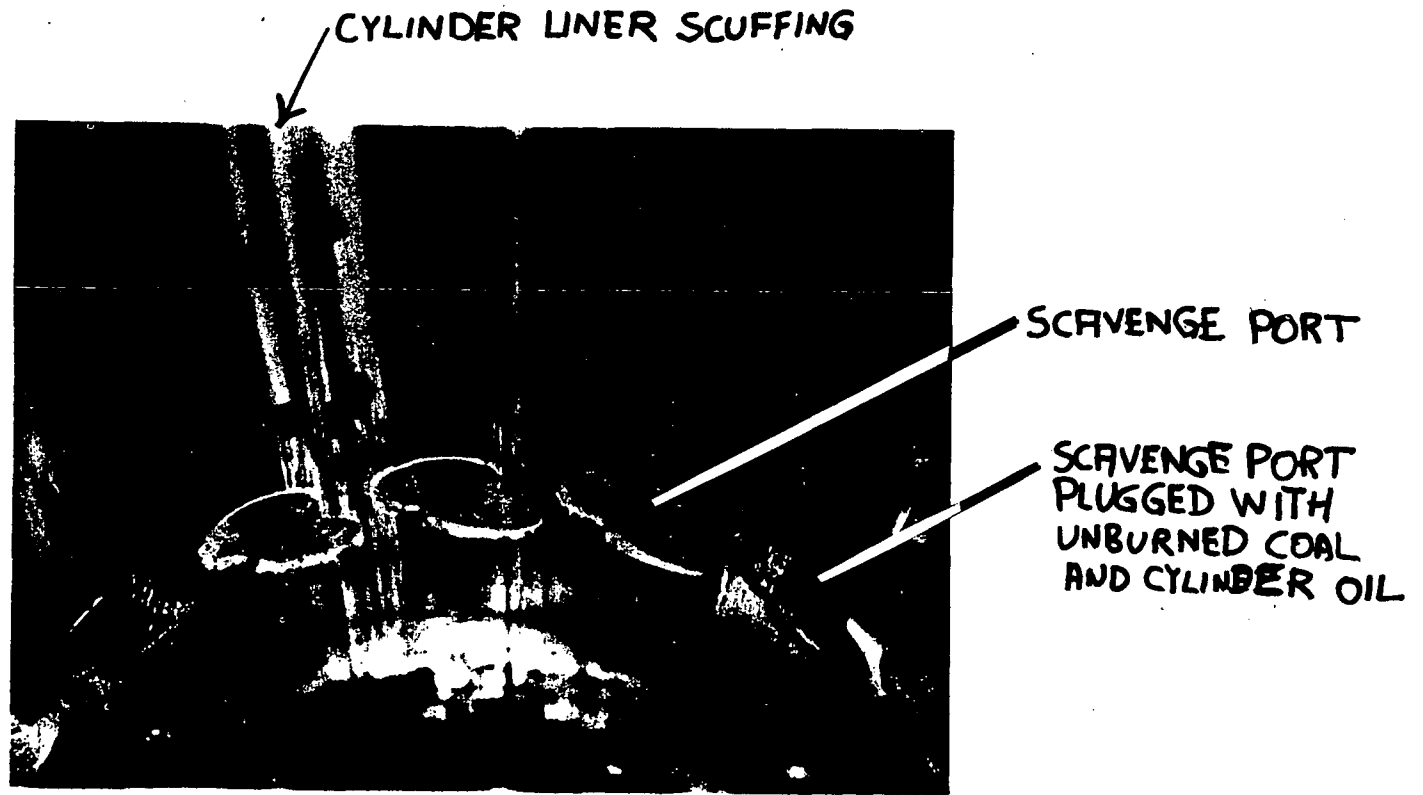

CONDITIONS:
CONSTANT LOAD 100%
CONSTANT RPM 150
CONSTANT SCAVENGING
PRESSURE 1.80 BAR
SAME INJECTION TIMING

LINER PORTS
FUEL: COAL SLURRY
AFTER TEST 1 HOURS
SXH E 2320

APPROACH

- o **DEVELOP CERAMIC COATINGS WHICH MAINTAIN ADHERENCE AND STRUCTURAL INTEGRITY**
 - o **IMPERMEABLE TO CORROSION CONDENSATES**
 - o **DENSE FOR EROSION RESISTANCE**
 - o **REPRODUCIBLE PROPERTIES**
- o **TEST AND EVALUATE IN ITERATIVE MANNER**
- o **ENGINE TEST APPROPRIATE CANDIDATES**
- o **CO-EVOLVE COAL FUEL DEVELOPMENT WITH ENGINE MODIFICATIONS**
- o **USE GAS TURBINE MATERIALS TECHNOLOGY BASE FOR DIESEL ENGINE**

ADVANTAGES OF CERAMIC/ THERMAL BARRIER COATINGS

- **COMPATIBLE WIDE RANGE OF FUELS**
- **IMPROVED HOT-SECTION DURABILITY**
 - **ENHANCED HOT-CORROSION RESISTANCE**
 - **MORE TOLERANT OF EROSION**
 - **REDUCED HOT-STREAKING EFFECTS**
- **SIGNIFICANTLY IMPROVED EFFICIENCY**
 - **REDUCED COOLING AIR**
 - **HIGHER TURBINE INLET TEMPERATURES**
- **REDUCED USE CRITICAL MATERIALS**
- **GROWTH CAPABILITY >3,000°F**



Section through NASA ZrO_2 -12% Y_2O_3 -coated IN 738 pin after 150 hour exposure to a Na_2SO_4 -1% $PbSO_4$ melt at $900^\circ C$. Salt composition corresponds to that expected from the combustion of a fuel containing 10 ppm Na, 5 ppm Pb, 1% S with air/fuel = 50/1, 5 atm. total pressure. x150

COATING LIFE IN INDUSTRIAL/UTILITY GAS TURBINES

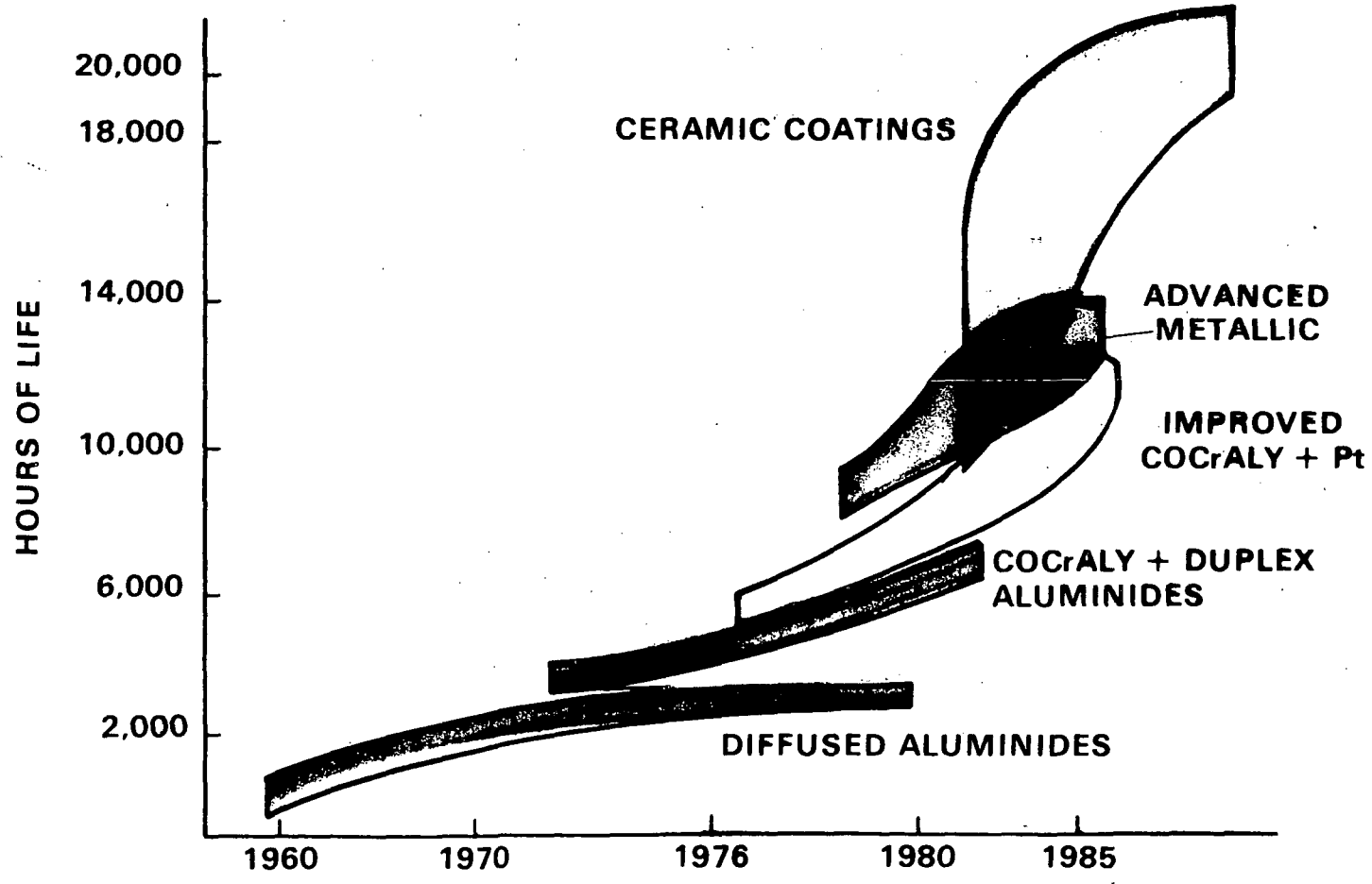

ADIABATIC DIESEL

- o THERMALLY INSULATED COMBUSTION CHAMBER
- o DEMONSTRATED LOW CETANE NO. (16) OPERATION
- o INCREASED TEMPERATURE OF COMBUSTION
 - o LARGER SIZE COAL PARTICLES
 - o REDUCED EMISSIONS, HYDROCARBONS, PARTICULATES - 50 PERCENT
- o EFFICIENCY IMPROVEMENT
 - o 37 PERCENT DEMONSTRATED WITH NO. 2 DIESEL
 - o BETTER SEALING
 - o COMPLETE COMBUSTION
 - o BETTER WASTE HEAT UTILIZATION

FUELS

ADIABATIC ENGINE

DIESEL ENGINE

PROCESSING

PRECOMBUSTION CHAMBER

**BLEND
W/NO. 2**

SPARK ASSISTED

**BLEND
W/BIOMASS**

**ELECTRONIC FUEL
CONTROL**

FUMIGATION

**REDUCE CETANE
SENSITIVITY
COAL & SHALE DERIVED
FUELS**

**PILOT
INJECTION**

FUEL PREHEAT

**NAHBE
CONCEPT**

ADDITIVES

**REDUCE
SPEED**

HEAT ENGINES CONTRACT SYNOPSIS

June 24, 1982

Program: Combustion Zone Durability

Contractor: Cummins Engine Co.

Contracting Agency: DOE San Francisco Office

Contract Value: \$ 270 K Contract Period: from 2/80 thru 10/82

Title: Utilization of SRC-2 Fuel in Insulated Diesel Engine

Description of Tasks: Investigate the multifuel advantages and effect on
emissions of the adiabatic diesel with coal derived liquid fuels. Compara-
tive data established with conventional and uncooled engine. Also, candidate
ceramic material from combustion zone durability program included for
engine assessment

Key Contacts:	<u>Contractor</u>	<u>Contracting Agency</u>
Name	<u>Roy Kamo</u>	<u>U.S. Department of Energy</u>
Address	<u>Cummins Engine Co.</u>	<u>San Francisco Operations Office</u>
	<u>P.O. Box 3005</u>	<u>1333 Broadway</u>
	<u>Columbus, IN 47201</u>	<u>Oakland, CA 94612</u>
Telephone	<u>(812) 379-5591 (comm)</u>	<u>ATTN: Cheryl Boutte</u>
	<u>(8) (FTS)</u>	<u>(415) 273-7946 (comm)</u>
		<u>(8) 536-7946 (FTS)</u>
Hq Program Manager:	<u>John Fairbanks</u> ;	<u>(8) 233-5463 (FTS)</u>

HEAT ENGINES CONTRACT SYNOPSIS

June 24, 1982

Program: Combustion Zone Durability Program

Contractor: Cummins Engine Co.

Contracting Agency: Battelle-Pacific Northwest Laboratories

Contract Value: \$ 90 K Contract Period: from 6/82 thru 4/83

Title: Insulated/Wear Resistant Materials for the Adiabatic Diesel

Description of Tasks: Investigate the use of ZrO₂ densified with CrO₂ or other oxides for application in the adiabatic diesel. This class of materials has the potential for providing erosion/corrosion resistance as well as an insulated combustion chamber which will enhance the diesel engines ability to operate on coal base fuels, particularly coal water slurries.

Key Contacts:	<u>Contractor</u>	<u>Contracting Agency</u>
Name	<u>Roy Kamo</u>	<u>Darrell Hays</u>
Address	<u>Cummins Engine Co.</u> <u>P.O. Box 3005</u> <u>Columbus, IN 47201</u>	<u>Battelle-Pacific Northwest Lab</u> <u>P.O. Box 999</u> <u>Richland, WA 99352</u>
Telephone	<u>(812) 379-7206 (comm)</u> <u>(8) (FTS)</u>	<u>(509) 942-2829 (comm)</u> <u>(8) 440-2829 (FTS)</u>
Hq Program Manager:	<u>John Fairbanks</u> ;	<u>(8) 233-5463 (FTS)</u>

HEAT ENGINES CONTRACT SYNOPSIS

June 24, 1982

Program: Combustion Zone Durability Program

Contractor: Cummins Engine Co.

Contracting Agency: Battelle-Pacific Northwest Laboratories

Contract Value: \$ 73 K Contract Period: from 3/11/81 thru 7/82

Title: Modified Diesel Engine Combustion Systems for Coal Derived
Liquid Fuel Operation

Description of Tasks: Investigate the feasibility of precombustion chamber
and spark assist with coal base fuels and mated to the adiabatic diesel.
Emphasis is on materials requirements, specifically ceramics, for
precombustion chamber design.

Key Contacts:

Contractor

Contracting Agency

Name Roy Kamo

Darrell Hays

Address Cummins Engine Co.

Battelle-Pacific Northwest Lab

P.O. Box 3005

P.O. Box 999

Columbus, IN 47201

Richland, WA 99352

Telephone (812) 379-5977 (comm)

(509) 942-2829 (comm)

(8) (FTS)

(8) 440-2829 (FTS)

Hq Program Manager: John Fairbanks ;

(8) 233-5463 (FTS)

HEAT ENGINES CONTRACT SYNOPSIS

June 24, 1982

Program: Combustion Zone Durability Program

Contractor: Lawrence Berkeley Laboratory

Contracting Agency: Battelle-Pacific Northwest Lab

Contract Value: \$ 150 K Contract Period: from 9/30/81 thru 10/1/82

Title: Coordinate test and evaluation of candidate materials for
heat engine durability on coal base fuel operation.

Description of Tasks: Analyze specimens obtained from supporting combustion
test programs (burner rig, engines) to determine materials degradation mechanisms
for selected combinations of combustion parameters, fuel chemistry and test
materials in order to build a sound base for predicting combustion zone durability
of a wide range of materials exposed to advanced alternative fuels - conduct
tribological studies of systems at engine temperatures.

Key Contacts:	<u>Contractor</u>	<u>Contracting Agency</u>
Name	<u>Don Boone</u>	<u>Darrel Hays</u>
Address	<u>Lawrence Berkeley</u> <u>University of California</u> <u>Berkeley, CA 94720</u>	<u>Battelle - PNL</u> <u>P. O. Box 999</u> <u>Richland, WA 99352</u>
Telephone	<u>(415) 486-4914 (comm)</u> <u>(8) 451-4914 (FTS)</u>	<u>(509) 942-2829 (comm)</u> <u>(8) 440-2829 (FTS)</u>
Hq Program Manager:	<u>John Fairbanks</u> ;	<u>(8) 233-5463 (FTS)</u>

HEAT ENGINES CONTRACT SYNOPSIS

June 24, 1982

Program: Combustion Zone Durability Program

Contractor: United Technologies Research Center

Contracting Agency: Battelle-Pacific Northwest Laboratories

Contract Value: \$ 90 K Contract Period: from 6/82 thru 8/83

Title: Diesel Engine Application of Glass Matrix Composites

Description of Tasks: Develop SiC reinforced glass matrix ceramic materials for diesel engine cylinder liner. Material characteristics of this new type of material to determine dimensional stability, fracture toughness, wear resistance, friction, thermal conductivity, and creep. Iterative design is involved with the weave pattern, glass impregnation and liner design requirements.

Key Contacts:

Contractor

Contracting Agency

Name	<u>Karl Prewo</u>	<u>Darrell Hays</u>
Address	<u>United Technologies Research Center</u>	<u>Battelle-Pacific Northwest Lab 200-W P.O. Box 999 (231-Z Bldg; Area</u>
	<u>East Hartford, CT 06108</u>	<u>Richland, WA 99352</u>
Telephone	<u>(203) 727-7237 (comm)</u>	<u>(509) 942-2829 (comm)</u>
	<u>(8) (FTS)</u>	<u>(8) 440-2829 (FTS)</u>

Hq Program Manager: John Fairbanks ; (8) 233-5463 (FTS)

HEAT ENGINES CONTRACT SYNOPSIS

June 24, 1982

Program: Combustion Zone Durability Program

Contractor: Pratt & Whitney

Contracting Agency: Battelle-Pacific Northwest Laboratories

Contract Value: \$ 207 K Contract Period: from 10/80 thru 10/82

Title: Development of Advanced Plasma Sprayed Ceramic Coatings for
Industrial Gas Turbine Engines

Description of Tasks: Develop durable ceramic coatings for near-term use in
industrial/utility gas turbine hot-sections, primarily airfoils to improve
hot-corrosion and erosion resistance and achieve advantages of thermal
insulation. The major improvement in coating adherence is being obtained
with microcrack toughening and/or segmentation of the ceramic layer.

Key Contacts:	<u>Contractor</u>	<u>Contracting Agency</u>
Name	<u>Scott Duvall</u>	<u>Darrell Hays</u>
Address	<u>Pratt & Whitney</u> <u>400 East Main St.</u> <u>East Hartford, CT</u>	<u>Battelle-Pacific Northwest Lab</u> <u>P.O. Box 999</u> <u>Richland, WA 99352</u>
Telephone	<u>(203) 565-7775 (comm)</u> <u>(8) (FTS)</u>	<u>(509) 942-2829 (comm)</u> <u>(8) 440-2829 (FTS)</u>
Hq Program Manager:	<u>John Fairbanks</u> ;	<u>(8) 233-5463 (FTS)</u>

HEAT ENGINES CONTRACT SYNOPSIS

June 24, 1982

Program: Combustion Zone Durability Program

Contractor: San Fernando Labs

Contracting Agency: Battelle-Pacific Northwest Laboratories

Contract Value: \$ 179 K Contract Period: from 10/80 thru 9/82

Title: Controlled Nucleation Thermochemical Deposition (CNTD) of
SiC Overcoat to Thermal Barrier Coatings

Description of Tasks: Developing CNTD SiC for sealing layers on
segmented or porous thermal barrier coating to prevent penetration of
condensates from poor quality fuels. Also, developing W and W/C coatings for
improved wear resistance in fuel injectors operating with coal base fuels
working from 75% to fully dense ZrO₂, stabilizers Y₂O₃, MgO and CaO to vary
thermal expansion 6×10^{-6} to $10 \times 10^{-6}/^{\circ}\text{C}$.

Key Contacts:	<u>Contractor</u>	<u>Contracting Agency</u>
Name	<u>Jack Stiglich</u>	<u>Darrell Hays</u>
Address	<u>San Fernando Lab</u> <u>10258 North Ave.</u> <u>Pacoima, CA 91331</u>	<u>Battelle-Pacific Northwest Lab</u> <u>200-W</u> <u>P.O. Box 999 (231-Z Bldg; Area</u> <u>Richland, WA 99352</u>
Telephone	<u>(213) 899-7484 (comm)</u> <u>(8) (FTS)</u>	<u>(509) 942-2829 (comm)</u> <u>(8) 440-2829 (FTS)</u>
Hq Program Manager:	<u>John Fairbanks</u> ;	<u>(8) 233-5463 (FTS)</u>

HEAT ENGINES CONTRACT SYNOPSIS

June 24, 1982

Program: Combustion Zone Durability Program

Contractor: National Bureau of Standards

Contracting Agency: DOE/HQ

Contract Value: \$ 95 K Contract Period: from 1/1/82 thru 9/30/82

Title: NBS Interagency Agreement - Characterization of Structural Ceramics for Diesel Engines (Extension of Work Scope Task Order A086(PS) Within Terms of Memo of Understanding Between NBS and DOE 9/16/75)

Description of Tasks: Investigate the long term effects of high temperature on strength of silicon based ceramics and selected oxide ceramics which are candidate materials for adiabatic diesel engines. Also, characterize the strength controlling structural changes that occur during high temperature exposure tests. In addition, determine temperature conditions that limit the applicability of proof testing as a method of providing the necessary reliability of ceramics in diesels.

Key Contacts:

Contractor

Contracting Agency

Name Dr. Sheldon Weiderhorn

Judi Willis

Address National Bureau of Standards

DOE/HQ

Building No. 101, Room 87

Office of Procurement Operations

Washington, D.C. 20234

Washington, D.C.

Telephone (301) 921-2901 (comm)

(202) 252-1550 (comm)

(8) (FTS)

(8) (FTS)

Hq Program Manager: John Fairbanks ;

(8) 233-5463 (FTS)

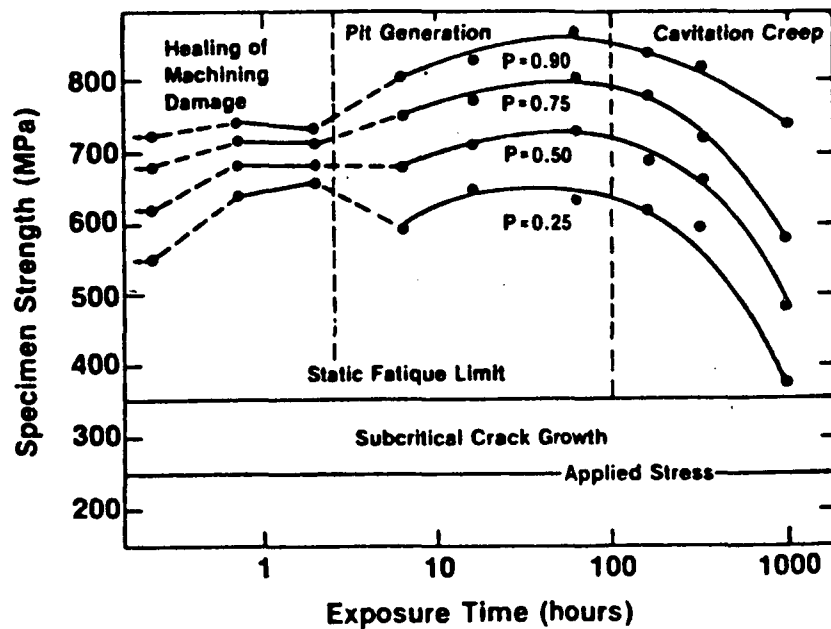

Deformation map constructed from strength distribution data obtained for billet C specimens that survived static load test at 1200 °C, with a load of 250 MPa.

HEAT ENGINES CONTRACT SYNOPSIS

June 24, 1982

Program: Combustion Zone Durability

Contractor: Central Institute for Industrial Research

Contracting Agency: Battelle-Pacific Northwest Laboratories

Contract Value: \$ 50 K Contract Period: from 10/81 thru 9/82

Title: Develop and Engine Test Ceramic Coatings on Diesel Engine Parts

Description of Tasks: Ceramic coatings of the type being developed and tested in slow-speed and medium-speed diesel engines in marine propulsion operating on residual fuels are prepared for United States lab and engine test & evaluation. U. S. coatings are provided for Norwegian lab testing. Coatings in this program have more than 2 X life of diesel exhaust valves and piston crowns.

Key Contacts:	<u>Contractor</u>	<u>Contracting Agency</u>
Name	<u>Dr. Ingard Kvernes</u>	<u>Darrell Hays</u>
Address	<u>Central Inst. for Ind. Res.</u> <u>Forskningsv, 1</u> <u>Oslo 3, Norway</u>	<u>Battelle-Pacific Northwest Labs</u> <u>P.O. Box 999</u> <u>Richland, WA 99352</u>
Telephone	<u>(02) 69-58-80 (comm)</u> <u>(8) (FTS)</u>	<u>(509) 942-2829 (comm)</u> <u>(8) 440-2829 (FTS)</u>
Hq Program Manager:	<u>John Fairbanks</u> ;	<u>(8) 233-5463 (FTS)</u>

HEAT ENGINES CONTRACT SYNOPSIS

June 24, 1982

Program: Combustion Zone Durability

Contractor: Laystall Engineering Ltd

Contracting Agency: Battelle-Pacific Northwest Laboratories

Contract Value: \$ 19K Contract Period: from 1/82 thru 3/82

Title: Silicon Carbide Impregnation of Diesel Engine Components

Description of Tasks: Laystall Engineering developed an erosion resistant SiC impregnation that very significantly improves wear resistance of cylinder liners in British Chieftan battle tanks. Four sets of cylinder liners & rings for Transamerica Delaval engine testing and specimens for laboratory analysis with respect to coal-derived fuels are being obtained.

Key Contacts:	<u>Contractor</u>	<u>Contracting Agency</u>
Name	<u>Jack Tanner</u>	<u>Darrell Hays</u>
Address	<u>Laystall Engineering Ltd</u> <u>10 Dixon St.</u> <u>Wolverhampton, WVZ 2BU, UK</u>	<u>Battelle-Pacific Northwest Labs</u> <u>P.O. Box 999</u> <u>Richland, WA 99352</u>
Telephone	<u>(011)44-902-51789(comm)</u> <u>(8) (FTS)</u>	<u>(509) 942-2829 (comm)</u> <u>(8) 440-2829 (FTS)</u>
Hq Program Manager:	<u>John Fairbanks</u> ;	<u>(8) 233-5463 (FTS)</u>

HEAT ENGINES CONTRACT SYNOPSIS

June 24, 1982

Program: Combustion Zone Durability

Contractor: Transamerica Delaval

Contracting Agency: Battelle-Pacific Northwest Laboratories

Contract Value: \$30 K Contract Period: from 1/81 thru 10/83
(Delaval cost sharing = 60K)

Title: Testing of SiC Impregnated Diesel Engine Cylinder Liners

Description of Tasks: Investigate the potential increase in erosion resistance of large industrial/utility diesel engines by SiC particle impregnation. This approach improved wear resistance in L-60 diesel engines in Chieftan tanks from 250 hours to over 4000 hours. SiC impregnated liners may provide wear resistance with coal fuels without requiring extensive beneficiation of the coals. Liners are tested in lab engine and at an industrial site on residual fuel, then on MV Gott

Key Contacts:	<u>Contractor</u>	<u>Contracting Agency</u>
Name	<u>Al. Fleishar</u>	<u>Darrell Hays</u>
Address	<u>Transamerica Delaval</u> <u>550 85th Ave.</u> <u>Oakland, CA 94621</u>	<u>Battelle-Pacific Northwest Labs</u> <u>P.O. Box 999</u> <u>Richland, WA 99352</u>
Telephone	<u>(415) 577-7400 (comm)</u> <u>(8) (FTS)</u>	<u>(509) 942-2829 (comm)</u> <u>(8) 440-2829 (FTS)</u>
Hq Program Manager:	<u>John Fairbanks</u> ;	<u>(8) 233-5463 (FTS)</u>

HEAT ENGINES CONTRACT SYNOPSIS

June 24, 1982

Program: Combustion Zone Durability Program

Contractor: Pratt & Whitney Aircraft WPB

Contracting Agency: Battelle-Pacific Northwest Laboratories

Contract Value: \$ 202 K Contract Period: from 9/28/79 thru 1/82

Title: Investigate Vanadium and Hot-Corrosion Resistance of
Cr-Si Base Coating System

Description of Tasks: Develop an improved metallic coating system based
on SiO₂ protective scale formation. The objective is to improve gas turbine
hot-section life operating on poor quality petroleum minimally processed coal
derived fuels, coal water slurries. Systematic variations of Ni-Cr-Si coating
systems are evaluated and compared with current coatings and Brown-Boveri's
Si coating system.

Key Contacts:	<u>Contractor</u>	<u>Contracting Agency</u>
Name	<u>Ralph Hecht</u>	<u>Darrell Hays</u>
Address	<u>Pratt & Whitney</u> <u>P.O. Box 2691</u> <u>West Palm Beach, FL 33402</u>	<u>Battelle-Pacific Northwest Lab</u> <u>200-</u> <u>P.O. Box 999 (231-Z Bldg; Area</u> <u>Richland, WA 99352</u>
Telephone	<u>(305) 840-5681 (comm)</u> <u>(8) (FTS)</u>	<u>(509) 942-2829 (comm)</u> <u>(8) 440-2829 (FTS)</u>
Hq Program Manager:	<u>John Fairbanks</u> ;	<u>(8) 233-5463 (FTS)</u>

HEAT ENGINES CONTRACT SYNOPSIS

June 24, 1982

Program: Combustion Zone Durability

Contractor: Pratt & Whitney

Contracting Agency: Battelle-Pacific Northwest Laboratories

Contract Value: \$ 250 K Contract Period: from 1/81 thru 12/82

Title: Advanced Vapor Deposited Ceramic Coatings for Industrial Gas Turbines

Description of Tasks: Columnar ceramic coatings deposited by electron-beam physical vapor deposition are being iteratively developed. Ceramic coatings of this type have exhibited 20 X greater resistance to thermal cycling than the best plasma spray deposited coatings. Reproducibility is the problem. Current work will identify the optimum process and ceramic structure characteristics.

Key Contacts:

Contractor

Contracting Agency

Name Scott Duvall

Darrell Hays

Address Pratt & Whitney

Battelle-Pacific Northwest Labs

400 Main St.

P.O. Box 999

East Hartford, CT

Richland, WA 99352

Telephone (203) 565-7363 (comm)

(509) 942-2829 (comm)

(8) (FTS)

(8) 440-2829 (FTS)

Hq Program Manager: John Fairbanks ;

(8) 233-5463 (FTS)

EB-PVD CERAMIC COATING
CYCLIC LIFE CAPABILITY

(2100°F TO AMBIENT)

CYCLIC
LIFE

7,000
6,000
5,000
4,000
3,000
2,000
1,000

BEST
PLASMA SPRAYED
COATING



BASELINE



EB-PVD

HEAT ENGINES CONTRACT SYNOPSIS

June 24, 1982

Program: Combustion Zone Durability

Contractor: Airco-Temescal

Contracting Agency: Battelle-Pacific Northwest Laboratories

Contract Value: \$ 125 K Contract Period: from 4/82 thru 4/83

Title: Electron-Beam Reactive Physical Vapor Deposition of Thermal Barrier Coatings

Description of Tasks: Develop computer-controlled electron-beam PVD to provide systematic parameter variation over a wide range of deposition conditions. Vary the parameters affecting adhaerence of sub-stoichiometric thermal barrier layers on α -Al₂O₃ forming metallic coatings. Samples will be thermally cycled tested and evaluated.

Key Contacts:

Contractor

Contracting Agency

Name Dr. Ernest Demaray

Darrell Hays

Address Airco-Temescal

Battelle-Pacific Northwest Labs

2850 Seventh St.

P.O. Box 999

Berkeley, CA 94710

Richland, WA 99352

Telephone (415) 841-5720 (comm)

(509) 942-2829 (comm)

(8) (FTS)

(8) 440-2829 (FTS)

Hq Program Manager: John Fairbanks

(8) 233-5463 (FTS)

HEAT ENGINES CONTRACT SYNOPSIS

June 24, 1982

Program: Combustion Zone Durability Program

Contractor: Naval Research Lab

Contracting Agency: Battelle-Pacific Northwest Laboratories

Contract Value: \$ 34 K Contract Period: from thru 10/30/82

Title: Laser Surface Treatment and Characterization of Ceramic Coatings

Description of Tasks: Determine if laser treatment can be used to seal,
i.e., glaze the surface of ZrO₂ coatings and improve coating microstructure
thru precipitate development. Also, investigate addition of fine additions
of ceramic particles to surface to increase coating density. Conduct basic
physical and mechanical characterization of candidate ceramic structures.
Determine which precipitates that give spectacular strength and toughness to
partially stabilized zirconia (PSZ) crystals may effect ZrO₂ coatings.

Key Contacts:	<u>Contractor</u>	<u>Contracting Agency</u>
Name	<u>Roy Rice</u>	<u>Darrell Hays</u>
Address	<u>Naval Research Lab</u>	<u>Battelle-Pacific Northwest Lab</u>
	<u>Code 6360</u>	<u>P.O. Box 999</u>
	<u>Washington, D.C. 20375</u>	<u>Richland, WA 99352</u>
Telephone	<u>(301) 767-2131 (comm)</u>	<u>(509) 942-2829 (comm)</u>
	<u>(8) (FTS)</u>	<u>(8) 440-2829 (FTS)</u>
Hq Program Manager:	<u>John Fairbanks</u> ;	<u>(8) 233-5463 (FTS)</u>

SOVIET PRODUCTION USE CERAMIC COATINGS

- COATING DIESEL TRUCK ENGINE PISTON (6") CROWN
 - 3 MIL MOLYBDEUM UNDERCOAT
 - 3 MIL ALUMINUM SILICATE

- IDENTIFIED AS CATALYST FOR
 - MORE COMPLETE BURNING OF FUEL
 - LESS RESIDUAL MATERIAL IN COMBUSTION CHAMBER
 - IMPROVED EFFICIENCY AND COLD WEATHER STARTING

ENERGY CONVERSION AND UTILIZATION TECHNOLOGIES
MATERIALS PROJECT - CERAMICS RESEARCH

JAMES J. EBERHARDT, DOE
AND
JOSEPH A. CARPENTER, ORNL

**OVERVIEW OF STRUCTURAL CERAMICS WORK IN THE
DOE ENERGY CONVERSION AND UTILIZATION TECHNOLOGIES (ECUT) PROGRAM**

Joseph A. Carpenter, Jr.

ORNL Manager of the ECUT Materials and Tribology Projects

EMACC CONTRACTORS MEETING ON STRUCTURAL CERAMICS

**DOE Headquarters
Germantown, Maryland**

SEPTEMBER 29, 1982

THE MISSION OF THE ENERGY CONVERSION AND UTILIZATION TECHNOLOGIES
(ECUT) PROGRAM IS TO CONDUCT GENERIC, LONG-TERM, HIGH-RISK
APPLIED RESEARCH AND EXPLORATORY DEVELOPMENT

- GOALS: EVALUATE NEW OR INNOVATIVE CONCEPTS FOR IMPROVED
EFFICIENCY OR ALTERNATE FUEL USE IN ENERGY CONVERSION
AND UTILIZATION EQUIPMENT

EXPAND THE TECHNOLOGY BASE NECESSARY FOR DEVELOPMENT
OF IMPROVED ENERGY CONVERSION AND UTILIZATION
EQUIPMENT BY THE PRIVATE SECTOR

ORGANIZATION CHART OF THE DOE OFFICE OF THE DEPUTY ASSISTANT SECRETARY FOR CONSERVATION AND RENEWABLE ENERGY

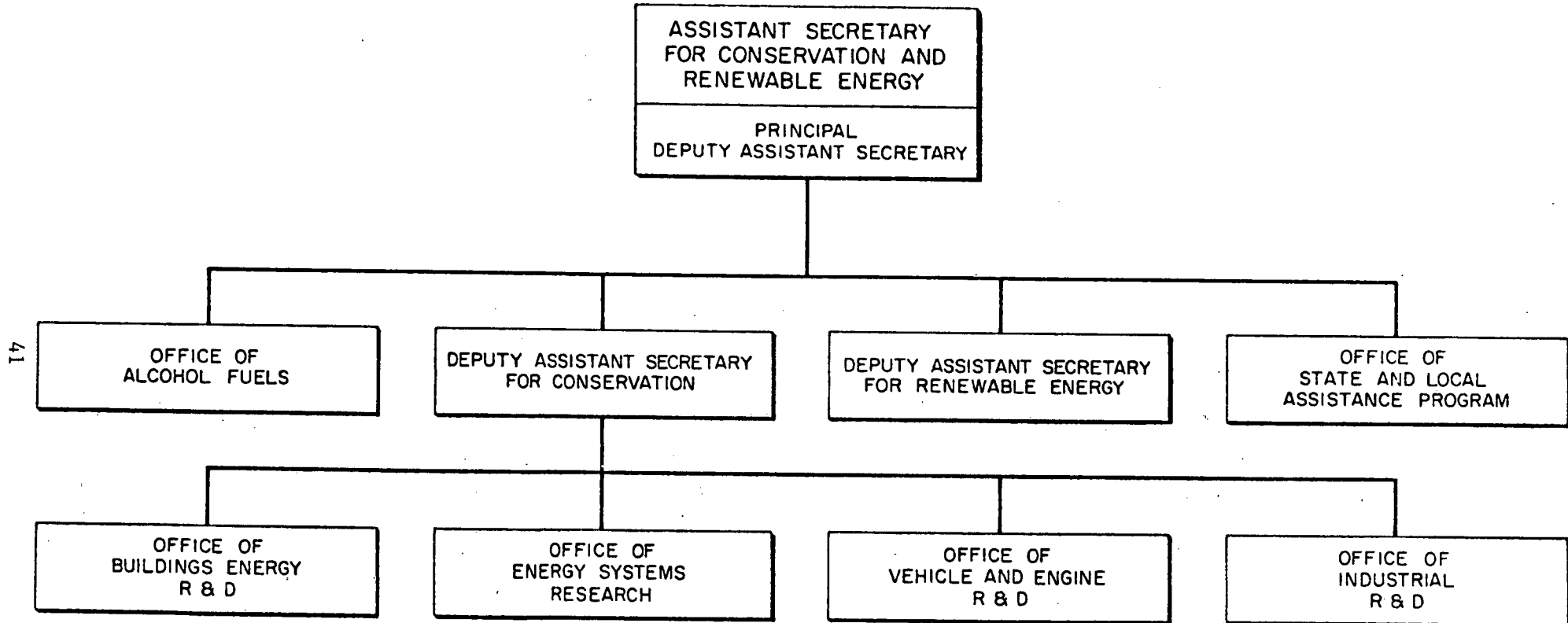

14

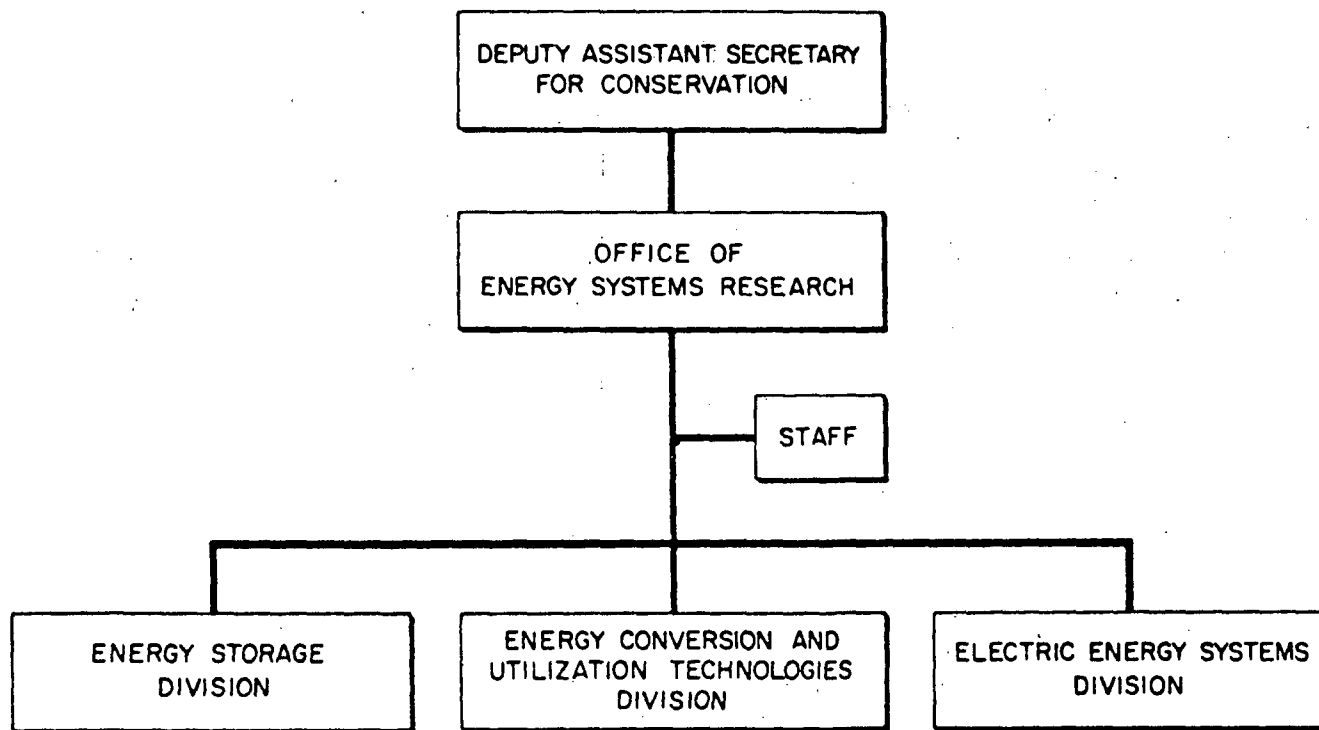

Fig. 1.2. Organization Elements of the DOE Office of Energy Systems Research (September 1981).

ENERGY CONVERSION AND UTILIZATION TECHNOLOGY SUBPROGRAM

Management Structure (Full Program Implementation)

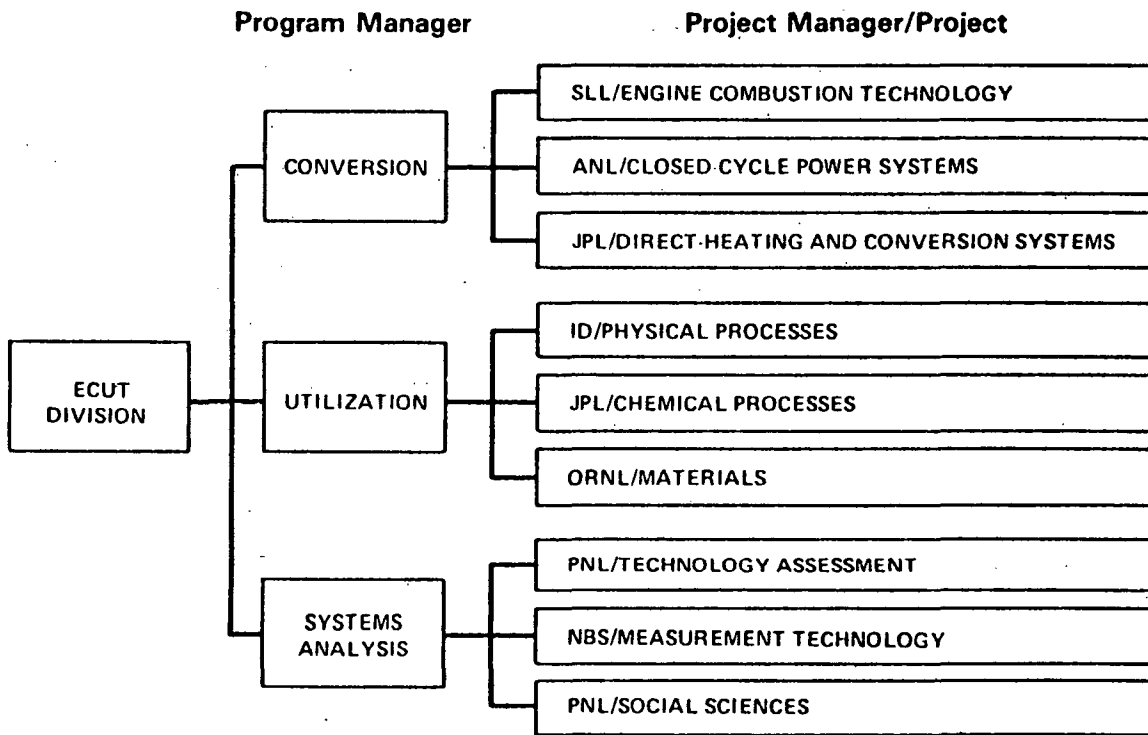

Fig. 1.3. Organization of the DOE Energy Conversion and Utilization Technologies (ECUT) Program.

SIGNIFICANT CHARACTERISTICS OF ECUT

- LABORATORY- OR BENCH-SCALE APPLIED RESEARCH AND EXPLORATORY DEVELOPMENT
- FUNDS DISTRIBUTED ROUGHLY EQUALLY BETWEEN RESEARCHERS IN GOVERNMENT, INDUSTRY, AND ACADEMIA
- CLOSE WORKING RELATIONSHIP WITH OER, APPLIED DOE CONSERVATION PROGRAMS, AND RELATED GOVERNMENT PROGRAMS
- PRIORITIZATION OF TASKS BY POTENTIAL ENERGY SAVING AND OTHER FACTORS

IN FY 1982, THERE HAVE BEEN FOUR STRUCTURAL CERAMICS TASKS
IN THE ECUT MATERIALS PROJECT

- REACTIVE METAL BRAZES FOR CERAMIC-CERAMIC AND CERAMIC-METAL JOINING
- ROTARY KILN METHOD OF PRODUCING SiC POWDERS
- FRICTION AND WEAR OF DISSIMILAR CERAMICS AT ELEVATED TEMPERATURES
- WORKSHOP ON CERAMIC ATTACHMENTS FOR HEAT ENGINE AND HIGH TEMPERATURE INDUSTRIAL HEAT EXCHANGER APPLICATIONS

FY 1982

REACTIVE METAL BRAZES FOR CERAMIC-CERAMIC AND CERAMIC-METAL JOINING

- LEVITATION MELTING AND SESSILE DROP TESTS FOR SCREENING DEVELOPMENTAL BRAZES
- DOUBLE CANTILEVER BEAM FRACTURE TESTS
- Ni-Cr-Ti FOR SiC TO SiC
- Ti-Cu-Be AND Ti-Zr-Be FOR PSZ TO DUCTILE IRON (ADIABATIC DIESEL)
- ORNL, \$110K, 10/1/81 - 12/31/82

- A. J. MOORHEAD (615) 574-4810

FY 1982

ROTARY KILN METHOD OF PRODUCING SiC POWDERS

- DEMONSTRATED THAT SiC POWDER CAN BE PRODUCED BY A ROTARY KILN PROCESS
 - LOWER ENERGY FOR PROCESSING THAN ACHESON FOR FINE PRODUCT
 - POTENTIALLY HIGHER PURITY AND FINE, NARROW DISTRIBUTION PARTICLES
- WORK BEGUN AT ORNL AND EAGLE-PICHER; PROCESS DEVELOPED BY ADVANCED REFRACTORY TECHNOLOGIES (ART) FOR ABRASIVES
- MAJOR EMPHASIS IN FY 1982 ON CHARACTERIZATION OF ART "CRUDE" PRODUCT
- RESULTS INDICATE ART "CRUDE" PRODUCT IS NOT THE FINE, HIGH PURITY, SINTERABLE POWDER ANTICIPATED WITHOUT FURTHER PROCESSING. ART HAS RECENTLY IMPROVED ART "CRUDE" PRODUCT TO REQUIRE LITTLE ADDITIONAL PROCESSING
- DEVELOPMENT WORK FOR SINTERABLE POWDER TRANSFERS TO DOE INDUSTRIAL PROGRAMS IN FY 1983
- ORNL, \$70K, 10/1/81 to 9/30/82
 - G. C. WEI (615) 574-5129

FY 1982

FRICITION AND WEAR OF DISSIMILAR CERAMICS AT ELEVATED TEMPERATURES .

- DETERMINE FRICTION COEFFICIENTS, WEAR RATES, AND WEAR MECHANISMS
- PIN-ON-DISK TESTS AT ROOM, 400°F, 800°F, IN DRY NITROGEN
 - 1 FT/SEC
 - LOADS ABOVE YIELD
- 5 x 5 MATRIX: SiC (KYOCERA SC201), Si₃N₄ (NTK EC128), PSZ (NILSEN), PLAIN Al₂O₃, ZrO₂-TOUGHENED Al₂O₃
- ADVANCED MECHANICAL TECHNOLOGY, INC. (AMTI), \$70K, 3/1/82 TO 2/28/83
 - PIN-ON-DISK TESTS
 - F. J. CARIGNAN (617) 964-2042
- ORNL, \$50K, 10/1/82 TO 9/30/82
 - WEAR ANALYSES
 - C. S. YUST (615) 574-4812

FY 1982

WORKSHOP ON CERAMIC ATTACHMENTS FOR HEAT ENGINE AND
HIGH-TEMPERATURE INDUSTRIAL HEAT EXCHANGER APPLICATIONS

- HELD JUNE 16, 1982, IN DEARBORN, MICHIGAN

- SELECTED REPRESENTATIVES FROM FOUR HEAT
ENGINE DEVELOPERS, FOUR HX DEVELOPERS,
THREE CERAMIC SUPPLIERS
 - HEAT ENGINES: Cummins, DDA, Ford, Garrett

 - HX: Garrett, Hague, Rocketdyne,
and Solar

 - SUPPLIERS: Carborundum, Coors, Norton

- RECOMMENDATIONS FOR FUTURE RESEARCH AND
DEVELOPMENT
 - SUMMARY TO BE PUBLISHED

**IN FY 1982 AND BEYOND, ECUT WILL EMPHASIZE FUNDAMENTALS OF
CERAMIC ATTACHMENTS AND FRICTION AND WEAR OF CERAMICS**

- CERAMIC ATTACHMENTS (MATERIALS PROJECT)
 - Develop Predictive Models for Typical Geometries
 - Verify Models
 - \$350K in FY 1983

- FRICTION AND WEAR OF CERAMICS AT ELEVATED TEMPERATURES
 - Emphasis on Mechanisms
 - Unlubricated and Lubricated Simple Sliding,
Oscillatory Sliding, and Rolling at High Temperatures
 - \$250K in FY 1983 on Simple Sliding to 1200°F

FOSSIL ENERGY STRUCTURAL CERAMICS PROGRAM;

**STANLEY J. DAPKUNAS (DOE)
RONNIE A. BRADLEY (ORNL)
JAMES P. CARR (ORNL)**

OFFICE OF FOSSIL ENERGY

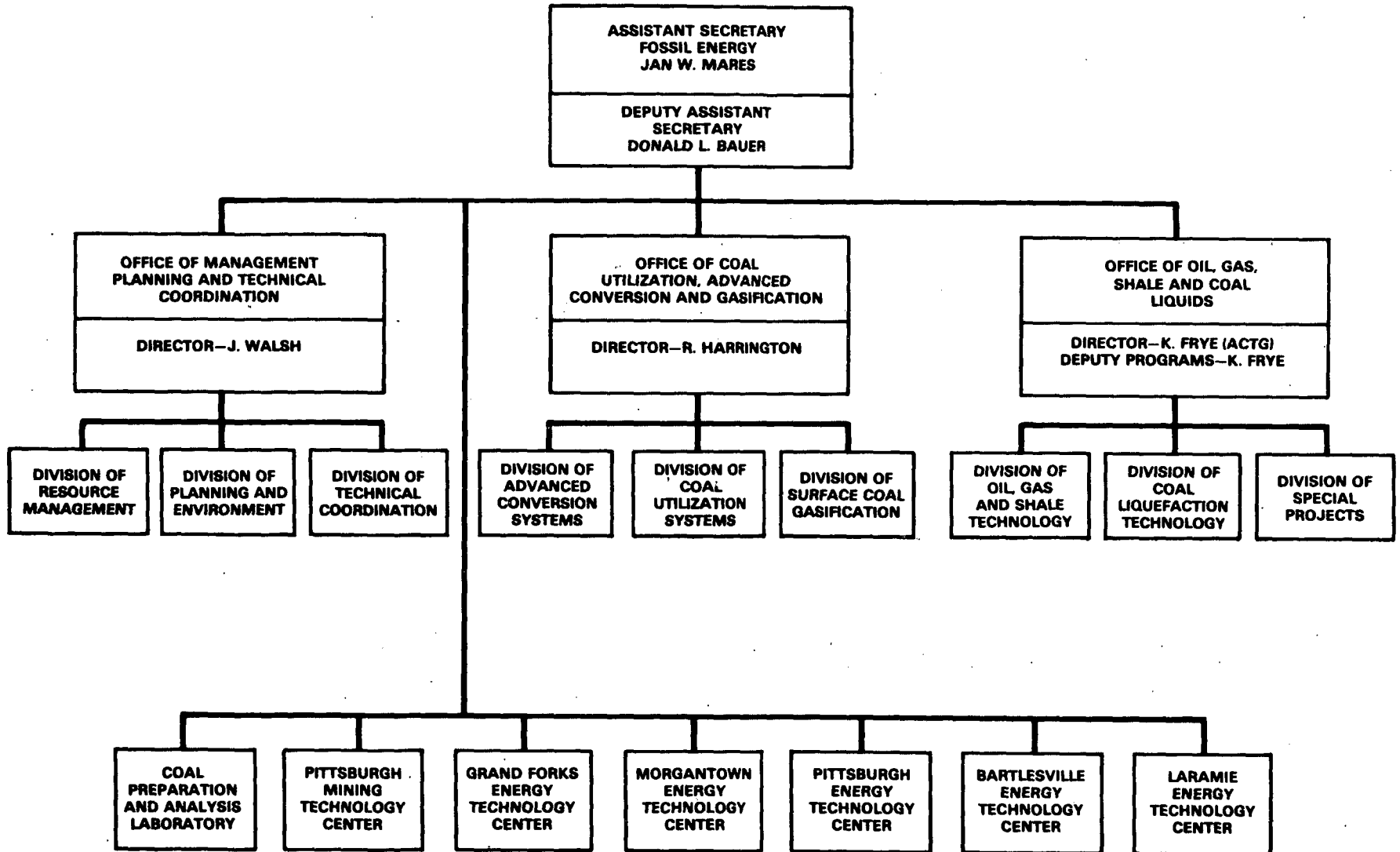

SURFACE COAL GASIFICATION COMPREHENSIVE (CIMF) PROGRAM

- **COMPONENTS**
- **INSTRUMENTATION**
- **MATERIALS APPLICATIONS**
- **FABRICATION TECHNOLOGY**

COAL GASIFICATION CIMF PROGRAM OBJECTIVES

DEVELOP ADVANCED TECHNOLOGY BASE TO:

- **LOWER GASIFICATION PLANT CONSTRUCTION/
MAINTENANCE AND OPERATING COST AND
TECHNICAL RISK**
- **HIGHER PROCESS EFFICIENCY**
- **IMPROVED SYSTEM CONTROL, SAFETY, RELIABILITY
AND MAINTAINABILITY**
- **MORE DURABLE, RELIABLE PLANT COMPONENTS/PARTS**

CIMF PROGRAM

FORMULATION

- **ONGOING ADVANCED DEVELOPMENT PROJECTS**
- **CONTINUATION OF ARTD PROJECTS**
- **NEW PROJECTS**

END POINT

- **WHERE INDUSTRY CAN ASSESS AND PICK-UP**
- **PROOF OF CONCEPT/ADVANCED DEVELOPMENT COMPLETION**

CERAMIC FABRICATION/APPLICATION TECHNOLOGY

FUNDING/YEARLY—\$500K

TASK A—LOCKHOPPER VALVE

- **LOS ALAMOS NATIONAL LABORATORY**

TASK B—HEAT EXCHANGER

- **ARGONNE NATIONAL LABORATORY**
- **SOLAR TURBINE INTERNATIONAL**

CERAMIC FABRICATION/APPLICATION TECHNOLOGY PROJECT

SPECIFIC END GOALS/REQUIREMENTS:

- **MORE DURABLE, RELIABLE COMPONENTS FOR HIGH TEMPERATURE ERROSIVE, CORROSIVE CONDITIONS**
- **HIGHER TEMPERATURE CAPABILITY COMPONENTS**

TWO PRONG PROJECT OBJECTIVES:

- **DEVELOP SPECIFIC CERAMICS DESIGN METHODOLOGY AND FABRICATION METHODS FOR COAL GASIFICATION APPLICATIONS**
- **COMPLETE EXPLORATORY DEVELOPMENT OF SPECIFIC COMPONENTS**

SMOOTH TUBE CERAMIC HEAT EXCHANGER ARTD—1977-81

FEASIBILITY DEMONSTRATION:

- **SUCCESSFUL FULL SIZE MODULE, 100 PSI SIC HEAT EXCHANGER OPERATION**

**STEADY STATE—2500°F FIRING TEMP.
2100°F OUTLET TEMP.**

SHUTDOWN —1000°F/MIN.

- **SUCCESSFUL TUBE JOINING INVESTIGATION**

**GLASS CERAMIC
SPHERICAL
BRAZED**

- **MATERIALS STRENGTH AND COAL-FIRED TEST DATA BASE**

**ALPHA-SINTERED SILICON CARBIDE
SINTERED SILICON CARBIDE
SUPER KT SILICON CARBIDE**

**COAL GASIFICATION
CERAMIC HEAT EXCHANGER
EXPLORATORY/ADVANCED
DEVELOPMENT PROGRAM
1982-1987 +**

- **DESIGN, FABRICATE AND TEST FINNED TUBE ALPHA SILICON CARBIDE HEAT EXCHANGER MODULE**
- **LABORATORY MATERIALS TESTS IN GASIFICATION REDUCING ATMOSPHERE**
- **DESIGN METHODOLOGY VALIDATION COMPONENT MECHANICAL TESTS**
- **DEVELOP APPROPRIATE QA METHODS/TESTS**
- **DESIGN, FABRICATE AND TEST MULTI MODULE PROTOTYPE HEAT EXCHANGER**
- **PREPARE DESIGN HANDBOOK**

**COAL GASIFICATION
CERAMIC VALVE
EXPLORATORY/ADVANCED
DEVELOPMENT PROGRAM
1982-1987 +**

- **PROJECT DEFINITION**
 - VALVE DESIGN REVIEW**
 - MATERIALS SELECTION**
 - DATA BASE ASSESSMENT**
- **DESIGN & FABRICATE COMPONENT PARTS**
- **DESIGN METHODOLOGY VALIDATION COMPONENT MECHANICAL TESTS**
- **LABORATORY MATERIALS TESTS**
- **DESIGN, FABRICATE AND TEST VALVE IN GASIFICATION ENVIRONMENT**
- **DEVELOP APPROPRIATE QA METHODS/TESTS**
- **PREPARE DESIGN HANDBOOK**

**DOE FOSSIL ENERGY
ADVANCED RESEARCH &
TECHNOLOGY DEVELOPMENT**

**STRUCTURAL CERAMICS PROGRAM
SEPTEMBER 29, 1982**

PROGRAM GOAL

**TO INCREASE THE FUNDAMENTAL UNDERSTANDING OF
THE BEHAVIOR OF STRUCTURAL CERAMICS APPLICABLE
TO FOSSIL APPLICATION**

OFFICE OF FOSSIL ENERGY

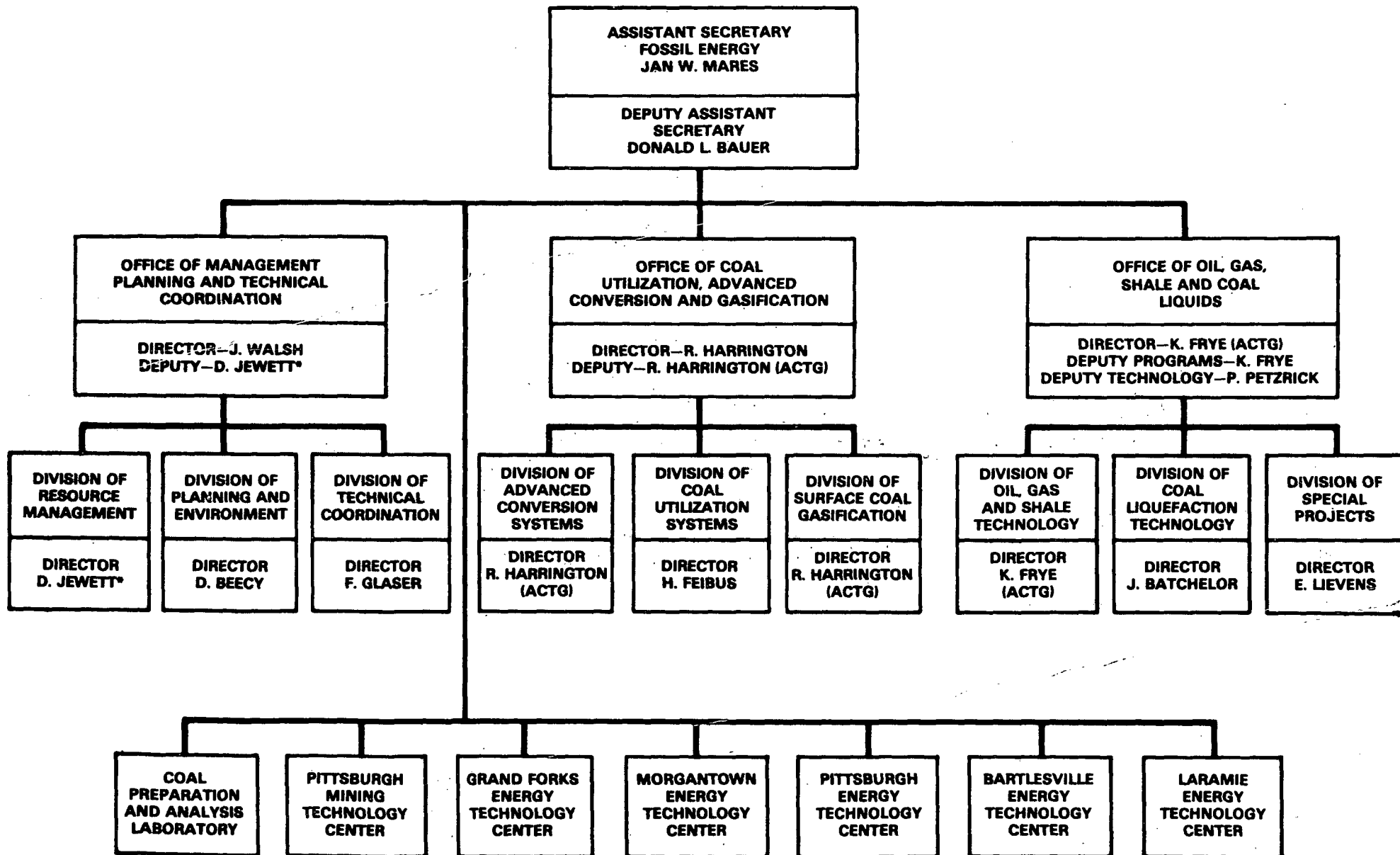

63

*DUAL POSITION

PROGRAM MANAGEMENT STRUCTURE

**DIVISION OF TECHNICAL COORDINATION
S.J. DAPKUNAS**

**OAK RIDGE OPERATIONS
OFFICE—E.E. HOFFMAN**

**OAK RIDGE NATIONAL
LABORATORY—R.A. BRADLEY**

**TECHNICAL MONITOR
PAUL BECHER—ORNL**

CONTRACTORS

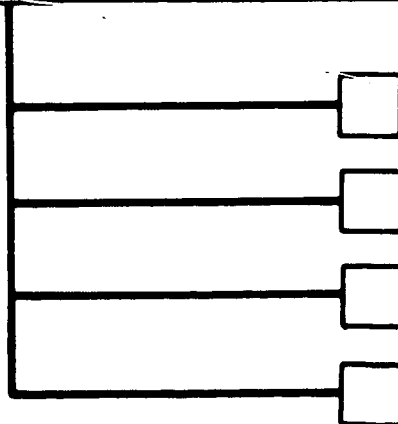

AR & TD PROJECTS

**TITLE: HIGH TEMPERATURE APPLICATIONS OF
STRUCTURAL CERAMICS**

**CONTRACTOR: NATIONAL BUREAU OF STANDARDS, N.
TIGHE, S. WEIDERHERN, R. FIELD**

PROJECT COST: \$260,000

OBJECTIVE:

- A. HIGH TEMPERATURE FRACTURE OF
STRUCTURAL CERAMICS**
- B. CRACK GROWTH MECHANISM MAP
DEVELOPMENT**
- C. MICROSTRUCTURE AND PHASE
ALTERATION**
- D. MICROSTRUCTURE AND FRACTURE IN
REACTIVE ENVIRONMENTS**

AR & TD PROJECTS

TITLE: EVALUATION OF MECHANICAL
BEHAVIOR AND STRENGTH OF CERAMIC
MATERIALS

CONTRACTOR: OAK RIDGE NATIONAL LABORATORY,
V. TENNERY

PROJECT COST: \$172,000

OBJECTIVE: DETERMINE SURFACE REACTIONS,
MICROSTRUCTURAL AND STRENGTH
CHANGES OF SiC HEAT EXCHANGE
TUBES AFTER LONG TERM EXPOSURE TO
COAL COMBUSTION ENVIRONMENTS

AR & TD PROJECTS

TITLE: CERAMIC HEAT EXCHANGER
TECHNOLOGY DEVELOPMENT

CONTRACTOR: SOLAR TURBINES, INTERNATIONAL/
M. WARD

FUNDING LEVEL: \$350,000

OBJECTIVE: DEVELOP A TECHNOLOGY BASE OF
DESIGN DATA FOR CERAMIC TUBULAR
HEAT EXCHANGERS

AR & TD PROJECTS

TITLE: SiC POWDER SYNTHESIS AND
CHARACTERIZATION, FABRICATION AND
MICROSTRUCTURE

CONTRACTOR: OAK RIDGE NATIONAL LABORATORY,
F. WEI

PROJECT COST: \$232,000

OBJECTIVE: CHARACTERIZE MICROSTRUCTURE AND
PROPERTIES AS A FUNCTION OF
POWDER PROPERTIES AND PROCESSING
PARAMETERS

AR & TD PROJECTS

TITLE: SHORT FIBER REINFORCED CERAMICS

CONTRACTOR: LOS ALAMOS NATIONAL LIBRARY, F.D. GAC

PROJECT COST: \$200,000

**OBJECTIVE: CHARACTERIZATION OF SiC AND Si₃N₄
REINFORCED WITH WHISKERS FORMED BY
VAPOR DEPOSITION**

ARTD PLANS

- 1. CONTINUE FUNDING AT ABOUT \$1M/YEAR**
- 2. EMPHASIZE DEVELOPMENT OF A FUNDAMENTAL UNDERSTANDING OF THE MICROSTRUCTURAL AND MECHANICAL BEHAVIOR ASPECTS WHICH HAVE A BEARING ON FOSSIL APPLICATIONS.**

CERAMICS IN THE VEHICLE PROPULSION TECHNOLOGY DEVELOPMENT PROGRAM
AND A PREVIEW OF A HEAT ENGINE CERAMIC TECHNOLOGY PROGRAM PLAN

ROBERT B. SCHULZ, DOE

Ceramics in the Vehicle Propulsion Technology Development Program and a Preview of a Heat Engine Ceramic Technology Program

Briefing

September 29, 1982

Robert B. Schulz

Office of Vehicle and Engine Research and Development

Department of Energy

Washington, D.C. 20585

(202) 252-8064

Office of Vehicle and Engine R&D in the Department of Energy's Organization

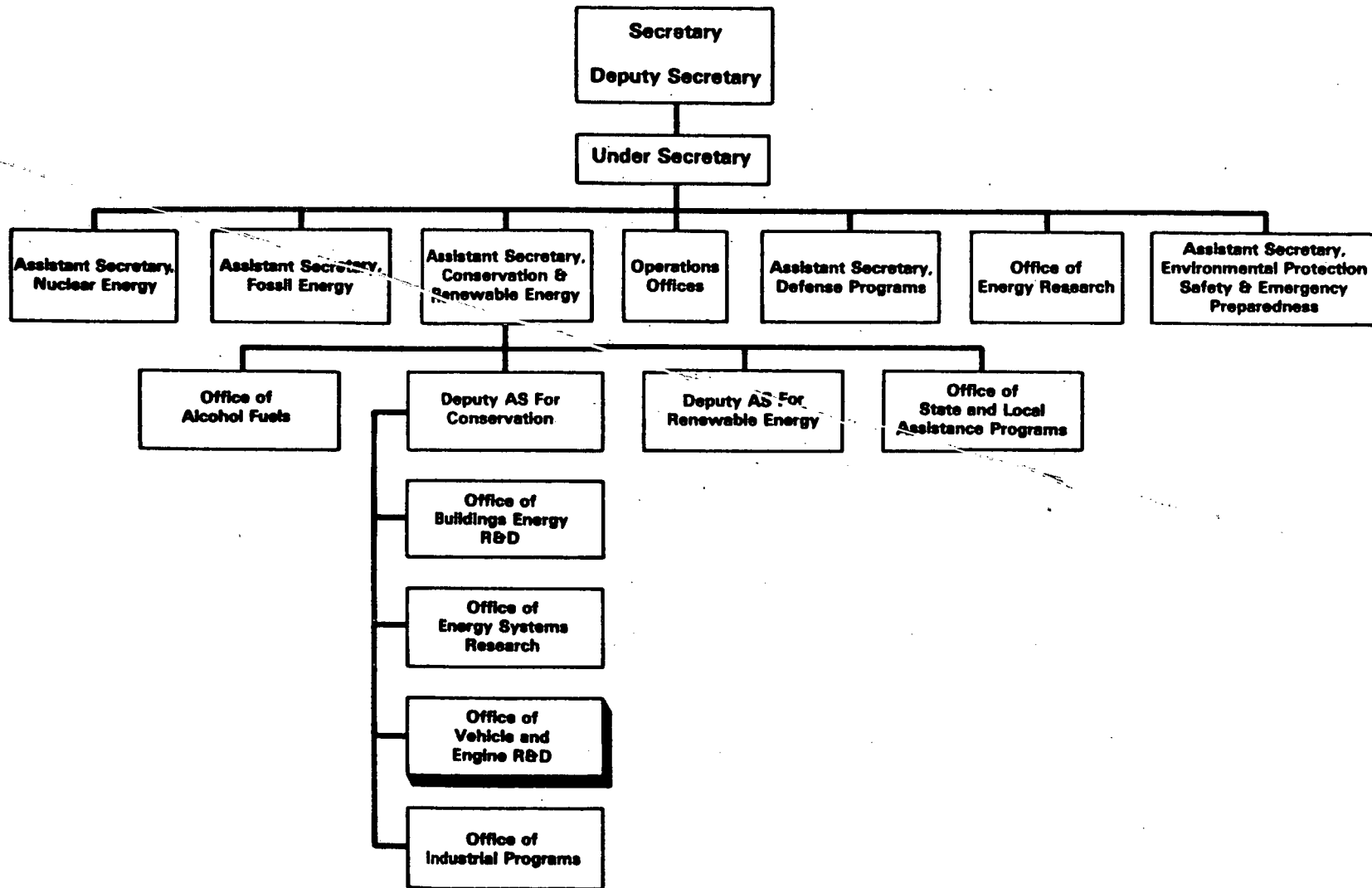

PROGRAM ORGANIZATION

VEHICLE PROPULSION TECHNOLOGY DEVELOPMENT

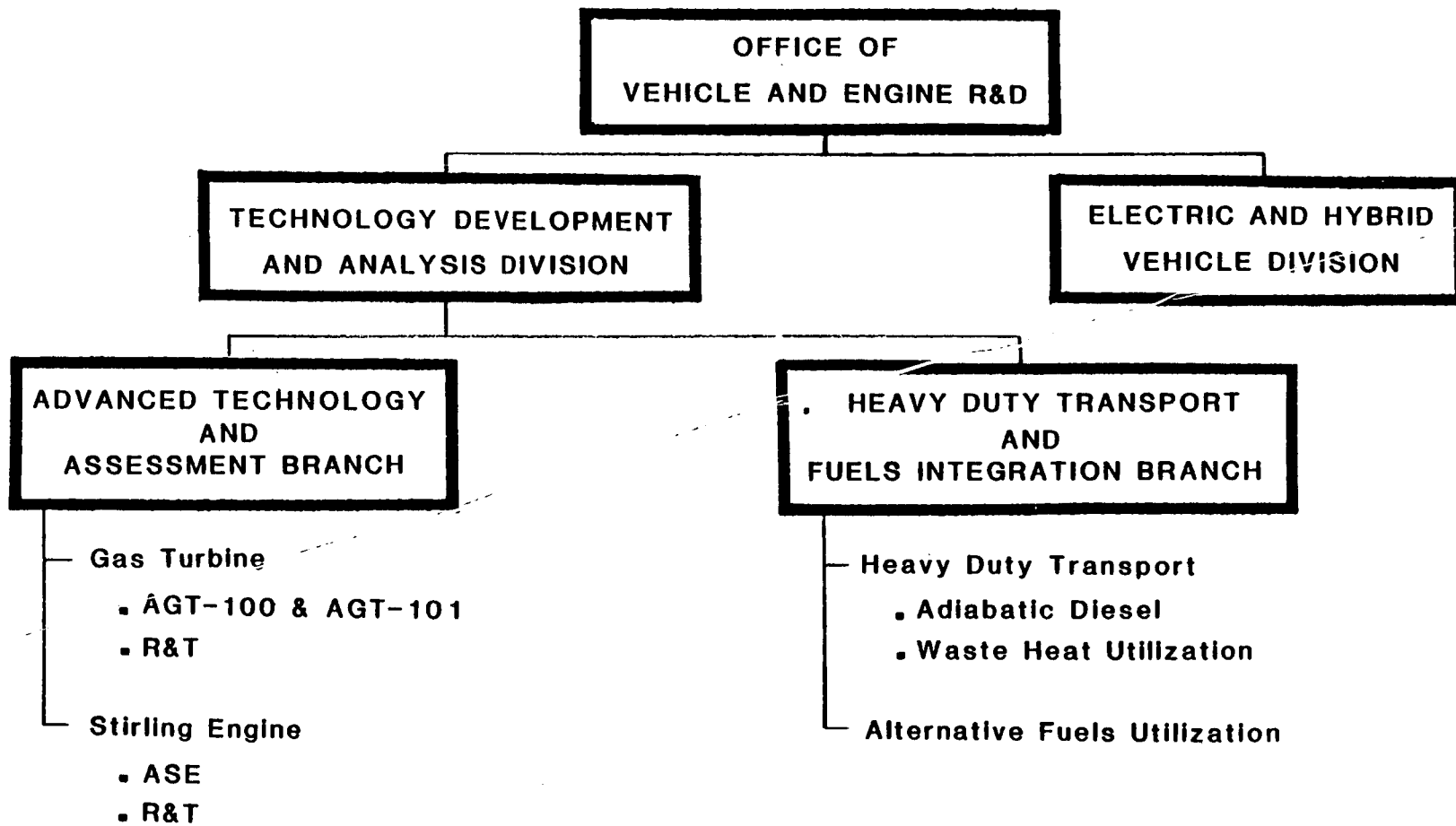

Vehicle Propulsion Technology Development

SPECIFIC OBJECTIVES

- **To Provide Automotive Industry with Advanced Engine Technology by 1985 that Demonstrates**
 - **At Least 30% Improvement in MPG Over Comparable Conventional Engines**
 - **Capability to Meet Emissions, Safety and Noise Standards**
 - **Alternative Fuels Capability**
 - **Competitive Initial and Life Cycle Costs**
 1. **Gas Turbine — Proof of Concept**
 2. **Stirling Engine — Proof of Concept**
 3. **Heavy Duty Diesel — Component Technology**

Vehicle Propulsion Technology Development

**Ceramic Technology is the
Key to Success**

- High Temperature Operations
- Corrosive Environment
- Potential for Low Cost
- Light Weight and Inertia Components
- Elimination of Strategic Materials

Benefit of High Temperature Gas Turbine Operation

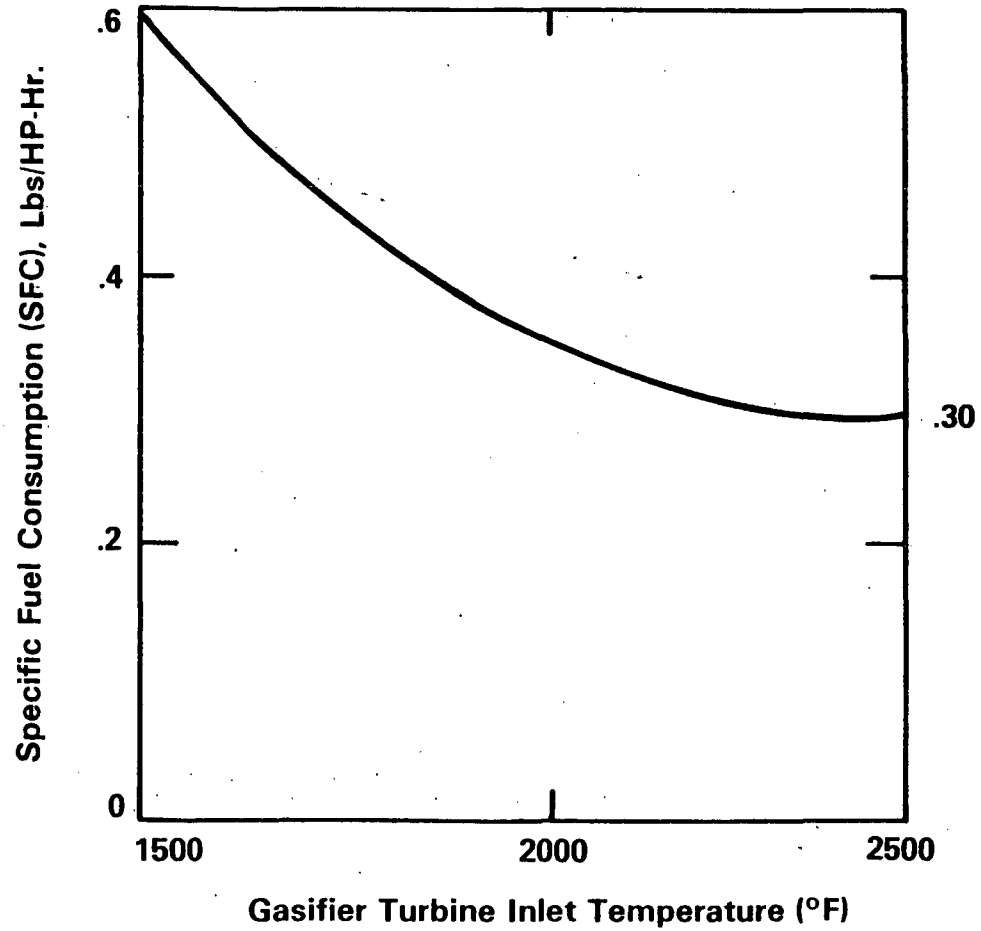

AGT 100

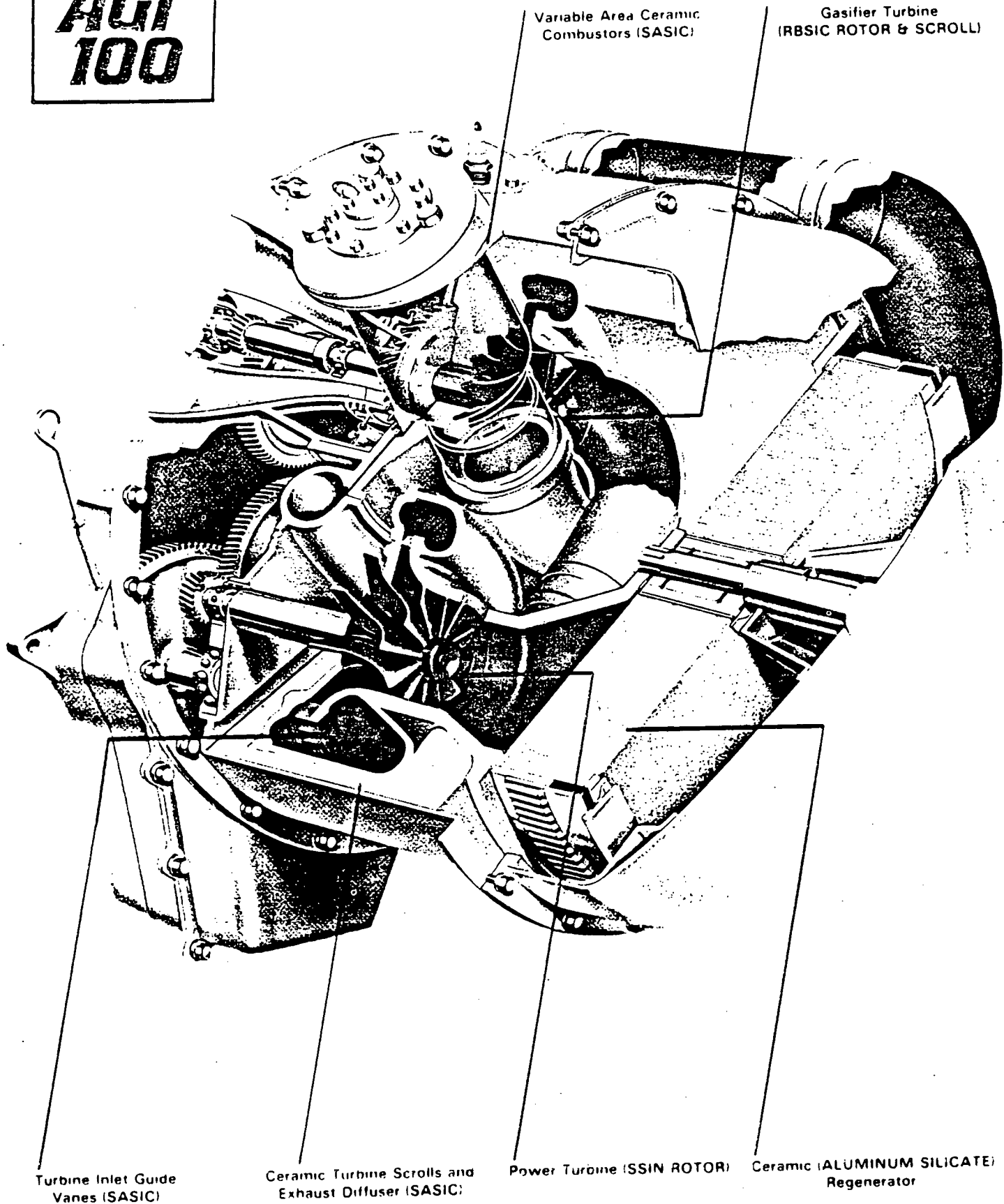

AGT101 POWER PLANT

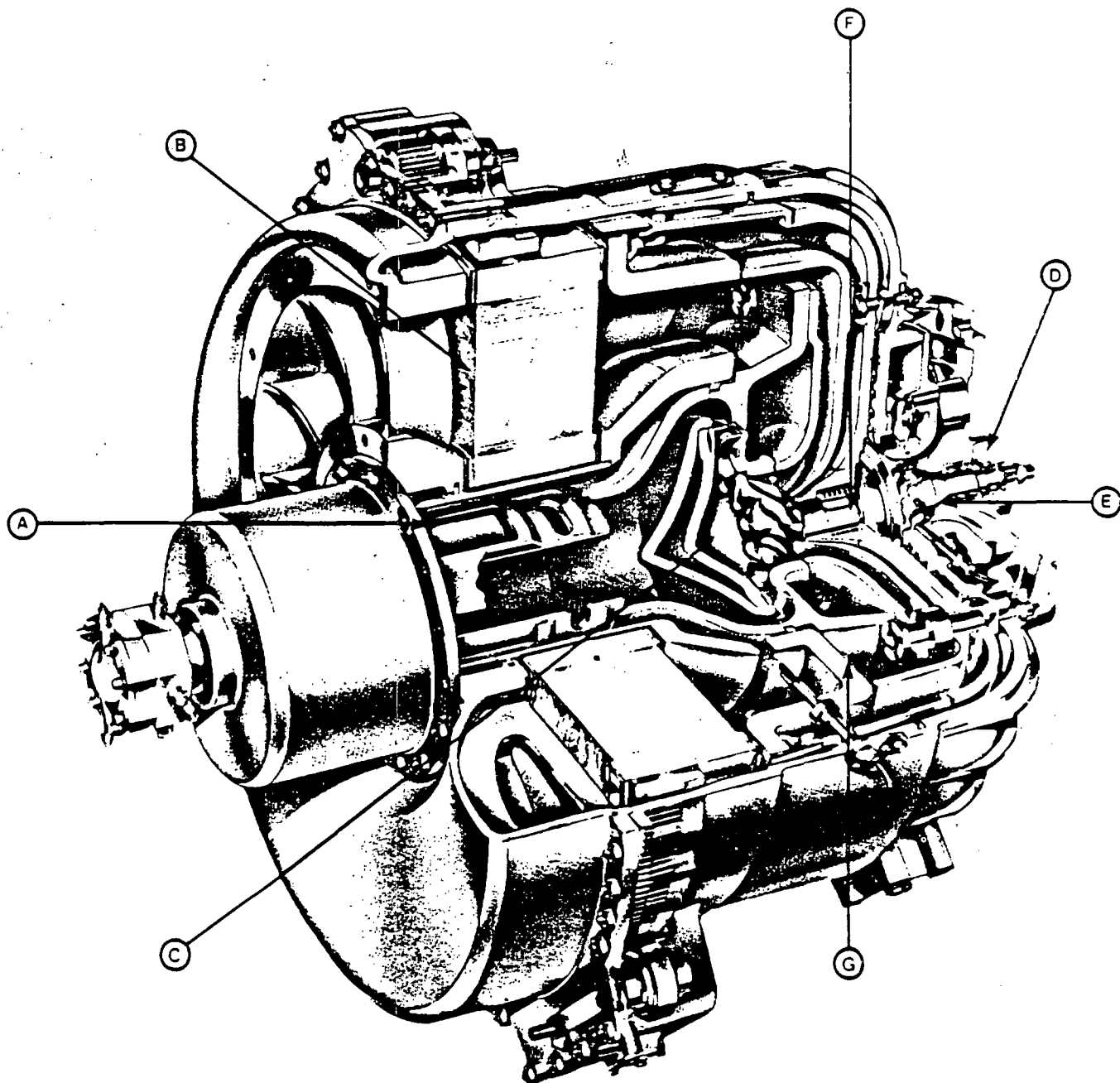

A. Combustor

- Premix/Prevaporizing Variable Geometry
- Ceramic Material

B. Regenerator

- Ceramic Material
- Rotary—Extruded Matrix
- Developed Seals and Bearings

C. Turbine

- Single Stage, High Work Radial
- Ceramic Material
- 2500°F Maximum Turbine Inlet Temperature

D. Ball Bearing

- Radial and Thrust Loads

E. Compressor

- Single Stage Centrifugal
- 5:1 Pressure Ratio
- Powder Metal Aluminum
- Variable Inlet Guide Vanes

F. Foil Gas Bearing

G. Ceramic Structures

- Transition Liners, Turbine Shroud, Turbine Stator
- Materials include RBSN, Sintered SiC, RSSiC

ADVANCED DIESEL BASE POWER PLANTS

1 BASE ENGINE INSTALLATION

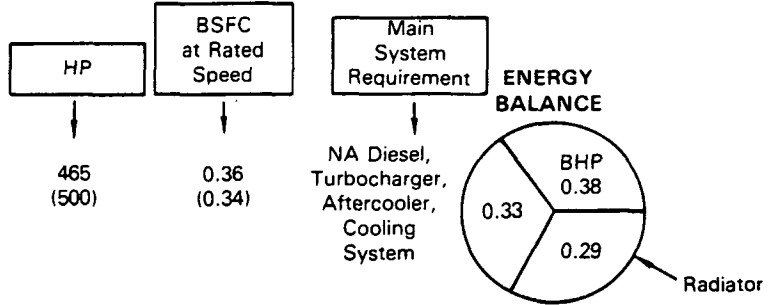
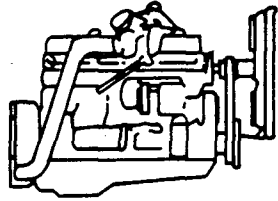

2 TURBOCOMPOUND DIESEL TORSIONAL ISOLATOR

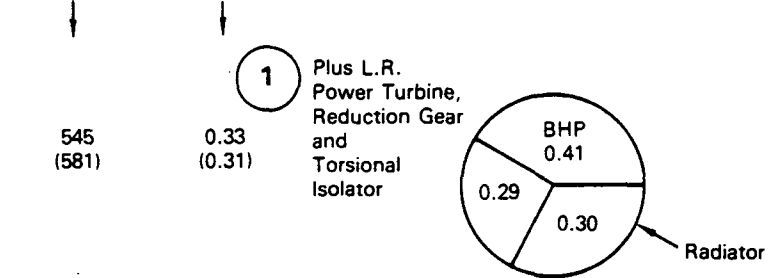
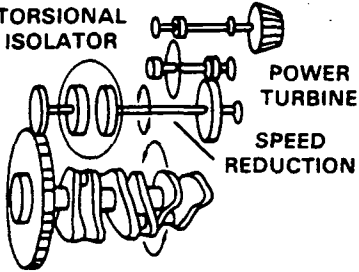

3 ADIABATIC DIESEL ENGINE

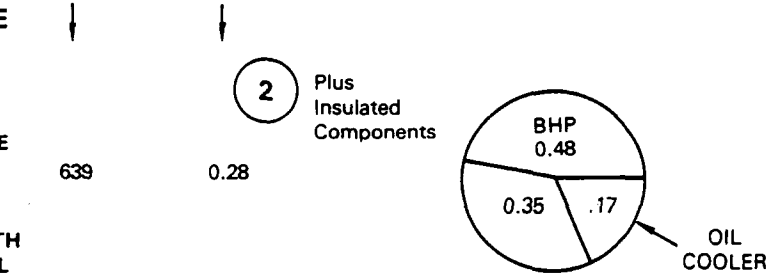
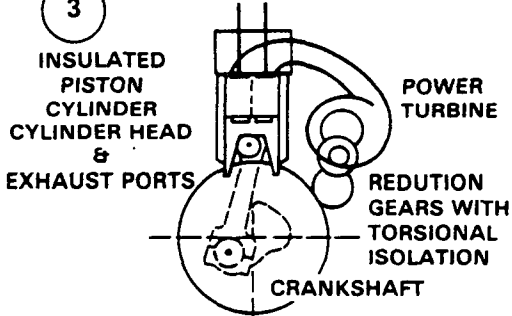

4 ADVANCED MINIMUM FRICTION ENGINE

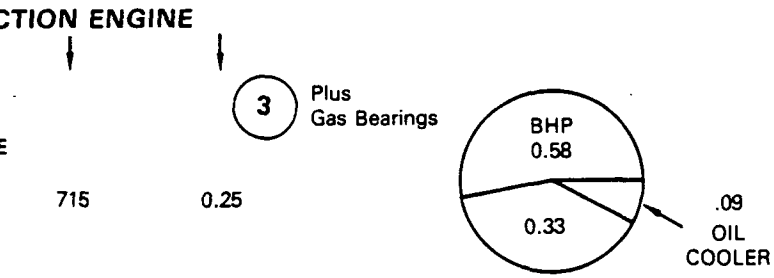
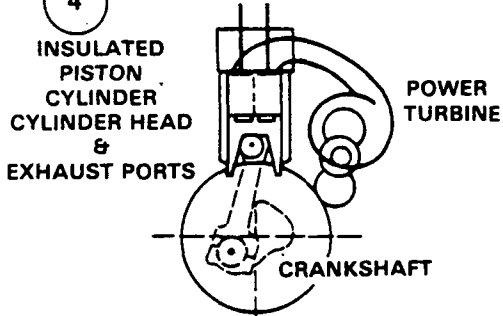

5 RANKINE BOTTOMING CYCLE

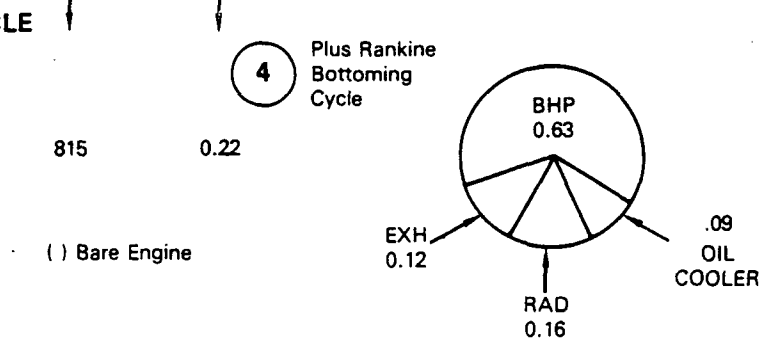
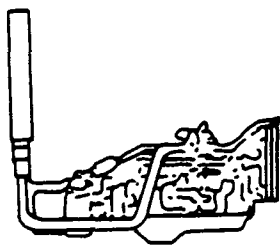

Vehicle Propulsion Technology Development

Funding for Ceramics

T8

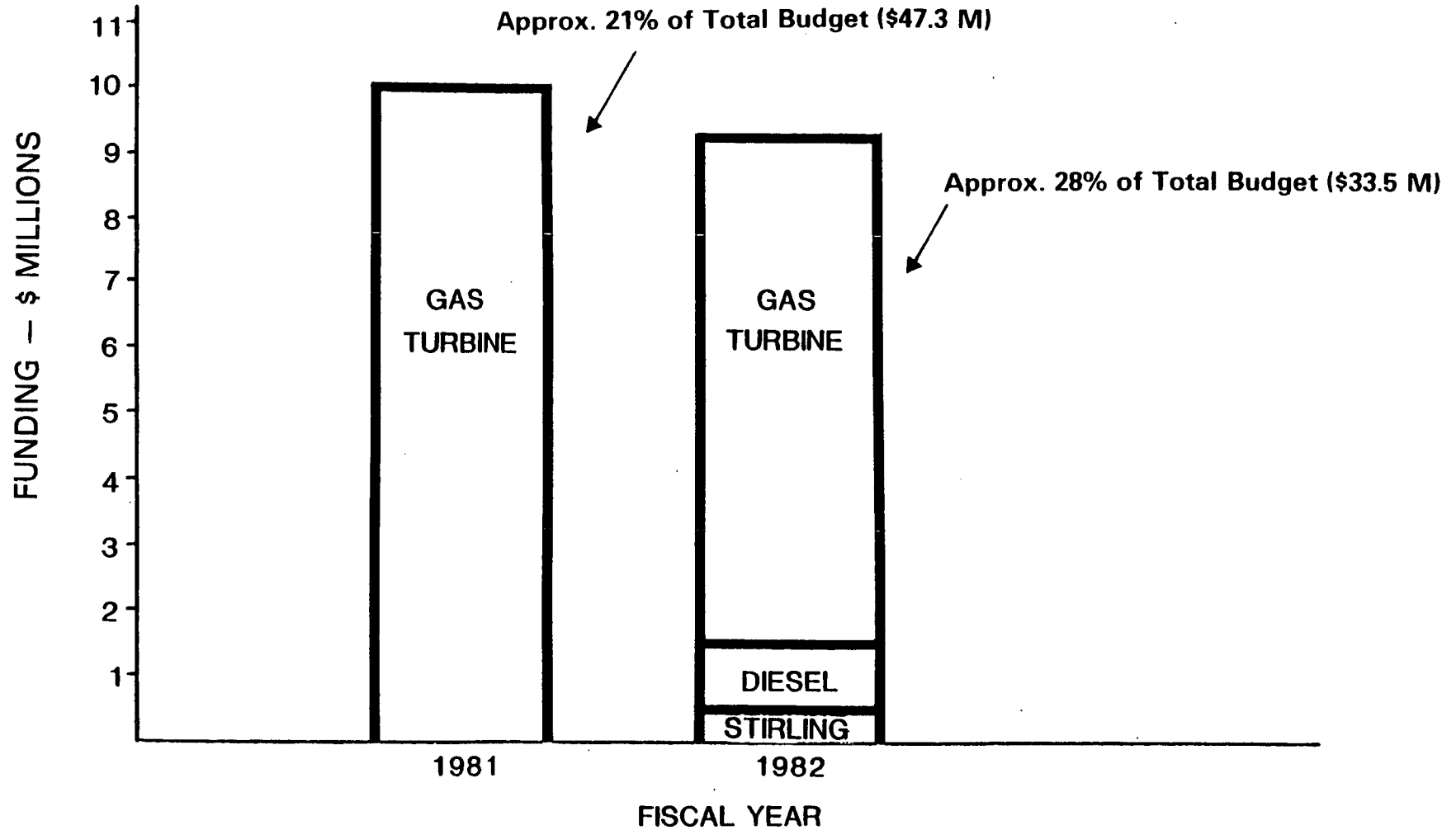

Vehicle Propulsion Technology Development

Scope of Ceramic Technology Activities

IMPROVED MATERIALS DEVELOPMENT

- **Silicone Nitride (Si_3N_4)**
 - Ford Motor Company — RBSN, SRBSN
 - AiResearch Casting — RBSN, SSN
 - General Electric Research — SSN (Be Si_3N_4)
 - GTE Laboratories — SSN
 - AMMRC — SSN

- **Silicon Carbide (SiC):**
 - Carborundum — SSC, RBSC

- **Silicates (AS, MAS, LAS):**
 - Corning Glass — AS, LAS
 - NGK Locke — MAS

- **Oxides (Al_2O_3 , ZrO_2)**
 - ORNL — Dispersion Toughened
 - U. of Michigan — TTZ

Vehicle Propulsion Technology Development Scope of Ceramic Technology Activities (Continued)

MANUFACTURING TECHNOLOGY

- NASA Lewis — Hot Isostatic Pressing (HIP)
- DDA/Carborundum — Blade Matrix Study

NDE TECHNIQUES

- Detroit Diesel Allison — Ultrasonics, SPAS, SLAM
- NASA Lewis — Ultrasonics, SLAM
- Ford Motor — Micro-Focus X-Ray

Vehicle Propulsion Technology Development Scope of Ceramic Technology Activities (Continued)

MATERIALS CHARACTERIZATION

- Garrett Turbine Engine — 3500 Hr Burner Rig
- Detroit Diesel Allison — CATE Project Testing
- AMMRC — Screening Tests

LIFE PREDICTION/DESIGN

- AMMRC — Life Prediction Methodology
- Ford Motor — Time Dependent Properties
- Ford Motor — Stator Testing
- Garrett Turbine Engine — Contact Stresses

Vehicle Propulsion Technology Development Gas Turbine – Proof of Concept Engine

RECENT ACCOMPLISHMENTS

- **Major Advancements Achieved in Shape, Fabrication and Material Strengths of Structural Ceramics**
 - Ford Cold-Spun a SRBSN Simulated AGT Rotor to 134% Design Speed (134,000 RPM) with No Failure
 - GM Cold-Spun a Carborundum α SIC Fully Bladed AGT Rotor to 126% Design Speed (109,000 RPM) with No Failure
 - Successfully Ran CATE Heavy Duty Test Engine with Ceramic Components at 100% Speed (36,905 RPM) and 2070°F Rotor Inlet Temperature

- **Improved Aerodynamic Performance of Small Turbine Components Verified**
 - Compressor and Turbine Components for Both GM and Garrett/Ford Designs Have Met or Exceeded Initial Performance Goals (80%-89%)

Vehicle Propulsion Technology Development

Ceramic Supporting Research and Technology Accomplishments Since 1977

- Overcame Silicate Ceramic Heat Exchanger Corrosion and Reliability Problems for Applications to 1000°C
- Developed Gas Pressure Sintering of Si_3N_4
- Improved Properties of Sintered/and Reaction-Bonded Carbide and Nitride Ceramics Made From SiC , Si_3N_4 and Si-metal Powders
- Developed Fabrication Processes and Tested Many Complex Turbine Engine Components
- Made Advances in Life-Prediction and Non-Destructive Testing

AGT101 CERAMIC PARTS



REGENERATOR SHIELD

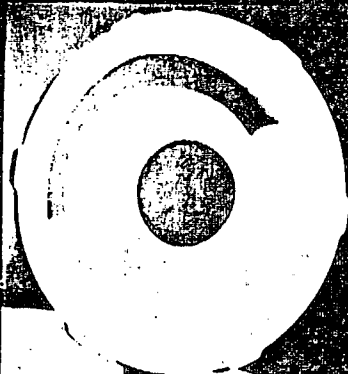

FLOW SEPARATOR HOUSING

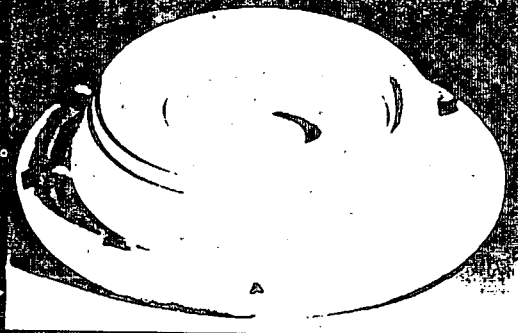

TURBINE SHROUD



TRANSITION DUCT

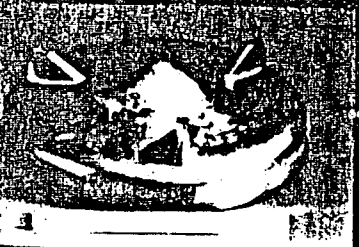

COMBUSTOR BAFFLE



TURBINE BACK SHROUD



TURBINE ROTOR

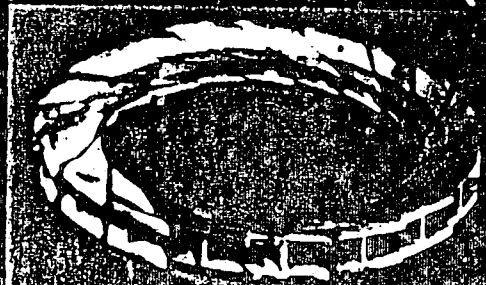

TURBINE STATOR

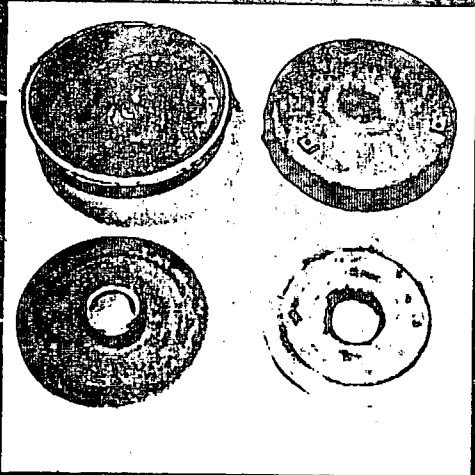

INNER DIFFUSER

OUTER DIFFUSER

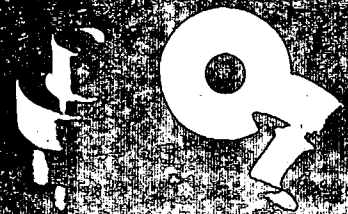

DUCT SPACERS

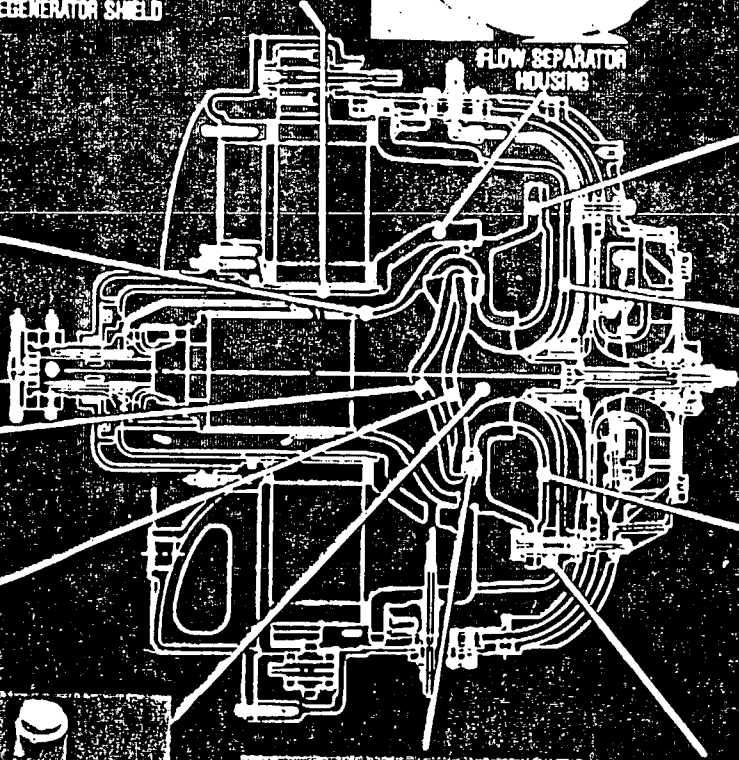

76653

87

MS 1310-2
ARTO0288-20



AGT101
by GANHATA Ford

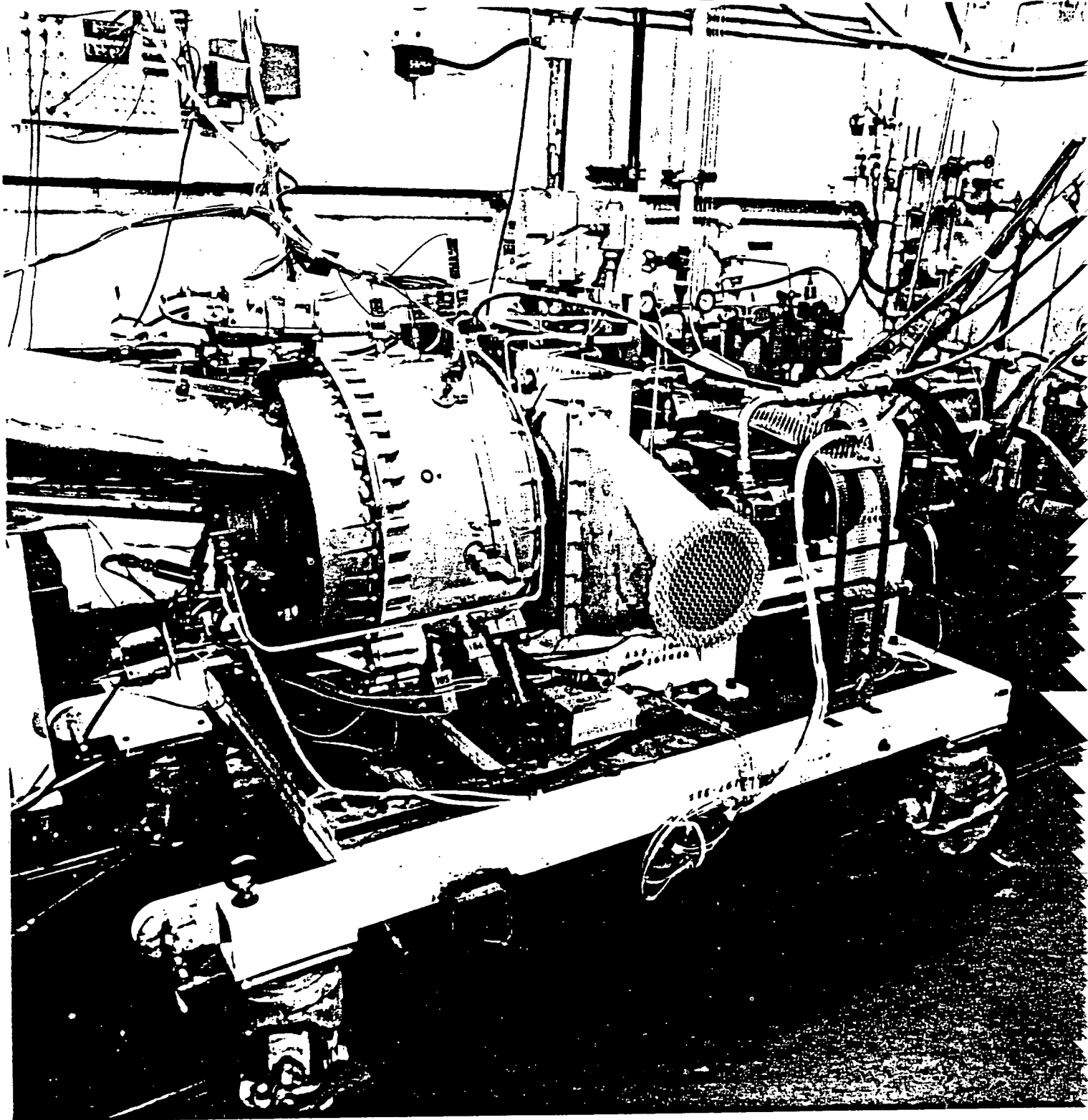

AGT101 Engine in Test Cell

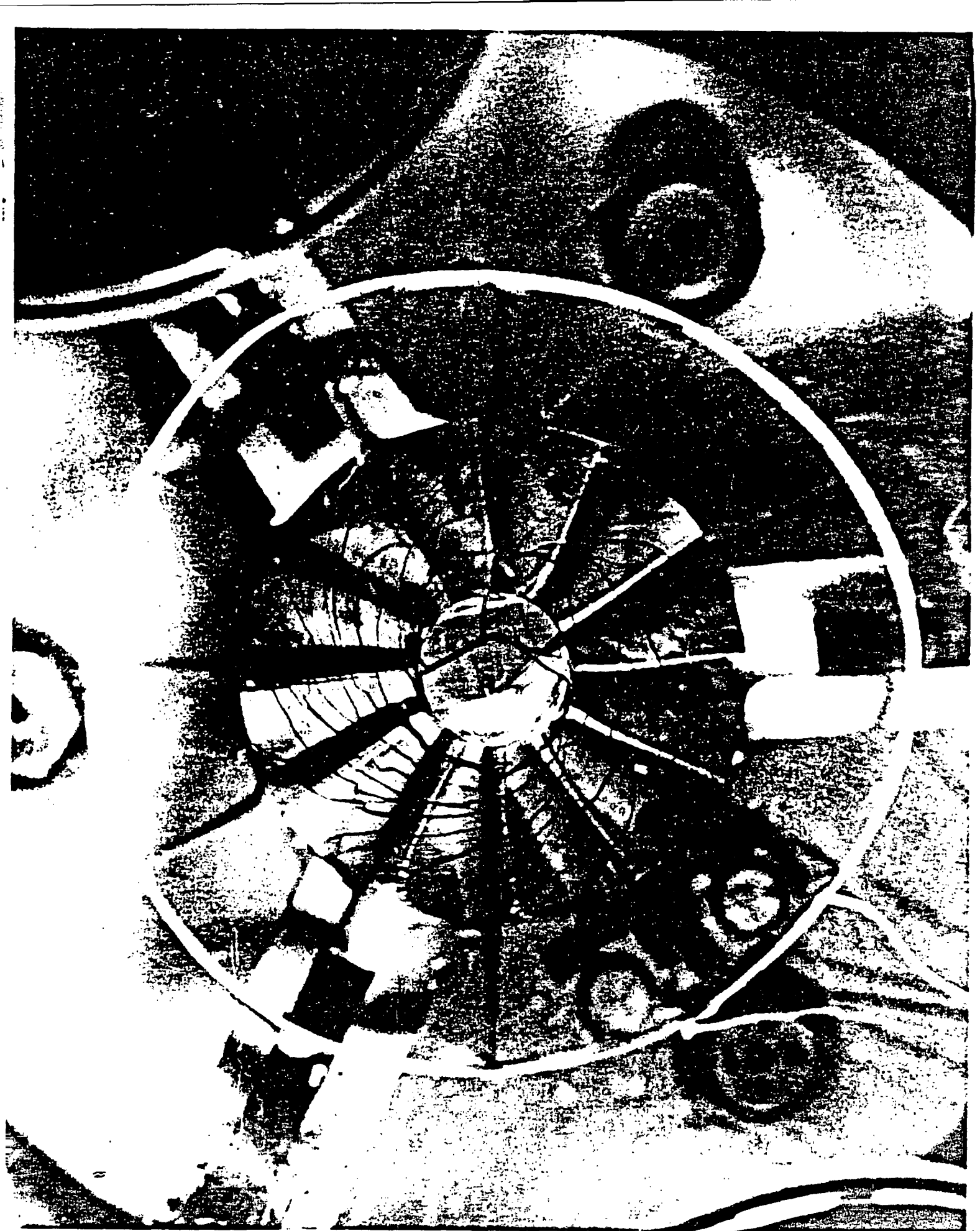

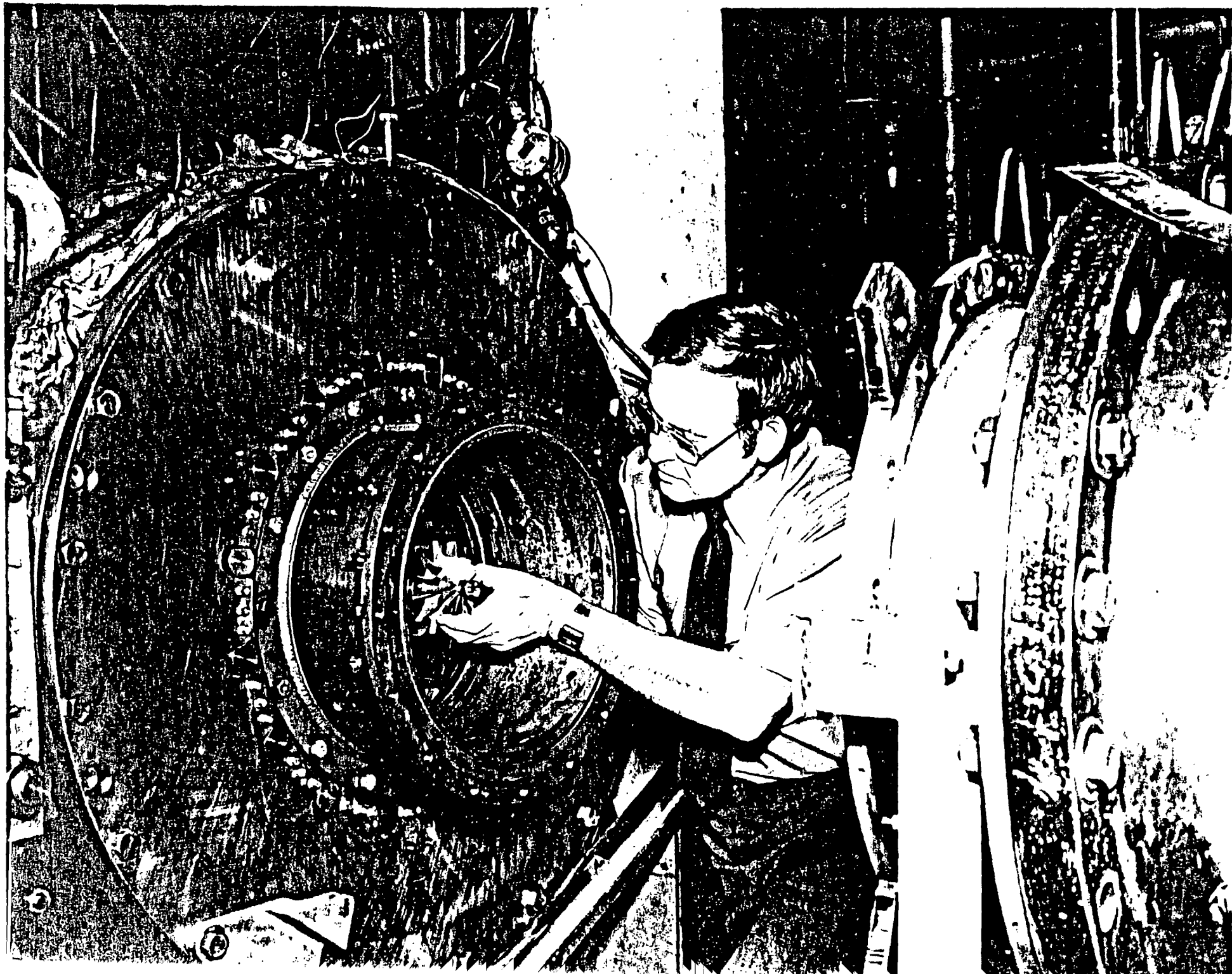

Vehicle Propulsion Technology Development

Impact of New Administration Strategy

- Deemphasis of Demonstration and Near Term/Product Specific Activities
- Concentrate on High Risk-High Payoff Long Term Generic R&D
- Convert Engine Type Programs to "Proof of Concept" Technology Efforts
- Develop Maximum Industry Cooperation and Minimum Competition with Normal Market Forces
- Operate with Reduced Budgets

Ceramic Technology for Advanced Heat Engines

Planning Objectives

- **Make Plan Consistent with Administration Emphasis on Long-Range Generic Research**
- **Establish Scope, Technical and Resource Requirements, and Priorities for Research Program**
- **Avoid Duplication of Other Industry and Government Efforts**
- **Determine Best Utilization of Available Government Funding**

Ceramic Technology for Advanced Heat Engines

DOE/ORNL Planning Process

- Obtain Input and Support from Ceramic Industry, Heat Engine Industry, Government Laboratories and Universities
- Prepare an Economic Analysis to Establish Benefits of Program (Argonne)
- Establish Patent, Proprietary Information, Cost Sharing and Other Legal Policy with Industry
- Coordinate Technical Planning with NASA and Other Government Programs

Ceramic Technology for Advanced Heat Engines

Preliminary Planning Results

- **Basic Materials/Processing, Data Base/Life Prediction and Design Methodology Advances Needed to Increase Component Reliability of Current and New Ceramics**
- **Engine Programs are Required to Provide Iterative Component Fabrication and Component Rig and Engine Testing Needed to Establish Requirements and Component Reliability.**
- **Long Term (5-10 year) Stable Base Technology Program Needed with Multi-Year Funding Commitment**

Approach To Reliable Ceramic Components For Advanced Heat Engines

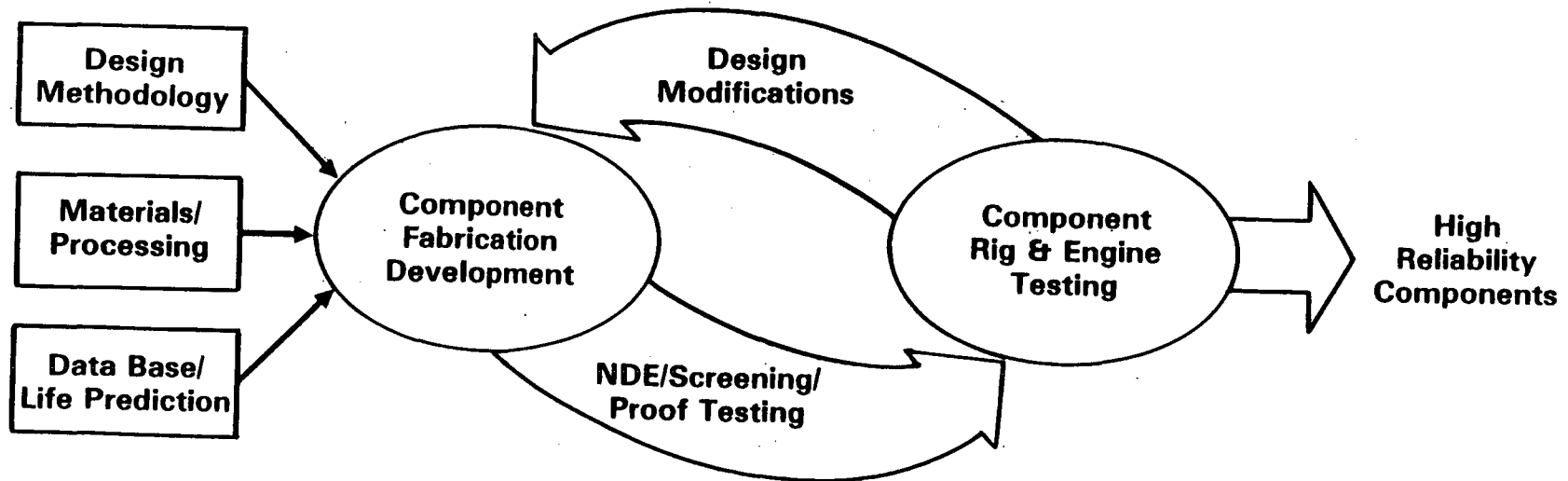

Ceramic Technology For Advanced Heat Engines

Requirements For Reliable Components

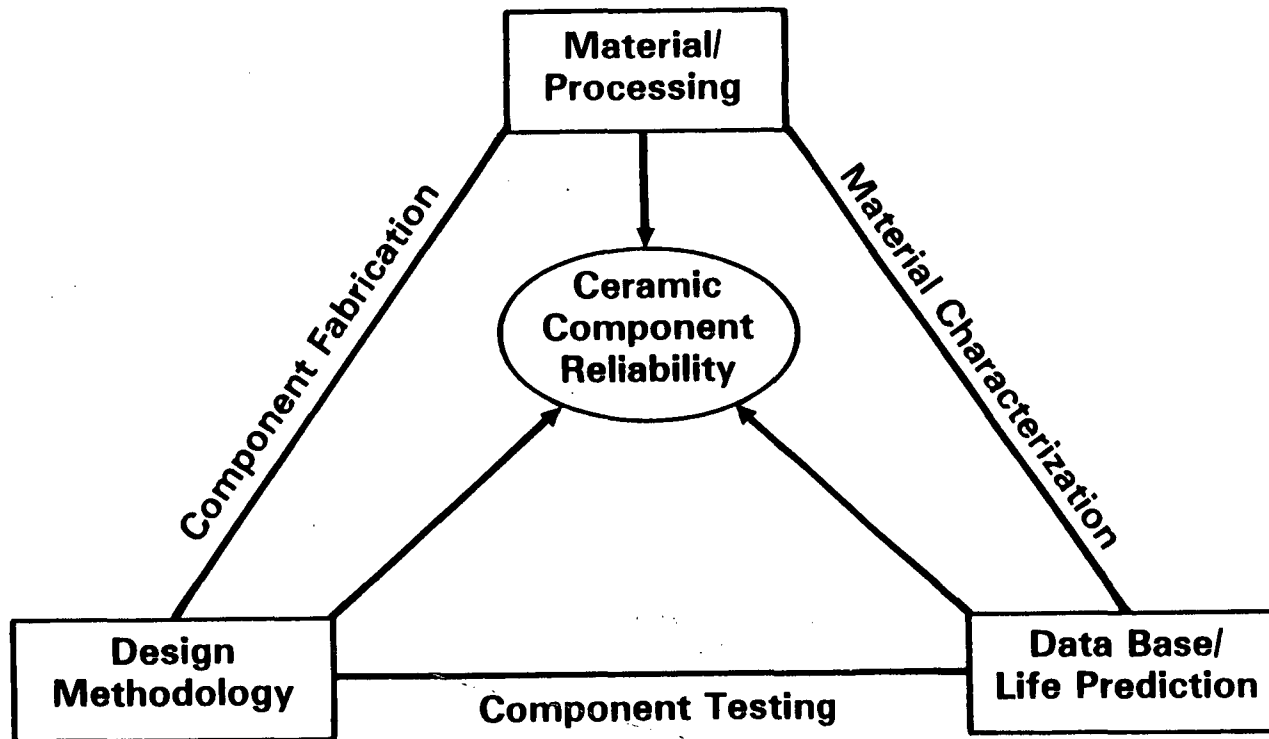

Ceramic Technology For Advanced Heat Engines

Work Breakdown Structure

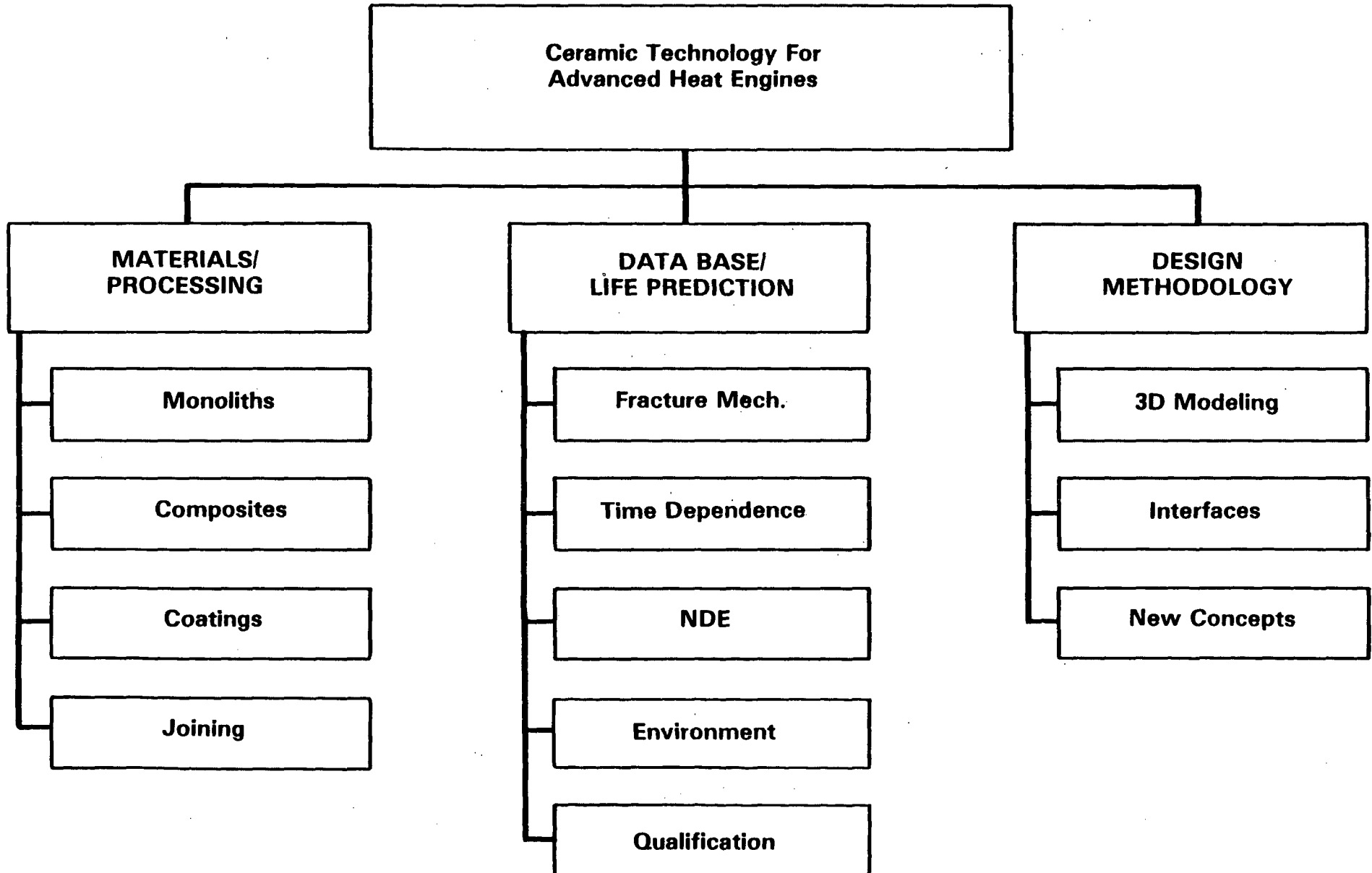

Ceramic Technology For Advanced Heat Engines Program

DOE & NASA Coordinated Implementation

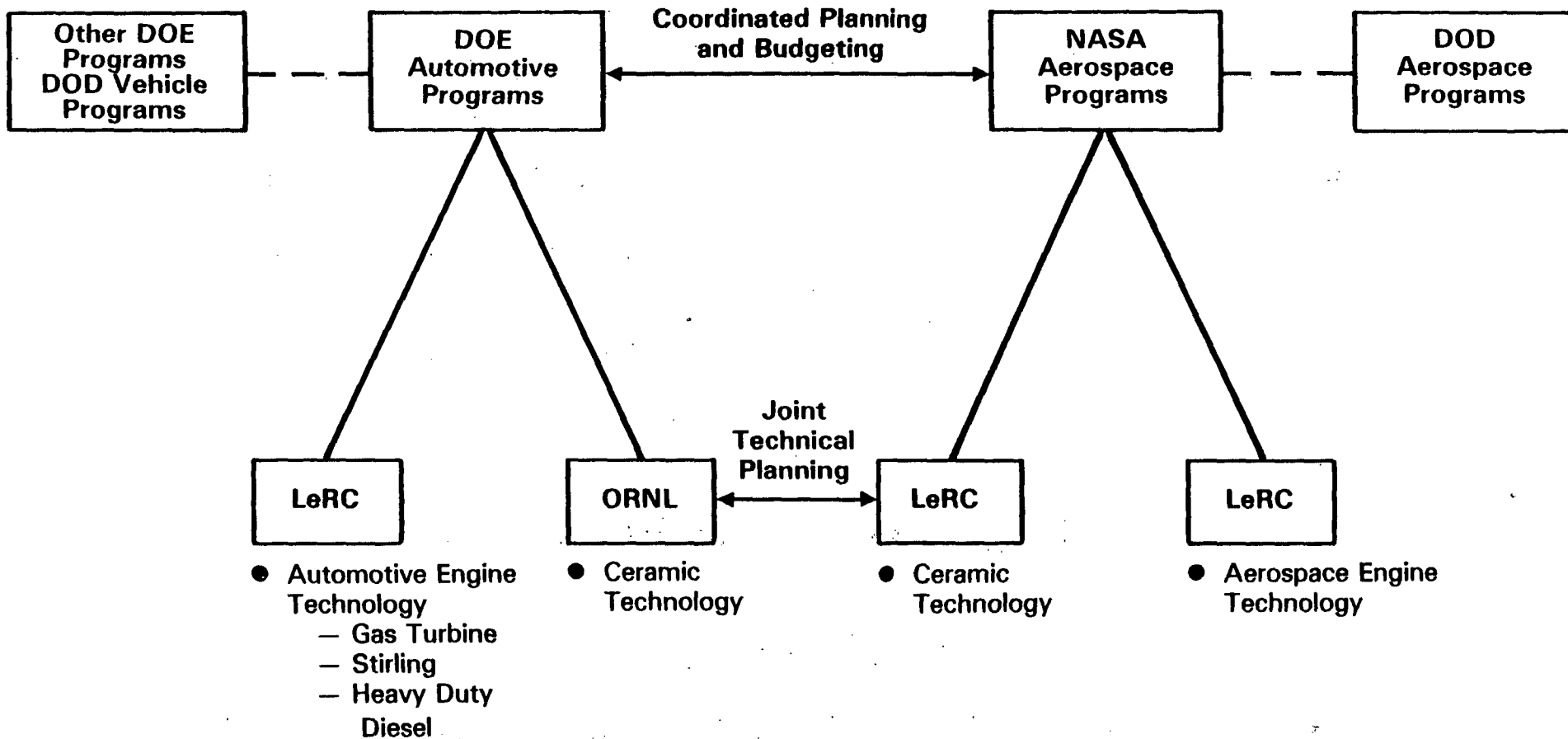

Ceramic Technology For Advanced Heat Engines

Materials/Processing Tasks

- Powder Synthesis and Characterization
- Fiber Synthesis and Characterization
- Processing and Characterization of Green State Ceramics
- Densification
- Ceramic Coating Processing and Characterization
- In-Process and Post-Process Characterization

**Interactive Approach Guided by Microstructure,
Microchemical, and Property Evaluations**

Ceramic Technology For Advanced Heat Engines

Materials/Processing Program Element Objectives and Benefits

- Improve Understanding of Process Parameters Versus Microstructure, Microchemistry, and Critical Properties
- Improve Properties and Reliability of Existing Materials
- Develop New Materials Engineered Specifically For Heat Engine Applications
- Iterative Evaluation of Test Specimen and Simulated Component Fabrication at Each Sub-Process Step

**Major Emphasis In
New Ceramic Technology Program Required**

Ceramic Technology For Advanced Heat Engines

Data Base/Life Prediction Tasks

- **Statistical Property Data Generation to Further Guide Process Development Towards Reliability**
- **Design Data Generation for Component Analysis to Determine Probability of Survival, Life Prediction, Etc.**
- **Fast Fracture, Slow Crack Growth, Fatigue, and Environmental Effects Studies Relevant to the Heat Engine Environment**

Ceramic Technology For Advanced Heat Engines

Design Methodology Tasks

- Analytical/Experimental/Instrumentation Techniques Development, for Determining Boundary Conditions
- Component 3-D Modeling
- Material Modeling, Especially Composites and Powder/Binder Systems
- Interface Modeling
- Crack Initiation and Propagation Modeling, Considering Microstructure/Stress Interactions
- Alternate Statistical Approach Evaluations
- New Design Concept or Approach Development

Ceramic Technology For Advanced Heat Engines

Component Reliability Testing

- Apply Materials/Processing Results to Components For Reliability Testing in Existing Engine-Simulating Test Beds
- Evaluate Advanced NDE Techniques and Proof Testing
- Accomplish Reliability Testing in a Realistic Engine-Simulating Environment
- Conduct Post-Test Evaluation
- Apply Results to Redesign or Material Modification As Required

Currently Being Conducted Under AGT and Diesel Programs

The Expertise and Facilities of Many Organizations Will Be Required to Implement This Program

- Ceramic Industry and Engine Manufacturers
- Industrial Laboratories
- Government Laboratories (DOE, NASA, DOD)
- Universities
- Advisory Board (NMAB or Other Independent Organizations)
- Interface With Other Government and Technical Organizations (DOE/EMACC, Interagency Materials Committee, American Ceramic Society, ASME, IEA, Etc.)

BASIC ENERGY SCIENCES

DIVISION OF MATERIALS SCIENCES

ROBERT J. GOTTSCHALL, DOE

PROGRAM SUMMARIES FOR

- TRANSFORMATION TOUGHENED CERAMICS
- STRUCTURAL CARBIDES
- STRUCTURAL NITRIDES
- CERAMIC POWDER PREPARATION,
CHARACTERIZATION, OR BEHAVIOR
(NON-COMPACTED)
- POWDER CONSOLIDATION INCLUDING
SINTERING, HOT PRESSING, DYNAMIC
COMPACTION, LASER ASSISTED, ETC.

OFFICE OF ENERGY RESEARCH

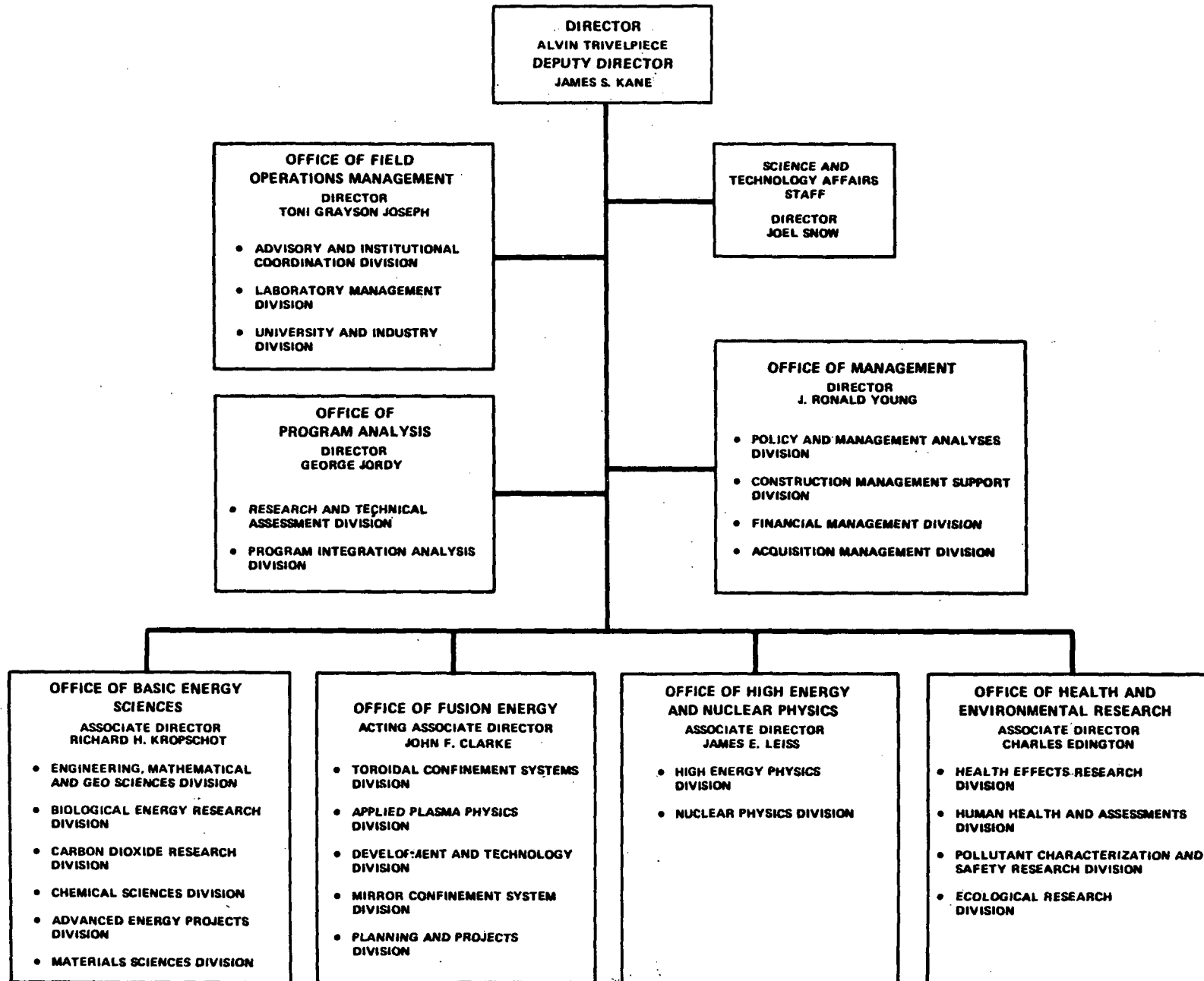

STRUCTURE OF

DIVISION OF MATERIALS SCIENCES

OFFICE OF BASIC ENERGY SCIENCES

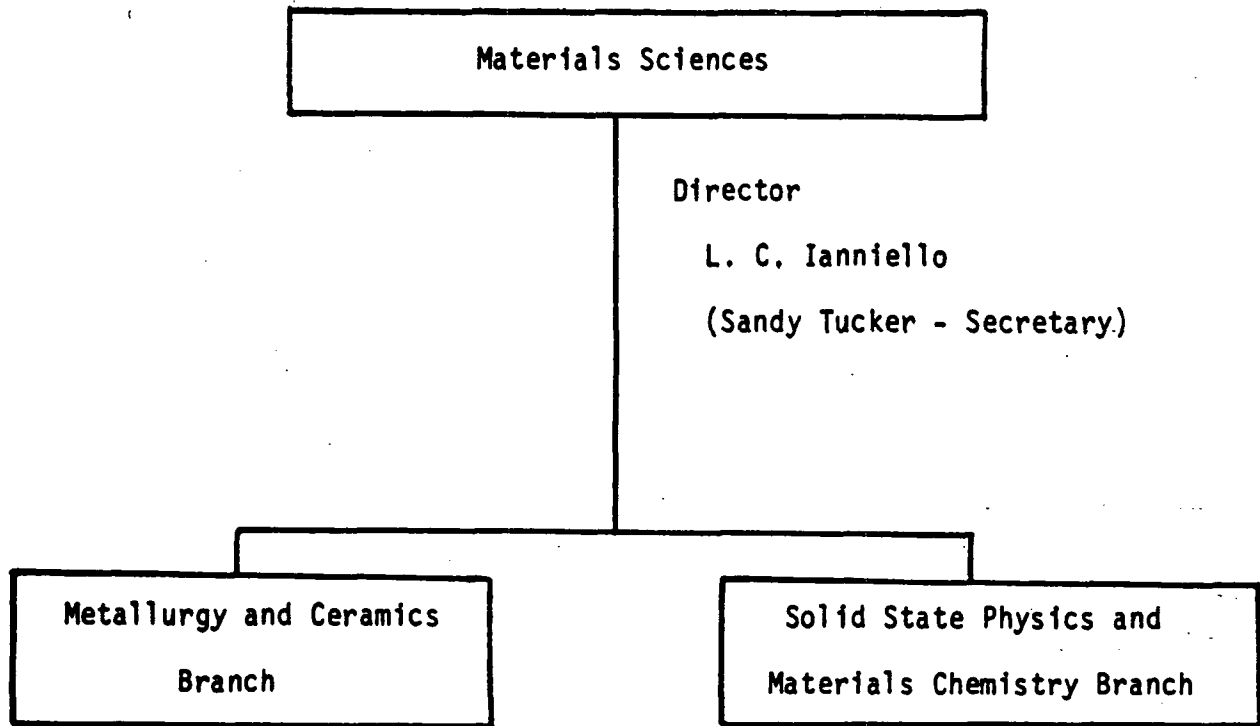

Director

L. C. Ianniello

(Sandy Tucker - Secretary)

Metallurgy and Ceramics
Branch

Solid State Physics and
Materials Chemistry Branch

(Janet Venneri - Secretary)

(Linda Twenty - Secretary)

Chief: Vacant
S. M. Wolf
R. J. Gottschall
D. M. Parkin 1/

Chief: M. C. Wittels
T. A. Kitchens
R. H. Bragg 2/
A. C. Switendick 3/
D. T. Cromer 4/
B. C. Frazer 5/
J. B. Darby, Jr. 6/

Notes: 1/ On Leave from Los Alamos National Laboratory
2/ Returning to Lawrence Berkeley Laboratory 8/82
3/ Returning to Sandia National Laboratories - Albuquerque 8/82
4/ Returning to Los Alamos National Laboratory 8/82
5/ On Leave from Brookhaven National Laboratory, arriving 10/82
6/ On Leave from Argonne National Laboratory, arriving 9/82

STRUCTURAL CERAMICS ARE A CLASS OF COVALENTLY BONDED NON-METALLIC INORGANIC SOLIDS THAT EXHIBIT A TECHNOLOGICALLY SIGNIFICANT FRACTURE TOUGHNESS TO 1500°C. EXAMPLES: SiC , Si_3N_4 , SiALON , SiC-ALN SOLID SOLUTIONS, ETC.

FABRICATION INVOLVES A COALESCENCE OR DENSIFICATION PROCESS. FABRICATION METHODS INCLUDE

- HOT PRESSING
- SINTERING (LIQUID PHASE)
- CHEMICAL VAPOR DEPOSITION, REACTION BONDING
- LASER DRIVEN REACTIONS
- EXPLOSIVE, IMPACT, AND HIGH PRESSURE COMPACTION

PROBLEMS WITH STRUCTURAL CERAMICS

- DESIGN ENGINEER CANNOT MAKE SIMPLE SUBSTITUTION OF CERAMIC FOR METALLIC COMPONENTS, BECAUSE OF BEHAVIORAL DIFFERENCES UNDER MULTIAXIAL (HERTZIAN CONTACT) LOADS, AND DIFFERENT STRAIN-RATE SENSITIVITIES.
- FABRICATION OF COMPONENTS WITH ENGINEERING DIMENSIONS THAT ARE
 - FLAW FREE
 - FULLY DENSE
 - UNIFORM MICROSTRUCTURE (FREE OF POLYTYPISM, ETC.)
 - FREE OF UNDESIRABLE GLASS PHASES, ETC.
- NDE
 - QUALITY CONTROL: MUST DETECT PORES, MICRO-CRACKS, INCLUSIONS
 - PREDICTIVE: EARLY WARNING OF IMPENDING FAILURE
 - STATISTICAL/QUANTITATIVE RELATIONSHIP OF NDE TO MECHANICAL TEST BEHAVIOR

**MATERIALS RESEARCH IMPORTANT TO STRUCTURAL CERAMICS FOR ENERGY,
ESPECIALLY SILICON CONTAINING MATERIALS (E.G. SiC, Si₃N₄)**

POWDER PREPARATION

SINTERING AND HOT PRESSING

THERMAL PROPERTIES

**MECHANICAL PROPERTIES,
ESPECIALLY FRACTURE**

**STRUCTURAL AND MICRO-
STRUCTURAL STUDIES**

**OXIDATION AND OTHER CORROSION
STUDIES**

NONDESTRUCTIVE EVALUATION

**NEUTRON SCATTERING AND
ELECTRON MICROSCOPY**

DIFFUSION AND DEFECT STUDIES

GRAIN BOUNDARY EFFECTS

**MATERIALS TO
OPERATE AT
HIGHER
TEMPERATURES**

**LESS EXPENSIVE
NONSTRATEGIC
MATERIALS**

**HIGHER QUALITY
AND MORE
PREDICTABLY
CONSISTENT
PROPERTIES**

**MATERIALS TO
OPERATE FOR
LONGER TIMES**

**HIGH TEMPERATURE
HEAT EXCHANGERS**

**HIGH TEMPERATURE
TURBINE STRUCTURAL
COMPONENTS**

**POSSIBLE DISPLACEMENT
OF CRITICAL MATERIALS
(E.G. Co)**

**HIGH TEMPERATURE
BEARINGS**

**HIGH TEMPERATURE
VALVES**

FINDING AND RECOMMENDATIONS FOR BASIC RESEARCH IN HIGH TEMPERATURE CERAMICS
FROM CERAMICS PANEL REPORT TO THE COUNCIL ON MATERIALS SCIENCE
OF SEPTEMBER 1978 (COPIES AVAILABLE ON REQUEST):

FINDING

- THE MAJOR AND OVER-RIDING PROBLEM OF HIGH PERFORMANCE CERAMICS IS THAT COMPONENTS WITH DESIRED PROPERTIES AND MICROSTRUCTURE CANNOT BE RELIABLY AND REPRODUCIBLY MANUFACTURED. BECAUSE OF THE LACK OF FUNDAMENTAL UNDERSTANDING THERE IS A CRITICAL NEED FOR BASIC STUDIES ON CERAMIC MICROSTRUCTURE DEVELOPMENT AND CONTROL.

RECOMMENDATIONS AS HIGHEST PRIORITY TOPICS FOR CERAMIC RESEARCH

- INTERPARTICLE FORCES AND MECHANISMS THAT CAUSE PARTICLE AGGLOMERATION.
- PHYSICAL-CHEMICAL CHARACTERISTICS OF SOLID-FLUID INTERFACES.
- RELATIONSHIP OF PARTICLE, FLUID, AND INTERFACIAL FACTORS TO STRUCTURE AND FLOW BEHAVIOR OF SOLID-FLUID SYSTEMS UNDER VARIOUS EXTERNAL FORCES.
- RELATIONSHIP OF KINETICS OF INTERFACE-CONTROLLED REACTIONS TO STRUCTURAL-CHEMICAL PARAMETERS.
- IDENTIFICATION AND RELATIONSHIP OF MICROSTRUCTURAL AND CHEMICAL FACTORS TO ELECTRICAL INSTABILITIES.
- IDENTIFICATION AND QUANTITATIVE UNDERSTANDING OF STRENGTH LIMITING FLAWS AND THEIR RELATIONSHIP TO MECHANICAL STABILITY.
- UNDERSTANDING OF THE PHYSICS OF CRACK PROPAGATION AND HOW IT IS AFFECTED BY MICROSTRUCTURE AND ENVIRONMENT.
- UNDERSTANDING OF THE MECHANISMS OF DEFORMATION IN MULTIPHASE CERAMICS.

TRANSFORMATION TOUGHENED CERAMICS

AMES LABORATORY

ULTRASONIC MEASUREMENTS

\$ 40,000

J. F. Smith, R. B. Thompson

Martensitic transformations in ZrO_2 and HfO_2 are responsible for the sensitivity of these materials to thermal shock. Ultrasonic wave velocities are being measured in yttria stabilized single crystals of ZrO_2 at elevated temperatures to determine the role of the elastic constants in the transformations. Additional measurements of ultrasonic wave velocities are being measured in Nb with (a) unstressed material, (b) stress material, (c) plastically deformed material, and (d) annealed material in an effort to quantitatively determine residual stress levels.

LOS ALAMOS NATIONAL LABORATORY

MECHANICAL PROPERTIES

\$310,000

J. J. Petrovic, M. G. Stout,
K. P. Staudhammer

Multiaxial deformation of aluminum, aluminum alloys, titanium, brass, OFHC copper, and 304 stainless steel; yield surfaces and multiaxial stress-strain relations; stress path changes; large strain deformation; multiaxial ductile fracture; geometric instabilities in tubes and sheet; substructural evolution with strain, strain state and strain rate; brittle fracture of Al_2O_3 , Si_3N_4 , SiC and ZrO_2 under multiaxial stresses; mixed-mode brittle fracture; Weibull statistical fracture theory for multiaxial loading; indentation-produced surface flaws and fracture toughness of ceramics.

OAK RIDGE NATIONAL LABORATORY

MECHANICAL PROPERTIES OF CERAMICS

\$470,000

P. F. Becher, G. W. Clark, M. K. Ferber,
C. J. McHargue, C. S. Yust

Flexure strength, fracture toughness and erosion resistance of TiB_2 as related to microcracking, slow crack growth and microstructure; wear studies of TiB_2 , SiC , Al_2O_3 and transformation-toughened $Al_2O_3-Zr_2O_3$; slow crack growth and in situ electron microscopy studies of transformation-toughened $Al_2O_3-Zr_2O_3$; microhardness, indentation fracture toughness, and flexure strength of ion implanted Al_2O_3 , SiC , and TiB_2 .

RESEARCH IN CERAMIC PROCESSING

\$275,000

P. F. Becher, C. B. Finch, C. J. McHarge

Near-surface modification of Al_2O_3 , SiC , Si_3N_4 , and TiB_2 by ion implantation, structure determination by Rutherford backscattering and TEM, annealing; liquid phase sintering of TiB_2 ; sol gel powder preparation and microstructural control in transformation-toughened $Al_2O_3-Zr_2O_3$ and $Al_2O_3-HfO_2$; crystal growth of β' -sialon and mullite.

STRUCTURAL CARBIDES

UNIVERSITY OF ILLINOIS

STRUCTURE, CRACKING AND CORROSION OF CERAMIC GRAIN BOUNDARIES \$ 75,000

S. D. Brown, W. T. Petuskey and A. Zangvil

Effect of impurities on structure and chemistry of regions contiguous to grain boundaries in SiC and Si₃N₄. Fracture strength toughness, creep and corrosion. Structure of AlN-SiC solid solutions.

LAWRENCE BERKELEY LABORATORY

MECHANICAL PROPERTIES OF CERAMICS \$206,000

A. G. Evans

This project is concerned with the mechanical reliability of ceramics at high temperatures. The principal research emphases are the development of a predictive capability for high-temperature failure and for microstructure development during final-stage sintering. Elevated temperature failure studies are concerned with the evolution of cavities, and cracks at grain boundaries and within second phases. Experimental cavitation measurements are correlated with theoretical models containing the dominant microstructural variables. Final-stage sintering studies are examining the processes that dictate exaggerated grain growth, retained porosity, and the coarsening of the general microstructure. Theoretical descriptions are compared with microstructural measurements.

EROSION OF BRITTLE SOLIDS \$ 70,000

A. G. Evans

This project is concerned with the development of a fundamental understanding of erosion and strength degradation in brittle solids subject to impact by solid particles. The principal research directions involve studies both of the damage created by the impact of individual particles and of the erosion characteristics under multiple impact conditions. The studies are conducted as a function of temperature, velocity, angle of incidence, and projectile hardness in order to identify specific mechanisms of erosion and strength degradation. Predictions of erosion are generated for each important material removal mechanism.

LOS ALAMOS NATIONAL LABORATORY

MECHANICAL PROPERTIES \$310,000

J. J. Petrovic, M. G. Stout,

K. P. Staudhammer

Multiaxial deformation of aluminum, aluminum alloys, titanium, brass, OFHC copper, and 304 stainless steel; yield surfaces and multiaxial stress-strain relations; stress path changes; large strain deformation; multiaxial ductile fracture; geometric instabilities in tubes and sheet; substructural evolution with strain, strain state and strain rate; brittle fracture of Al₂O₃, Si₃N₄, SiC and ZrO₂ under multiaxial stresses; mixed-mode brittle fracture; Weibull statistical fracture theory for multiaxial loading; indentation-produced surface flaws and fracture toughness of ceramics.

STRUCTURAL CERAMICS

\$146,000

J. J. Petrovic, F. D. Gac,
J. V. Milewski, H. Sheinberg,
D. E. Hull, L. R. Newkirk, C. Hollabaugh

Fabrication-microstructure-properties interrelationships for structural ceramics; fabrication of dense SiC and Si₃N₄ materials without the use of densification additives; SiC and Si₃N₄ ultra-fine/ultra-pure powder production by RF-plasma methods; SiC and Si₃N₄ single crystal whisker growth by vapor-liquid-solid (VLS) techniques; powder activation by shock loading and irradiation; hot-pressing and sintering consolidation; relationships between processing and microstructure, mechanical behavior, and oxidation/corrosion response.

OAK RIDGE NATIONAL LABORATORY

MECHANICAL PROPERTIES OF CERAMICS

\$470,000

P. F. Becher, G. W. Clark, M. K. Ferber,
C. J. McHargue, C. S. Yust

Flexure strength, fracture toughness and erosion resistance of TiB₂ as related to microcracking, slow crack growth and microstructure; wear studies of TiB₂, SiC, Al₂O₃ and transformation-toughened Al₂O₃-Zr₂O₃; slow crack growth and in situ electron microscopy studies of transformation-toughened Al₂O₃-Zr₂O₃; microhardness, indentation fracture toughness, and flexure strength of ion implanted Al₂O₃, SiC, and TiB₂.

RESEARCH IN CERAMIC PROCESSING

\$275,000

P. F. Becher, C. B. Finch, C. J. McHarge

Near-surface modification of Al₂O₃, SiC, Si₃N₄, and TiB₂ by ion implantation, structure determination by Rutherford backscattering and TEM, annealing; liquid phase sintering of TiB₂; sol gel powder preparation and microstructural control in transformation-toughened Al₂O₃-Zr₂O₃ and Al₂O₃-HfO₂; crystal growth of β'-sialon and mullite.

BATTELLE COLUMBUS LABORATORIES

FAILURE OF CERAMICS FROM MULTIAXIAL STRESSES

\$142,000

A. A. Rosenfield, D. K. Shetty,
S. G. Sampath, W. H. Duckworth

Understanding of multiaxial stress phenomena on the mechanical behavior of ceramics. Relationship of stress-state effects to stress-intensity factor. Effects of tensile and shear stresses parallel to an artificial crack and effects of stress ratios on strength in ceramic specimens containing natural flaws to evaluate statistical (Weibull) descriptions of strength. Materials preparation and characterization. Fractography. Three dimensional linear elastic finite element analysis of test-specimen geometries and for stress-intensity factors. Biaxial tests of ceramic specimens containing controlled artificial flaws. Al₂O₃, SiC, Si₃N₄, glass-ceramics.

CORNELL UNIVERSITY

INELASTIC DEFORMATION IN NON-METALLIC
CRYSTALLINE SOLIDS

\$ 55,000

D. L. Kohlstedt - Dept. of Materials Science
and Engineering

Liquid-phase hot-pressing and high-temperature deformation of hot-pressed TiC and TiC-VC, and the effects of excess Ti and TiB₂ precipitates on such materials. Densification mechanisms and kinetics. Creep and constant compressive strain rate experiments. TEM-STEM analysis.

DIFFRACTION AND MICROSCOPY STUDIES
OF THE STRUCTURE OF GRAIN BOUNDARIES IN
Fe, Fe-BASE ALLOYS, AND CERAMIC MATERIALS
S. L. Sass - Dept. of Materials Science
and Engineering

\$123,000

Investigation of grain boundary structure in metals, primarily Fe-base alloys, and ceramics--FeO, MgO, NiO, TiC; characterization of boundary periodicity, and dislocation arrays, using TEM imaging as well as electron and X-ray diffraction.

MASSACHUSETTS INSTITUTE OF TECHNOLOGY

BASIC RESEARCH IN CRYSTALLINE
CERAMIC SYSTEMS

\$650,000
(13 months)

W. D. Kingery - Dept. of Materials
Science and Engineering
R. L. Coble - Dept. of Materials
Science and Engineering

Broad program on the science of ceramic materials; MgO used as a model material; electrical, optical, dielectric properties; defect structure, kinetics, sintering and creep studies; ionic conductivity and Mg vacancy mobility of MgO; boron diffusion in SiC; characterization of grain boundary segregation in MgO; sintering of covalent (Si) materials; influence of grain size distributions and grain arrangements on grain boundary diffusion creep; STEM studies of grain boundary composition; hot stage SEM study of microstructure development; rapid quenching of solid ceramic samples; breakaway grain growth in MgO doped Al₂O₃.

EROSION OF STRUCTURAL CERAMICS

\$ 28,130

J. E. Ritter, Jr. - Dept. of Mechanical
Engineering
K. Jakus - Dept. of Mechanical
Engineering

(8½ months)

Erosion behavior and related strength degradation of Al_2O_3 , Si_3N_4 , and SiC to 1200°C. Assessments of erosion models for predicting erosion behavior and associated strength degradation. Effect of eroding particle velocity, size, angle of impingement, temperature of environment, and subcritical crack growth on erosion rate and related strength degradation for Al_2O_3 , SiC, and Si_3N_4 . Biaxial strength characterizations of as-prepared and eroded samples.

CITY UNIVERSITY OF NEW YORK/CITY COLLEGE

STUDY OF THE FORMATION OF SURFACE FILMS:
CRITICAL CONDITIONS FOR GROWTH
F. W. Smith - Dept. of Physics

\$ 60,000

Critical conditions for chemical vapor deposition growth of films of SiC, Si_3N_4 , and SiO_2 on single crystal Si substrates are studied under ultrahigh vacuum conditions, and the high temperature interactions of C_2H_2 , C_2H_4 , CH_4 , CO, NH_3 , N_2 , NO, O_2 , and H_2O with clean (111) and (100) surfaces of Si are investigated. Oxide, carbide, silicide film formation on polycrystalline W, Mo, and Ta substrates are studied with partial pressure of reactants and substrate temperature as controlled variables. Growth of silicon homo-epitaxial films formed via the reaction of SiH_4 with Si (111) and (100). Analytical techniques include Auger electron spectroscopy, X-ray diffraction, scanning electron microscopy, transmission electron microscopy.

STRUCTURAL NITRIDES

UNIVERSITY OF ILLINOIS

STRUCTURE, CRACKING AND CORROSION OF CERAMIC GRAIN BOUNDARIES

\$ 75,000

S. D. Brown, W. T. Petuskey and A. Zangvil

Effect of impurities on structure and chemistry of regions contiguous to grain boundaries in SiC and Si₃N₄. Fracture strength toughness, creep and corrosion. Structure of AlN-SiC solid solutions.

LAWRENCE BERKELEY LABORATORY

MECHANICAL PROPERTIES OF CERAMICS A. G. Evans

\$206,000

This project is concerned with the mechanical reliability of ceramics at high temperatures. The principal research emphases are the development of a predictive capability for high-temperature failure and for microstructure development during final-stage sintering. Elevated temperature failure studies are concerned with the evolution of cavities, and cracks at grain boundaries and within second phases. Experimental cavitation measurements are correlated with theoretical models containing the dominant microstructural variables. Final-stage sintering studies are examining the processes that dictate exaggerated grain growth, retained porosity, and the coarsening of the general microstructure. Theoretical descriptions are compared with microstructural measurements.

EROSION OF BRITTLE SOLIDS A. G. Evans

\$ 70,000

This project is concerned with the development of a fundamental understanding of erosion and strength degradation in brittle solids subject to impact by solid particles. The principal research directions involve studies both of the damage created by the impact of individual particles and of the erosion characteristics under multiple impact conditions. The studies are conducted as a function of temperature, velocity, angle of incidence, and projectile hardness in order to identify specific mechanisms of erosion and strength degradation. Predictions of erosion are generated for each important material removal mechanism.

LOS ALAMOS NATIONAL LABORATORY

MECHANICAL PROPERTIES J. J. Petrovic, M. G. Stout, K. P. Staudhammer

\$310,000

Multiaxial deformation of aluminum, aluminum alloys, titanium, brass, OFHC copper, and 304 stainless steel; yield surfaces and multiaxial stress-strain relations; stress path changes; large strain deformation; multiaxial ductile fracture; geometric instabilities in tubes and sheet; substructural evolution with strain, strain state and strain rate; brittle fracture of Al₂O₃, Si₃N₄, SiC and ZrO₂ under multiaxial stresses; mixed-mode brittle fracture; Weibull statistical fracture theory for multiaxial loading; indentation-produced surface flaws and fracture toughness of ceramics.

STRUCTURAL CERAMICS

\$146,000

J. J. Petrovic, F. D. Gac,
J. V. Milewski, H. Sheinberg,
D. E. Hull, L. R. Newkirk, C. Hollabaugh

Fabrication-microstructure-properties interrelationships for structural ceramics; fabrication of dense SiC and Si₃N₄ materials without the use of densification additives; SiC and Si₃N₄ ultra-fine/ultra-pure powder production by RF-plasma methods; SiC and Si₃N₄ single crystal whisker growth by vapor-liquid-solid (VLS) techniques; powder activation by shock loading and irradiation; hot-pressing and sintering consolidation; relationships between processing and microstructure, mechanical behavior, and oxidation/corrosion response.

OAK RIDGE NATIONAL LABORATORY

RESEARCH IN CERAMIC PROCESSING

\$275,000

P. F. Becher, C. B. Finch, C. J. McHarge

Near-surface modification of Al₂O₃, SiC, Si₃N₄, and TiB₂ by ion implantation, structure determination by Rutherford backscattering and TEM, annealing; liquid phase sintering of TiB₂; sol gel powder preparation and microstructural control in transformation-toughened Al₂O₃-Zr₂O₃ and Al₂O₃-HfO₂; crystal growth of β'-sialon and mullite.

BATTELLE COLUMBUS LABORATORIES

FAILURE OF CERAMICS FROM MULTIAXIAL STRESSES

\$142,000

A. A. Rosenfield, D. K. Shetty,
S. G. Sampath, W. H. Duckworth

Understanding of multiaxial stress phenomena on the mechanical behavior of ceramics. Relationship of stress-state effects to stress-intensity factor. Effects of tensile and shear stresses parallel to an artificial crack and effects of stress ratios on strength in ceramic specimens containing natural flaws to evaluate statistical (Weibull) descriptions of strength. Materials preparation and characterization. Fractography. Three dimensional linear elastic finite element analysis of test-specimen geometries and for stress-intensity factors. Biaxial tests of ceramic specimens containing controlled artificial flaws. Al₂O₃, SiC, Si₃N₄, glass-ceramics.

CORNELL UNIVERSITY

HIGH TEMPERATURE MECHANICAL
BEHAVIOR OF SILICON NITRIDE

\$117,000
(17 months)

R. Raj - Dept. of Materials Science
and Engineering

Creep cavitation in ceramics under multiaxial loading and densification mechanisms in ceramics in the hot isostatic pressing process. In-situ measurements of densification rate of powder compacts under a variable confining pressure.

MASSACHUSETTS INSTITUTE OF TECHNOLOGY

EROSION OF STRUCTURAL CERAMICS

\$ 28,130
(8½ months)

J. E. Ritter, Jr. - Dept. of Mechanical
Engineering
K. Jakus - Dept. of Mechanical
Engineering

Erosion behavior and related strength degradation of Al_2O_3 , Si_3N_4 , and SiC to 1200°C. Assessments of erosion models for predicting erosion behavior and associated strength degradation. Effect of eroding particle velocity, size, angle of impingement, temperature of environment, and subcritical crack growth on erosion rate and related strength degradation for Al_2O_3 , SiC, and Si_3N_4 . Biaxial strength characterizations of as-prepared and eroded samples.

UNIVERSITY OF MICHIGAN

EFFECT OF CRYSTALLIZATION OF GRAIN
BOUNDARY PHASE ON THE HIGH TEMPERATURE
STRENGTH OF SILICON NITRIDE CERAMICS

\$ 64,597

T. Y. Tien - Dept. of Materials
and Metallurgical Engineering

Study of role and mechanism of nucleating agents on the crystallization of the Si_2N_2O containing grain boundary phases which are formed during the processing of Si_3N_4 (containing Y_2O_3 and Al_2O_3) and SIALON ceramics. Microstructure and phase identification in sintered and hot pressed specimens. X-ray diffraction, scanning transmission electron microscopy, electron energy loss spectroscopy, fractography analysis.

CITY UNIVERSITY OF NEW YORK/CITY COLLEGE

STUDY OF THE FORMATION OF SURFACE FILMS: \$ 60,000
CRITICAL CONDITIONS FOR GROWTH
F. W. Smith - Dept. of Physics

Critical conditions for chemical vapor deposition growth of films of SiC, Si₃N₄, and SiO₂ on single crystal Si substrates are studied under ultrahigh vacuum conditions, and the high temperature interactions of C₂H₂, C₂H₄, CH₄, CO, NH₃, N₂, NO, O₂, and H₂O with clean (111) and (100) surfaces of Si are investigated. Oxide, carbide, silicide film formation on polycrystalline W, Mo, and Ta substrates are studied with partial pressure of reactants and substrate temperature as controlled variables. Growth of silicon homo-epitaxial films formed via the reaction of SiH₄ with Si (111) and (100). Analytical techniques include Auger electron spectroscopy, X-ray diffraction, scanning electron microscopy, transmission electron microscopy.

ROCKWELL INTERNATIONAL SCIENCE CENTER

SINTERING PHENOMENA OF NON-OXIDE \$108,025
SILICON COMPOUNDS
D. R. Clarke, F. F. Lange

Investigation of parameters affecting powder consolidation and sintering that lead to microstructural inhomogeneities in Si₃N₄ based alloys. Non-aqueous electrolytic dispersion of Si₃N₄ powders and the establishment of zeta potential conditions for their optimum dispersion. Selection procedures for narrow powder size dispersions. Packing uniformity and porosity distribution of consolidated casts and their relationship to properties of the parent colloidal suspension. Raman microprobe spectroscopy and STEM and analytical electron microscopy. Electron energy loss spectroscopy in collaboration with N. J. Zaluzec at ANL.

CERAMIC POWDER PREPARATION, CHARACTERIZATION, OR BEHAVIOR
(NON-COMPACTED)

AMES LABORATORY

CERAMIC PROCESSING \$135,000
M. Akinc, M. D. Rasmussen

Influence of preparative procedures on characteristics of precursors and resulting oxides. Surface electrochemical properties of precipitated particles in the aqueous media. Effect of drying methods (oven drying, spray drying, freeze drying, acetone-toluene-acetone drying) on the state of agglomeration. Surface physical and chemical characterization of the precursors, powder morphology sinterability.

PARTICULATE PROCESSING \$275,000
L. E. Burkhart, A. Cahill

Transport near interfaces, especially drops, bubbles, and solid particles; kinetics and control of particle size distribution, growth rate, and morphology in both liquid phase and vapor phase operations involving the preparation of ceramic powders (yttria, urania, titania); reaction kinetics and mixing in multicomponent mass transfer systems involving chemical reactions with emphasis on correlation between theory and experiment (metal recovery processes).

UNIVERSITY OF ILLINOIS

SOLID DIELECTRICS \$ 95,000
D. A. Payne

STEM, Auger and SIMS analysis of boundary conditions in electrical ceramics, flux growth of ferroelectric crystals; powder preparation by molten salt synthesis and hydrothermal methods. Dielectrophoretic alignment of particles hot-forging and hot-extrusion of ceramic microstructures. Fabrication of heterostructure electrodes for the photoassisted electrolysis of water.

LAWRENCE BERKELEY LABORATORY

MECHANICAL PROPERTIES OF CERAMICS \$206,000
A. G. Evans

This project is concerned with the mechanical reliability of ceramics at high temperatures. The principal research emphases are the development of a predictive capability for high-temperature failure and for microstructure development during final-stage sintering. Elevated temperature failure studies are concerned with the evolution of cavities, and cracks at grain boundaries and within second phases. Experimental cavitation measurements are correlated with theoretical models containing the dominant microstructural variables. Final-stage sintering studies are examining the processes that dictate exaggerated grain growth, retained porosity, and the coarsening of the general microstructure. Theoretical descriptions are compared with microstructural measurements.

INTERFACES AND CERAMIC MICROSTRUCTURES

\$ 10,000

J. A. Pask

Kinetics and mechanisms of solid-state reactions, nucleation and growth phenomena, and distribution of phases in multiphase ceramic systems whose principal phase constituents are within the $Al_2O_3-SiO_2$ system. Thermodynamic considerations of sintering with a liquid phase. Mechanisms of corrosion of ceramic materials. Thermodynamics and kinetics of electrochemical reactions at glass-metal interfaces.

LOS ALAMOS NATIONAL LABORATORY

STRUCTURAL CERAMICS

\$146,000

J. J. Petrovic, F. D. Gac,
J. V. Milewski, H. Sheinberg,
D. E. Hull, L. R. Newkirk, C. Hollabaugh

Fabrication-microstructure-properties interrelationships for structural ceramics; fabrication of dense SiC and Si_3N_4 materials without the use of densification additives; SiC and Si_3N_4 ultra-fine/ultra-pure powder production by RF-plasma methods; SiC and Si_3N_4 single crystal whisker growth by vapor-liquid-solid (VLS) techniques; powder activation by shock loading and irradiation; hot-pressing and sintering consolidation; relationships between processing and microstructure, mechanical behavior, and oxidation/corrosion response.

OAK RIDGE NATIONAL LABORATORY

RADIOACTIVE WASTE STORAGE

\$420,000

L. A. Boatner, M. M. Abraham,
S. C. Corbato, M. Petek,
B. C. Sales

Research and development relating to use of synthetic analogs of monazite forms for disposal of commercial, U.S. defense, and transuranic wastes; growth of actinide-doped single crystals of monazites and of phases present in other nuclear waste forms (e.g., perovskite $CaTiO_3$, zircon $ZrSiO_4$); determination of valence states and site symmetries of actinide and other impurities using electron paramagnetic resonance, x-ray, optical, and Mössbauer techniques; leaching of radioactive ions from orthophosphates and borosilicate glass under various conditions; use of molten urea process for production of orthophosphate powders with controlled particle sizes; compaction and microstructural characterization of hot-pressed or cold-pressed, sintered orthophosphate bodies; studies of heavy-particle-induced radiation effects in lanthanide orthophosphate compounds; investigations of mechanisms of borosilicate glass corrosion using Rutherford backscattering depth profiling and other surface analytical techniques.

RESEARCH AND DEVELOPMENT - ISOTOPE
RESEARCH MATERIALS PREPARATION

\$300,000

E. H. Kobisk, W. S. Aaron,
H. L. Adair, T. C. Quinby,
R. D. Taylor

Research and development in preparation techniques involved with isotope-containing samples in the form of ultra-thin films (supported and self-supported), wires, rods, cast shapes, alloys, ceramics, cermets, distilled metals, inorganic and refractory compounds, matrix-dispersed materials, and liquids; techniques of preparation include vapor deposition, ion sputtering, rolling, chemical vapor deposition, liquid phase and conventional sintering, hot pressing, isostatic pressing, electrodeposition, molecular plating, zone refining, reactive and ordinary spray calcination, inorganic chemical methods; characterization of prepared research samples includes x-ray and electron diffraction, electron microscopy (TEM and SEM), microprobe studies, differential thermal analysis, thermal conductivity determinations, resonating crystal thickness monitoring, x-ray fluorescence, radiation counting (low geometry and absolute), and microweighing; phase diagram determinations for compounds and metals; all development efforts equivalent for stable and light and heavy radioactive materials.

HIGH TEMPERATURE CHEMISTRY
AND THERMODYNAMICS OF
STRUCTURAL MATERIALS

\$620,000

C. E. Bamberger, J. Brynstad,
G. M. Begun, C. E. Vallet

High temperature materials of importance scientifically and technically are synthesized and characterized by new approaches: for example, titanium diboride, TiB_2 , is being synthesized by homogeneous nucleation from several gaseous phases under various controlled conditions and commercial products are being purified by reaction with gaseous BCl_3 . Studies have been completed of selected microphases in high temperature steels. The stabilities and structures of carbides, Fe-Cr binaries, and other microphases were determined by x-ray diffraction using synchrotron radiation and other applicable techniques; also, studies have been completed of synthetic monazites and monazite-type solid solutions of potential interest in nuclear waste immobilization. coprecipitation of Bi(III) and Ce(IV) by phosphate yielded, after ignition, monazite-type solid solutions identifiable by Raman spectroscopy.

MASSACHUSETTS INSTITUTE OF TECHNOLOGY

INTERFACIAL AND COLLOIDAL ASPECTS
OF AQUEOUS SUSPENSIONS CONTAINING
OXIDIC POWDERS

\$ 95,000
(15½ months)

A. Bleier - Dept. of Materials Science
and Engineering

Application of colloid-chemical models of single and multimetallic oxides to the processing of their powders. Extension of such models to heterogeneous systems containing more than one particle (composition) type, so as to improve understanding of interfacial complexation and related phenomena which influence dispersibility and packing behavior. Objectives include preparation of model, colloid single and multimetallic oxides using established synthesis routes, characterization of these oxides using crystallographic, chemical, physical, and surface-chemical procedures, and evaluation of the Davis, James and Leckie model of the electrical double layer.

PHYSICS AND CHEMISTRY OF PACKING
FINE CERAMIC POWDERS

\$105,000

H. K. Bowen - Dept. of Materials Science
and Engineering

Application of synthesis aspects of colloid chemistry, mono-sized particulates, and paradigms for sintering to develop a scientific understanding for controlling green density. Ordered packing of monodispersed SiO_2 . Sintering of ordered TiO_2 particle compacts. Theoretical models for ordered dispersions and ordered compacts. Dispersion, packing, and sintering of SiO_2 .

PENNSYLVANIA STATE UNIVERSITY

LASER PROCESSING OF CERAMICS

\$ 97,000
(18 months)

G. L. Messing - Dept. of Materials
Science and Engineering

Studies of single component, multicomponent, and decomposition-reaction laser-particle interactions in fine-particle ceramics. Use of a 10.6 micron CO_2 laser to effect calcination without aggregation, morphological modification of particles, and comminution. Thermodynamic and kinetic assessment of effects of rapid heating on processes in fine-particle ceramics, with concerns for potential melting, metamictization, vaporization, and micro-cracking phenomena. Initial studies will be on Al_2O_3 and MgO particles and their precursors.

RENSSELAER POLYTECHNIC INSTITUTE

EXPERIMENTAL TESTS TO UNIFY
SINTERING THEORY

\$ 94,300

R. H. Doremus - Dept. of Materials
Engineering

R. M. German - Dept. of Materials
Engineering

Critical assessment of sintering theories. Measurements of particle, grain, and pore size and shape, shrinkage, surface area, and neck size during the sintering of sodium chloride, aluminum oxide, and aluminum-chromium oxide. Measurements and experimental techniques include dilatometry, buoyancy for density, scanning and transmission electron microscopy, X-ray line broadening, mercury porosimetry, and BET surface adsorption.

ROCKWELL INTERNATIONAL SCIENCE CENTER

SINTERING PHENOMENA OF NON-OXIDE
SILICON COMPOUNDS

\$108,025

D. R. Clarke, F. F. Lange

Investigation of parameters affecting powder consolidation and sintering that lead to microstructural inhomogeneities in Si_3N_4 based alloys. Non-aqueous electrolytic dispersion of Si_3N_4 powders and the establishment of zeta potential conditions for their optimum dispersion. Selection procedures for narrow powder size dispersions. Packing uniformity and porosity distribution of consolidated casts and their relationship to properties of the parent colloidal suspension. Raman microprobe spectroscopy and STEM and analytical electron microscopy. Electron energy loss spectroscopy in collaboration with N. J. Zaluzec at ANL.

POWDER CONSOLIDATION INCLUDING SINTERING, HOT PRESSING,
DYNAMIC COMPACTION, LASER ASSISTED, ETC.

AMES LABORATORY

CERAMIC PROCESSING \$135,000
M. Akinc, M. D. Rasmussen

Influence of preparative procedures on characteristics of precursors and resulting oxides. Surface electrochemical properties of precipitated particles in the aqueous media. Effect of drying methods (oven drying, spray drying, freeze drying, acetone-toluene-acetone drying) on the state of agglomeration. Surface physical and chemical characterization of the precursors, powder morphology sinterability.

UNIVERSITY OF ILLINOIS

RAPID SOLIDIFICATION PROCESSING \$135,000
H. L. Fraser

Development of rapid solidification processing of alloys with powder preparation by laser, spin and centrifugal atomization and subsequent consolidation by dynamic compaction techniques. Characterization of microstructure and measurement of properties developed by heat treatments.

GRAIN GROWTH IN ALUMINA \$ 60,000
D. S. Phillips

Transmission and analytical electron microscopy; characterization of grain boundaries in aluminas, solid state and liquid-phase sintered. Correlation of boundary mobilities with these microstructures in annealed thin films.

SOLID DIELECTRICS \$ 95,000
D. A. Payne

STEM, Auger and SIMS analysis of boundary conditions in electrical ceramics, flux growth of ferroelectric crystals; powder preparation by molten salt synthesis and hydrothermal methods. Dielectrophoretic alignment of particles, hot-forging and hot-extrusion of ceramic microstructures. Fabrication of heterostructure electrodes for the photoassisted electrolysis of water.

LAWRENCE BERKELEY LABORATORY

MECHANICAL PROPERTIES OF CERAMICS

\$206,000

A. G. Evans

This project is concerned with the mechanical reliability of ceramics at high temperatures. The principal research emphases are the development of a predictive capability for high-temperature failure and for microstructure development during final-stage sintering. Elevated temperature failure studies are concerned with the evolution of cavities, and cracks at grain boundaries and within second phases. Experimental cavitation measurements are correlated with theoretical models containing the dominant microstructural variables. Final-stage sintering studies are examining the processes that dictate exaggerated grain growth, retained porosity, and the coarsening of the general microstructure. Theoretical descriptions are compared with microstructural measurements.

INTERFACES AND CERAMIC MICROSTRUCTURES

\$ 10,000

J. A. Pask

Kinetics and mechanisms of solid-state reactions, nucleation and growth phenomena, and distribution of phases in multiphase ceramic systems whose principal phase constituents are within the $Al_2O_3-SiO_2$ system. Thermodynamic considerations of sintering with a liquid phase. Mechanisms of corrosion of ceramic materials. Thermodynamics and kinetics of electrochemical reactions at glass-metal interfaces.

PROPERTIES AND PROCESSING OF
REFRACTORY CERAMICS

\$195,000

L. C. De Jonghe

Mechanisms and kinetics of the reduction of mixed oxides by hydrogen or CO/CO_2 and study of these reactions by thermogravimetry and microanalytical and electron-optical methods. Densification and reaction in Al_2O_3-CaO powder mixtures; modeling and experiments on multiparticle sintering; densification with loading. Liquid phase and transient liquid phase densification.

CERAMIC INTERFACES

\$ 50,000

A. M. Glaeser

Investigation of grain boundary migration behavior and its effect on microstructure development and stability in high-temperature oxide ceramics. Development and refinement of experimental techniques permitting the influence of solutes, pores, etc., on grain boundary migration rates to be isolated and systematically investigated. Determination of the influence of MgO content, driving force, and temperature on migration behavior of individual grain boundaries in Al_2O_3 .

LOS ALAMOS NATIONAL LABORATORY

STRUCTURAL CERAMICS

\$146,000

J. J. Petrovic, F. D. Gac,
J. V. Milewski, H. Sheinberg,
D. E. Hull, L. R. Newkirk, C. Hollabaugh

Fabrication-microstructure-properties interrelationships for structural ceramics; fabrication of dense SiC and Si₃N₄ materials without the use of densification additives; SiC and Si₃N₄ ultra-fine/ultra-pure powder production by RF-plasma methods; SiC and Si₃N₄ single crystal whisker growth by vapor-liquid-solid (VLS) techniques; powder activation by shock loading and irradiation; hot-pressing and sintering consolidation; relationships between processing and microstructure, mechanical behavior, and oxidation/corrosion response.

OAK RIDGE NATIONAL LABORATORY

RESEARCH AND DEVELOPMENT - ISOTOPE
RESEARCH MATERIALS PREPARATION

\$300,000

E. H. Kobisk, W. S. Aaron,
H. L. Adair, T. C. Quinby,
R. D. Taylor

Research and development in preparation techniques involved with isotope-containing samples in the form of ultra-thin films (supported and self-supported), wires, rods, cast shapes, alloys, ceramics, cermets, distilled metals, inorganic and refractory compounds, matrix-dispersed materials, and liquids; techniques of preparation include vapor deposition, ion sputtering, rolling, chemical vapor deposition, liquid phase and conventional sintering, hot pressing, isostatic pressing, electrodeposition, molecular plating, zone refining, reactive and ordinary spray calcination, inorganic chemical methods; characterization of prepared research samples includes x-ray and electron diffraction, electron microscopy (TEM and SEM), microprobe studies, differential thermal analysis, thermal conductivity determinations, resonating crystal thickness monitoring, x-ray fluorescence, radiation counting (low geometry and absolute), and microweighing; phase diagram determinations for compounds and metals; all development efforts equivalent for stable and light and heavy radioactive materials.

UNIVERSITY OF CALIFORNIA/DAVIS

AN INVESTIGATION OF THE ROLE OF
SINTERING IN GAS-SOLID INTERACTIONS
Z. A. Munir - Dept. of Mechanical
Engineering

\$ 66,572
(13 months)

Investigation of the role of sintering in the kinetics of gas-solid interactions in powder compacts, including both oxidation-reduction and dissociation reactions. Morphological changes such as surface area, pore size, and overall porosity are measured and related to changes in the reversibility and rates of reactions. The role of sintering is elucidated by thermogravimetric, microscopy, and surface area measurement techniques. Materials systems under investigation include Pd/PdO, Fe/FeO, and dissociation reactions of carbonates and hydroxides.

CORNELL UNIVERSITY

INELASTIC DEFORMATION IN NON-
METALLIC CRYSTALLINE SOLIDS
D. L. Kohlstedt - Dept. of Materials
Science and Engineering

\$ 55,000

Liquid-phase, hot-pressing and high-temperature deformation of hot-pressed TiC and TiC-VC, and the effects of excess Ti and TiB₂ precipitates on such materials. Densification mechanisms and kinetics. Creep and constant compressive strain rate experiments. TEM-STEM analysis.

HIGH TEMPERATURE MECHANICAL
BEHAVIOR OF SILICON NITRIDE
R. Raj - Dept. of Materials Science
and Engineering

\$117,000
(17 months)

Creep cavitation in ceramics under multiaxial loading and densification mechanisms in ceramics in the hot isostatic pressing process. In-situ measurements of densification rate of powder compacts under a variable confining pressure.

MASSACHUSETTS INSTITUTE OF TECHNOLOGY

INTERFACIAL AND COLLOIDAL ASPECTS
OF AQUEOUS SUSPENSIONS CONTAINING
OXIDIC POWDERS
A. Bleier - Dept. of Materials Science
and Engineering

\$ 95,000
(15½ months)

Application of colloid-chemical models of single and multimetallic oxides to the processing of their powders. Extension of such models to heterogeneous systems containing more than one particle (composition) type, so as to improve understanding of interfacial complexation and related phenomena which influence dispersibility and packing behavior. Objectives include preparation of model, colloid single and multimetallic oxides using established synthesis routes, characterization of these oxides using crystallographic, chemical, physical, and surface-chemical procedures, and evaluation of the Davis, James and Leckie model of the electrical double layer.

PHYSICS AND CHEMISTRY OF
PACKING FINE CERAMIC POWDERS

\$105,000

H. K. Bowen - Dept. of Materials Science
and Engineering

Application of synthesis aspects of colloid chemistry, mono-sized particulates, and paradigms for sintering to develop a scientific understanding for controlling green density. Ordered packing of monodispersed SiO_2 . Sintering of ordered TiO_2 particle compacts. Theoretical models for ordered dispersions and ordered compacts. Dispersion, packing, and sintering of SiO_2 .

BASIC RESEARCH IN CRYSTALLINE
CERAMIC SYSTEMS

\$650,000

W. D. Kingery - Dept. of Materials
Science and Engineering
R. L. Coble - Dept. of Materials
Science and Engineering

Broad program on the science of ceramic materials; MgO used as a model material; electrical, optical, dielectric properties; defect structure, kinetics, sintering and creep studies; ionic conductivity and Mg vacancy mobility in MgO ; boron diffusion in SiC ; characterization of grain boundary segregation in MgO ; sintering of covalent (Si) materials; influence of grain size distributions and grain arrangements on grain boundary diffusion creep; STEM studies of grain boundary composition; hot stage SEM study of microstructure development; rapid quenching of solid ceramic samples; breakaway grain growth in MgO doped Al_2O_3 .

UNIVERSITY OF MICHIGAN

EFFECT OF CRYSTALLIZATION OF
GRAIN BOUNDARY PHASE ON THE HIGH
TEMPERATURE STRENGTH OF SILICON
NITRIDE CERAMICS

\$ 64,597

T. Y. Tien - Dept. of Materials
and Metallurgical Engineering

Study of role and mechanism of nucleating agents on the crystallization of the $\text{Si}_2\text{N}_2\text{O}$ containing grain boundary phases which are formed during the processing of Si_3N_4 (containing Y_2O_3 and Al_2O_3) and SIALON ceramics. Microstructure and phase identification in sintered and hot pressed specimens. X-ray diffraction, scanning transmission electron microscopy, electron energy loss spectroscopy, fractography analysis.

PENNSYLVANIA STATE UNIVERSITY

LASER PROCESSING OF CERAMICS

G. L. Messing - Dept. of Materials
Science and Engineering

\$ 97,000
(18 months)

Studies of single component, multicomponent, and decomposition-reaction laser-particle interactions in fine-particle ceramics. Use of a 10.6 micron CO₂ laser to effect calcination without aggregation, morphological modification of particles, and comminution. Thermodynamic and kinetic assessment of effects of rapid heating on processes in fine-particle ceramics, with concerns for potential melting, metamictization, vaporization, and microcracking phenomena. Initial studies will be on Al₂O₃ and MgO particles and their precursors.

RENSSELAER POLYTECHNIC INSTITUTE

EXPERIMENTAL TESTS TO UNIFY
SINTERING THEORY

R. H. Doremus - Dept. of Materials
Engineering

R. M. German - Dept. of Materials
Engineering

\$ 94,300

Critical assessment of sintering theories. Measurements of particle, grain, and pore size and shape, shrinkage, surface area, and neck size during the sintering of sodium chloride, aluminum oxide, and aluminum-chromium oxide. Measurements and experimental techniques include dilatometry, buoyancy for density, scanning and transmission electron microscopy, X-ray line broadening, mercury porosimetry, and BET surface adsorption.

ROCKWELL INTERNATIONAL SCIENCE CENTER

SINTERING PHENOMENA OF NON-
OXIDE SILICON COMPOUNDS

D. R. Clarke, F. F. Lange

\$108,025

Investigation of parameters affecting powder consolidation and sintering that lead to microstructural inhomogeneities in Si₃N₄ based alloys. Non-aqueous electrolytic dispersion of Si₃N₄ powders and the establishment of zeta potential conditions for their optimum dispersion. Selection procedures for narrow powder size dispersions. Packing uniformity and porosity distribution of consolidated casts and their relationship to properties of the parent colloidal suspension. Raman microprobe spectroscopy and STEM and analytical electron microscopy. Electron energy loss spectroscopy in collaboration with N. J. Zaluzec at ANL.

OVERVIEW OF DOD
CERAMIC HEAT ENGINE TECHNOLOGY PROJECTS

DR. EDWARD M. LENOE
ARMY MATERIALS AND MECHANICS
RESEARCH CENTER

**OVERVIEW OF DOD
CERAMIC HEAT ENGINE TECHNOLOGY PROJECTS**

DR. EDWARD M. LENOE

Structural Ceramics for Heat Engines

DISTRIBUTION OF U.S. GOVERNMENT FUNDED R&D FY 1981

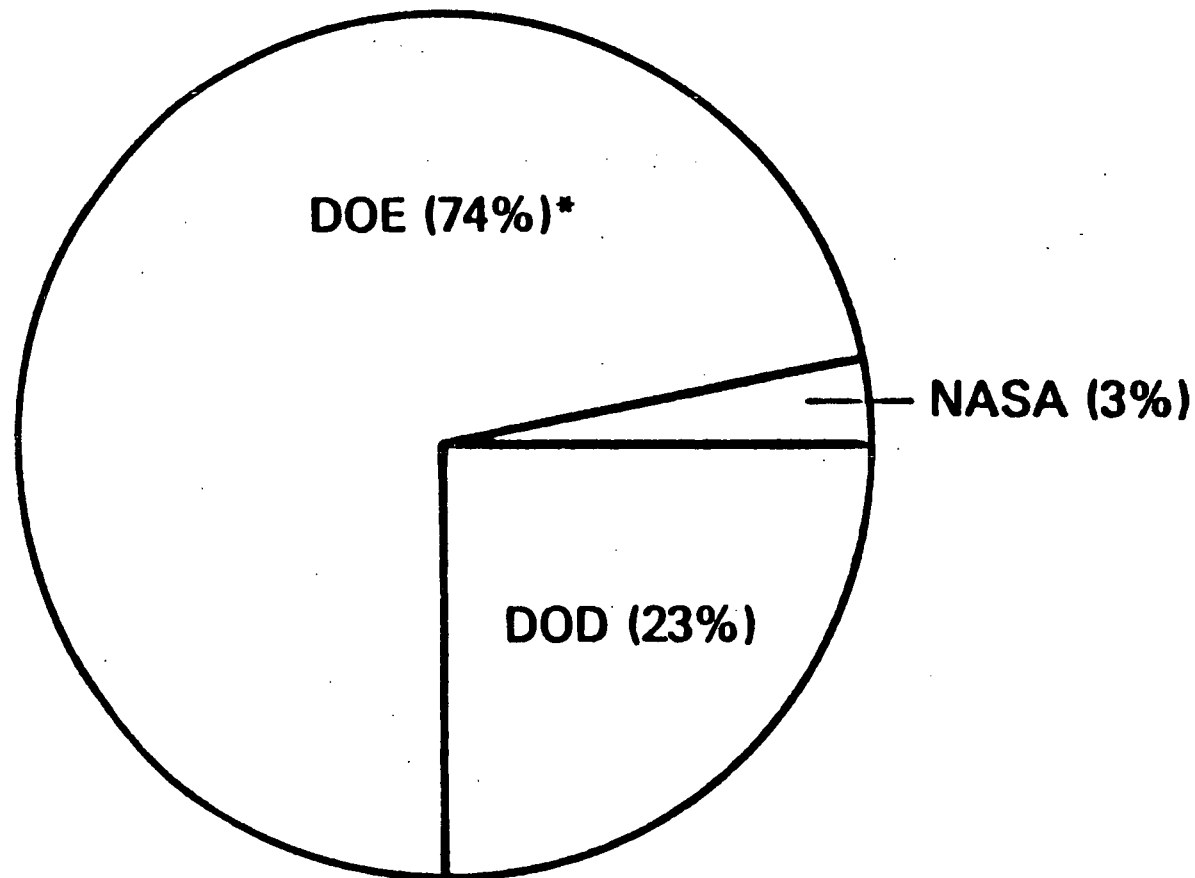

* DOE Automotive Gas Turbine Project (61%)

DOE Vehicle Propulsion R&D Program is the Major Supporter of U.S. Structural Ceramics Technology

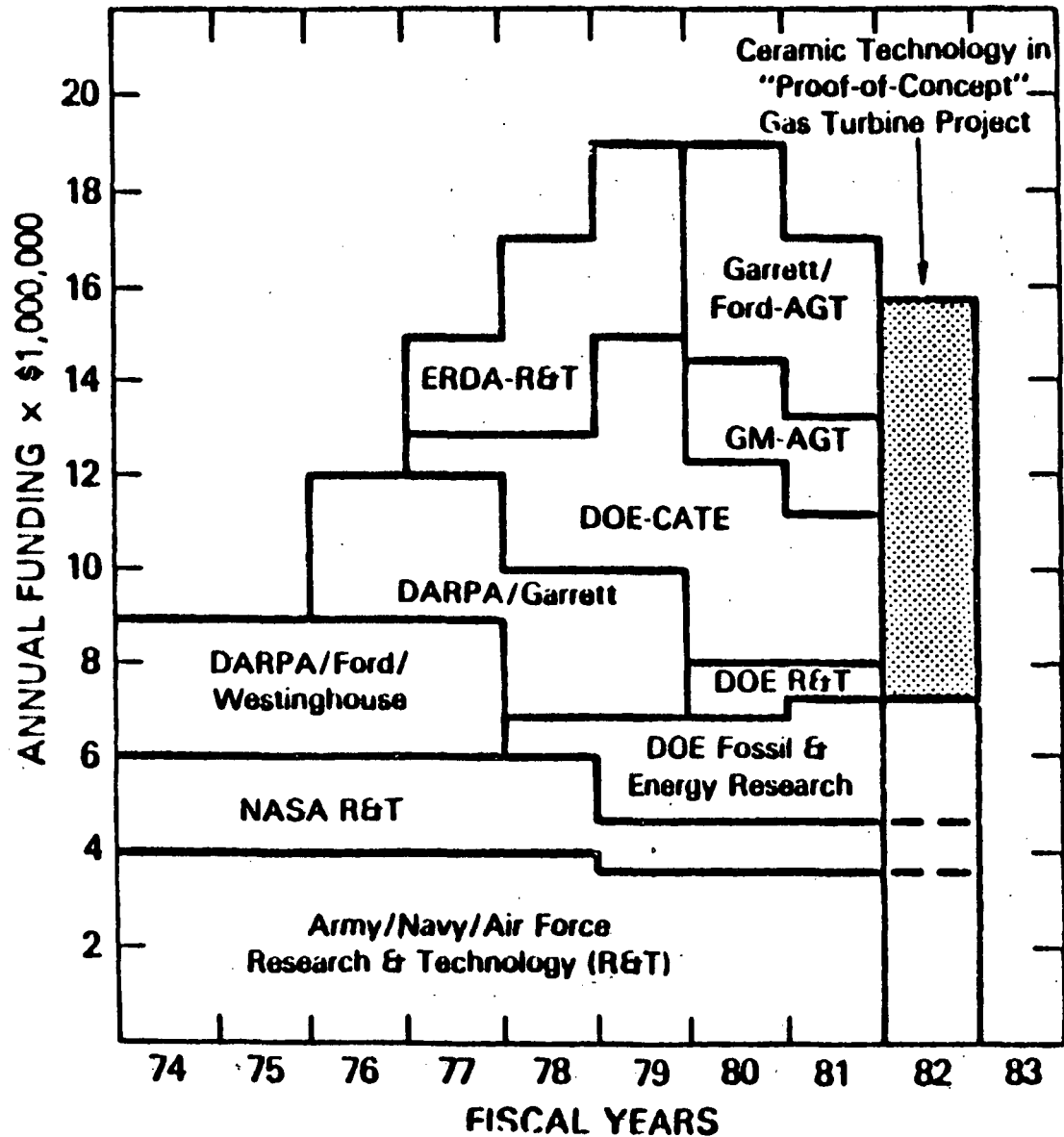

DOD CERAMIC HEAT ENGINE TECHNOLOGY

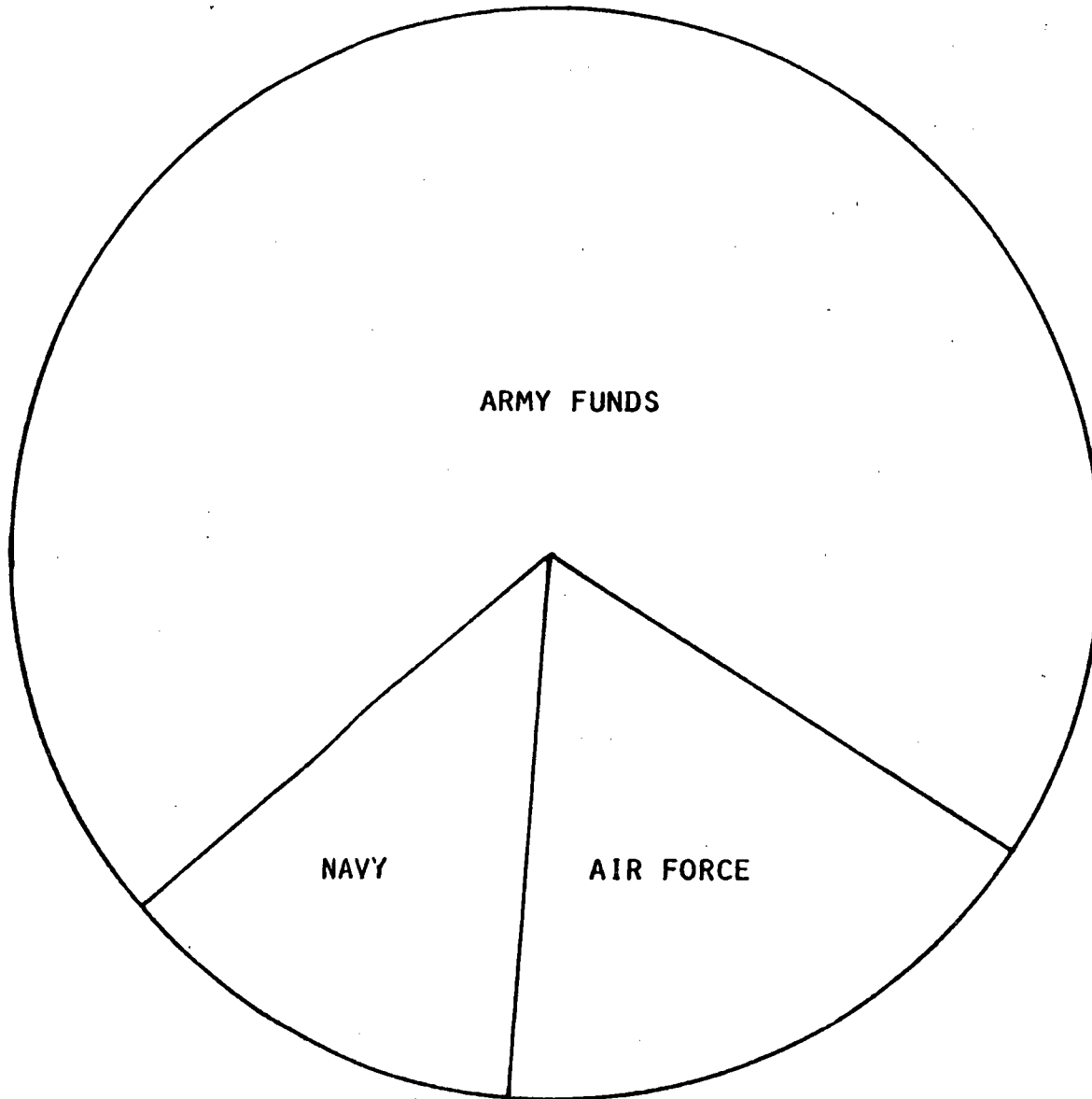

15 MILLION DURING 1979 - 1982

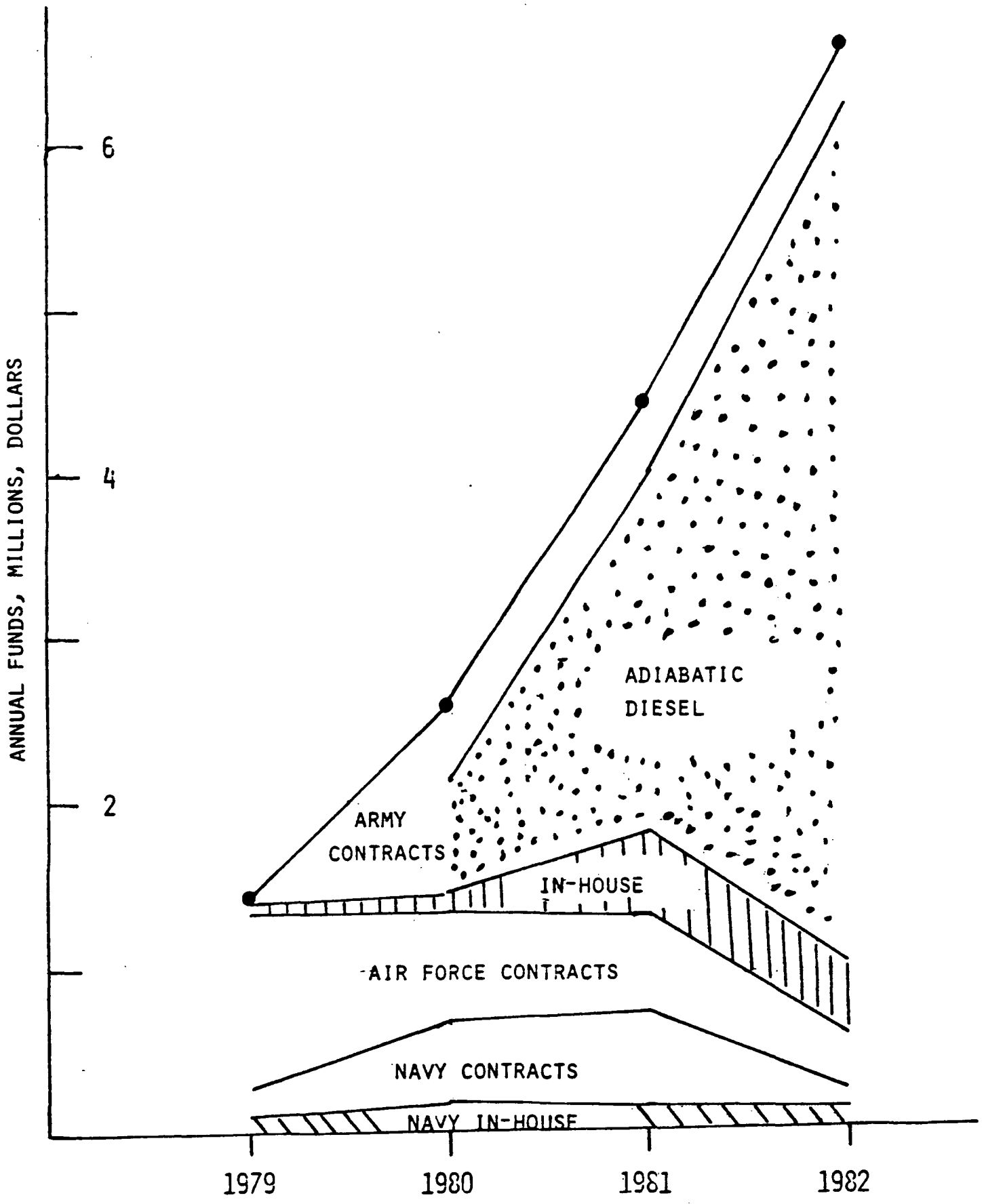

DOD CERAMIC HEAT ENGINE TECHNOLOGY

DOD CERAMIC TECHNOLOGY RESEARCH PROJECTS

Computer search was conducted September 1982 using the following keywords:

- Engine and Components, Turbochargers, Heat Exchangers
- Ceramic Materials - Si_3N_4 , SiC, Zirconia, Las, Mas

STATISTICS - FY82

Total Finds - 43

Army - 24

Navy - 13

Air Force - 6

No classified information considered

TOPIC

CUMMULATIVE FUNDS (Thousands)

● APPLICATIONS	\$8,922
● MATERIALS DEVELOPMENT	867
● BASIC RESEARCH - ARMY RESEARCH OFFICE	573
● CHARACTERIZATION	215
	<hr/>
TOTAL	\$10,577

ARMY SUMMARY 1979-1982

ARMY SUMMARY - 1979-1982

APPLICATIONS

● Advanced Turbine Engine Cycle Design/Analysis 1500-2000 HP range - Williams Research	\$ 132K
● Si ₃ N ₄ Forging Dies	40K
● Net Shape Radial Turbine Rotor - Garrett AiResearch	399K
● Ceramic Roller Bearing - Cooperative Tests	80K
● Advanced Adiabatic Technology	1,415K
● Adiabatic Diesel	6,848K
Total	\$8,922K

ARMY SUMMARY - 1979-1982

MATERIALS DEVELOPMENT

● Sinterable Si_3N_4 - Gazza, AMMRC	\$164K
● Reactive Gas Pressure Sintering - Gazza, AMMRC	120K
● Ceramics for Improved Toughness - Gazza, AMMRC	390K
● Oxynitride Glass and Ceramic Fiber Composites - Messier, AMMRC	193K
Total	\$867K

ARMY SUMMARY - 1979-1982

CHARACTERIZATION

- Fracture and Creep - Quinn, AMMRC \$215K

NONDESTRUCTIVE EVALUATION

- Ceramic Specimen Evaluation - AMMRC 25K
 - NDE for Bearings, Federal Mogul 20K
 - Photoacoustic Microscopy - TACOM 308K
- Subtotal. 353K

ARMY SUMMARY

BASIC RESEARCH

- Residual Stress Mechanisms for Multiaxial Stress in Polycrystalline Oxides - Hasselman, UPI \$164K
- Reduced Grain Boundary Mobility - RPI 31K
- International Symposium on Fracture - Penn State 5K
- Diesel Engine Gas Side Heat Flux - University of Wisconsin 88K

(Incl. Materials Development)

- Zirconia Based Ceramics - Hear, Case Western 177K
- Sinterable Ceramic Powders from Laser Heated Gas Phase Reaction - MIT 25K
- HIP of Sintered Ceramics 83K

Total \$573K

AIR FORCE SUMMARY - Past Four Years

- Characterization of Ceramics - IITRI 21 Mat'ls \$ 254K

MATERIALS DEVELOPMENT

- Metals/SiC/Glass/SiC/Si₃N₄ - Systems Research Labs. 460K
- Ductile and Tough Hi Temp Mat'ls - Systems Research Labs 1,012K
- Computer Thermodynamic Analysis of Materials Processing-
Glass Forming Systems - Cambridge ManLabs 188K

APPLICATIONS

- Manufacturing Technology for Ceramic Turbine Engine
Components - AiResearch 707K

Total \$2,621K

NAVY SUMMARY - Past Four Years

FAILURE PHENOMENA

- Contact Stress/Richerson - Tree \$ 194K
- Micro and Macro Fracture - Evans 458K
- Toughening Mechanism - Lange 96K

MATERIALS DEVELOPMENT

- SiC/Glass and Carbon Fiber/Glass - United Tech 150K

APPLICATIONS

- Si₃N₄ Bearings - SKF, Federal Mogul, In-house 344K
- Stabilized ZrO₂ Coatings - Rice 128K
- Multifunctional Incenerators 77K
- Cruise Missile Type Bearings 288K
- Ceramic "Expander Piston" 158K

Total \$1,817K

REVIEW OF NASA PROGRAMS ON STRUCTURAL CERAMICS

THOMAS J. MILLER
NATIONAL AERONAUTICS AND SPACE ADMINISTRATION

**REVIEW OF NASA
PROGRAMS
ON
STRUCTURAL
CERAMICS**

T. J. MILLER
HEAD, CERAMICS SECTION
NASA LEWIS RESEARCH CENTER
SEPTEMBER 1982

NASA/LERC CERAMIC PROGRAM

OVERVIEW

- IN-HOUSE RESEARCH
 - MONOLITHIC CERAMICS
 - CERAMIC MATRIX COMPOSITES
 - THERMAL BARRIER COATINGS
 - NON DESTRUCTIVE EVALUATION
 - FRACTURE MECHANICS
 - CARBON/CARBON COMPOSITES

- DOE/NASA PROJECT MANAGEMENT
 - CERAMIC APPLICATIONS IN TURBINE ENGINES (CATE) PROJECT
 - ADVANCED GAS TURBINE (AGT) PROJECT
 - HEAVY DUTY TRANSPORT TECHNOLOGY PROJECT
 - STIRLING ENGINE PROJECT

NASA/LERC CERAMIC PROGRAM

MONOLITHIC CERAMICS

OBJECTIVE: TECHNOLOGY FOR RELIABLE CERAMICS FOR
HEAT ENGINE APPLICATIONS

APPROACH: MATERIAL/PROCESSING STUDIES TO DETERMINE
INTERRELATIONSHIPS AMONG

- STARTING POWDER
- DENSIFICATION
- MICROSTRUCTURE
- PROPERTIES

MATERIALS: SINTERED SILICON CARBIDE
SINTERED SILICON NITRIDE
SINTERED REACTION BONDED SILICON NITRIDE

FY83 RESOURCES: 6 PROFESSIONAL MAN YEARS
\$400K ORIGINAL PLAN
\$2.0M RECENTLY REPROGRAMMED FOR NEW INITIATIVE

NASA/LERC CERAMIC PROGRAM

CERAMIC MATRIX COMPOSITES

OBJECTIVE: DEVELOP UNDERSTANDING OF PROCESSING/PROPERTIES OF CERAMIC MATRIX COMPOSITES

APPROACH:

- EXPERIMENTAL STUDIES TO UNDERSTAND PROCESSING/PROPERTY INTERRELATIONSHIPS
 - IN SITU PYROLYSIS OF POLYMERS
 - NITRIDATION OF POUROUS Si MATRIX
- ANALYTICAL STUDIES OF FRACTURE BEHAVIOR
 - DEVELOP MODELS FOR STRENGTH AND TOUGHNESS

MATERIALS: SILICON CARBIDE, REINFORCED SILICON NITRIDE
GRAPHITE AND SILICON CARBIDE REINFORCED GLASSES

RESOURCES: 3 PROFESSIONAL MAN YEARS
\$145K

CERAMIC TECHNOLOGY FOR

ADVANCED HEAT ENGINES

A JOINT DOE - NASA

NEW PROGRAM INITIATIVE

150

CERAMIC TECHNOLOGY FOR ADVANCED HEAT ENGINES

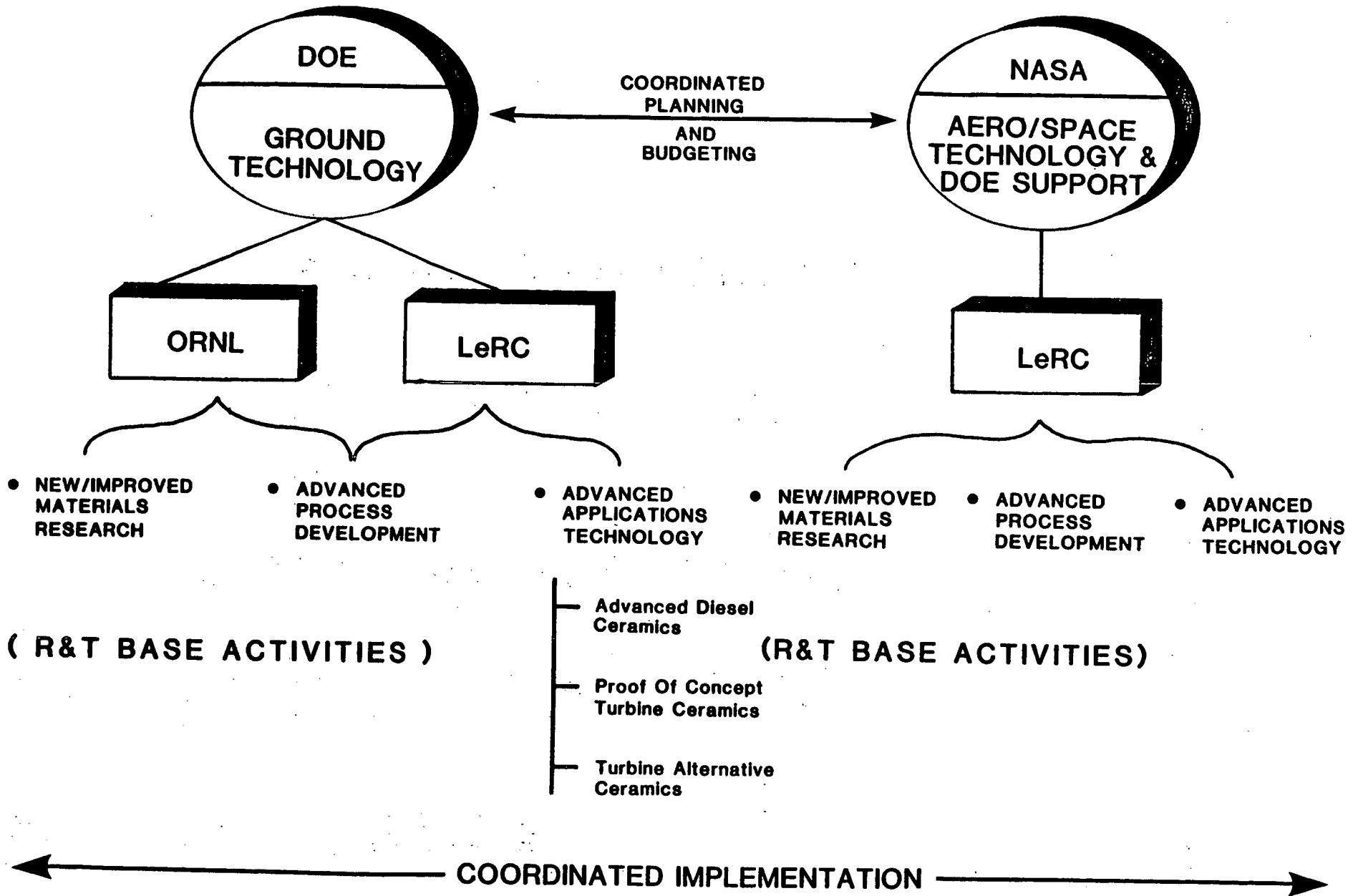

PROPOSED NEW INITIATIVE FOR CERAMICS

OBJECTIVES

- TO BRING STRUCTURAL CERAMICS TO A STATE OF TECHNOLOGY READINESS AT WHICH THEY COULD BE CONSIDERED BY ENGINE DESIGNERS AS VIABLE ENGINEERING MATERIALS FOR ADVANCED HEAT ENGINES
- TO HELP MAINTAIN A VIABLE DOMESTIC CERAMICS INDUSTRY THROUGH STRENGTHENING OF THE BASE R&T LEVEL IN STRUCTURAL CERAMICS

APPROACHES

MAKE CERAMICS MORE RELIABLE AND REPRODUCIBLE BY:

- UNDERSTANDING AND APPLYING FUNDAMENTAL RELATIONSHIPS AMONG STARTING MATERIALS/PROCESSING/MICROSTRUCTURE/PROPERTIES
- IMPROVING DESIGN AND DESIGN APPROACHES FOR CERAMIC HEAT ENGINE COMPONENTS
- IMPROVING THE LIFE PREDICTION CAPABILITIES FOR CERAMIC HEAT ENGINE COMPONENTS

A DUEL AGENCY APPROACH TO A COMMON GOAL

- APPROACHES TO CERAMICS OF IMPROVED RELIABILITY ARE APPLICABLE TO BOTH AEROSPACE AND GROUND-BASED NEEDS
- LEWIS AND ORNL HAVE AGREED TO A COMMON PROGRAM STRUCTURE
- THE COMMON PROGRAM STRUCTURE WILL SERVE AS FOCUS FOR EACH AGENCY'S PROGRAM PLAN

OVERVIEW OF GERMAN PROGRAM -
CERAMIC COMPONENTS FOR VEHICULAR GAS TURBINES
1974-1983

EDWARD M. LENOE
ARMY MATERIALS AND MECHANICS
RESEARCH CENTER

OVERVIEW OF GERMAN PROGRAM
CERAMIC COMPONENTS FOR VEHICULAR GAS-TURBINES
1974 - 1983

DR. EDWARD M. LENOE

**MITTELVERBRAUCH IN TDM IM GESAMTEN PROGRAMM
"KERAMISCHE BAUTEILE FOR FAHRZEUG-GASTURBINEN" (1974 - 83)**

	FÖRDERSUMME	GESAMTMITTEL
INDUSTRIE	43.791	87.582
UNIVERSITÄTEN UND INSTITUTE	9.351	9.351
G E S A M T	53.142	96.933

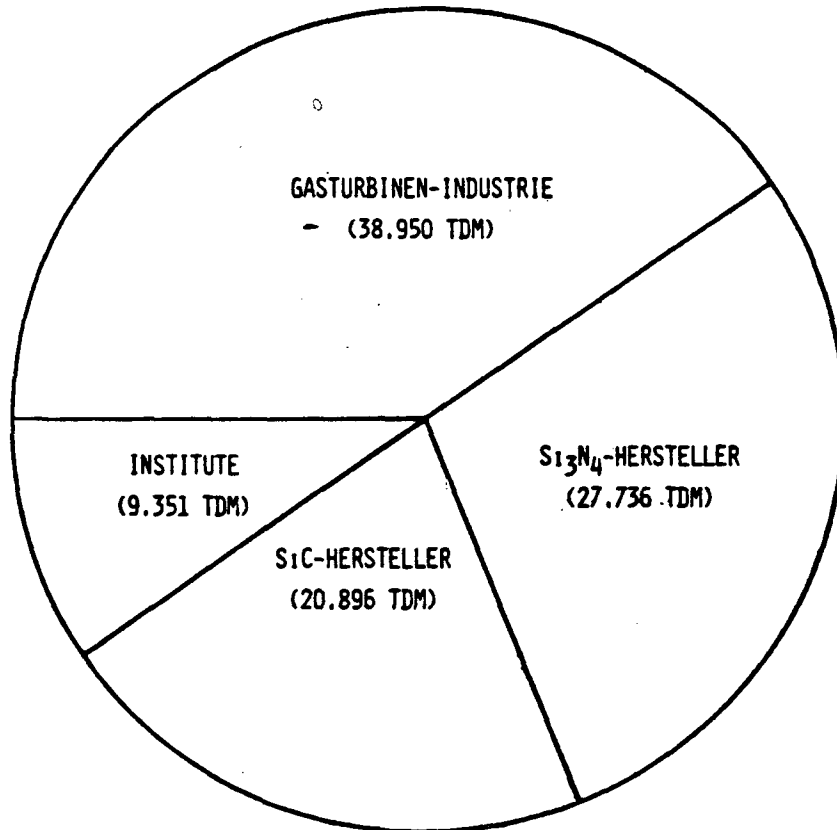

AUFTEILUNG DER INSGESAMT AUFGEWENDETEN MITTEL

BETEILIGUNG DER FIRMEN UND INSTITUTE WAHREND DER GESAMTEN LAUFZEIT

GASTURBINEN-INDUSTRIE

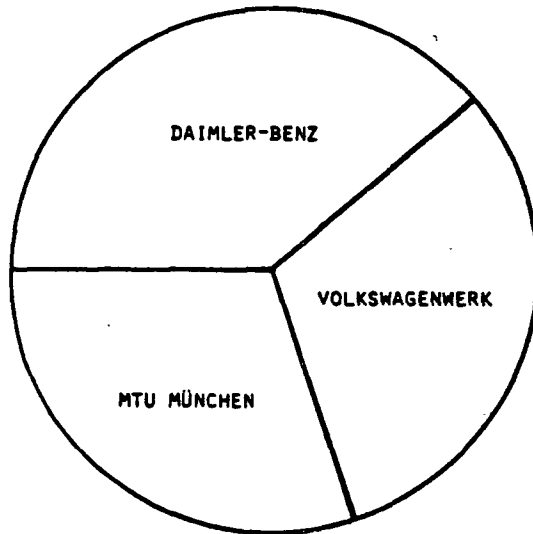

FORSCHUNGSINSTITUTE

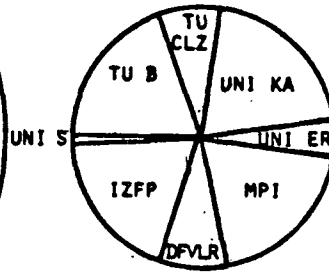

Si₃N₄-HERSTELLER

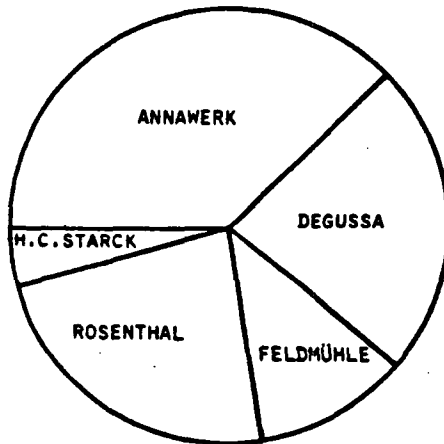

SiC-HERSTELLER

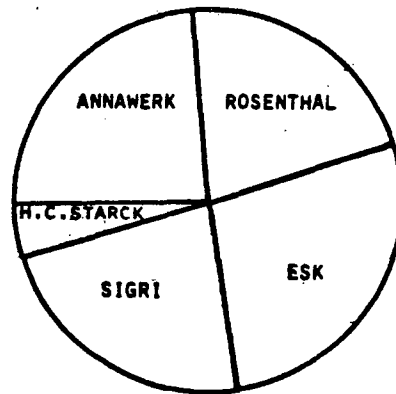

(BEZUG: GESAMTMITTEL, FLÄCHENGETREU)

DEVELOPMENT GOALS UNTIL 1983 OF THE PROGRAM
"CERAMIC COMPONENTS FOR VEHICULAR GAS-TURBINES"

1. STATIONARY COMPONENTS (Combuster, Nose-Cone, Stator, Rotor Shroud)

Production of original components from various materials and 200 H-tests in a simulated duty cycle with a max. combustor outlet temperature of 2500 F and an inlet pressure of 75 psi.

2. HEAT EXCHANGER

Production of a Si_3N_4 -recuperator with a wall thickness of 0.2mm, a pressure ratio of 5, an allowable leakage of 5% and a max. temperature of 2200 F inlet temperature, 10 H-test.

3. ROTOR

- Metal-Ceramic-Rotor (cars and trucks)
200 H-test in duty-cycle
(inlet temperature 2285 F)
- All Ceramic Rotor (car)
50 H-test in duty-cycle
(inlet temperature 2500 F)

<u>COMPANY</u>	<u>POWER</u>	<u>COMPONENTS</u>	<u>ROTOR-CONCEPT</u>
Volkswagen	100 KW	Rotor Stator (Combustor)	Hybridrotor Monolith. RBSN-rotor
Daimler-Benz	150 KW	Rotor Inlet-Scroll Recuperator	Monolith. HPSN-rotor
MTU	300 KW	Rotor Stator Combustor	Hybridrotor

ACTIVITIES OF RESEARCH INSTITUTES

<u>Institute</u>	<u>Activity</u>
Max-Planck-Institut-Stuttgart	Basic Research
TU Berlin	Powder Technology
TU Clausthal-Zellerfeld	Joining Technique
Izfp Saarbrücken	NDT
TU Karlsruhe	Creep Properties
Universität Erlangen	HT Fracture Mechanics
DFVLR Köln	Material Characterisation Project Management

ACTIVITIES OF COMPANIES

	<u>Combustor</u>	<u>Stator</u>	<u>Rotor/Blades</u> <u>Rotor Rings</u>	<u>Recuperator</u>
Material	Annawerk Rosenthal Sigri	Annawerk Rosenthal Sigri	Annawerk Degussa ESK Feldmühle	Rosenthal
Design	MTU VW	MTU VW	DB MTU VW	DB

Material		Cold Forming					Hot Forming			Trade Mark
		Axial + iso-dry press.	Slip casting	Warm molding	Injection molding	Extrusion	Powder hot press.	Post hot pressing	Hot isost.-pressing	
162 Silicon Nitride	Reaction bonded	X	X	X	X	X				Ceranol NR
	Sintered	X	X		X					Ceranol ND
	Hot pressed						X	X	X	Ceranol NH
Silicon Carbide	Reaction bonded	X	X		X	X				Ceranol CS
	Sintered	X	X		X					Ceranol CD
	Hot pressed						X			Ceranol CH

Annawerk
Ceranol

Overview
Annawerk - Ceranol Materials

Datum 5. 2. 81
Zchnng-Nr. 81001.

OVERVIEW OF JAPANESE STRUCTURAL CERAMICS RESEARCH

ROBERT J. GOTTSCHALL, DOE

OVERVIEW OF JAPANESE STRUCTURAL CERAMICS RESEARCH

Robert J. Gottschall
Division of Materials Sciences
Office of Basic Energy Sciences
ER-131, GTN
U.S. Department of Energy
Washington, DC 20545

OBJECTIVES:

In order to better understand Japanese R&D to develop viable technological high-temperature structural ceramics and the capability to reliably manufacture these materials, I visited four national laboratories, three universities, and four private companies that are involved with such efforts in September 1982.

JAPANESE MOTIVATIONS:

My analysis of select aspects of ceramics research in Japan makes it clear that the present Japanese effort to further develop superior technological ceramic materials and capture products and markets based on them is one of major proportions. This well-conceived plan involves a long-range commitment to invest resources by both the Japanese government and the private sector. In order to understand this dedicated commitment and the excellent programmatic coordination that has evolved from it one must comprehend the underlying motivations from which it has its origins.

The population of Japan, which is about half that of the United States, inhabits a land area approximately equal to that of the State of California. The Japanese archipelago is poor in natural mineral and energy resources, making many contemporary technological minerals and metals take on a critical or strategic significance to the Japanese economic posture. Japan's economic survival is dependent upon having a self-sufficiency derived from a base of technological and labor skills to process its few natural resources into viable materials, especially crystalline and glassy ceramics, and manufactured or assembled parts for export. Company planners seek to continuously develop these necessary technologies, and the government assists in the coordinated planning for R&D activities in the government laboratories, universities, and private industry that are necessary to achieve this requisite technology base. Thus, the first motivation is to attain an economic self sufficiency which in turn necessitates compensating for Japan's limited natural mineral resources by developing an appropriate base of technology involving non-imported technological materials. The second motivation is that without such technological materials which possess reliable behavior under the severe conditions of high temperature and other hazards, the construction of better competitive energy systems, and Japanese self-sufficiency in an energy-dominated world economy will not be achieved. Furthermore, it is considered crucial that this materials development be timely, as industry will not wait, and as has been the case in the U.S., would compromise on design and system performance by using traditional materials which are already

available. There has, therefore, been much emphasis on motivating researchers to engage in long-term basic research, especially on advanced materials with potentially attractive high-temperature properties and behavior, such as structural ceramics for application at 1500°C. A third motivation is that the Japanese have already achieved preeminence in the subject of electronic ceramics (which are used in or for multilayer capacitors, dielectric devices, integrated circuit substrates, ferroelectrics, varistors, sensors, etc.) where they now dominate the world's market. This existing technology-base for electronic ceramics can be broadened and transferred into other ceramic applications such as high temperature structural ceramics for a relatively small additional increment of effort. The fourth motivation is that the Japanese see not only internal self sufficiency, but large world markets to be gained by virtue of their efforts to develop viable high-temperature structural ceramics. Some of these markets are high volume-low technology, such as those for ballpoint pen tips and fish hooks which they now make with Si_3N_4 . Other high-temperature structural ceramics markets, however, are high technology ones such as automobile engines, heat exchangers, fusion first walls and limiters, and large-scale stationary turbines. Regardless, however, of whether the ultimate ceramic product to be marketed is technological in nature, the philosophy of government and company planners in Japan is to stimulate the futuristically oriented exploitation of basic research on new materials so as to ultimately develop new products and markets.

MANAGEMENT AND FUNDING OF CERAMICS RESEARCH AND DEVELOPMENT:

As is the case in the United States, R&D activities in Japan may be categorized as national laboratory, university, and private companies.

Ceramic materials have been most thoroughly studied in Japan at four of Japan's many national or government institutes: the three Government Industrial Research Institutes (GIRIs) at Nagoya, Kyushu, and Osaka, and the National Institute for Research on Inorganic Materials (NIRIM) at Tsukuba. The GIRIs are funded by the Ministry of International Trade and Industry, MITI. GIRI-MITI projects are performed in close cooperation with private companies and industrial development directly reflects data and results obtained from these projects. NIRIM which is funded under the Agency for Science and Technology also maintains excellent cooperation with private companies, but its charge is solely to perform basic research.

There are two systems which affect the conduct of research at Japanese national laboratories: the Research Group System and the Visiting Research Officer System. A research theme is proposed by a scientist, or a few scientists, who want to investigate it. Detailed plans of the project are broadly discussed with all other researchers including visiting scientists and the various internal and external committees. The Laboratory Director then makes the final decision. A completion date is set at the outset of each project. At the end of this period, which typically might be five years from the outset of the project, the research may either be regarded as completed or be extended for a specific period. When the project is finally completed, the members of the research group will be assigned to other research groups and new projects. The research group itself is composed of specialists with different professional disciplines that are necessary to

form an effective interdisciplinary effort. This mix of interacting professionals may include physicists, chemists, crystallographers, mineralogists, metallurgists, ceramists and various other disciplines that are related to materials science. Every Research Group that I visited at three GIRIs and NIRIM had present visiting scientists from private companies that have been assigned to spend from one to three years in residence as research participants. The salary and relocation expenses for these visiting scientists are paid for by their parent employer. I also observed on-leave university researchers at the GIRIs and NIRIM. The objectives of this visiting research officer system are to promote cooperative-collaborative efforts between the industry-university-national laboratory systems, exchange knowledge and expertise, to provide training for younger researchers within the research group, and to facilitate technology transfer to those companies that assign their personnel to the GIRIs or NIRIM.

NIRIM and perhaps the GIRIs would like more opportunities to collaborate with foreign countries including the U.S. However, it is probable that the Japanese laboratories would only provide for research expenses, since salaries paid by the Japanese national laboratories are allocated only for Japanese, and Japan does not have postdoctoral fellowships. I made a presentation at most of the institutions I visited on our Materials Sciences programs in structural ceramics, and have sent each a copy of our annual Program Book. The Japanese have a keen awareness of our programs and follow their publications very closely.

A tabular summary of the funding and personnel levels at the four national laboratories I visited is shown on the following page.

The sole source of government support for university research in Japan is the Ministry of Education, Science, and Culture. No overhead or salaries for faculty, staff, or students is included in the research funds allocated to universities. Thus, it is impossible to make a simple comparison with university research funding in the U.S. where salary and overhead expenses typically consume ~80% of the total funds. These funds from the Ministry of Education, Science, and Culture are separated into two categories. One category is direct grants for research awarded in response to formal proposals. The amount of such awards from the "Functional Ceramics" program range from \$2K to over \$100K, and they are spent largely for equipment and instrumentation. The Functional Ceramics program is now funding 48 professors at 12 universities for three year durations. The second category of funds is for general laboratory equipment, such as that used for non-research laboratories such as those devoted to instruction. This amount is divided equally among all the divisions in a school, but varies in each university, ranging from \$5K to \$15K per professor. One need not perform research or submit a research proposal to be a recipient of funding in this second category.

University research is neither small nor insular. Thus, the Institute of Scientific and Industrial Research (ISIR) at Osaka University has a permanent staff of 170 as well as 25 (temporary) research fellows and 82 (temporary) graduate students. Their annual budget of about \$4.9M is divided into \$2.2M for instrumentation, equipment, and supplies, and \$2.7M for personnel. There are presently seven "company men" serving on assignments of from one to three

FUNDING AND PERSONNEL LEVELS AT FOUR NATIONAL LABORATORIES IN JAPAN

<u>INSTITUTION</u>	<u>GOVERNMENT FUNDING AGENCY</u>	<u>MOST RECENT ANNUAL FUNDING IN DOLLARS</u>	<u>TOTAL STAFF</u>	<u>CERAMICS STAFF</u>
NIRIM	Science & Technology Agency	\$7M (total)	110 professionals (77 with Ph.D) 60 technicians and support staff	same as total
GIRI-Nagoya	Ministry of International Trade & Industry	\$6.656M wages & benefits \$4.277M research (primarily instrumentation & equipment) \$1.312M (other) \$12.245M (total)	155 professionals (43 with Ph.D.) 53 technicians 65 non-research categories	43 professionals
GIRI-Kyushu	Ministry of International Trade & Industry	\$3.7M (total)	70 professionals & technicians 25 non-research categories	25 professionals
GIRI-Osaka	Ministry of International Trade & Industry	\$4.2M (total)	180 professionals & technicians 60 non-research categories	43 professionals

years in residence at just one group, the Research Center for High Pressure Synthesis, at the Osaka University ISIR. Their salary is paid by their private company "parent" employers. Such arrangements whereby industrial personnel are assigned with full time salary by their private employer to return to school for durations of from one to three years are fairly common. They are considered to be very effective in facilitating technology transfer from universities to private companies.

Similarly the Research Laboratory of Engineering Materials at the Tokyo Institute of Technology and the Laboratory of Ceramic Materials and Solid State Chemistry of the Department of Chemistry at the University of Tokyo have large groups, extensive laboratory facilities, and an abundance of private company employees engaged in multi-year research in residence programs.

Three of the four companies I visited showed me their extensive well-equipped laboratories, which contained forefront analytical instrumentation and specimen fabrication and processing facilities. All of this instrumentation and equipment is purchased with company funds. MITI does provide funding for basic research to be carried out in private industry, but it appears to be a token symbol. From my discussions with corporate executives and research directors, I would suggest that the ratio of corporate to MITI funds for basic ceramic research in industry might be around 25:1 for those programs where there are MITI funds. There are, however, basic ceramic research programs underway in private industry where there are no government funds at all.

The four companies I visited invest their own funds in basic ceramic science, and are willing to provide continuous support for it for durations of ten to fifteen years without having a commercial product.

COMPARATIVE LEVEL OF EFFORT:

Because there are several private foundations (Electric Power Development Co., Ltd., Japan Coal Development Co., Ltd., New Energy Foundation, etc.) starting to make large contributions towards the funding of Japanese research on high temperature structural ceramics, and because there is a significant amount of in-house non-government funded research in the private industrial sector on this subject, I cannot estimate the total Japanese level of effort. It should also be recalled that Japanese government funding of university research does not go towards overhead or the salaries of faculty, postdoctorals, or students. Thus, it is not possible to make a direct comparison between the U.S. and Japanese levels of effort in terms of cost outlays.

GOVERNMENT PROGRAMS:

MITI sponsors several programs. The MITI "Project Moonlight" has the objective of fostering energy conservation and had a total 1981 budget of about \$37M. It was initiated in 1978, is to last for seven years, and has five subprojects. Four of these subprojects are waste heat utilization, magnetohydrodynamics, advanced battery energy storage, and fuel cells, and the success or failure of all of these programs will be critically dependent

on the behavior of their respective ceramic component materials. The remaining subproject is the Advanced Gas Turbine (AGT) which has a total seven year budget of about \$95M. The AGT program objective is to improve gas turbine generating efficiency from 40% to at least 55% by means of a combined power plant that combines gas turbines and steam turbines, and will have an inlet gas temperature of 1500°C. The first trial test is scheduled for 1983 on a prototype 10⁵kw class system. The MITI-AGT program will provide \$9.1M in funds for structural ceramics research for this seven year duration, and provide \$1.4M for this purpose in 1982. The Moonlight Project also has the charge to promote international cooperation in research and development concerning energy conservation.

The MITI "Project Sunshine" has the objective of developing new energy sources and systems that do not rely on petroleum, and has emphasized geothermal and solar energies and more recently coal liquefaction. The 1981 Sunshine plan also identified coal gasification, hydrogen production, and international cooperation activities. The latter is aimed at cooperation on research and development with the U.S., Australia, and the International Energy Agency participant countries. I was not able to obtain Sunshine funding levels for materials sciences disciplines, probably because they are contained within the various Sunshine energy programs.

MITI has also organized the Industrial Base Technology Development Project, which was initiated in 1981 and will continue through 1990, and has a ten year total budget of \$450M. It contains a subprogram that is known by the two names "high-performance ceramics" and "fine ceramics" which had an initial year's budget of \$1.65M, but will achieve a ten year total funding level of \$56M. These numbers are deceptive, however, because the participating industrial companies generally provide with their own funds a level of effort that might be 25 times the MITI funding level. The main participants in this MITI Fine Ceramics program consist of four national laboratories and fourteen private companies. The stated objectives of this program are (1) achievement of reliability in ceramic materials, (2) establishment of a high temperature engine system which utilizes brittle materials, and (3) basic research in the area of ceramic materials.

The Science and Technology Agency initiated a five year program of creative scientific and technological research in materials science in 1981. The topics selected for study are (1) ultrafine powders, (2) special structural materials, (3) fine polymers, and (4) perfect crystals. Each topic involves 20 scientists and is funded at a level of about \$2M per year. Patents will be shared by the researchers and the agency.

SIGNIFICANT RESEARCH THRUSTS OR ACCOMPLISHMENTS:

The synthesis of size-monodispersions (i.e. narrow range of sizes) of sub-micron high-purity non-oxide powder of known and controlled purity is both advanced as well as the subject of a high priority effort. Synthesis methods include chemical vapor deposition and hydrothermal reactions. Critical parameters for such powder are particle size distribution, shape, surface chemistry, surface structure, and surface activity. Critical behaviors include agglomeration, flocculation, aging, environmental reactivity, ordering, and packing.

Various consolidation methods are being investigated for achieving densification of ceramic powders with a homogeneous microstructure that is free of deleterious grain boundary phases. These methods include sintering, reactive sintering, gas-pressure sintering, hot isostatic pressing, dynamic (explosive) compaction, and hydrothermal methods. The use of very high pressures (GPa range) to achieve both densification and materials synthesis is being actively investigated, and it is believed that high-pressure technology can be used to manufacture production quantities of components with engineering dimensions. There is presently no effort to apply high-pressure technology to densify or synthesize ceramics underway under DOE support, partly because of the popular belief by U.S. industry that high pressure technology will never be used to produce production quantities.

Mechanical behavior studies on structural ceramics routinely include two types of tests almost never performed in the U.S. Tensile testing is performed because a structural component will generally be subject to an applied tensile stress that is larger than the applied compressive stress, whereas tensile strengths are much less than compressive strengths for these materials. Dynamic or cyclic stress fatigue studies are underway because the Japanese have found that structural ceramics exhibit a cyclic fatigue endurance limit, similar to fatigue in metals. Components in rotating or reciprocal engines will most likely have a service lifetime that is limited by their fatigue endurance limit under dynamic cyclic stresses. Thus, structural ceramics exhibit an applied stress-history memory effect, and can as is the case with metals, undergo cyclic fatigue failure at stresses substantially below the tensile yield stress. The purpose of this fatigue research is not only to provide necessary lifetime data, but to establish a correlation between fatigue behavior with microstructural variables so as to optimize the endurance limit.

HVEM real-time (in-situ) hot stage studies are underway at temperatures to 2100°C and gas pressures to 3MPa. The 3.0MeV HVEM at the University of Osaka also has a two stage tilt goniometer with computer controlled eucentric correction features (which is necessary for real-time movies). This unique capability is used for the direct observation of phenomena such as sintering, pressure sintering, pore annihilation, grain boundary migration, particle coarsening, dislocation reactions (in conjunction with a deformation stage), and solid surface-environmental atmosphere reactions. It is a most powerful tool when integrated as it is with various investigations of reactions in ceramics at high temperatures.

Various heat engine components that are being fabricated from structural ceramics include scrolls, nozzles, combustors, shrouds, hot-plugs, locker arms, tappets, ball bearing balls, stators, blades, piston caps, cylinder heads, cylinder liner inserts, pipes, valves, and heat exchanger tubes. Not all of the applications for structural ceramics are high-technology, however, as is evidenced by the commercialization of Si₃N₄ ball point pens and fish hooks, and ZrO₂ cutlery and scissors for cutting magnetic tape. The Japanese hope to cultivate mass-manufacturing methods with these structural ceramics initially with low-technology products because they believe this experience will help them develop the technology base and manufacturing quality assurance required for the ultimate commercialization

of high-temperature structural ceramic components and products. In terms of ceramic heat engines the time-sequence of their priorities for commercialization is first ceramic engines with turbocharger rotors, next adiabatic diesel engines, and ultimately completely ceramic gas turbines.

The preparation of well characterized sub-micron powder of controlled and known purity is also recognized as a marketable product, and is now being scaled-up for mass production quantities. Particularly innovative research is now underway concerning the fabrication and behavior of all-ceramic and ceramic matrix composite materials and sol-gel processed hollow glass microspheres for laser-induced fusion energy. Other important research subjects on structural ceramics include corrosion, oxidation, ultrasonic flaw detection, acoustic emission, fracture toughness, creep, cyclic fatigue, thermal shock, and various synergisms such as thermal fatigue, stress corrosion, etc.

DOE COLLABORATIVE RESEARCH CENTERS

DON M. PARKIN (DOE)

Basic materials research which is long range, generic in nature, is conducted by the Office of Basic Energy Sciences/Division of Materials Sciences to provide an underpinning for the development of energy systems. In the pursuit of these research goals, facilities or centers which are unique and/or expensive and costly to reproduce elsewhere have been and are being developed. Scientists from other laboratories outside of the host laboratory are encouraged to make use of these unique facilities. In this section, a description is included for a number of the most important centers together with a statement of the method of gaining access to them. The collaboration carried out by outside users has to be in the furtherance of DOE objectives. Any activity which can be carried out through commercially available laboratories is not appropriate for these DOE centers. In addition, proprietary research cannot be conducted unless there is full cost recovery. Each center has a slightly different mode of operation tailored to its best use. For more information, it is recommended that the reader make use of the laboratory contacts listed.

NATIONAL SYNCHROTRON LIGHT SOURCE

Brookhaven National Laboratory
Upton, New York 11973

The National Synchrotron Light Source (NSLS) facility consists of a 700 MeV (9 electron bunch) storage ring for VUV and IR research and a 2.5 GeV (30 electron bunch) storage ring for X-ray research. Attractive features of the synchrotron radiation include high brightness and intensity, its broad and continuous spectral range, high polarization and pulsed time structure (sub-nanosecond pulses). With each of the 28 X-ray and 16 VUV beam ports being further split into from 2 to 4 beam lines, it will be possible to have as many as 100 experiments running simultaneously at the NSLS.

The NSLS is a facility where a wide range of research techniques will be utilized by biologists, chemists, solid state physicists, metallurgists, and engineers for basic and applied studies. Among the techniques are EXAFS (extended X-ray absorption fine structure), scattering, diffraction, topography, fluorescence, interferometry, gas phase spectroscopy, photoemission, lithography, microscopy, dichroism, and infrared vibrational spectroscopy.

USER MODE

The policy for experimental utilization of the NSLS is designed to enable the scientific community to cooperate in the design and fabrication of experimental apparatus. In addition to the beam lines constructed by the NSLS staff for general usage, a large number of beam lines are being designed and instrumented by "Participating Research Teams" (PRTs). The PRTs are given priority for up to 75% of their beam line(s) operational time for a three-year term.

General Users will be able to perform experiments on an NSLS facility beam line or on a PRT beam line which will be available for use by non-PRT members for at least 25% of its total operational time. In the latter case, PRTs will provide liaison and utilization support to General Users. After an initial commissioning period, NSLS and PRT beam lines will become available for use by General Users.

Proprietary research can be performed at the NSLS. A full-cost recovery fee will be charged for the amount of beam time utilized. The DOE has granted the NSLS a Class Waiver, under the terms of which Proprietary Users of the NSLS will have the option to retain title to inventions that result from research performed at the Light Source.

A limited amount of funding will be available to scientists from U.S. institutions of higher education under the NSLS-HFBR Faculty/Student Support Program. The program is designed to defray expenses incurred by faculty/student research groups performing experiments at the NSLS or at the HFBR. It is aimed at university users having only limited grant support for their research, and will be used to support only the most deserving cases.

PERSON TO CONTACT FOR INFORMATION

R. Klaffky
NSLS - Bldg. 725B
Brookhaven National Laboratory
Upton, New York 11973

(516) 282-4974
FTS 666-4974

NATIONAL SYNCHROTRON LIGHT SOURCE

TECHNICAL DATA

Facilities

VUV electron storage ring

X-ray electron storage ring

Key Features

high brightness, continuous wavelength range ($\lambda > 12 \text{ \AA}$)
16 beam lines

high brightness, continuous wavelength range ($\lambda > .5 \text{ \AA}$)
28 beam lines

Operating Characteristics

0.7 GeV electron energy

2.5 GeV electron energy

Instruments

Monochromators:

plane grating

$12 \text{ \AA} < \lambda < 1500 \text{ \AA}$
high resolution

toroidal grating

$10 \text{ \AA} < \lambda < 80 \text{ \AA}$
high intensity, moderate resolution

Wadsworth

$300 \text{ \AA} < \lambda < 3000 \text{ \AA}$
high intensity, moderate resolution

Seya & Czerny Turner

$1200 \text{ \AA} < \lambda < 12000 \text{ \AA}$
high intensity, moderate resolution

two crystal

$.04 \text{ \AA} < \lambda < 10 \text{ \AA}$
high resolution, fixed exit beam

two crystal/two grating

$2.5 \text{ \AA} < \lambda < 2500 \text{ \AA}$
high resolution, fixed exit beam

Six circle spectrometer/diffractometers

high positional and rotational accuracy

Experimental stations

photoemission, magnetic circular dichroism, fluorescence, gas phase spectroscopy, microscopy, EXAFS, scattering, crystallography, topography

Superconducting wiggler

$\lambda > .1 \text{ \AA}$
high intensity

HIGH FLUX BEAM REACTOR

Brookhaven National Laboratory
Upton, New York 11973

The Brookhaven High Flux Beam Reactor (HFBR) operates at a power of 40 megawatts and provides an intense source of thermal neutrons (total thermal flux = 0.7×10^{15} neutrons/cm²-sec). The reactor is being upgraded to operate at 60 megawatts, which will result in a 50% increase of the thermal flux to 10^{15} neutrons/cm²-sec, comparable to the highest flux beam reactors in the world. The HFBR was designed to provide particularly pure beams of thermal neutrons, uncontaminated by fast neutrons and by gamma rays. A cold source (liquid hydrogen moderator) provides enhanced flux at long wavelengths ($\lambda > 4 \text{ \AA}$). A polarized beam spectrometer, triple-axis spectrometers and small-angle scattering facilities are among the available instruments. Special equipment for experiments at high and low temperatures, high magnetic fields, and high pressure are also available. The emphasis of the research efforts at the HFBR has been on the study of fundamental problems in the fields of solid state and nuclear physics and in structural chemistry and biology.

USER MODE

The HFBR serves the U.S. scientific community and there exists a strong collaboration between the Brookhaven staff and users from universities, industry, and other national laboratories. In 1981 more than 150 persons visited Brookhaven to participate in experiments and more than 50 others collaborated from their home institutes. Experiments are scheduled at the HFBR following review of research proposals. Please contact R. Klaffky for more information and for a copy of the HFBR Handbook, which contains considerable detail on the available equipment and on operating procedures.

A limited amount of funding will be available to scientists from U.S. institutions of higher education under the NSLS-HFBR Faculty/Student Support Program. The program is designed to defray expenses incurred by faculty/student research groups performing experiments at the National Synchrotron Light Source or at the HFBR. It is aimed at university users having only limited grant support for their research, and will be used to support only the most deserving cases.

PERSON TO CONTACT FOR INFORMATION

R. Klaffky
NSLS - Bldg. 725B
Brookhaven National Laboratory
Upton, New York 11973

(516) 282-4974
FTS 666-4974

HIGH FLUX BEAM REACTOR

TECHNICAL DATA

<u>Instruments</u>	<u>Purpose and Description</u>
<u>Solid State Physics</u>	
4 triple-axis spectrometers	Inelastic scattering; diffuse scattering ; powder diffractometer; polarized beam Energy range: $2.5 \text{ meV} < E_0 < 200 \text{ meV}$ Q range: $0.03 < Q < 10 \text{ \AA}^{-1}$
<u>Biology</u>	
Small Angle Neutron Scattering	Studies of large molecules. On cold source with $20 \times 20 \text{ cm}^2$ Position sensitive area detector. Sample detector distance $L < 2 \text{ meter}$ Incident wavelength $4 \text{ \AA} < \lambda_0 < 10 \text{ \AA}$
Diffractometer	Protein crystallography $20 \times 20 \text{ cm}^2$ area detector $\lambda_0 = 1.57 \text{ \AA}$
<u>Chemistry</u>	
2 diffractometers	Single crystal elastic scattering 4-circle goniometer. $1.69 \text{ \AA} < \lambda_0 < 0.65 \text{ \AA}$
1 triple-axis spectrometer	Inelastic scattering Diffuse scattering Powder diffractometry
<u>Nuclear Physics</u>	
3 spectrometers	Neutron capture studies Energy range: $0.025 \text{ eV} < E_0 < 25 \text{ keV}$
<u>TRISTAN II (Isotope separator)</u>	Spectroscopic study of neutron-rich unstable isotopes produced from U-235 fission.
<u>Irradiation Facilities:</u>	
7 vertical thimbles	Neutron activation; production of isotopes: thermal flux: 6×10^{14} neutrons/cm ² -sec; Fast ($> 1 \text{ MeV}$) flux: 2×10^{14} neutrons/cm ² -sec.

NEUTRON SCATTERING AT THE HIGH FLUX ISOTOPE REACTOR

Solid State and Chemistry Divisions
Oak Ridge National Laboratory
Oak Ridge, Tennessee 37830

The neutron scattering facilities at the High Flux Isotope Reactor (HFIR) are used for long-range basic research on the structure and dynamics of condensed matter. Active programs exist on the magnetic properties of matter, lattice dynamics, defect-phonon interactions, fluxoid lattices in superconductors, liquid structures, and crystal structures. The HFIR is a 100 MW, light-water moderated reactor with an unsurpassed record of operating time (better than 90%). The central flux is 5×10^{15} neutrons/cm² sec and the flux at the inner end of the beam tubes is slightly greater than 10^{15} neutrons/cm² sec. A wide variety of neutron scattering instruments have been constructed with the support of the Division of Materials Sciences. Three of these are unique within this country: the triple-axis polarized-beam spectrometer, the double-crystal small-angle diffractometer, and the correlation chopper.

USER MODE

These facilities are open for use by outside scientists on problems of high scientific merit. Written proposals are reviewed for scientific feasibility by an internal review committee. It is expected that all accepted experiments will be scheduled within six months of the receipt of the proposal. No charges for the use of the beams will be assessed for research to be published in the open literature. The cost of extensive use of ORNL shop or computer facilities must be borne by the user. Travel and living expenses are also the user's responsibility. Inexperienced users will normally collaborate with an ORNL staff member. Proprietary experiments can be carried out after a contract has been arranged based on full cost recovery including a charge for beam time. A brochure describing the facilities and a booklet giving user procedures are available on request.

PERSON TO CONTACT FOR INFORMATION

H. A. Mook
Solid State Division
Oak Ridge National Laboratory
Post Office Box X
Oak Ridge, Tennessee 37830

(615) 574-5242
FTS 624-5242

NEUTRON SCATTERING AT THE HIGH FLUX ISOTOPE REACTOR

TECHNICAL DATA

<u>Beam No.</u>	<u>Instrument</u>	<u>Operating Characteristics</u>
HB-1	Triple-axis polarized-beam	Beam size - 2.5 by 3 cm max. Flux - 2.6×10^6 neut/cm ² sec at sample (polarized) Vertical magnetic fields to 5 T Horizontal fields to 2 T Variable E_0
HB-1A	Triple-axis, fixed E_0	$E_0 = 14.7$ meV, 2.353 Å Beam size - 5 by 3.7 cm max. Flux - 9×10^6 neut/cm ² sec at sample with 40' collimation
HB-2A	Liquid diffractometer with linear position sensitive detector	Beam size - 1 by 3.4 cm max. $\lambda = 0.89$ Å Flux - 6.8×10^5 neut/cm ² sec at sample with 20' collimation
HB-2, HB-3	Triple-axis, variable E_0	Beam size - 5 by 3.7 cm max. Flux - 10^7 neut/cm ² sec at sample with 40' collimation
HB-3A	Double-crystal small-angle diffractometer	Beam size - 4 x 2 cm max. Flux - 10^4 neut/cm ² sec $\lambda = 2.6$ Å Resolution - 4×10^{-5} Å ⁻¹
HB-4A	Four-circle diffractometer	Beam size - 5 x 5 mm Flux - 2×10^6 neut/cm ² sec with 9' collimation $\lambda = 1.015$ Å
HB-4	Correlation chopper	Beam size - 5 x 3.7 cm Flight path - 1.5 m 70 detectors covering 130° Variable E_0 Variable pulse width

INTENSE PULSED NEUTRON SOURCE (IPNS-I)

Argonne National Laboratory
Argonne, Illinois 60439

IPNS-I is an intermediate level pulsed spallation source dedicated to research on condensed matter. The peak thermal flux is about 3×10^{14} n/cm² sec. The source has some unique characteristics that promise to open up new scientific opportunities:

- o high fluxes of epithermal neutrons (0.1-10 eV)
- o pulsed nature, suitable for real-time studies and measurements under extreme environments
- o very low gamma-ray backgrounds

Three principal types of scientific activity are underway at IPNS-I: neutron diffraction, concerned with the structural arrangement of atoms (and sometimes magnetic moments) in a material and the relation of this arrangement to its physical and chemical properties; inelastic neutron scattering, concerned with processes where the neutron exchanges energy and momentum with the system under study and thus probes the dynamics of the system at a microscopic level; and neutron radiation effects, concerned with the defect cascades produced in a material by a fast neutron radiation field and the effect of these cascades on its physical properties. At the same time, it is expected that the facilities will be used for fundamental physics measurements as well as for technological applications such as resonance neutron radiography.

USER MODE

IPNS is available without charge to qualified scientists doing fundamental research. Selection of experiments is made on the basis of scientific merit by a Program Committee consisting of eminent scientists, mostly from outside Argonne. Scientific proposals (2 pages long) are submitted twice a year and judged by the Program Committee. Full details, including a User's Handbook, Proposal and Experimental Report Forms, can be obtained from the Scientific Secretary, Dr. T. G. Worlton, IPNS-372, Argonne National Laboratory, (312) 972-6800.

PERSONS TO CONTACT FOR INFORMATION

G. H. Lander, Projects Director	(312) 972-5518 FTS 972-5518
B. S. Brown, Operations Manager	(312) 972-4999 FTS 972-4999
T. G. Worlton, Scientific Secretary	(312) 972-6800 FTS 972-6800

Argonne National Laboratory
9700 South Cass Avenue
Argonne, Illinois 60439

INTENSE PULSED NEUTRON SOURCE (IPNS-I)

TECHNICAL DATA

NEUTRON SCATTERING Facility (Instrument Scientist)	Assignment	Range		Resolution	
		†Wave-vector	Energy	Wave-vector	Energy
Special Environment Powder Diffractometer (J. D. Jorgensen)	F5	0.5-40 Å ⁻¹	*	0.35%	*
General Purpose Powder Diffractometer (J. Faber, Jr.)	F2	0.5-100Å ⁻¹	*	0.25%	*
Single Crystal Diffractometer (A. J. Schultz)	H1	2-20 Å ⁻¹	*	2%	*
Low-resolution Medium Energy Chopper Spectrometer (J. M. Carpenter)	F4	0.1-30 Å ⁻¹	0-0.6 eV	0.02 K ₀	0.05 E ₀
High-Resolution Medium Energy Chopper Spectrometer (D. L. Price)	H3	0.3-9 Å ⁻¹	0-0.4 eV	0.01 K ₀	0.02 E ₀
Small Angle Scattering Diffractometer (E. Epperson (a), C. Borso (b))	C1	0.001- 0.3 Å ⁻¹	*	0.004 Å ⁻¹	*
Crystal Analyzer Spectrometer (T. O. Brun)	F1	3-16 Å ⁻¹	0.02- 0.5 eV	3%	2%

* No energy analysis

† Wave-vector, $K = 4\pi \sin \theta / \lambda$

(a) Materials Science -- 3 Meter Flight Path

(b) Biology -- 8 Meter Flight Path

NEUTRON BEAMS AVAILABLE FOR SPECIAL EXPERIMENTS

<u>Beam Tube</u>	<u>Current Use</u>	<u>Flight Path Length (m)</u>
F3	Vacant	6-70
C2	Polarized Neutron Exp.	6-40
C3	Solid He ³ Project	7.5-25
F6	Irradiations	6-20
H2	Irradiations	6-20
V1	Ultra-Cold Neutron Exp.	2.7-6.7

RADIATION EFFECTS

Facility
(Instrument Scientist)

Description

Radiation Effects Facility
(T. H. Blewitt)

Two vertical (5 cm ID) tubes with flux 1×10^{12} n/cm² sec and one horizontal (3.8 cm ID) tube with flux 3×10^{11} for energy greater than 0.1 MeV at 8μA; capabilities for maintaining two samples at liquid helium temperature (40K) and above

WNR/PSR SPALLATION NEUTRON SOURCE

Los Alamos National Laboratory
Los Alamos, New Mexico 87545

The WNR/PSR (Weapons Neutron Research/Proton Storage Ring) facility is a pulsed spallation neutron source driven by the 800-MeV Los Alamos Meson Physics (LAMPF) linear accelerator. Materials science research by neutron scattering is currently carried out at the WNR using the advantages of time-of-flight methods. Available instruments include: a) a general purpose diffractometer for powder, liquid, and amorphous materials structural studies; b) a single crystal diffractometer based on the Laue-TOF technique; and c) a filter difference spectrometer for chemical and optic mode spectroscopy. A considerable effort is directed toward pulsed source instrument development including a constant Q spectrometer, a chopper spectrometer, and a resonance detector spectrometer. A proton storage ring (PSR) is under construction and by 1985 the WNR/PSR will provide at 12 neutron bursts per second the world's highest peak thermal flux for neutron scattering research. In addition, it will also be a source of epithermal neutrons many orders of magnitude larger than research reactors. The WNR/PSR is being developed as a national facility with the selection of experiments based on scientific excellence and pertinence to DOE program goals.

USER MODE

User interactions are by collaborations with staff scientists or by research proposal to the neutron scattering group leader, R. N. Silver.

PERSON TO CONTACT FOR INFORMATION

R. N. Silver
MS-H805, Group P-8
Los Alamos National Laboratory
Los Alamos, New Mexico 87545

(505) 667-6069
FTS 843-6069

WNR - WNR/PSR

TECHNICAL DATA

	<u>1982</u>	<u>1985</u>
Proton Source	LAMPF	LAMPF + PSR
Proton Source Current	750 μ A	1000 μ A
Proton Source Energy	800MeV	800MeV
WNR Proton Current	5 μ A	100 μ A
Proton Pulse Width	6 μ s	0.27 μ s
Repetition Rate	120Hz	12Hz
Epithermal Neutron Current (n/eV.Sr.S)	1.6x10 ¹¹ /E	3.2x10 ¹² /E
Peak Thermal Flux (n/cm ² .S)	5x10 ¹³	1x10 ¹⁶

Instruments

Purpose and Description

General Purpose Diffractometer

Liquids and amorphous metals,
powder diffraction
wave vector 0.3-50 \AA^{-1}
resolution 0.45% powder
2% liquids

Single Crystal Diffractometer

Laue time-of-flight
spectrometer
wave vector 1-15 \AA^{-1}
resolution 2% typical

Filter Difference Spectrometer

Inelastic neutron scattering,
vibrational spectroscopy
energy trans. 35-600 meV
resolution 5-7%

NATIONAL CENTER FOR SMALL-ANGLE SCATTERING RESEARCH

Solid State Division
Oak Ridge National Laboratory
Oak Ridge, Tennessee 37830

The National Center for Small-Angle Scattering Research is supported by the National Science Foundation and the Department of Energy under an interagency agreement. The two main instruments available to users are the NSF-constructed 30-m small-angle neutron scattering facility (SANS) and the DOE-constructed 10-m small-angle x-ray scattering camera (SAXS). These instruments are intended to provide state-of-the-art capability for investigating structures of condensed matter on a global scale, e.g., from a few tens to several hundreds of angstroms. They are intended to serve the needs of scientists in the areas of biology, polymer science, chemistry, metallurgy and materials science, and solid state physics.

USER MODE

Beam time on these instruments is assigned, in general, on the basis of proposals submitted in advance. These are then reviewed by a panel of experts external to the laboratory and are rated on the basis of scientific merit. When a favorable review has been received, a staff member of the NCSASR and the user agree, usually by telephone, on a time and duration for the experiment. Ordinary charges are borne by the Center, but extensive use of support facilities (shop, computing, etc.) must be paid by the user. Users may work in collaboration with one or more staff members if they wish but such collaboration is not required. Proprietary experiments can be carried out after contractual agreement has been reached.

PERSONS TO CONTACT FOR INFORMATION

W. C. Koehler, Director NCSASR	(615)574-5232	FTS: 624-5232
G. D. Wignall, SANS-NCSASR	(615)574-5237	FTS: 624-5237
J. S. Lin, SAXS-NCSASR	(615)574-4534	FTS: 624-4534
M. Gillespie, Secretary, NCSASR	(615)574-5231	FTS: 624-5231

Oak Ridge National Laboratory
Oak Ridge, Tennessee 37830

NATIONAL CENTER FOR SMALL-ANGLE SCATTERING RESEARCH

TECHNICAL DATA

30-m SANS Instrument Specifications

Monochromator: six pairs of pyrolytic graphite crystals
Incident wavelength: 4.75 Å or 2.38 Å
Wavelength resolution: $\Delta\lambda/\lambda = 6\%$
Source-to-sample distance: 10 m
Beam size at specimen: 0.5-3.0 cm diam
Sample-to-detector distance: 1.5-18.5 m
K range: $5 \times 10^{-3} \leq K \leq 0.6 \text{ \AA}^{-1}$
Detector: 64 by 64 cm²
Flux at specimen: $10^4 - 10^6$ neutrons cm² s⁻¹ depending
on slit sizes and wavelength

10-m SAXS Instrument Specifications

Monochromator: hot-pressed pyrolytic graphite
Incident wavelengths: 1.542 Å (CuK_α) or 0.707 Å (MoK_α)
Source-sample distances: 0.5, 1.0, 1.5, . . . , 5.0 m
Beam size at specimen: 0.1 by 0.1 cm (fixed)
Sample-detector distances: 1, 1.5, 2.0, . . . , 5 m
K range covered: $3 \times 10^{-3} \leq K \leq 0.3 \text{ \AA}^{-1}$ (CuK_α)
 $6 \times 10^{-3} \leq K \leq 0.6 \text{ \AA}^{-1}$ (MoK_α)
Maximum flux at specimen: 10^6 photons per second on sample-irradiated
area 0.1 by 0.1 cm
Detector: 20- by 20-cm² (electronic resolution 0.1 by 0.1 cm²)
Special features: deformation device for dynamic scattering experiments
(time-slicing in periods as short as 100 μs for oscillatory experi-
ments or 10 s for transient relaxation experiments) and interactive
graphics for data analysis

NATIONAL CENTER FOR ELECTRON MICROSCOPY

Lawrence Berkeley Laboratory
University of California
Berkeley, California 94720

The National Center for Electron Microscopy (NCEM) was formally established in fall 1981 as a component of the Materials and Molecular Research Division, Lawrence Berkeley Laboratory.

The NCEM provides unique facilities and advanced research programs in the United States for electron microscopy characterization of materials. Its mission is to carry out fundamental research and maintain state-of-the-art facilities and expertise. Present instrumentation at the Center includes a conventional 650 kV Hitachi electron microscope installed in 1969 in the Hearst Mining Building on the University of California Berkeley campus, and a newly installed 1.5 MeV Kratos microscope dedicated largely for in-situ work, a 1 MeV JEOL atomic resolution microscope (ARM) (expected delivery September 1982), with a high-resolution feeder microscope (JEOL 200CX) already operating. In 1983, a 200 kV analytical microscope is expected to be added. Facilities for image simulation, analysis, and interpretation will also be available to users.

USER MODE

Qualified microscopists with appropriate research projects of documented interest to DOE may use the Center without charge. Proprietary studies may be carried out on payment of full costs. Access to the Center may be obtained by submitting research proposals, which will be reviewed for Center justification by a Steering Committee (present external members are Drs. M. Simnad, Chairman, W.L. Bell, D.A. Howitt, J.J. Hren, J.C.H. Spence, and A. Taylor; internal members are G. Thomas, R.M. Glaeser, R. Gronsky, and K.H. Westmacott). A limited number of studies judged by the Steering Committee to be of sufficient merit can be carried out as a collaborative effort between a Center postdoctoral fellow, the outside proposer and a member of the Center staff.

PERSON TO CONTACT FOR INFORMATION

Ms. Madeline Moore (415) 486-5006
National Center for Electron Microscopy FTS 486-5006
Building 72
Lawrence Berkeley Laboratory
University of California
Berkeley, CA 94720

NATIONAL CENTER FOR ELECTRON MICROSCOPY

TECHNICAL DATA

<u>Instruments</u>	<u>Key Features</u>	<u>Characteristics</u>
<p>KRATOS 1.5MeV Electron Microscope</p>	<p>Resolution 3 Å(pt-pt) environmental cell; hot,cold stages</p>	<p>50 hrs/week 150-1500 kV range in 100 kV steps and continuously variable. Max beam current 70 amp/cm². 3mm diameter specimens</p>
<p>Hitachi 650 kV Electron Microscope</p>	<p>General purpose resolution 20 Å environmental cell straining stage</p>	<p>Installed in 1969. Max. voltage 650 kV conventional HVEM</p>
<p>JEOL 200CX Electron Microscope</p>	<p>Dedicated high-resolu- tion 2.4 Å (pt-pt) U.H. resolution goniometer stage only</p>	<p>200 kV only LaB₆ filament 2.3₆mm diameter specimens</p>
<p>JEOL 1 MeV Atomic Resolution Microscope (ARM) (available about March 1983)</p>	<p>Resolution < 1.7 Å (pt-pt) over full voltage range. Ultrahigh resolution goniometer stage, ±40° biaxial tilt with height control</p>	<p>400 kV - 1 MeV 2.3mm diameter specimens</p>
<p>200.kV dedicated Analytical Electron Microscope (planned)</p>	<p>X-ray and energy-loss spectrometers microdiffraction (CB) high-vacuum field emission</p>	<p>100 kV - 200 kV state-of-the-art resolution</p>

ARGONNE NATIONAL LABORATORY HIGH VOLTAGE ELECTRON MICROSCOPE-TANDEM FACILITY

Materials Science Division
Argonne National Laboratory
Argonne, Illinois 60439

The Argonne National Laboratory High Voltage Electron Microscope-Tandem Facility provides unique combinations of the techniques of high-voltage electron microscopy, ion implantation/bombardment, and ion-beam analysis.

The high-voltage electron microscope is an improved Kratos/AEI-EM7 with a maximum voltage of 1.2 MV, and a demonstrated lattice resolution of 3.5 Å. In addition to a 33° ion-beam access tube, the microscope contains a number of specialized features. These include a negative ion trap, an ion-pumped specimen chamber, two independently adjustable dark-field conditions, a 100-1200 kV continuous-mode voltage selection from the control desk, and a beam dosimetry system for both the ion and the electron beams. A variety of side entry single and double tilt stages are available, which permit observations between 10 and 1000 K in vacuo, and from ambient to 1300 K in gaseous environments. Two straining stages are also available for work either in vacuo or in the environmental cell. The ANL HVEM is equipped with a Harwell design camera, and a Cohu video camera and image intensifier are mounted beneath the microscope column.

A National Electrostatics 2 MV Tandem Ion Accelerator and a 300 KV ion accelerator together can produce ion beams from 10 keV to 8 MeV of most stable elements in the periodic table. The tandem unit has two external negative ion sources and a positive ion source in the terminal. Ions from the accelerators can be transported into the microscope through the "ion-beam interface" to permit direct observation of the effects of ions as well as electron bombardment on materials in the HVEM.

USER MODE

The HVEM-Tandem facility is operated as a national materials science resource. Qualified scientists wishing to conduct experiments should submit a proposal to the person named below. Decisions as to which experiments will be done are made by a Program Advisory Committee following peer evaluation of the proposals. There are no use charges for users carrying out basic research of documented interest to DOE. Use charges will be levied for proprietary investigations.

PERSON TO CONTACT FOR INFORMATION

A. Taylor
Manager, HVEM-Tandem Facility
Argonne National Laboratory
9700 South Cass Avenue
Argonne, Illinois 60439

(312) 972-5109
FTS 972-5109

ARGONNE NATIONAL LABORATORY HIGH VOLTAGE ELECTRON MICROSCOPE-TANDEM FACILITY

TECHNICAL DATA

Instrument

KRATOS 1.2 MeV
Electron Microscope

Key Features

Resolution 3.5 Å lattice
Magnification 63-1,000,000X
Continuous voltage selection
Current density 15 A/cm²
High-vacuum specimen chamber
Two switched dark field conditions
Negative ion trap
Electron dosimetry system
Cohu video system
Ion beam access port
Cryogenic anticontaminator

Accelerators

NEC Model 2 UDHS

Terminal voltage - 2 MV
Energy stability - ±250 eV
Current density - H⁺10_μ H/cm²
(typical) Ni⁺¹
Pt^{+0.1}

Texas Nuclear 300-kV

Terminal voltage - 300 kV
Energy stability - ±300 eV
Current density - H⁺20_μA/cm²
(typical) Ni⁺²
Pt⁺²

Ion Sources

Available for both accelerators
Danfysik 910, 911
Sputter
Duoplasmatron

Ion Beams

Any stable isotope

Beam Lines

Ion-beam interface to HVEM
Beamlines and target chambers
for irradiation and in beam
analysis
Duel-ion target chamber

SHARED RESEARCH EQUIPMENT PROGRAM (SHaRE)

Metals and Ceramics Division
Oak Ridge National Laboratory
Oak Ridge, Tennessee 37830

The microanalysis facilities for use in materials science have been made available for collaborative research by members of universities or industry with ORNL staff members. The facilities include state-of-the-art analytical transmission electron microscopy, high voltage electron microscopy, surface analysis, and nuclear microanalysis. The electron microscopy capabilities include high resolution, high voltage, and analytical (energy dispersive X-ray spectroscopy and electron energy loss spectroscopy). Surface analysis facilities include four Auger electron spectroscopy (AES) systems; ion back-scattering and nuclear reaction techniques using the 0.4 and 5.0 MV Van de Graaff accelerators in the Metals and Ceramics Division.

USER MODE

User interactions are through collaborative research projects between users and researchers on the Materials Sciences Program at ORNL. Proposals are reviewed by an executive committee which consists of ORAU, ORNL, and university members. Proposals are evaluated on the basis of scientific excellence and relevance to DOE needs and must identify one ORNL staff member who will share responsibility for the project.

The SHaRE program provides technical help and limited travel expenses for academic participants through the Oak Ridge Associated Universities (ORAU).

PERSONS TO CONTACT FOR INFORMATION

E. A. Kenik	(615) 574-5066
Metals and Ceramics Division	FTS 624-5066
Oak Ridge National Laboratory	
Oak Ridge, Tennessee 37830	

A. Wohlpart	(615) 576-3422
Oak Ridge Associated Universities	FTS 626-3422
P.O. Box 117	
Oak Ridge, Tennessee 37830	

SHARED RESEARCH EQUIPMENT PROGRAM (SHaRE)

Technical Data

<u>Instruments and Facilities</u>	<u>Key Feature(s)</u>	<u>Operating Characteristics</u>
Hitachi HU-1000 High Voltage Electron Microscope	Heating stages; in situ deformation stages; low light level videorecording system; Environmental cell - 0-1 atm	0.3-1.0 MeV; electron irradiation studies. Ten 4-h shifts/week; available evenings, weekends to qualified users
Philips EM400T/FEG Analytical Electron Microscope	TEM resolution <0.16 nm; STEM resolution <1.0 nm; Energy dispersive x-ray analysis; electron energy loss spectroscopy; convergent beam electron diffraction	120 kV; ten 4-h shifts/week; available evenings, weekends, to qualified users; structural and elemental microanalysis; minimum probe diameter < 1 nm
JEOL 120CX Analytical Electron Microscope	TEM resolution ~0.34 nm; STEM resolution ~3 nm; Energy dispersive x-ray analysis; electron energy loss spectroscopy	120 kV; ten 4-h shifts/week; structural and elemental microanalysis; minimum probe diameter < 10 nm
JEOL 120C Transmission Electron Microscope	TEM resolution ~0.34 nm; special polepiece for TEM of ferromagnetic materials	120 kV; ten 4-h shifts/week; structural microanalysis
PHI 590 Scanning Auger Electron Spectroscopy System	200 nm beam size; fracture stage; residual gas analysis; sputter depth profiling; elemental mapping	Surface analytical and segregation studies
Varian Scanning Auger Electron Spectroscopy System	5 μm beam size; hot-cold fracture stage; residual gas analysis; sputter depth profiling; elemental mapping	Surface analytical and segregation studies; gas-solid interaction studies
Dual Ion-Beam Accelerator Facilities	4 MW Van de Graaff accelerator; 400 kV accelerator, sputter depth profiling	Nuclear microanalysis; Rutherford backscattering; elemental analysis

CENTER FOR MICROANALYSIS OF MATERIALS

Materials Research Laboratory
University of Illinois
Urbana-Champaign, Illinois 61801

The Center operates a wide range of advanced surface chemistry and electron-beam microanalytical equipment for the benefit of the University of Illinois materials research community and for the DOE Laboratories and Universities Programs. Equipment is selected to provide a spectrum of advanced micro-characterization techniques including microchemistry, microcrystallography, surface analysis, etc. A team of professionals runs the facility and its members facilitate the research.

USER MODE

Most of the research in the facility is funded by MRL contracts of U of Illinois faculty, and is carried out by graduate students, post-doctoral and faculty researchers and by the Center's own professional staff.

For the benefit of external users the system retains as much flexibility as possible. The preferred form of external usage is collaborative research through a contact with a faculty member associated with the MRL, or by direct negotiation with the management of the Center. Direct user access to the equipment is also possible, for trained individuals. In all cases, the research carried out by facility users has to be in the furtherance of DOE objectives.

The facility staff maintain training programs in the use of the equipment and teach associated techniques. An increasing part of the Center's activity is concerned with the development of new instruments and instrumentation.

A brochure describing the Center and its services is available.

PERSON TO CONTACT FOR INFORMATION

Dr. J. A. Eades, Coordinator
Center for Microanalysis of Materials
Materials Research Laboratory
University of Illinois
104 S. Goodwin
Urbana, Illinois 61801

(217) 333-8396

CENTER FOR MICROANALYSIS OF MATERIALS

TECHNICAL DATA

<u>Instruments</u>	<u>Key Features</u>
Imaging Secondary Ion Microprobe Cameca IMS 3f	Mass analysed images to 0.3 μ resolution 80A depth resolution
Scanning Auger Microprobe Physical Electronics 595	resolution: SEM 300 Å Auger 700 Å Windowless X-ray detector
Scanning Auger Microprobe Physical Electronics 545	resolution: SEM 3 μ specimen temp: 77-600 K
XPS Physical Electronics 548	double pass CMA ESCA and Auger analysis specimen temp to 1500 K
Transmission Electron Microscope Philips EM400 (120 kV)	EDS, STEM heating, cooling stages
Transmission Electron Microscope JEOL 200 (200 kV)	EDX, STEM cooling stage
Scanning Transmission Electron Microscope Vacuum Generators HB5 (100 kV)	5Å probe EDX, EELS
Scanning Electron Microscope JEOL JSM 35C (35 kV)	50Å resolution EDX
Rutherford Backscattering (in-house construction) (3 MeV)	under development
X-ray Equipment Elliott 15 kW high brilliance source Rigaku 12 kW source Several Conventional Sources	4-circle diffractometer small angle camera EXAFS Lang topography powder cameras etc.

In addition to the main items listed above the Center also has other equipment: second scanning electron microscope, two electron microprobes, a spark source mass spectrometer optical microscopes, a surface profiler, a microhardness tester, etc. Dark rooms and full specimen preparation facilities are available, including five ion-milling stations, evaporators, electropolishing units, sputter coaters, a spark cutter, an acid saw, etc.

The equipment is made available on a flexible week-by-week booking scheme; if professional help is required, operating hours are 8-5, except by special arrangement. Fully qualified users can and do use the equipment at any time of day. Several of the instruments are maintained in almost continuous (24 hour) use.

SURFACE MODIFICATION AND CHARACTERIZATION LABORATORY

Solid State Division
Oak Ridge National Laboratory
Oak Ridge, Tennessee 37830

This program utilizes a new approach for fundamental materials research. The combined techniques of ion implantation doping, ion induced mixing and pulsed-laser processing are utilized to alter the near-surface properties of a wide range of solids in ultrahigh vacuum. Through in situ analysis by ion beam, surface, and bulk properties techniques, the fundamental materials interactions leading to these property changes are determined. Since both ion implantation doping and pulsed-laser annealing are nonequilibrium processing techniques, they can be used to produce new and often unique materials properties not possible with equilibrium fabrication techniques. This makes them ideal tools for fundamental materials research. They are equally useful for modifying surface properties for practical applications in areas such as friction, wear, corrosion, catalysis, surface hardness, solar cells, semiconducting devices, superconductors, etc.

This program has emphasis on long-range basic research. Consequently, most collaborative research involving scientists from industry, universities and other laboratories has been the investigation of new materials properties possible with these processing techniques or the determination of the mechanisms responsible for observed property changes. In most instances such research projects identify definite practical applications and accelerate the transfer of these materials alteration techniques to processing applications.

USER MODE

User interactions are through mutually agreeable collaborative research projects between users and research scientists at ORNL which utilize the unique alteration/analysis capabilities of the facility. Because of the tremendous interests expressed in these techniques and the broad range of existing collaborations, plans for a users' facility have been initiated. Until this program has been established, the informal arrangement will be continued. It should be emphasized that the goal of these interactions is to demonstrate the usefulness or feasibility of these techniques for a particular materials application and not to provide routine service alterations or analyses.

PERSON TO CONTACT FOR INFORMATION

B. R. Appleton or C. W. White

(615) 574-6283
FTS 624-6283

Solid State Division
Oak Ridge National Laboratory
Oak Ridge, Tennessee 37830

SURFACE MODIFICATION AND CHARACTERIZATION LABORATORY

TECHNICAL DATA

Accelerators

2.5 MV Positive Ion Van de Graaff

10-200 KV High Current Ion
Implantation Accelerator

0.1-10 KeV Ion Gun

Lasers

Pulsed Ruby Laser (0.6943 μm)

Pulsed Ruby Laser (0.6943 μm)

Pulsed Nd:YAG/Glass Laser

Wavelengths: 1.06 μm , 0.530 μm ,
0.353 μm , 0.265 μm

Pulsed Excimer Laser (0.308 μm)

Facilities

UHV Surface and Near-Surface
Analysis Chambers

In Situ Analysis Capabilities

Combined Ion Beam and Laser
Processing

Dual Simultaneous Ion Beam
Irradiations

Operating Characteristics:

0.1-3.2 MeV. H, D, ^4He , ^3He and
selected gases. Beam current
 ~ 50 μamps .

Essentially any species of ion.
1-10 mamps single charged, ~ 100 μamps
doubly and triply charged.

Gaseous species. ~ 100 μamp .

15-30 $\times 10^{-9}$ s pulse duration time.
10 Joule/Pulse Output Multimode,
2-1/2 Joule/Pulse Output Single Mode
(TEM_{00}).

15-30 $\times 10^{-9}$ s pulse duration time.
8 Joule/Pulse Output Single Mode
(TEM_{00}).

15 $\times 10^{-9}$ s. 20 Joule/Pulse (1.06 μm),
5 Joule/Pulse (0.530 μm),
1 Joule/Pulse (0.265 μm).
30, 50, 100 or 0.7 Joule/Pulse (1.06 μm)
200 $\times 10^{-12}$ s. 0.2 Joule/Pulse (0.530 μm),
0.07 Joule/Pulse (0.265 μm).

20 $\times 10^{-9}$ s. 1.5 Joule/Pulse

Several chambers. Vacuums 10^{-6} - 10^{-11}
Torr. Multiple access ports. Liquid
helium cryostat, UHV goniometers (4-1300 K).

Ion scattering, ion channeling, ion
induced nuclear reactions and
characteristic x-rays. LEED, Auger,
ion induced Auger. Optical emissions
from sputtered particles. Laser
Fluorescence Spectroscopy. Electrical
resistivity versus temperature.

Laser and ion beams integrated into
same UHV chambers.

Combined accelerator irradiations.

COMBUSTION RESEARCH FACILITY - MATERIALS PROGRAM

Sandia National Laboratory
Livermore, California 94550

Optical diagnostics, primarily spontaneous Raman spectroscopy, are being developed and used to study high temperature corrosion and erosion of materials for combustion systems. Emphasis is on the use of these techniques to identify chemical compounds present on surfaces during attack in hostile environments. In-situ analyses can be obtained with excellent temporal resolution (approximately 10 spectra per second) from samples in high temperature corrosive environments. These measurements are complemented by post-exposure Raman measurements including a Raman microprobe which allows analysis with micron spatial resolution. Other techniques including Sputter Induced Photon Spectroscopy (SIPS), Scanning Auger Microscopy (SAM), X-ray diffraction, and metallographic analysis provide complementary compositional and morphological information. Present research concerns include oxidation-sulfidation of Fe-Cr and Fe-Mn-Al alloys, chemical attack of stabilized zirconia thermal barrier coatings, corrosion of ion-implanted metals, and combined oxidation-erosion of steel. The goal is to obtain information about attack mechanisms utilizing data obtained during the corrosion processes.

Equipment which is available in a collaborative mode includes the atmospheric combustion exhaust simulator (ACES) which produces an environment for realistic corrosion/erosion studies with capability for in-situ Raman analysis. ACES provides a high velocity (50 feet per second), high temperature (1000°C) gas flow with provision for particulate injection. This apparatus is being used for in-situ Raman studies and for erosion experiments.

USER MODE

This materials program at Sandia has emphasized research into corrosion and erosion mechanisms using the techniques and equipment described above. Interactions include collaborative research projects with outside users and providing information on new diagnostic approaches to the study of corrosion. In initiating collaborative research projects it is generally desirable to perform preliminary Raman analyses of typical samples and of reference materials to determine sensitivity to expected corrosion products. Subsequently, a brief written proposal is requested. Generally, visits of a week or more for external users provide an optimum period for information exchange and joint research efforts. Users from industrial, university, and government labs have been involved in these collaborative efforts. Results of these research efforts are published in the open literature.

PERSON TO CONTACT FOR INFORMATION

Walter Bauer
Department 8340
Sandia National Laboratory
Livermore, California 94550

(415) 422-2994
FTS 532-2994

COMBUSTION RESEARCH FACILITY - MATERIALS PROGRAM

TECHNICAL DATA

Instruments

Key Features

Raman Spectrometer

Rejects elastic light
to within 100 cm^{-1} of
laser time.

100 ms. temporal
resolution.

Raman Microprobe

1 micron spatial
resolution.

Sputter Induced Photon
Spectroscopy (SIPS)

5 keV argon beam
surface analysis of
insulators.

Atmospheric Combustion
Exhaust Simulator

50 fps flow
1000°C temperature
Particulate injection

MATERIALS PREPARATION CENTER

Ames Laboratory
Iowa State University
Ames, Iowa 50011

The Materials Preparation Center was established because of the unique capabilities for preparation, purification and fabrication of certain metals and materials that have been developed by investigators at the Ames Laboratory during the course of their basic research. Individuals within the Laboratory's Metallurgy and Ceramics Program are widely recognized for their work with very pure rare-earth, alkaline-earth and refractory metals. Besides strengthening materials research and development at the Ames Laboratory, the Center increases awareness by the research community of the scope and accessibility of this resource to universities, other government and private laboratories and provides appropriate transfer of unique technologies developed at the Center to private, commercial organizations.

Through these research efforts at Ames, scientists are now able to acquire very high-purity metals and alloys in single and polycrystalline forms, as well as the sophisticated technology necessary to satisfy many needs for special preparations of rare-earth, alkaline-earth, refractory and some actinide metals. The materials in the form and/or purity are not available from commercial suppliers, and through its activities the Center helps assure the research community access to materials of the highest possible quality for their research programs.

USER MODE

Quantities of ultrapure rare-earth metals and alloys in single and polycrystalline forms are available. Special preparations of high-purity oxides and compounds are also available in limited quantities. Unique technologies developed at Ames Laboratory are used to prepare refractory metals in single and polycrystalline forms. In addition, certain alkaline-earth metals used as reducing agents are available. Materials availability information can be obtained from Frederick A. Schmidt, Operations Manager, Materials Preparation Center.

PERSON TO CONTACT FOR INFORMATION

Frederick A. Schmidt
Materials Preparation Center
121 Metals Development Building
Ames Laboratory
Ames, Iowa 50011

(515) 294-5236
FTS 865-5236

MATERIALS PREPARATION CENTER

TECHNICAL DATA

Materials

Scandium
Yttrium
Lanthanum
Cerium
Praseodymium
Neodymium
Samarium
Europium
Gadolinium
Terbium
Dysprosium
Holmium
Erbium
Thulium
Ytterbium
Lutetium

Titanium
Vanadium
Chromium
Manganese
Zirconium
Niobium
Molybdenum
Hafnium
Tantalum
Tungsten

Magnesium
Calcium
Strontium
Barium

Thorium
Uranium

LOS ALAMOS EQUATION OF STATE LIBRARY CENTER

Los Alamos National Laboratory
Los Alamos, New Mexico 87545

The Los Alamos Equation of State (EOS) Library is a computer-based library of EOS data and FORTRAN subroutines developed at Los Alamos. It is used nationally and internationally by many Laboratories, universities, research institutes and private corporations. The Library is becoming a standard reference resource for EOS and related data.

The Library contains EOS tables of pressure and internal energy as functions of temperature and density for approximately 50 different materials. The tabular format has several advantages: (1) it can represent phase transitions accurately, (2) it covers a wide range of temperatures and densities, and (3) it is easily updated to incorporate new experimental or theoretical results in specific regions of temperature and density. All types of materials are tabulated, including gases, metals, ceramics, plastics, glasses, and even composites such as rocks and minerals.

The associated subroutine library contains programs to update and retrieve data for a given material as well as accurate interpolation schemes for that data. These subroutines can be used directly in the user's computer program and have been incorporated in a number of Lagrangian and Eulerian fluid dynamic codes. The tables are sent from Los Alamos to other institutions on magnetic tapes, in a format that can be interpreted even if the other installation has a computing system different from that at Los Alamos. In most cases, the user can begin to apply the new table to a problem without having to analyze, interpret, or adapt it to his particular needs. Information about the availability of new data is communicated to users by journal articles, reports, informal newsletters, and by personal contact.

The EOS tables usually cover a much wider range of pressure and temperature than can be studied by experimental methods. To construct the tables, it is necessary to employ theoretical models of solids, liquids, vapors, and plasmas, for mixtures and chemical compounds as well as pure elements. EOS tables of high standard from sources other than Los Alamos, even though of more restricted pressure-temperature ranges, are also incorporated in the Library. Other related material properties, such as radiative opacities and conductivities, will be made available in the near future.

USER MODE

The Los Alamos EOS Library is available to users free of charge. To obtain the Los Alamos EOS Library, a user should send a list of materials required and two magnetic tapes with write format specification to

SESAME Library, T-4, MS B212
Los Alamos National Laboratory
Los Alamos, New Mexico 87545

PERSON TO CONTACT FOR INFORMATION

Stanford P. Lyon
MS-B212

(505) 667-7024
FTS 843-7024

Los Alamos National Laboratory
Los Alamos, New Mexico 87545

TECHNICAL DATA

Materials

alumina
aluminum
argon

methane
mica
molybdenum

beryllium
boron carbide
brass

neon
Nevada alluvium
nickel
nitrogen

carbon liquid
carbon phenolic
copper

oxygen

deuterium
diamond
dry air
D-T-He mixture

PBX-9502
platinum
polyethylene
polystyrene
polyurethane

gold

quartz

helium
high explosive
hydrogen

Ross-Aller solar mix

iron

salt
sodium
stainless steel
steam
steel

krypton

tungsten
tungsten carbide

lead
lithium
lithium deuteride
lithium hydride

uranium
uranium dioxide

water
westerly granite

*The EOS Library is a unique source of data that is utilized internationally. Although it is not a comparable research center with those previously given, it is included for your information.

HIGH TEMPERATURE MATERIALS LABORATORY AND CERAMIC
SPECIMEN PREPARATION AT OAK RIDGE NATIONAL LABORATORY

VICTOR J. TENNERY
OAK RIDGE NATIONAL LABORATORY

ORNL WS-23331

**HIGH TEMPERATURE MATERIALS LABORATORY AND
CERAMIC SPECIMEN PREPARATION AT
OAK RIDGE NATIONAL LABORATORY**

V. J. TENNERY

**EMACC MEETING ON PROBLEMS AND OPPORTUNITIES IN
STRUCTURAL CERAMICS
GERMANTOWN, MD
SEPTEMBER 29, 1982**

HIGH TEMPERATURE MATERIALS LABORATORY STATUS

- PROPOSED NEW FACILITY FOR HIGH TEMPERATURE MATERIALS RESEARCH
- CONSTRUCTION PROJECT AT ORNL
- PROJECT ADVOCATED BY DIVISION OF MATERIALS SCIENCES, OBES, DOE
- 43,000 ft² FACILITY
- ESTIMATED COST IS 20.6 M\$ IN FY 84

HTML WILL HAVE FOUR MAJOR CHARACTERISTICS

- **BASIC AND APPLIED RESEARCH ON CERAMIC AND ALLOY MATERIALS CONDUCTED IN SAME FACILITY**
- **LABORATORY WILL CONTAIN VARIETY OF SPECIAL EQUIPMENT FOR HIGH TEMPERATURE MATERIALS RESEARCH**
- **INDUSTRIAL USERS WILL BE ENCOURAGED TO USE LABORATORY FOR CONDUCTING RESEARCH**
- **UNIVERSITY USERS WILL BE ENCOURAGED TO CONDUCT RESEARCH IN LABORATORY ON SHORT-TERM AND LONG-TERM BASIS**

**IN FY 1983 SIX MATERIALS SCIENCES RESEARCH TASKS AT
ORNL INVOLVE CERAMICS**

	TITLE	EST. PY	DIVISION
1.	MECHANICAL PROPERTIES OF CERAMICS	4	M & C
2.	RESEARCH ON CERAMIC PROCESSING	3	M & C
3.	THERMODYNAMICS OF ENERGY RELATED SYSTEMS	2.5	CHEM. TECH.
4.	HIGH TEMPERATURE CHEMISTRY OF STRUCTURAL MATERIALS	5.5	CHEMISTRY
5.	HIGH TEMPERATURE CERAMIC MATERIALS	9	SOLID STATE
6.	PREPARATION AND CHARACTERIZATION OF RESEARCH MATERIALS	4	SOLID STATE
	TOTAL	28	

**IN FY 1983 FIVE MATERIALS SCIENCES RESEARCH TASKS AT
ORNL INVOLVE HIGH TEMPERATURE ALLOYS**

	TITLE	EST. PY	DIVISION
1.	DEFORMATION AND FRACTURE OF ALLOYS	5	M & C
2.	SOLID STATE REACTIONS AND PHYSICAL PROPERTIES	12	M & C
3.	FUNDAMENTALS OF WELDING AND JOINING	3	M & C
4.	HIGH TEMPERATURE ALLOY DESIGN	1	M & C
5.	PREPARATION AND CHARACTERIZATION OF RESEARCH MATERIALS	1.5	SOLID STATE
	TOTAL	22.5	

SIX CAPABILITIES AT ORNL FOR PREPARATION OF CERAMIC MATERIALS ARE ILLUSTRATED

1. SOL-GEL POWDER SYNTHESIS
 - SINGLE OXIDES, $\text{Al}_2\text{O}_3\text{-ZrO}_2$, $\text{Al}_2\text{O}_3\text{-HfO}_2$, $\text{ZnO-B}_2\text{O}_3$, SiC
 - MAX. BATCH SIZE \cong 0.5 kg
2. CVD OF COATINGS AND POWDERS
 - SiC, TiB_2 , OTHER CARBIDES AND BORIDES
 - REACTOR DIAMETERS TO 15 cm
 - MAX. TEMP. \cong 1800°C
3. INERT ATMOSPHERE UNIAXIAL HOT PRESSING
 - OXIDES, CARBIDES, NITRIDES, AND BORIDES
 - MAX. DIAM \cong 15 cm
 - MAX. PRESSURE \cong 34 MPa AT 2000°C
4. INERT OR NEUTRAL ATMOSPHERE SINTERING
 - OXIDES, CARBIDES, BORIDES
 - MAX. DIAM \cong 10 cm
 - MAX. TEMP. \cong 2200°C

SIX CAPABILITIES AT ORNL FOR PREPARATION OF CERAMIC MATERIALS ARE ILLUSTRATED (CONT'D)

5. OXIDIZING ATMOSPHERE SINTERING

- OXIDES
- MAX. DIAM \cong 5 cm
- MAX. TEMP. \cong 1850°C

6. SINGLE CRYSTAL AND EUTECTIC GROWTH

- β Al₂O₃, R. E. ORTHOPHOSPHATE, AND NIOBATE XLS
- BORIDE-OXIDE AND OXIDE-OXIDE EUTECTICS

CZOCHEWALSKI 100 ATM, NEUTRAL OR INERT,
 $T_{MAX} \cong 2100^{\circ}\text{C}$, MAX. DIAM \cong 3 cm

BRIDGMANN ~ 1 ATM, NEUTRAL OR INERT,
 $T_{MAX} \cong 1900^{\circ}\text{C}$, MAX. DIAM \cong 3 cm

SKULL MELTING ~ 1 ATM, INERT OR OXIDIZING,
 $T_{MAX} \cong 2700^{\circ}\text{C}$, MAX. DIAM \cong 2 cm

CAPABILITIES FOR CERAMIC SPECIMEN PREPARATION AND
CHARACTERIZATION AT LOS ALAMOS NATIONAL LABORATORY

JOHN J. PETROVIC
LOS ALAMOS NATIONAL LABORATORY

CAPABILITIES FOR CERAMIC SPECIMEN
PREPARATION AND CHARACTERIZATION
AT THE LOS ALAMOS NATIONAL LABORATORY

J. J. PETROVIC
F. D. GAC
J. V. MILEWSKI
C. HOLLABAUGH
L. R. NEWKIRK
D. E. HULL

Los Alamos

CAPABILITY HIGHLIGHTS

- CERAMIC FABRICATION FACILITIES
- RF-PLASMA SYSTEM FOR PRODUCTION OF SiC AND Si₃N₄ POWDER
- SiC AND Si₃N₄ WHISKER GROWTH AND CHARACTERIZATION CAPABILITIES
- MECHANICAL TESTING FACILITY FOR CERAMIC FRACTURE RESPONSE UNDER MULTIAXIAL LOADING

Los Alamos

CERAMIC FABRICATION CAPABILITIES

- HOT PRESSING
- HOT ISOSTATIC PRESSING
- COLD ISOSTATIC PRESSING
- COLD DIE PRESSING
- INJECTION MOLDING
- SLIP CASTING/EXTRUSION
- GLASS/GLASS-CERAMIC FORMULATION
- POWDER/BULK PROPERTY CHARACTERIZATION
- PLASMA/FLAME SPRAYING
- HIGH TEMPERATURE SEALING
- SINGLE CRYSTAL GROWTH
- WHISKER GROWTH
- COATING TECHNOLOGY
- MICROWAVE PROCESSING
- COMPLETE FURNACE CAPABILITIES
- BRITTLE MATERIAL DESIGN



**HOT PRESSING
DIE ASSEMBLY**

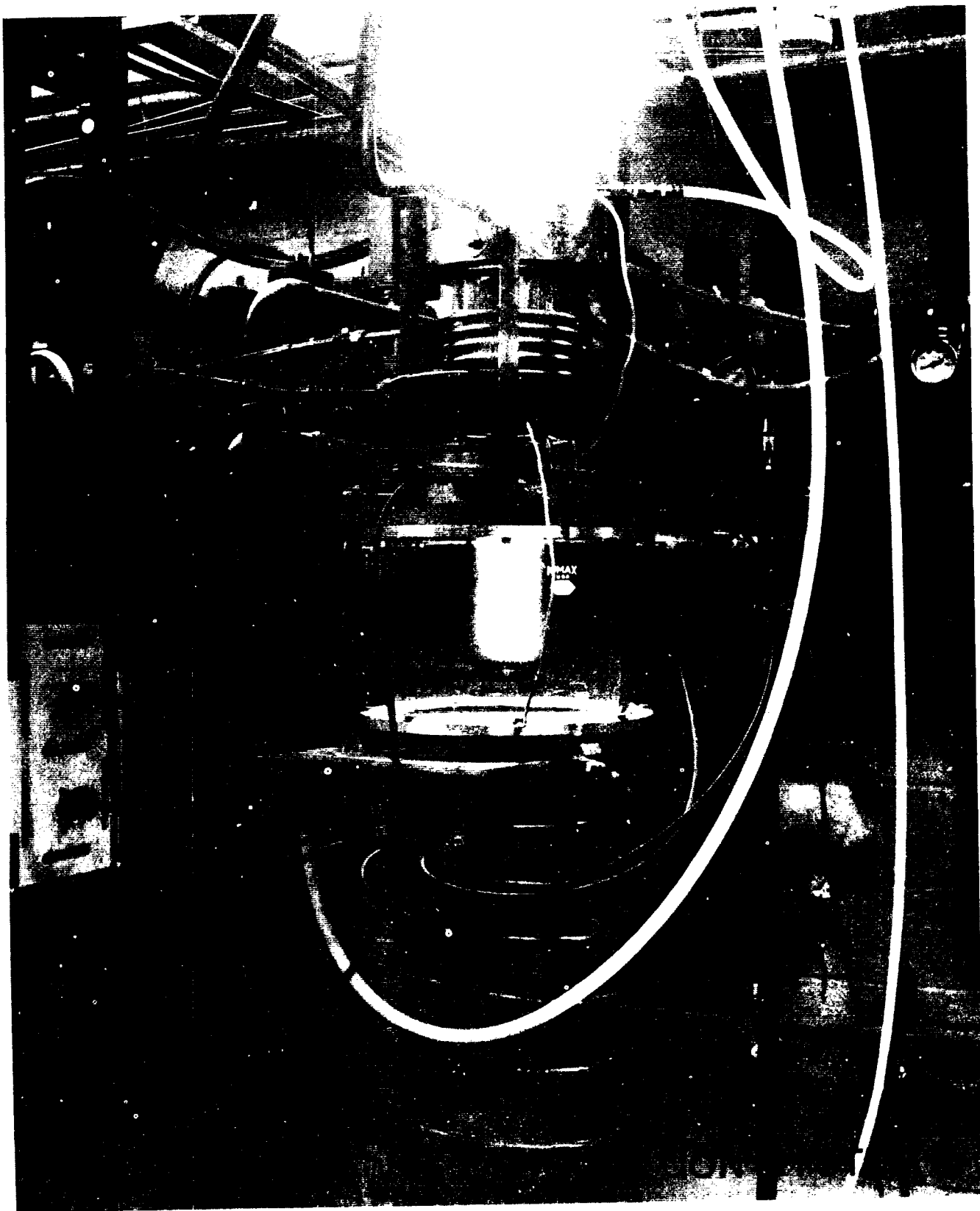

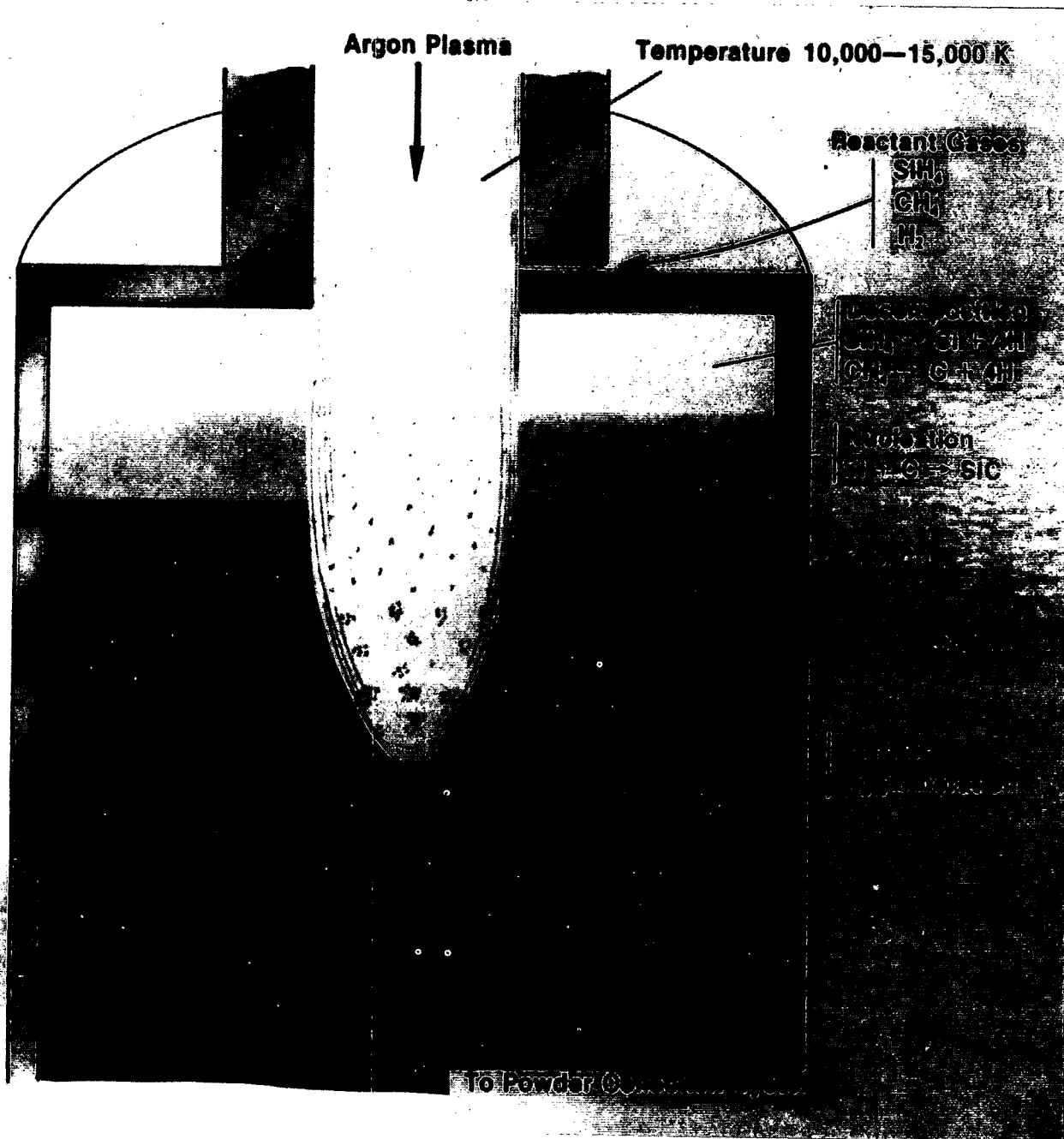



— 1000 Å

Los Alamos

RF-PLASMA SiC POWDER

METAL CATALYST BALL ON TOP OF
BETA SILICON CARBIDE WHISKER
ILLUSTRATES V.L.S. GROWTH



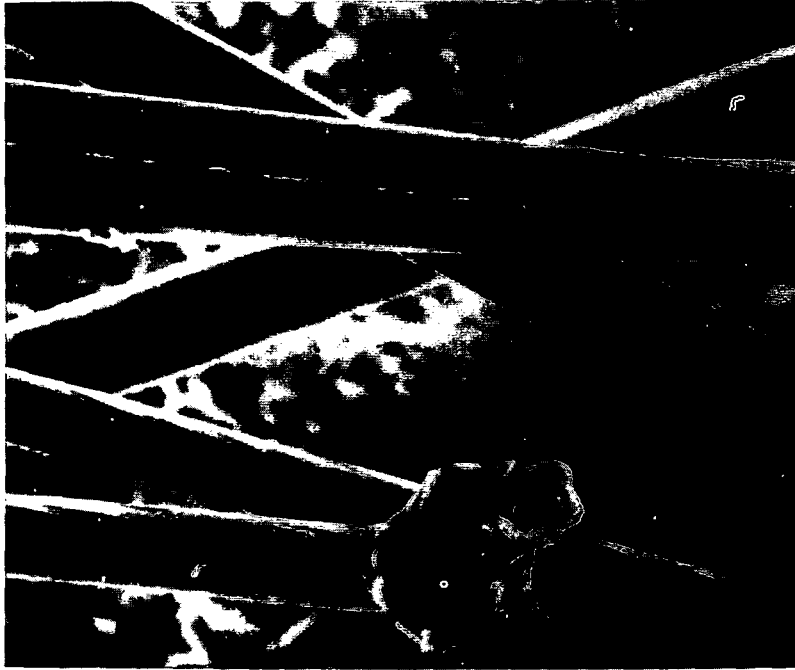

**Si C
WHISKERS**

20 μ m



**Si₃ N₄
WHISKERS**

20 μ m

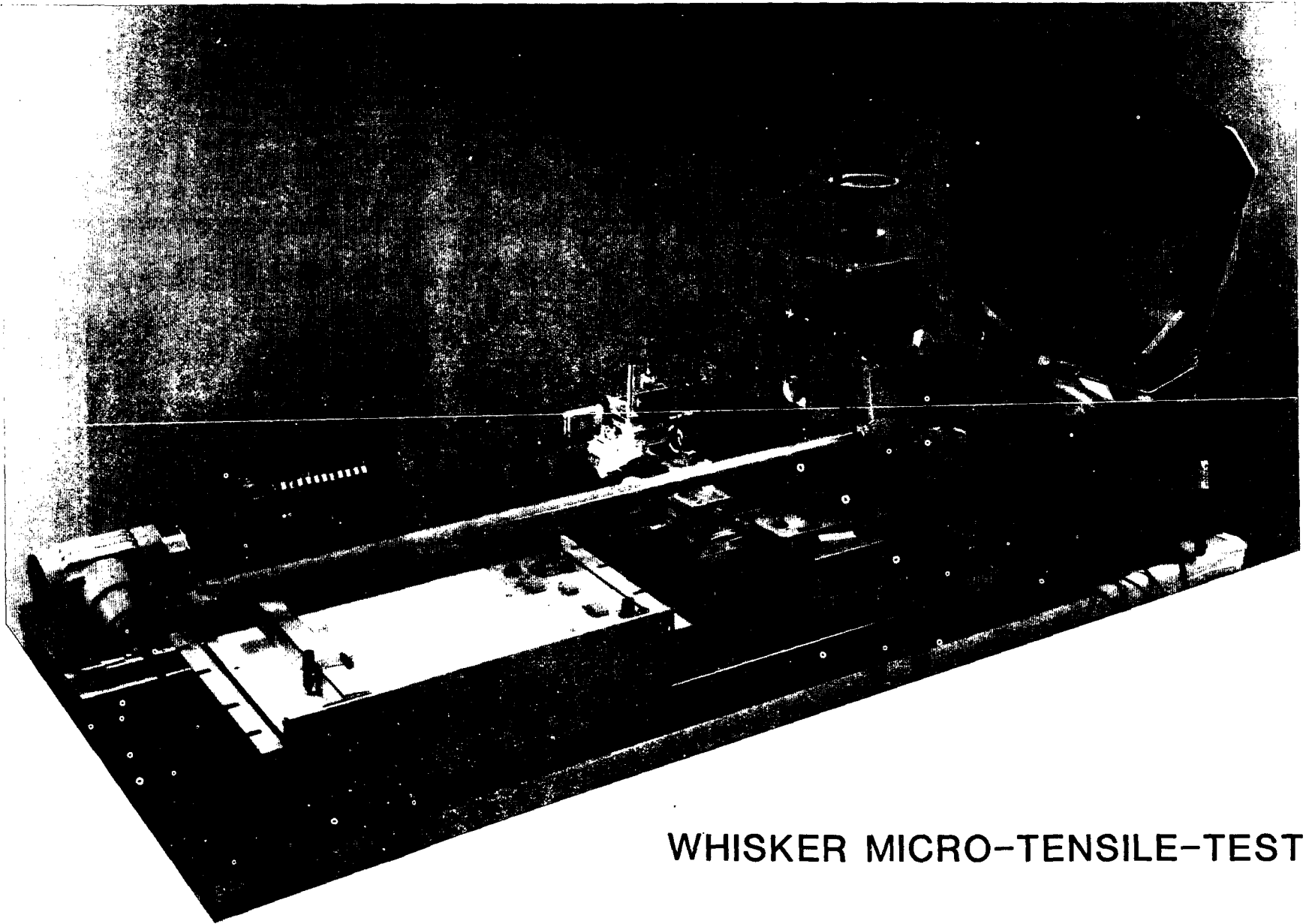

WHISKER MICRO-TENSILE-TESTER



10 μm

TESTED SiC
WHISKER



5 μm

SiC WHISKER MECHANICAL PROPERTIES

- 5–10 μm WHISKER DIAMETER AND 5 mm TESTED WHISKER LENGTH
- FRACTURE STRESS: 9.05 GPA (1,310,000 Psi)
- ELASTIC MODULUS: 688 GPA (99,800,000 Psi)
- ELASTIC FRACTURE STRAIN: 1.37%

Los Alamos

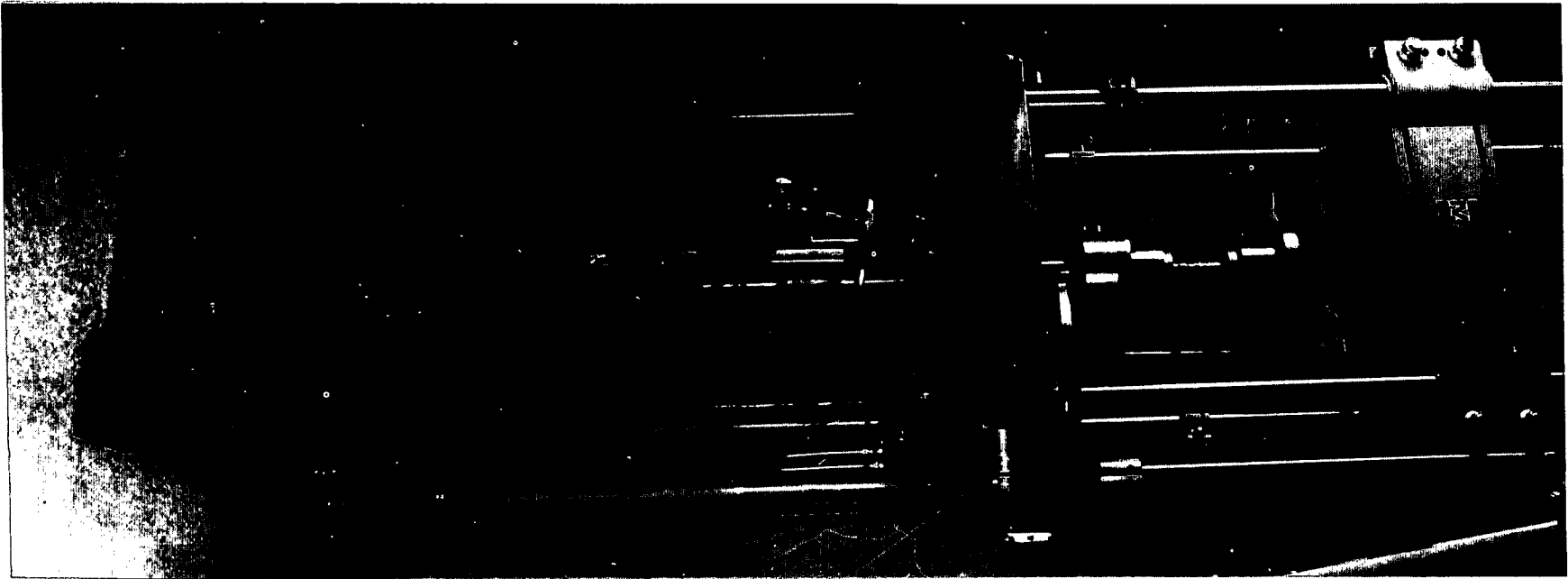

MULTIAXIAL LOADING TEST FACILITY

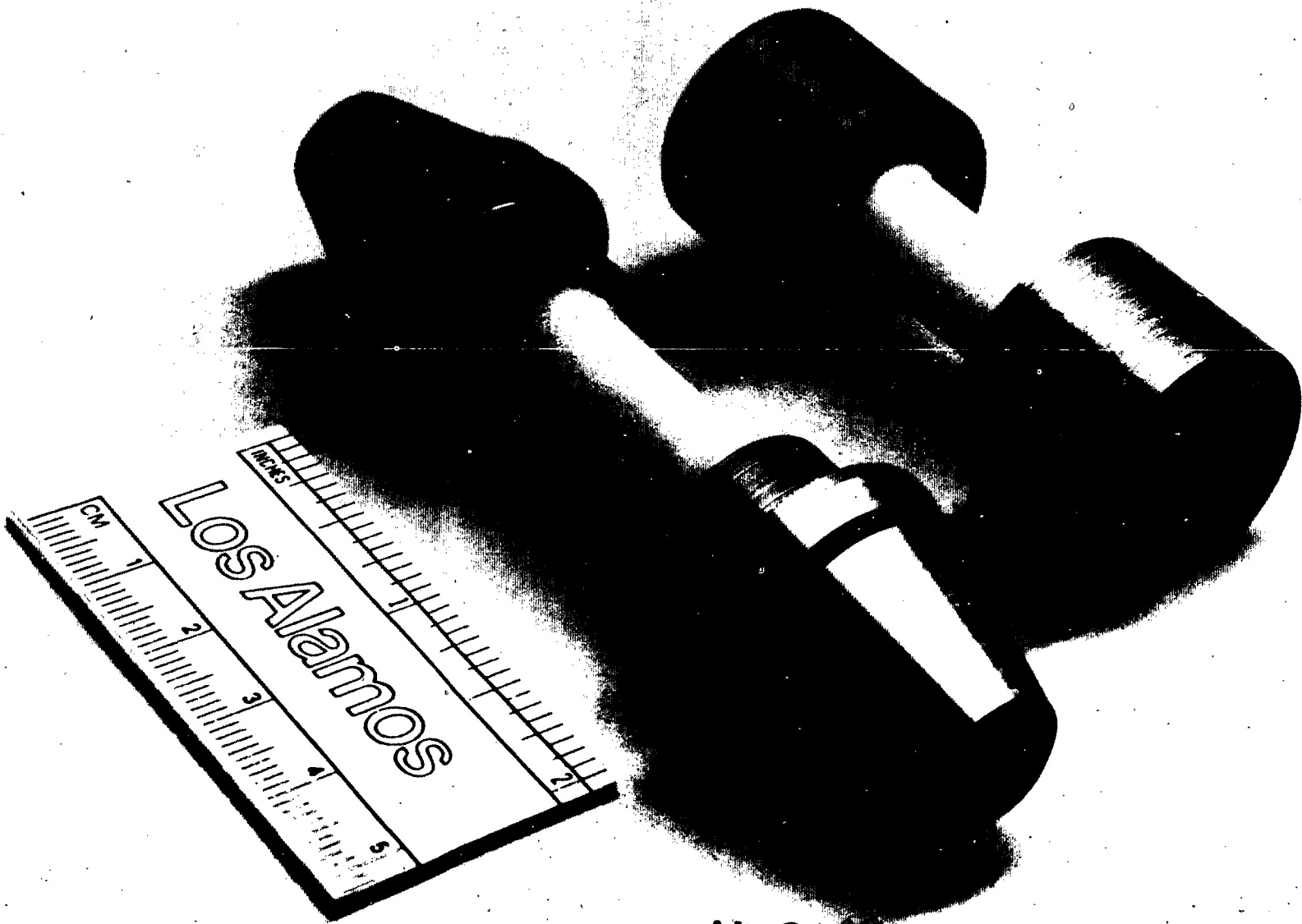

AL₂O₃ TUBE TEST SPECIMENS

PANEL DISCUSSION ON NEW DIRECTIONS FOR FABRICATION RELIABILITY

Moderator: Roy W. Rice (Naval Research Laboratory)
Panelists: Richard J. Charles (General Electric Corp.)
Peter W. Heitman (Detroit Diesel Allison of
General Motors)
Frederick F. Lange (Rockwell International)
Carr Lane Quackenbush (General Telephone and Electronics)
David W. Richerson (AiResearch Manufacturing Co.)
Richard C. Phoenix (Carborundum Co.)

This Panel was concerned with innovative approaches to powder preparation and consolidation processes from the perspectives of research, ceramic producers, and engine manufacturers. Subjects considered were

- o Powder synthesis: Topics discussed were organo-metallic, organo-ceramic, and polymer precursors; sol-gel processes; spacially controlled gas phase reactions, laser assisted reactions, precipitation processes (solid from liquid), solid state reactions, de-agglomeration, flocculation. Application of extensive existing knowledge on ceramic oxide precursors to the synthesis of carbide and nitride powders was emphasized. Critical analytical needs to characterize carbide and nitride powders in the green state were identified. Organic and inorganic carrier systems were contrasted.

Special concerns included raw materials and the need for "better and more reproducible powders". Discussion topics included sampling from a large batch of powder, the total characterization of sub-micron powder, agglomeration behavior and effects and their relationship to surface chemistry. Desirable interactions could occur between commercial suppliers and users of powder. Are present powder characterization procedures adequate? Do we have enough understanding to write optimal specifications for powder? Ceramic processors need to call in and interact with the disciplines of inorganic chemistry. It was alleged that "the future of ceramics rests on better chemistry".

Alternative powder synthesis was also discussed. Does CVD powder synthesis warrant further attention? What is the origin in the large residual stress in CVD deposited SiC powder? Why is there so little basic research on (1) fusion, (2) flame spray, and (3) CVD processes dedicated to the synthesis of powders of structural ceramics?

- o Forming: Topics discussed were powder packing, organic vehicle molding (injection molding), CVD and assisted CVD, and clean room processing. The most promising forming methods for producing dense structural ceramics having high reliability, i.e. highly controllable average fast-fracture strength and Weibull modulus, were identified. CVD is a viable near net shape process for structural

ceramic engine components. Critical research needs for the (assisted) CVD of structural ceramics with engineering dimensions were identified.

Special concerns included the need for rheological studies to underpin research and development involving organic vehicle molding. Another identified need was to consider alternative molding techniques. Strain rate sensitivity is a problem in injection molding, and this problem is made more severe because variable cross-sections or thicknesses within a component give rise to variable strain rates within it. The injection molding process must be designed so as to avoid cavitation.

Dry green pressing may produce agglomerates. The synergisms and variables related to the use or application of (1) plasticizers, (2) non-spherical powder packing, and (3) colloidal methods were discussed. How can one work with a polymer system to disperse particles and avoid agglomeration?

The possibility of colloidal binders was discussed. The consensus was unanimous that there is no such thing as a universal binder. The discussion emphasized polymeric binders.

- o Densification: Discussion topics were sintering aids, pressure-temperature equilibria, mechanical pressure aids (HIPing, gas-pressure sintering, dynamic compaction), radiation induced metamictization and surface activation, reaction sintering vs. rapid sintering vs. isothermal sintering, quantitative schemes to measure microstructural and microchemical variability. The intrinsic flaw populations in structural ceramics can be changed substantially for the better by improved understanding and control of the densification (sintering) process compared to the present state of affairs. R&D approaches which offer the greatest potential for providing significant advances were identified.

Dilatometric means for monitoring the sintering process were discussed. The lack of large-volume furnaces for sintering components with engineering dimensions was noted. This was considered to be problem for the furnace manufacturers, and not a materials problem.

- o Finishing: Discussion topics were electric discharge machining (for SiC), laser machining, grinding, polishing, surface repair, chemical and electrochemical processes, coatings, and surface modification treatments. The role of extrinsic flaws (i.e. machining damage) determines reliability and must be controlled via careful application of surface finishing processes. The amount and character of near-surface residual stresses must also be controlled within design tolerances.

There have been few studies relating machining variables to microstructural parameters, and very little information exists

concerning the effects of abrasive machining on the microstructure of structural ceramics.

The effects of laser machining on the strength of structural ceramics was discussed. Typically laser machining results in a 50% strength loss for Si_3N_4 , so it was suggested that while there might be special niches of application of laser machining to structural ceramics, there is unlikely to be a widespread use. One panelist commented, however, that the problem with laser machining is that we don't yet know how to do it.

- o Manufacturing quality assurance: Topics discussed were the adequacy of the present state-of-the-art of physical acoustics and acoustic microscopy, small angle scattering techniques for porosity characterization, analytical electron microscopy for grain boundary microchemistry, and the identification of R&D approaches for NDE which offer the greatest potential of assuring fabrication reliability.

NDE methods are needed to establish a correlation between various process steps and the development of flaws. Flaw origins in structural ceramics are often related to the differential sintering of agglomerates, so that there is need for an NDE method to detect such agglomerates in green powder.

Crucial issues that relate to quality control and manufacturing cost are (1) the detection limits of NDE, (2) the precision with which defects can be located within the component, (3) the precision with which the origin of the defect can be located within the manufacturing sequence and (4) the probabilistic-statistical level of safe-operating applied stress that is associated with a given defect.

- o General issues: Discussion concerns included
 - o Balancing efforts so as to refine existing fabrication methods while developing new ones
 - o Relating the more extreme process parameters and unique hardware of basic research to the limited process parameters and more common hardware of manufacturing. Sharing of unique equipment and facilities (i.e., hot press, clean room, etc.)
 - o Coordination between fabrication research and manufacturing groups. Inertia in initiating fundamental and innovative science (to obtain understanding) on complex technological materials and processes.
 - o Bringing together collaborative groups with special expertise and resources while upholding proprietary and patent interests.

PANEL DISCUSSION ON CIVILIAN MARKET ANALYSIS FOR STRUCTURAL CERAMICS

Moderator: John W. Fairbanks (DOE)

Panelists: Lawrence R. Johnson (Argonne National Laboratory)
James I. Mueller (University of Washington)
Karsten H. Styhr, Jr. (AirResearch Casting Co.)

This Panel was concerned with the identification of parameters that have implications for future research directions. Issues discussed included

- o Domestic availability of raw powder from the perspectives of suppliers and users.
- o Domestic processing capacity vs. potential need.
- o Implications of recognition that not all structural ceramics are alike, and that ultimate technological applications may invoke a mix of different materials.
- o Implications of recognition that not all devices containing structural ceramics are similar. Distinctions between gas turbine, diesel, Stirling, turbocharger, and other high temperature structural applications.
- o Implications of the strategic and critical nature of competitive materials.
- o How might the large-scale use of near-net-shape materials possibly influence industrial structure?
- o What are the appropriate parameters and variables to incorporate in a market analysis?

AN OVERVIEW OF THE MARKET POTENTIAL FOR STRUCTURAL CERAMICS

Larry R. Johnson
Center for Transportation Research
Building 362
Argonne National Laboratory
Argonne, IL 60439

POTENTIAL MARKETS FOR STRUCTURAL CERAMICS

NEAR-TERM
(CURRENT PLUS 5 YEARS)

WEAR PARTS

SEALS (HP-SCRATCH RESISTENT)
BEARINGS (BALL AND ROLLER)
VALVES
NOZZLES
LINERS
PADS
GATES
SLIDES

CUTTING TOOLS

TIPS

ABRASIVES

CORROSION RESISTANT PARTS

PIPING
VALVES
SEALS
GASIFIER COMPONENTS (COAL)
COATINGS

HEAT ENGINE APPLICATIONS

DIESEL WEAR PARTS
- PUSHRODS
- TAPPETS
- SEALS
TURBINE THERMAL BARRIER COATINGS
BRAIDABLE SHROUDS

HIGH STIFFNESS-TO-WEIGHT STRUCTURAL

FIBER REINFORCED SPARS
TILES
CASTINGS

POTENTIAL MARKETS FOR STRUCTURAL CERAMICS
INTERMEDIATE-TERM
(BY YEAR 2000)

MORE (IN QUANTITY AND QUALITY) OF NEAR-TERM PRODUCTS

HEAT EXCHANGER COMPONENTS

METAL MELTING FURNACES
GLASS MELTING FURNACES
COAL BURNING FURNACES
INCINERATORS

NEW REFRACTORIES

HEAT ENGINE APPLICATIONS

DIESEL COMBUSTION ZONE
- CYLINDERS
- PISTON CAPS
ADIABATIC DIESEL
TURBOCHARGER ROTORS
TURBINE STATIC PARTS
- COMBUSTORS
- SHROUDS
TURBINE ROTATING PARTS
- MISSILES
SENSORS AND PROBES

GUN BARREL LINERS

NON-ENGINE MISSILE PARTS

RADOMES
IR DOMES
CONTROL VALVES

CORROSION RESISTANT PARTS

SYNFUEL APPLICATIONS

ENERGY STORAGE

ELECTROLYTES

POTENTIAL MARKETS FOR STRUCTURAL CERAMICS
LONG-TERM
(BEYOND YEAR 2000)

MORE (IN QUANTITY AND QUALITY) OF INTERMEDIATE-TERM PRODUCTS

HEAT ENGINE APPLICATIONS

TURBINE ENGINE ROTATING PARTS

- ROTORS
- REGENERATORS
- MILITARY AIRCRAFT

STIRLING ENGINE PARTS

WANKEL ENGINE PARTS

AIRCRAFT APU

SOLAR CONCENTRATOR TARGETS

MHD COMPONENTS

FUSION REACTOR COMPONENTS

FIRST WALL BLANKET

CERAMICS AND STRATEGIC MATERIALS

<u>MATERIAL</u>	<u>IMPORTS</u>	<u>STOCKPILED</u>	<u>POTENTIAL CERAMIC APPLICATIONS</u>
BERYLLIUM	N/A	YES	TILES, CASTINGS, FIBER-REINFORCED PARTS
COBALT	100%	YES	HEAT ENGINE PARTS, HEAT RECOVERY SYSTEM
CHROMIUM	90-100%	YES	HEAT ENGINES/EXCHANGERS, CHEMICAL WARE
COLUMBIUM	100%	YES	HIGH TEMPERATURE PARTS
MANGANESE	98%	YES	HEAT ENGINES
NICKEL	70-80%	YES	HEAT ENGINES/EXCHANGERS, CHEMICAL WARE
PLATINIUM	90%	YES	CHEMICAL WARE
TANTALUM	98%	YES	WEAR PARTS, HIGH TEMPERATURE PARTS
TITANIUM	N/A	YES	WEAR PARTS, CUTTING TOOLS, ABRASIVES, HEAT USES
TUNGSTEN	50-60%	YES	WEAR PARTS, CUTTING TOOLS, ABRASIVES

MACROECONOMIC EFFECTS ON CERAMICS IN HEAT ENGINES

ASSUMPTIONS

- 20% CERAMIC PENETRATION OF HEAT ENGINE MARKET FOR SELECTED COMPONENTS
 - CERAMIC COMPONENTS IN DIESEL TRUCKS IN 1985
 - CERAMIC COMPONENTS IN DIESEL CARS IN 1990
 - CERAMIC COMPONENTS IN STATIONARY TURBINE IN 1990
 - CERAMIC COMPONENTS IN TURBOCHARGERS IN 1985
 - U.S. HAS HEAT ENGINE STRUCTURAL CERAMICS FIRST
 - VEHICLE FUEL EFFICIENCY IMPROVED BY 30%.
 - STATIONARY ENGINE FUEL EFFICIENCY IMPROVED BY 35%.
-

	<u>CHANGE IN MACRO INDICATORS</u>		
	<u>1995</u>	<u>2000</u>	<u>2005</u>
GROSS NATIONAL PRODUCT	+0.3%	+0.5%	+0.3%
EMPLOYMENT	+0.1%	+0.2%	+0.2%
FUEL SAVINGS (QUADS)	<0.05	0.1	1.2
ENERGY IMPORTS SAVINGS (NOM \$BIL)	<1.0	2.5	37.4
IMPORTS SAVINGS (NOM \$BIL)	11.9	32.8	55.8

PRELIMINARY ANALYSIS - SUBJECT TO REVISION

DATA REQUIRED FOR MARKET ANALYSIS

1. DELINEATION OF END USE APPLICATIONS.
 - MATCH THE DEMAND AND SUPPLY CHARACTERISTICS
 - SEGMENT BY OBJECTIVES (MARKET, REGION, ETC.)
2. ESTIMATION OF TOTAL MARKET DEMAND FOR EACH APPLICATION
 - ALL FEASIBLE APPLICATIONS COMMERCIALY VIABLE
 - CURRENT AND FORECAST
3. ESTIMATIONS OF ECONOMICALLY ATTRACTIVE MARKET NICHE
 - MATERIAL COMPOSITION AND COSTS
 - HIGH VOLUME FABRICATION TECHNIQUES AND COSTS (INCLUDING QC)
 - CONSUMER COST FOR CERAMIC AND COMPETING MATERIALS
 - CAPITAL, OPERATING, AND LIFE CYCLE
4. ESTIMATION OF RATE OF MARKET PENETRATION
 - ESTIMATE PENETRATION WITH GOMPERTZ' OR OTHER S-CURVE
 - MODIFY CURVE APPROPRIATELY FOR NEW TECHNOLOGY

CIVILIAN MARKET ANALYSIS FOR STRUCTURAL CERAMICS

ABSTRACT

The following visual aids review the recent total civil engine market, advantages of newer ceramic materials and recent advances in ceramic fabrication. A scenario suggests that ceramics will be proven successful by 1985, proven cost effective by 1990 and proven reliable by 1992. Adiabatic diesels and gas turbines will be developed in parallel with about equal fuel economy, however, turbines will be proven environmentally superior in the 1990's. Gasoline engines will be shown to be incapable of adiabatic operation and will be non-competitive. An opportunity to develop ceramics is needed in the near term, perhaps ceramic turbochargers will provide that path.

Dr. John Mason, Vice President Engineering
The Garrett Corporation
*Mr. Karsten Styhr, Supervisor, Ceramics
AiResearch Casting Company

*Presentor - (213) 512-5963



HEAT ENGINES BY TYPE

CIVIL ONLY

	POWER (HP)
DIESELS	
HEAVY (SHIPS, LOCOMOTIVE)	>2,000
MEDIUM	750-2,000
LIGHT (TRUCKS, OFF-HIGHWAY)	125-750
PASSENGER CAR	<125
GASOLINE ENGINES	
PASSENGER CAR	<300
AIRCRAFT	<500
GAS TURBINES	
LARGE INDUSTRIAL*	>10,000
SMALL INDUSTRIAL	<10,000
LARGE AIRCRAFT	>8,000**
SMALL AIRCRAFT	<8,000
VEHICULAR: TRUCK, ETC.	200-1,000
VEHICULAR: PASSENGER CAR	<200
SOLAR	≈100

*INCLUDES AIRCRAFT DERIVATIVES

**8,000 HP OR 8,000 LB THRUST, AS APPLICABLE



STRENGTH VS TEMPERATURE

METALS AND CERAMICS

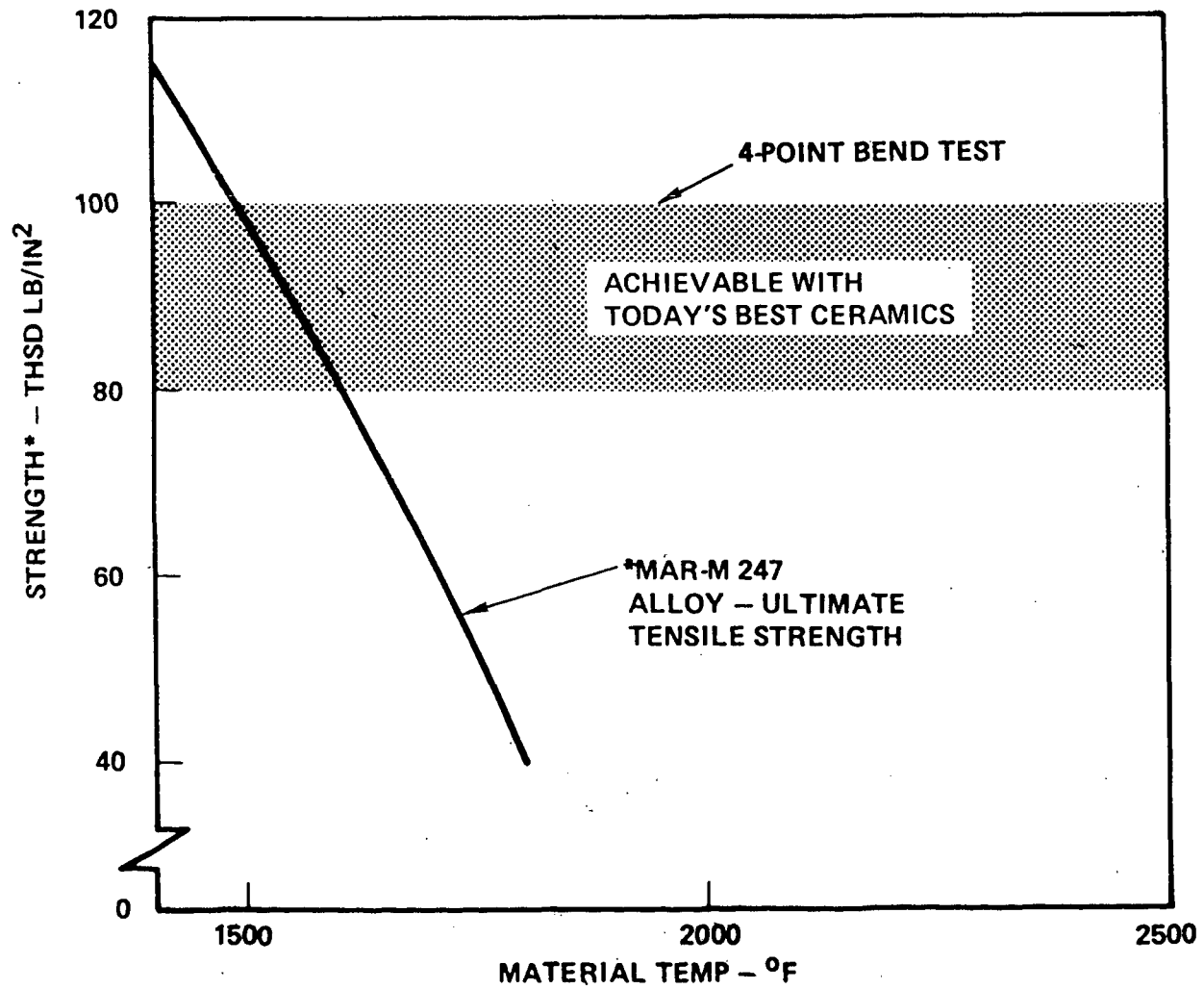



BEST THERMAL EFFICIENCY

(VEHICULAR GAS TURBINES)

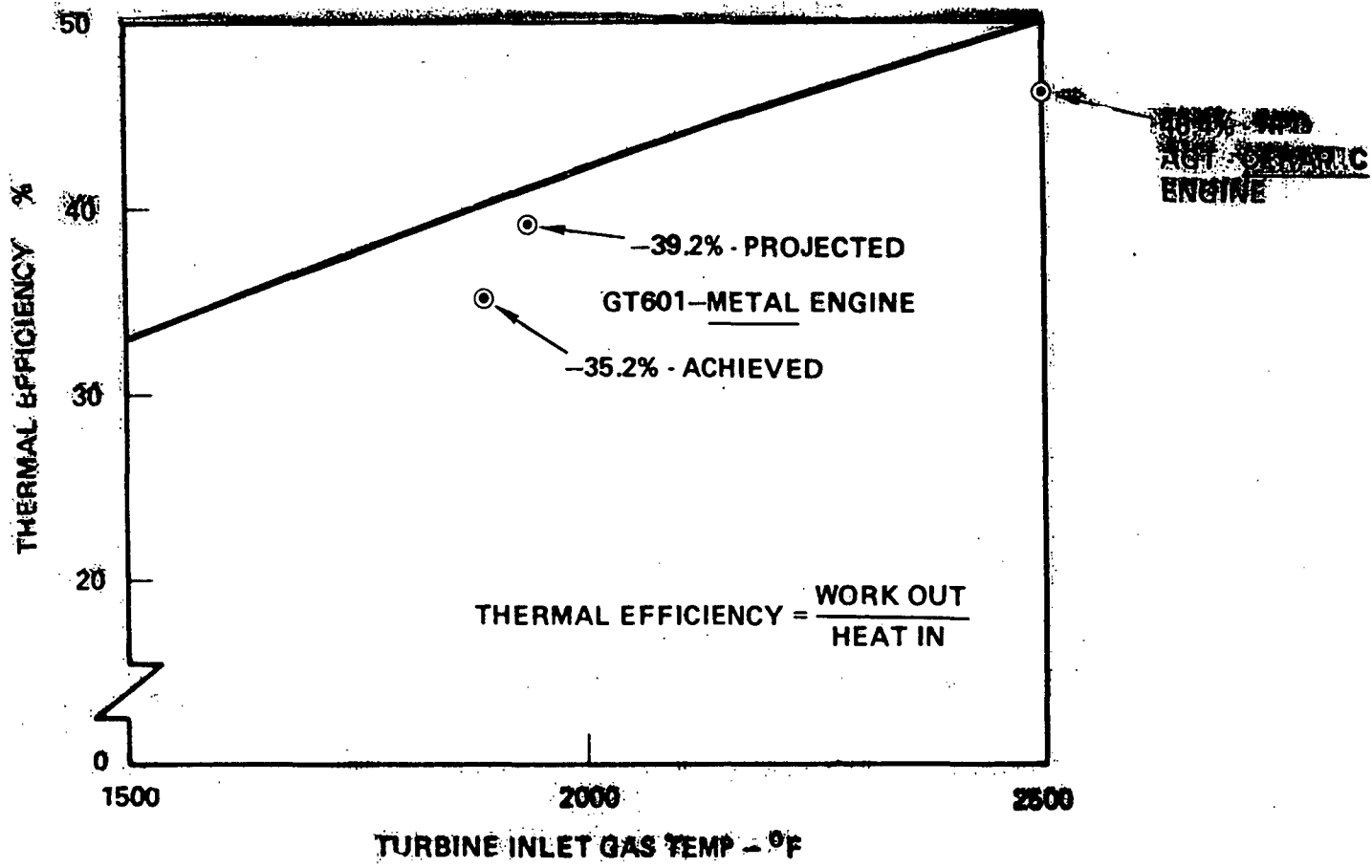

238



AGT-101 COMPONENT PROGRESS—1982

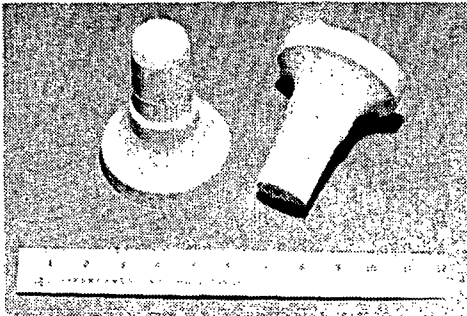

- EXCELLENT SURFACE FINISH
- HIGH DENSITY ($\approx 3.2 \text{ g/cm}^3$)
- MINIMUM TIME LAPSED FROM PATTERN AVAILABILITY TO CASTING DELIVERY

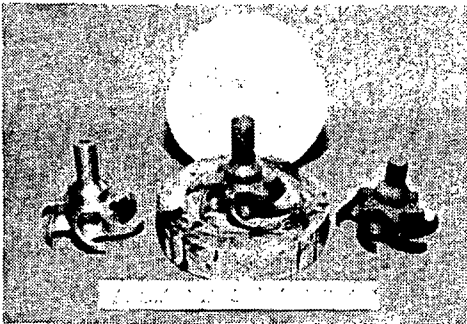

- FULLY NITRIDED EVEN IN THICKEST HUB AREA
- VERY NEAR NET SHAPE CASTING
- FAST TURNAROUND FROM PATTERN AVAILABILITY TO CASTING DELIVERY

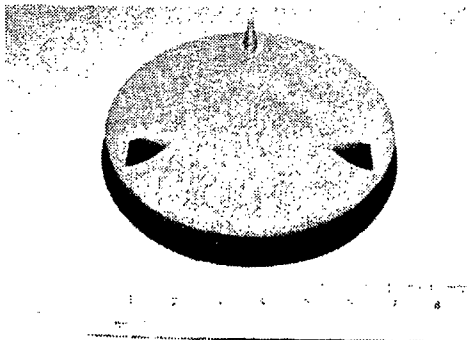

- FACE SHOWN IS CAST NET SHAPE
- EXCELLENT SURFACE FINISH
- HIGH YIELD COMPONENT



AGT-101 COMPONENT PROGRESS—1982

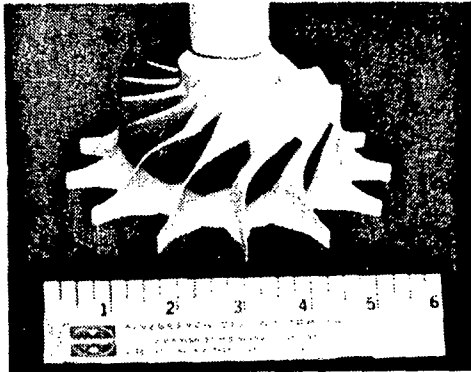

- IMPROVED CASTING TECHNIQUES
- GREATER CASTING UNIFORMITY
- EXCELLENT BLADE DETAIL
- HIGH DENSITY $\approx 3.2 \text{ g/cm}^3$

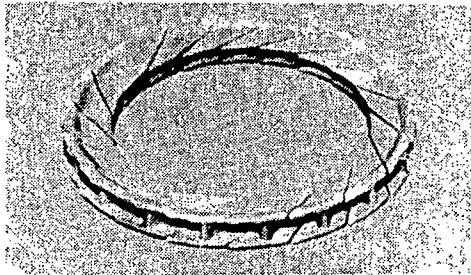

- IMPROVED BINDER SYSTEM
- GREATER YIELD
- INJECTED TO CLOSER TOLERANCE FOR MINIMUM FINAL GRINDING

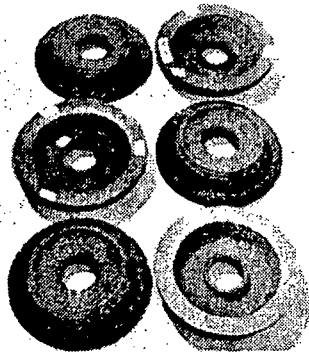

- IMPROVED SURFACE FINISH
- IMPROVED MOLD RELEASE
- IMPROVED MACHINING TECHNIQUES LEADING TO GREATER WEIGHT GAINS



ACC SLIP CAST SNN502 ROTOR

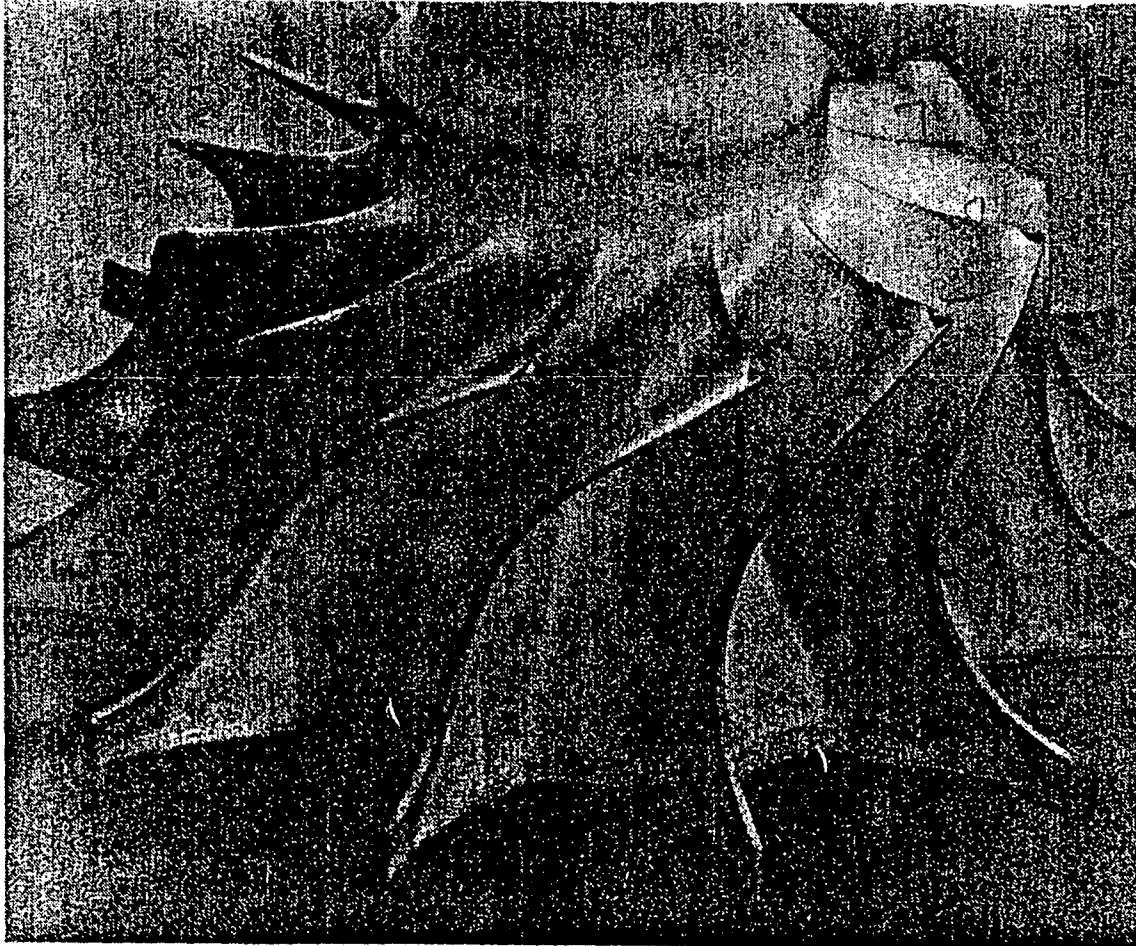

SPIN TESTED TO 103,000 RPM



T02 TURBOCHARGER WHEELS

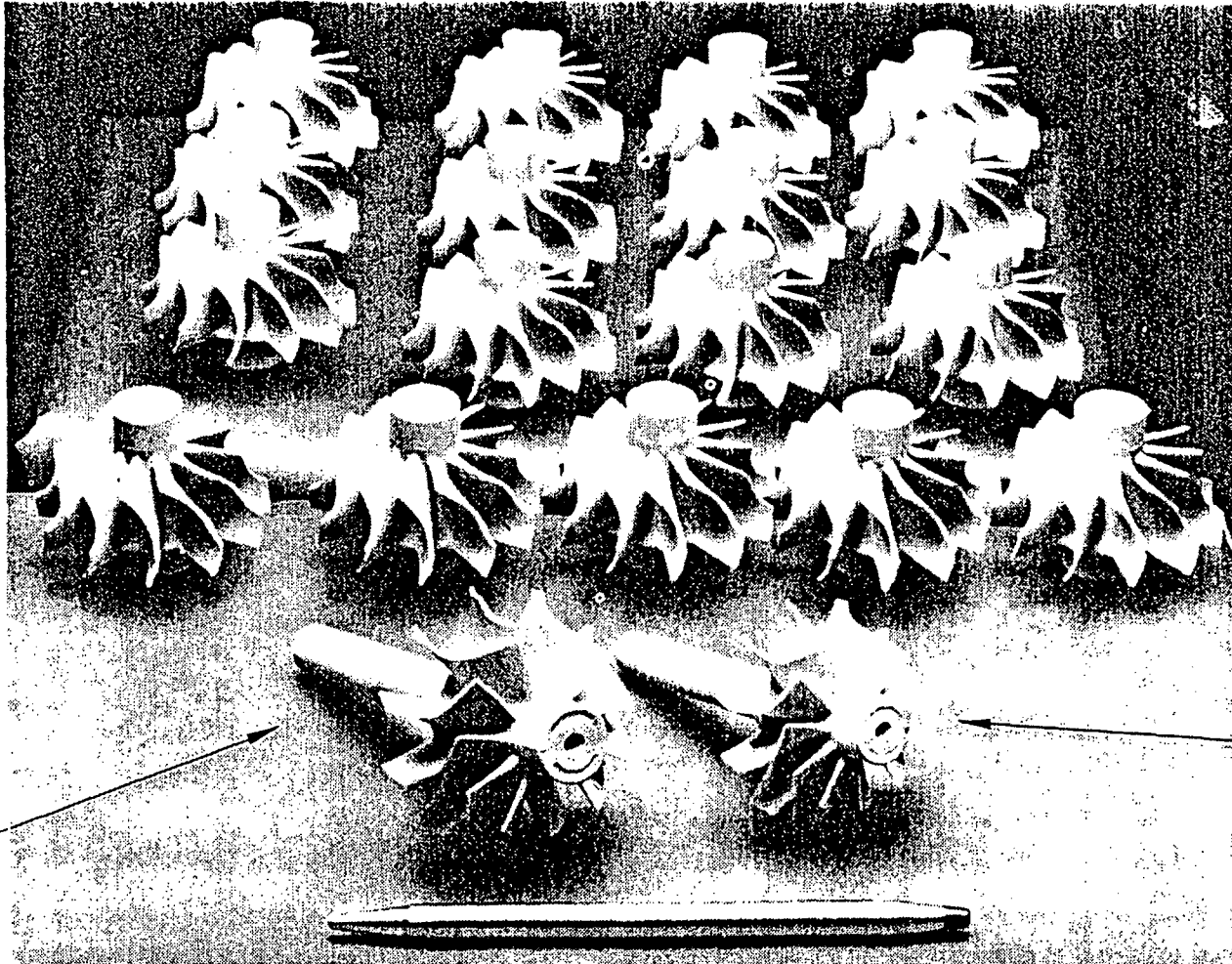

AS
MOLDED

SINTERED
SILICON
NITRIDE

FABRICATED BY AIRESEARCH CASTING CO. FOR GAPCO

242

SPA 7352-2



ENGINE SHIPMENTS—WORLDWIDE—YEAR 1981

CIVIL ONLY

	POWER (HP)	NUMBER
DIESELS		
HEAVY (SHIPS, LOCOMOTIVE)	>2,000	10,000
MEDIUM	750-2,000	600,000
LIGHT (TRUCKS, OFF-HIGHWAY)	125-750	2,000,000
PASSENGER CAR	<125	4,700,000
GASOLINE ENGINES		
PASSENGER CAR	<300	30,000,000
AIRCRAFT	<500	15,000
GAS TURBINES		
LARGE INDUSTRIAL*	>10,000	200
SMALL INDUSTRIAL	<10,000	300
LARGE AIRCRAFT	>8,000**	1500
SMALL AIRCRAFT	<8,000	3000
VEHICULAR: TRUCK, ETC.	200-1,000	0
VEHICULAR: PASSENGER CAR	<200	0
SOLAR	≈100	0

*INCLUDES AIRCRAFT DERIVATIVES

**8,000 HP OR 8,000 LB THRUST, AS APPLICABLE

PANEL DISCUSSION ON DOMESTIC CERAMIC PRODUCERS AND ENGINE MANUFACTURERS

Moderator: Robert B. Schulz (DOE)

Panelists: Anthony G. Evans (Lawrence Berkeley Laboratory)
Roy Kamo (Cummins Engine Co.)
John G. Lanning (Corning Glass Works)
David C. Larsen (Illinois Institute of Technology
Research Institute)
Maurice L. Torti (Norton Co.)
Thomas J. Whalen (Ford Motor Co.)

This Panel was concerned with issues that relate to the grid of potential interactions and resource utilization between

- (1) government funded R&D with private sector,
- (2) basic research programs with applied research programs,
- (3) ceramic scientists and engineers with mechanical engineers and designers,
- (4) DOE Laboratories, universities, and private industry, each with the other two,
- (5) domestic ceramic producers with domestic engine manufacturers.

This Panel emphasized possibilities for collaborative research, temporary personnel exchanges, sharing of unique or special capabilities, and information feed-back between groups, professions, and organizations.

Special concerns were

- o Coordination of efforts by engine designers and materials scientists. What can be done to promote a focus on enduring problems vs. temporary problems that can be resolved by design modification? Identification of what structural designers of engines view as long range research problems that will not be solved by engineering or design modification.
- o Identification of the fundamental needs relevant to obtaining an improved understanding of the intrinsic flaw populations in dense structural ceramics and how these flaw populations change with time in the combined environment of stress (static and dynamic), high temperatures, and various gaseous engine atmospheres. The relationship between sub-critical crack growth and environmental degradation for structural ceramics.
- o Does the Weibull representation and the present concept of sub-critical crack growth provide an adequate description of the mechanical behavior of structural ceramics? If not, what approach is recommended to develop and demonstrate more accurate representation of these materials?
- o Identification of the major needs for new or improved measurement techniques for accurately measuring the critical properties of structural ceramics for use in heat engines and high temperature heat exchangers.

- o Are the various engine programs overly monolithic? If the optimal design for a particular heat engine application were a hybrid consisting of some combination of coating(s) and different bulk structural ceramics, would it be possible to build and evaluate such a hybrid design? Identification of viable alternatives for evaluating optimal designs and engines.
- o How is it possible to more accurately measure the magnitude and character of residual stresses? Can the origin of residual stresses be related to the ceramic or engine fabrication procedures? Is there any realistic basis for believing that residual stresses can be minimized, or even eliminated, by the correct choice of manufacturing parameters?
- o Identification of the most attractive approaches to improved NDE for structural ceramics. Is there adequate interaction with instrument engineers and other relevant professions to optimize the rate of progress in NDE? Are small angle scattering techniques worth pursuing to follow the growth (or annihilation) of cavities (porosity) in structural ceramics?
- o Identification of the most promising long-term approaches to the problem of joining of structural ceramics.
- o Should there be concern for the behavior of transformation toughened ceramics such as ZrO_2 and HfO_2 under dynamic or repeated stress cycles? Are the conditions for reversibility of such transformation toughening reactions understood? Should there be concern for the stress-fatigue behavior for Si_3N_4 or SiC ?

PANEL DISCUSSION ON CONSENSUS CONCLUSIONS, UNRESOLVED CONCERNS
AND RECOMMENDATIONS FOR FOLLOW-UP ACTIONS

Moderator: Louis Ianniello (DOE)
Panelists: H. Kent Bowen (Massachusetts Institute of Technology)
Arthur F. McLean (Ford Motor Co.)
Maxine Savitz (DOE)
Victor J. Tennery (Oak Ridge National Laboratory)
Rao R. Tummala (International Business Machines Corp.)
David G. Wirth, Jr. (Coors Porcelain Co.)

This Panel was concerned with follow-up on technical issues, organization for future dialogue and coordination, the roles for government, universities, and private industry, and the interactions within this triumvirate.

One panelist spoke of the probability of Japanese dominance in high-technology ceramics, the Japanese thrust, and the basis of high technology ceramics in Japan as follows:

PROBABILITY OF JAPANESE DOMINANCE IN HIGH TECH CERAMICS

Engineers, Equipment, Capital
Engineers (including ceramists) top managers and on boards
Stated Goals: to be #1 or have high growth business
Commitment to manufacturing
Willing to start with small business
Synthesis of raw materials
Ceramics connected to electronics mentality

WHY JAPANESE THRUST?

Highly visible, national commitment, energy, resources, electronics, status of profession
Government Programs
MITI - structural ceramics, Min. of Educ. - Functional ceramics, Min. of Sci. and Tech. - grain boundaries and fine powders
Electronics and Electrical Industries
Si-carriers, capacitors, ferroelectrics, varistors, sensors
Cutting tools, wear resistance
Stagnation of chemicals industry

BASIS OF HIGH TECHNOLOGY CERAMICS IN JAPAN

Universities: B.S./M.S. students, narrowly trained, chemical engineering, synthesis, coupled to industry
National Laboratories: very basic research, loosely coupled to industry, outstanding facilities
Industrial Laboratories: highly structured, little research but lots of development; many empiricists with large budgets for equipment and facilities

The panelist that discussed the above outline referenced the September 1982 issue of the Bulletin of the American Ceramic Society (Vol. 61, no. 9, pp. 911-938) which contains twelve descriptive review articles on ceramics in Japan.

One panelist discussed the successful methods his company has used to interact with university ceramics research.

One panelist discussed the need for a long term commitment by both government and industry to structural ceramics research; the agreement appeared to be unanimous.

One panelist cited the subject of powder synthesis as a representative subject to illustrate the need for a multidisciplinary approach. The subject of ceramic powder synthesis would benefit from cross-fertilization(s) between inorganic chemists with colloid chemists. This panelist also spoke of government policy toward industry, and the desire to remove adversative attitudes, the necessity of appropriate tax incentives for industrial R&D, and the necessity to protect the proprietary aspects of industrial R&D.

One panelist spoke of the national need for a goal and leadership because of the presence of national laboratories, engine manufacturers, ceramic producers, and universities in this field. This panelist also commented that need/opportunity subjects to achieve technical success and a predictable reliability with structural ceramics include starting powder (preparation and characterization), forming, and forming processes, nitriding and sintering reactions, machinability, physical properties and behavior, mechanical strength properties and behavior, NDE, dimensional inspection, and screening or proof testing. Needs and opportunities in ceramic component design include component selection, design approach, attachments, and life prediction methodology.

One panelist spoke of the need for various program goals for government supported structural ceramics programs, and the role here for the Energy Materials Coordinating Committee. This panelist also discussed the need to achieve a balance between the protection of industrial proprietary interests and the simultaneous fulfillment of government requirements.

An audience participant spoke on behalf of the desirable involvement of the ceramic educational community, and the need for stable, long-term government support of university research.

Another participant discussed research needs concerning the machining of brittle materials, understanding microstructural damage caused by machining, and powder stereology. The need to get other disciplines involved in ceramics was emphasized, including through the use of government supported multidisciplinary research centers.

In closing, it was stated that this meeting was but one step in the effort of the Department of Energy and its Energy Materials Coordinating Committee to facilitate a dialogue between diverse and heterogenous groups that have a common objective in the development of reliable structural ceramics and to increase interactions between government funded research with private industry. The assistance of industry was requested in continuing to let the Department of Energy and the Energy Materials Coordinating Committee know how it can continue to help. Copies of this report will be sent to all 244

meeting participants; their identification, addresses, and affiliations are contained in this report. Finally, it was agreed that the Energy Materials Coordinating Committee would continue this dialogue by conducting a follow-up contractors meeting that will be more technical than the present one, which might occur in the Autumn of 1984.

The Department of Energy and the Energy Materials Coordinating Committee are grateful to the attendees for their thoughtful comments and constructive participation in this Contractors Meeting.

DIRECTORY OF ATTENDEES

Attendees
EMaCC Meeting
September 29-30, 1982

Mufit Akinc
Associate Ceramic Engineer
Ames Laboratory
128 Metallurgy
Iowa State University
Ames, IA 50010
515-294-5900, FTS 865-5900

C. A. Allen
Manager, Conservation/Bitechnology Branch
Idaho National Engineering Laboratory
EG&G Idaho, Inc.
P.O. Box 1625
Idaho Falls, ID 83415
208-526-0250

Richard T. Alpaugh
Chief, Advanced Technology & Assessment Branch
Department of Energy
CE-131, FORSTL
Washington, DC 20585
202-252-8012

Larry Anderson
Principal Engineer
Westinghouse R&D Center
Pittsburgh, PA 15235
412-256-3554

Frank Armatia
Sr. Chemist
3M Company
St. Paul, MN 55144
612-733-8949

Richard M. Arons
Sr. Research Ceramist
Celanese Research Co.
86 Morris Ave.
Summit, NJ 07901
201-522-7214

Neil N. Ault
Technical Director
Norton Company
1 New Bond Street
Worcester, MA 01606
617-853-1000, ext 2365

John M. Bailey
Research Consultant
Caterpillar Tractor Co.
100 NE Adams Street
Peoria, IL 61629
309-578-8197

Ron Baney
Associate Research Scientist
Dow Corning
3901 S. Saginaw Rd.
Building 5105, Mail #540
Midland, MI 48640
517-496-4329

H. Dean Batha
Technical Assistant to the President
Materials International
33 Hayden Ave., Suite 310N
Lexington, MA 02173
617-861-7920

Ronald L. Beatty
Manager, Ceramic Products Department
ARCO Metals, SILAG Operation
Rt. 6, Box A
Greer, SC 29651
803-877-0123

Harold N. Barr
Manager, R&D
Hittman Corporation
9190 Red Branch Road
Columbia, MD 21045
301-730-7800

Morris Berg
Adjunct Professor
University of Illinois
105 S. Goodwin Ave.
Urbana, IL 61801
217-333-1770

Clifton G. Bergeron
Professor & Head of Ceramic Engineering Dept.
University of Illinois
105 S. Goodwin Ave.
Urbana, IL 61801

Michael Besso
Manager, Exploratory & Diversification
Celanese Research Co.
86 Morris Ave.
Summit, NJ 07901
201-522-7998

John R. H. Black
Senior Research Associate
Charles River Associates, Inc.
200 Clarendon Street
Boston, MA 02116
617-266-0500

Brenda Bodian
Business Analysis Specialist
Martin Marietta Laboratories
1450 S. Rolling Road
Baltimore, MD 21227
301-247-0700, ext 348

H. Kent Bowen
Ford Professor of Engineering
Massachusetts Institute of Technology
Room 12-009
Cambridge, MA 02139
617-253-6892

R. A. Bradley
Manager, Fossil Energy Materials Program
Oak Ridge National Laboratory
P.O. Box X
Oak Ridge, TN 37830
615-574-6094

Raymond J. Bratton
Manager, Ceramic Science
Westinghouse Research & Development Center
1310 Beulah Road
Pittsburgh, PA 15235
412-256-7335

John J. Brennan
Sr. Research Scientist
United Technologies Research Center
East Hartford, CT 06108
203-727-7220

John Brogan
Office of Energy Systems Research
FORSTL
U.S. Department of Energy
Washington, DC 20585
202-252-1477

S. D. Brown
Professor, Ceramic Engineering
University of Illinois, Urbana-Champaign
105 S. Goodwin Ave., Room 203
Urbana, IL 61801
217-333-4766

Kalman E. Buchovecky
Manager, Chemicals & Ceramics Div.
Aluminum Company of America
Alcoa Technical Center
Alcoa Center, PA 15069
412-337-2301

Kent Buesking
Project Engineer
Materials Sciences Corporation
Gwynedd Plaza II, Bethlehem Pike
Spring House, PA 19477
215-542-8400

Larry Burkhart
Program Director - Materials Chemistry
Ames Laboratory
109 Metals Development
Iowa State University
Ames, IA 50011
515-294-8074, FTS 865-8074

Daniel Byrne
Mechanical Technology Inc.
968 Albany-Shaker Road
Latham, NY 12110
518-456-4142

Harry W. Carpenter
Member of the Technical Staff
Rocketdyne Division, Rockwell International
Mail Stop D539/HC92
6633 Canoga Ave.
Canoga Park, CA 91304
213-710-3828

Joseph A. Carpenter, Jr.
Manager of Materials, Project of DOE/ECUT Program
Oak Ridge National Laboratory
Bldg. 4508, Room 114
P.O. Box X
Oak Ridge, TN 37830
615-574-4571, FTS 624-4571

Larry K. Carpenter
Project Manager
US/DOE, Morgantown Energy Technology Center
P. O. Box 880
Morgantown, WV 26505
304-291-4724

James P. Carr
Project Manager
FE-24, GTN
U.S. Department of Energy
Washington, DC 20545
301-353-5985, FTS 233-5985

Jeff Carr
Marketing Manager-Ceramics Dept.
Kaman Sciences Corp.
4675 Northpark Drive
Colorado Springs, CO 80907
303-599-1551

A. Carter
Attorney
GM
11339 Empire Lane
Rockville, MD 20852
301-984-1355

Calvin H. Carter, Jr.
Research Assistant, Materials Engineering Dept.
North Carolina State University
232 Riddick Laboratory
Raleigh, NC 27650
919-737-3272

R. J. Charles
Ceramics Branch Manager
General Electric Co.
P.O. Box 8
Schenectady, NY 12309
518-385-8605

Andy Chen
Director
Technical Resources, Inc.
10215 Fernwood Rd., Suite 408
Bethesda, MD 20817
301-493-5300

Albert A. Chesnes
Director
Technical Development & Analysis Division
U.S. Department of Energy
Washington, DC 20585
202-252-8053

Ken Chidester
Engr. Mgr., Ceramics Dept.
Kaman Sciences Corp.
4675 Northpark Drive
Colorado Springs, CO 80907
303-599-1559

Leo Christodoulou
Scientist
Martin Marietta Laboratories
1450 S. Rolling Road
Baltimore, MD 21227
301-247-0700, ext 386

Tze-jeer Chuang
Physicist
National Bureau of Standards
Washington, DC 20234
301-921-2890

Bill Cleary
Associate Division Director
ORI, Inc.
1400 Spring Street
Silver Spring, MD 20910
301-588-6180

Joseph Cleveland
Silicon Nitride Section Head
Chem. & Met. Div.
GTE Corporation
Towanda, PA 18848
717-265-2121, ext 683

David Clough
Research Chemist
Zirconium Oxide Manufacturer
Magnesium Elektron, Inc.
Star Route A, Box 202-1
Flemington, NJ 08822
201-782-5800

R. L. Coble
Professor of Ceramics
Massachusetts Institute of Technology
13-4062
Cambridge, MA 02139
617-253-3318

William G. Collins, Jr.
Cdr., USN
Office of Military Application
U.S. Department of Energy
DP-225, GTN
Washington, DC 20545
301-353-5494, FTS 233-5494

George A. Costakis
Staff Project Engineer
Adv. Product & Manufacturing Engrg. Staff
General Motors Corporation
APE/SOW, G. M. Technical Center
Warren, MI 48090-9010
313-575-1130

S. D. Dahlgren
Manager, Metallurgy Research
Pacific Northwest Laboratory
P. O. Box 999
Richland, WA 99352
509-376-0120

S. J. Dapkunas
Program Manager
U.S. DOE/FE
MS C-156, GTN
Washington, DC 20545
301-353-2784

J. B. Darby, Jr.
Program Staff
Division of Materials Sciences
ER-132, GTN
U.S. Department of Energy
Washington, DC 20545
301-353-3426, FTS 233-3426

Robert F. Davis
Professor, Materials Engineering Department
North Carolina State University
232 Riddick Laboratory
Raleigh, NC 27650
919-737-3272

Arthur M. Diness
Associate Director, Engineering Sciences Directorate
Office of Naval Research
800 N. Quincy Street
Arlington, VA 22217
202-696-4407

John D. Drew
Senior Engineer
Airco, Inc.
Central Research Laboratories
Murray Hill, NJ 07974
201-464-8100

Winston Duckworth
Battelle Institute
505 King Ave.
Columbus, OH 43201
614-424-7535

Thomas J. Dwyer
Manager, Technology Development
Corning Glass Works
Sullivan Park, FR-25
Corning, NY 14831
607-974-3801

Robert C. Ehrenstrom
Washington Representative
Detroit Diesel Allison
Division of General Motors Corp.
1800 North Kent Street, Suite 1120
Arlington, VA 22209
202-775-5058

Wm. A. Ellingson
Scientist
Argonne National Laboratory
9700 South Cass Ave.
Argonne, IL 60439
312-972-5068

Anthony G. Evans
Professor/Principal Investigator
Lawrence Berkeley Laboratory
University of California
264 Hearst Mining Bldg.
Berkeley, CA 94720
415-642-7347

Robert C. Evans
Assistant Manager, Vehicular Gas Turbine
and Diesel Project Office
NASA-Lewis Research Center
21000 Brookpark Rd.
Cleveland, OH 44135
216-433-4000, ext 6770

John Fairbanks
Program Manager
FE-26, GTN
U.S. Department of Energy
Washington, DC 20545
301-353-2822, FTS 233-2822

John J. Fedorchak
Product Manager - Ceramics
GTE Products Corporation
Hawes Street
Towanda, PA 18848
717-265-2121

Richard Fields
Metallurgist
National Bureau of Standards
Washington, DC 20234
301-921-2980

E. A. Fisher
Principal Staff Engineer
Ford Motor Company
Scientific Laboratory, Room E-3172
Box 2053
Dearborn, MI 48121
313-337-5485

Peter B. Fleming
Laboratory Manager
3M
3M Center, Building 207-1W-11
St. Paul, MN 55144
612-733-0641

Thomas L. Francis
Section Head
Alcoa
Alcoa Center, PA 15069
412-337-2445

Jay Frankel
Associate Division Director
ORI, Inc.
1400 Spring Street
Silver Spring, MD 20910
301-588-6180

B. C. Frazer
Division of Materials Sciences
ER-132, GTN
U.S. Department of Energy
Washington, DC 20545
301-353-3426, FTS 233-3426

Edwin R. Fuller, Jr.
Physicist/Group Leader
National Bureau of Standards
Bldg. 223, Room A113
Washington, DC 20234
301-921-2934

James J. Gangler
Consultant
6730 Kenwood Forest Lane
Chevy Chase, MD 20815
301-652-6730

George J. Gardopee
Sr. Materials Engineer
Perkin Elmer Corporation
100 Wooster Heights Road
Danbury, CT 06810
203-797-6171

Jeffrey M. Gonzalez
Department Head - Ceramics
GTE Products Corporation
Hawes Street
Towanda, PA 18848
717-265-2121

Donald R. Gorsuch
Director, New Business Development
Norton Company
1 New Bond St.
Worcester, MA 01606
617-853-1000

Robert J. Gottschall
Division of Materials Sciences
ER-131, GTN
U.S. Department of Energy
Washington, DC 20545
301-353-3428, FTS 233-3428

Jeffrey H. Grammer
Business Development
GTE Products
Hawes Street
Towanda, PA 18848
717-265-2121

Edgar W. Gregory, II
Program Manager
Office of Vehicle & Engine R&D, CE-131.2, FORSTL
U.S. Department of Energy
Washington, DC 20585
202-252-8064

Janie J. Guerra
Marketing Manager
Advanced Refractory Technologies, Inc.
699 Hertel Avenue
Buffalo, NY 14207
716-875-4091

T. D. Gulden
Mgr., Ceramics and Chemistry
General Atomic Cor.
P.O. Box 81608
San Diego, CA 92138
714-455-2893

Patrick E. Hart
Manager, Ceramics Development Section
Battelle-Northwest
P.O. Box 999
Richland, WA 99352
509-375-2906

John S. Haggerty
Senior Research Scientist
Massachusetts Institute of Technology
12-011, 77 Massachusetts Avenue
Cambridge, MA 02139
617-253-2129

Robert A. Harmon
Consultant
25 Schalren Drive
Latham, NY 12110
518-785-8651

D. P.H. Hasselman
Professor
Department of Materials, Engineering
Virginia Polytechnic Institute
Blacksburg, VA 24061
703-961-5402

Peter W. Heitman
Section Chief-Ceramic Materials
Detroit Diesel Allison
P.O. Box 894
Indianapolis, IN 46206
317-242-3803

Ezra Heitowit
Deputy Staff Director
Subcommittee on Energy Development & Applications
Committee on Science & Technology
U.S. House of Representatives
Washington, DC 20515
202-225-4494

Harold E. Helms
Chief Project Engineer AGT/CATE, T15
Detroit Diesel Allison Division, GMC
P.O. Box 894
Indianapolis, IN 46206
317-242-5355

Thomas L. Henson
Director of Research and Engineering
GTE Products Corporation
Hawes Street
Towanda, PA 18848
717-265-2121

Henry T. Hidler
Director of Engineering
Precision Materials Group
GTE Corporation
100 Endicott St.
Danvers, MA 01923
617-777-1900, ext 3373/2377

Le Khac Hien
Research Engineering
DHR Inc.
1055 Thomas Jefferson, NW
Washington, DC 20007
202-342-4000

Anthony Highfield
Sherwood Refractories, Inc.
Octavia
Cleveland, OH 44112
216-383-4084

Anthony Highfield
Technical Manager
TRW Inc.
Euclid Ave.
Cleveland, OH
216-383-4000

John M. Hobday
Gen. Engineer
DOE/METC
Box 880
Morgantown, WV 26505
304-291-4347, FTS 923-4347

Eugene E. Hoffman
DOE/ORO Mgr. National Materials Programs
U.S. Department of Energy
Oak Ridge Operations Office
P.O. Box E
Oak Ridge, TN 37320
615-576-0735, FTS 626-0735

Clifford Holdridge
Strategic Marketing Manager
GTE Products Corporation
Hawes Street
Towanda, PA 18848
717-265-2121

Betsy Houston
Executive Vice President
Hamilton & Associates, Inc.
1901 L Street, NW
Washington, DC 20036
202-296-2606

Louis Ianniello
Director, Division of Materials Sciences
ER-13, GTN
U.S. Department of Energy
Washington, DC 20545
301-353-3427, FTS 233-3427

Virgil Irick
Mgr., Product Development
3M
207-15C 3M Center
St. Paul, MN 55144
612-736-9684

David S. Jackson
Senior Research Associate
CIA-Office of Global Issues
Washington, DC 20505
703-351-7343

Loren A. Jacobson
Program Manager
DARPA/MSD
1400 Wilson Blvd.
Arlington, VA 22209
202-694-1346

Karl Jakus
Professor
University of Massachusetts
Amherst, MA 01003
413-545-2424

Greg Jarrabet
Brunswik Corp.
2000 Brunswik Lane
Deland, FL 32720

Joseph A. Jaumotte
Marketing Mgr. - Industrial Ceramics
Harbison-Walker Refractories
Div. Dresser Industries, Inc.
2 Gateway Center
Pittsburgh, PA 15222
412-562-6459

Larry R. Johnson
Transportation Economist
Argonne National Laboratory
Bldg. 362, Room G-212
Argonne, IL 60439
312-972-5631

Sylvia M. Johnson
Materials Scientist
SRI International
333 Ravenswood Avenue
Menlo Park, CA 94025
415-859-4277

Steve Kalos
Senior Research Associate
Charles River Associates, Inc.
200 Clarendon Street
Boston, MA 02116
617-266-0500

Roy Kamo
Exec. Director-Research
Cummins Engine Co.
Columbia, IN 47201
812-379-5591

Robert N. Katz
Chief, Ceramics Research Division
Army Materials & Mechanics Research Center
Arsenal Street
Watertown, MA 02172
617-923-5415

Ronald Keller
TRW Corporation
23555 Euclid Ave.
Cleveland, OH 44117
216-383-3174

Ron L. Kelley
Manager, Business Development
Dow Corning Corporation
1800 M Street, NW
Washington, DC 20036
202-785-0585

Dr. Kelsey
Ceramics GL
Idaho National Engineering Laboratory
P.O. Box 1625
Idaho Falls, ID 83401
208-526-8328, FTS 583-8328

Hien Le Khac
Project Engineer
DHR, Inc. (Suite 414)
1055 Thomas Jefferson Street, NW
Washington, DC 20007
202-342-5400

David Kingery
Professor
Massachusetts Institute of Technology
Room 13-4090
Cambridge, MA 02139
617-253-3319

Robert S. Kirby
Pgm. Manager, Weapons R&D
Los Alamos National Laboratory
NSP/WTO, MS-F619
P.O. Box 1663
Los Alamos, NM 87545
505-667-3977, FTS 843-3977

Henry P. Kirchner
Ceramic Finishing Co.
P.O. Box 498
St. College, PA 16801
814-238-4270

Douglas A. Koop
Director, Project Development
Ebasco Services Inc.
2 World Trade Center
New York, NY 10048
212-839-4273

Saunders B. Kramer
Manager, AGT Program
U.S. DOE/OVERD/CE
GB-096, FORSTL
Washington, DC 20588
202-252-8012

Dave Kupperman
Physicist
Argonne National Laboratory
Bldg. 212
9700 S. Cass Ave.
Argonne, IL 60439
312-972-5108

Richard L. Landingham
Section Leader/Ceramics, Corrosion & Thermochemistry
Lawrence Livermore National Laboratory
P.O. Box 808, L-369
Livermore, CA 94550
415-422-8022

Frederick F. Lange
Principal Scientist
Rockwell International Science Center
P.O. Box 1085
Thousand Oaks, CA 91360
805-498-4545

John G. Lanning
Manager, Advanced Engine Components Dept.
Corning Glass Works
Sullivan Park, DV-01-1
Corning, NY 14831
607-974-3923

David C. Larsen
Senior Research Engineer
IIT Research Institute
10 West 35th St.
Chicago, IL 60616
312-567-4437

D. William Lee
Vice President, Materials
Arthur D. Little, Inc.
15 Acorn Park
Cambridge, MA 01240
617-864-5770

Edward Lenoë
Chief, MMD
AMMRL
Arsenal Street
Watertown, MA 02171
617-923-5427

Terry M. Levinson
Special Assistant to the Director
Office of Energy Systems Research
U.S. Department of Energy
FORSTL
Washington, DC 20585
202-252-1477

Bohdan Lisowsky
Eaton Corp.
26201 Northwestern Highway
Southfield, MI 48037
313-354-9020

Arnold P. Litman
OVEA/DOE
NE-34
Washington, DC 20545
301-353-5777, FTS 233-353-5777

Ronald E. Loehman
Member of Technical Staff
Sandia National Laboratories
P.O. Box 5800, Division 1845
Albuquerque, NM 87185
505-844-0949

E. L. Long, Jr.
Staff Member
Oak Ridge National Laboratory
P.O. Box X, Bldg. 4508
Oak Ridge, TN 37830
615-574-5172

T. L. Loucks
V.P. Corporate Technology
Norton Company
1 New Bond Street
Worcester, MA 01606
617-853-1000, ext 3624

Pat A. Madden
Marketing
SKF Industries, Inc.
1100 First Avenue
King of Prussia, PA 19406
215-265-1900

N. J. Magnani
Department Manager
Sandia National Laboratories
Department 1840
Albuquerque, NM 87185
505-844-3475

Paul C. Maxwell
Science Consultant
Comm. on Science & Technology
U.S. Congress
Washington, DC 20515
202-225-8115

George H. Mayo
Chief Engineer, Advanced Development, T21
Detroit Diesel Allison Div.
GMC
P.O. Box 894
Indianapolis, IN 46206
317-242-4757

David J. McFarlin
Sr. Project Engineer
United Technologies Research Center
East Hartford, CT 06108
203-727-7432

Jim McLaughlin
Materials Engineer
Teledyne CAE
1330 Laskey Rd.
Toledo, OH 43612
419-470-3186

A. F. McLean
Manager, Ceramics Research
Ford Motor Company
Dearborn, MI 48104
313-322-3859

Mel I. Mendelson
MS-32
Pratt & Whitney Aircraft
P.O. Box 2691
W. Palm Beach, FL 33402
305-840-3296

Gary L. Messing
Assistant Professor of Ceramic Science
Penn State University
119 Steidle Building
University Park, PA 16802
814-865-2262

Arthur G. Metcalfe
Associate Director, Research
Solar Turbines Incorporated
P.O. Box 80966
San Diego, CA 92138
714-238-5848

Paul Rex Miller
Manager, Conservation & Fossil Energy Systems
NASA
Washington, DC 20546
202-755-8475

Thomas J. Miller
Head, Ceramics Section
NASA-Lewis Research Center
21000 Brookpark Rd., M.S. 49-3
Cleveland, OH 44135
216-433-4000, ext 6153

Frank A. Modine
Group Leader, High Temperature Ceramics
Oak Ridge National Laboratory
P.O. Box X, Bldg. 3025
Oak Ridge, TN 37830
615-574-6287

Jack Moteff
Grad. Student
Carnegie Mellon
203 Morewood
Pittsburgh, PA 15213
412-578-2670

James I. Mueller
Professor of Ceramic Engineering
University of Washington
Ceramic Engineering, FB-10
University of Washington
Seattle, WA 98195
206-543-2613

John F. Mulloy
Contract Specialist
The Dow Chemical Company
Contract RD&E
566 Building
Midland, MI 48640
517-636-5168

Solomon Musikant
Program Manager, Adv. Matls.
General Electric Company
Adv. Energy Pgms. Dept.
P.O. Box 527
King of Prussia, PA 19406
215-962-5825

T. V. Narayanan
Research Associate
Foster Wheeler Dev. Corp.
12 Peach Tree Hill Road
Livingston, NJ 07039
201-533-2377

Robert G. Naum
Business Development Manager/Systems Energy
Carborundum Resistant Materials Company
Advance Materials Division
Box 832
Niagara Falls, NY 14302
716-278-2689

Ralph H. Nielsen
Dir., Chem. R&D
Teledyne Wah Chang Albany Corp.
P.O. Box 460
Albany, OR 97321
503-926-4211

Dale E. Niesz
Manager, Materials Department
Battelle Columbus Laboratories
505 King Ave.
Columbus, OH 43201
614-424-6577

Richard J. Palicka
General Manager
CERADYNE, INC.
3030-A South Red Hill Ave.
Santa Ana, CA 92705
714-549-0421

Charles R. Parent
Senior Scientist
Owens-Illinois, Inc.
One Seagate
Toledo, OH 43666
419-247-8906

Don Parkin
Division of Materials Sciences
ER-131, GTN
U.S. Department of Energy
Washington, DC 20545
301-353-3428, FTS 233-3428

James W. Patten
Director, Materials Engineering
Cummins Engine Company, Inc.
Box Number 3005
Mail Code 50183
Columbus, IN 47201
812-379-5514

John B. Patton
Project Manager
Department of Energy
550 Second St.
Idaho Falls, ID 83401
208-526-0708

D. A. Payne
Professor
University of Illinois
105 S. Goodwin Ave.
Urbana, IL 61801
217-333-2937

Daniel R. Petrak
Group Supervisor
Babcock & Wilcox
P.O. Box 239
Lynchburg, VA 24505
804-522-6177

John J. Petrovic
Materials Scientist
Los Alamos National Laboratory
Group MST-5, Mail Stop G730
Los Alamos, NM 87545
505-667-5452

William T. Petuskey
Assistant Professor
Dept. of Ceramic Engineering
University of Illinois
105 S. Goodwin Ave., 203 Ceramics Bldg.
Urbana, IL 61801
217-333-7207

Richard C. Phoenix
Vice President, Advanced Materials Division
Carborundum Resistant Materials Company
P.O. Box 156
Niagara Falls, NY 14302
716-278-2209

I. Pincus
Assistant to the President
IIT Research Institute
10 West 35th Street
Chicago, IL 60616
312-567-4007

Roger B. Poeppel
Group Leader
Argonne National Laboratory
9700 S. Cass Ave.
Argonne, IL 60439
312-972-5118

R. C. Pohanka
Research Engineer
U.S. Navy
Office of Naval Research
Arlington, VA 22717
696-4402

Tom Powers
Supervisor NDM&D
Lynchburg Research Center
P.O. Box 239
Lynchburg, VA 24505
804-525-5038

Karl M. Prewo
Principal Scientist - Composites and Nonmetallics
United Technologies Research Center
E. Hartford, CT 06108
203-727-7237

Peter Price
Director of Engineering
Industrial Materials Technology, Inc.
P.O. Box 565
Andover, MA 01810
617-470-1620

Bert Probst
Chief, Non-Metallic Materials Branch
NASA Lewis Research Center
21000 Brookpart Rd., MS 49-3
Cleveland, OH 44135
216-433-4000, ext 392, FTS 294-6392

C. L. Quackenbush
Technical Manager
GTE Labs
40 Sylvan Road
Waltham, MA 02254
617-890-8460, ext 2536

Rishi Raj
Professor
Cornell University
Bard Hall
Ithaca, NY 14853
607-256-4040

Stephen Rattien
President
DHR, Incorporated
1055 Thomas Jefferson St., NW
Washington, DC 20007
202-342-5400

Harry W. Rauch, Sr.
Ceramist
GE - Advanced Energy Programs Department
P.O. Box 8555
Philadelphia, PA 19101
215-962-2195

Wilfred J. Rebello
President
PAR Enterprises, Inc.
11928 Appling Valley Road
Fairfax, VA 22030
703-273-8274

Robert B. Reid
V.P. Engineering & Mfg.
Precision Materials Group
GTE Corporation
100 Endicott St.
Danvers, MA 01923
617-777-1900, ext 2468/2377

Paul Rempes
Sr. Research Engineer
Champion Spark Plug Co.
20000 Connor Ave.
Detroit, MI 48073
313-891-4040

Richard Rentz
Senior Engineer
Mueller Associates, Inc.
600 Maryland Ave., SW
Washington, DC 20024
202-484-9484

Jim Rhodes
Sr. Specialist, Adv. Materials
Williams International
P.O.Box 200
Walled Lake, MI 48088
313-624-5200, ext 1695

Roy W. Rice
Branch Head
Naval Research Laboratory, Code 6360
Washington, DC 20375
202-767-2131

Dave Richerson
Supervisor, Advanced Materials
Garrett Turbine Engine Co.
111 S. 34th St.
P.O. Box 5217
Phoenix, AZ 85010
602-267-3649

John E. Ritter, Jr.
Professor
University of Massachusetts
Mechanical Engr. Dept.
Amherst, MA 01007
419-545-0632

Wolfgang U. Roessler
Director, Energy Conservation Directorate
The Aerospace Corporation
P.O. Box 92957
El Segundo, CA 90009
213-648-5550

Alan R. Rosenfield
Senior Research Scientist
Battelle's Columbus Laboratories
505 King Ave.
Columbus, OH 43201
614-424-4353

Tom G. Roskos
Manager, Plastics Research Lab.
A. O. Smith Corporation
P.O. Box 584
Milwaukee, WI 53201
414-447-4277

Michael Rossetti
Staff Consultant
Arthur D. Little, Inc.
15 Acorn Park
Cambridge, MA 02140
617-864-5770

Robert Ruh
Air Force Wright Aeronautical Lab
Wright Patterson AFB, Ohio
513-255-4402

Robert J. Russell
General Manager, Technology & Business Development
Norton Company
1 New Bond Street
Worcester, MA 01606
617-853-1000

Maxine Savitz
Dept. Asst. Sec. for Construction
U.S. Department of Energy
FORSTL
Washington, DC 20585
202-252-9232

A. C. Schaffhauser
Manager, Conservation Technology Programs
Oak Ridge National Laboratory
P.O. Box X
Oak Ridge, TN 37830
615-574-4826, FTS 624-4826

John C. Schettino
Executive Scientist
ORI, Inc.
1400 Spring Street
Silver Spring, MD 20904
301-588-6180

Robert B. Schulz
Program Manager
DOE, Vehicle Engine R&D
CE-131.2, FORSTL
Washington, DC 20585
202-252-8064

Murray A. Schwartz
Senior Policy Analyst
Office of Science and Technology Policy
New Executive Office Building (5002)
Washington, DC 20500
202-395-5860

Richard Y. Scott
Senior Scientist
ORI, Inc.
1400 Spring St.
Silver Spring, MD 20910
301-588-6180

Peter T. B. Shaffer
Vice President
Advanced Refractory Technologies, Inc.
699 Hertel Avenue
Buffalo, NY 14207
716-875-4091

Jack D. Sibold
Development Engineer
Coors Porcelain Company
600 9th Street
Golden, CO 80401
303-277-4195

Richard Silberglitt
Principal
DHR, Inc. (Suite 414)
1055 Thomas Jefferson Street, NW
Washington, DC 20007
202-342-5400

S. R. Skaggs
Staff Member
Alternate Energy Programs
P.O. Box 1663, MS F-682
Los Alamos, NM 87545
505-667-3973, FTS 843-3973

Jan Skalny
Associate Director
Martin Marietta Laboratories
1450 S. Rolling Road
Baltimore, MD 21227
301-247-0700, ext 432

C. E. Skinner
Technology Mgr.
Dow Corning
3901 S. Saginaw Rd.
Building 5105, Mail #540
Midland, MI 48640
517-496-4843

J. Thomas Smith
Advocate Director PMTC
GTE Labs
40 Sylvan Road
Waltham, MA 02254
617-890-8460

Robert G. Smith
Advisory Analyst
PAR Enterprises, Inc.
11928 Appling Valley Road
Fairfax, VA 22030
703-273-8274

Jay R. Smyth
Senior Materials Engineer
Garrett Turbine Engine Co.
111 S. 34th St., MS/503-4Y
Phoenix, AZ 85010
602-267-4213

Richard M. Spriggs
Sr. Staff Scientist
National Materials Advisory Board
2101 Constitution Ave., NW
Washington, DC 20418
202-334-3489

M. Srinivasan
Carborundum
Niagara Falls, NY 14302
716-278-2570

Henry L. Stadler
Director, OVERD
U.S. Department of Energy
FORSTL
Washington, DC 20585
202-252-9118

Gordon L. Starr
Manager - Metallic/Ceramic Materials Development
Cummins Engine Company, Inc.
Box Number 3005, Mail Code 50183
Columbus, IN 47201
812-379-6978

Patrick M. Stephan
Research Scientist
Battelle's Columbus Laboratories
505 King Ave.
Columbus, OH 43201
614-424-4004

Donald K. Stevens
Deputy Associate Director
for Basic Energy Sciences
U.S. Department of Energy
ER-11, GTN
Washington, DC 20545
301-353-3081, FTS 233-3081

Peter A. Stranges
Manager
United Technologies Research Center
1825 Eye Street, NW
Washington, DC 20006
202-785-7421

Ed Straub
Marketing Representative
Martin Marietta Laboratories
1450 S. Rolling Road
Baltimore, MD 21227
301-247-0700, ext 312

Frederick G. Stroke
Consultant
Vesuvius Crucible Research Center
4604 Campbells Run Road
Pittsburgh, PA 15205
412-923-1141

Karsten Styhr
Supervisor, Ceramics Engineering
AiResearch Casting Company
19800 Van Ness Avenue
Torrance, CA 90509
213-512-5963

Masaki Suenaga
Division Head
Brookhaven National Laboratory
Upton, NY 11713
FTS 282-3518

V. J. Tennery
Director, High Temperature Materials Laboratory
Oak Ridge National Laboratory
P.O. Box X
Oak Ridge, TN 37830
615-574-5123

T. Y. Tien
Professor
Materials & Metallurgical Engineering
2146B Dow
University of Michigan
Ann Arbor, MI
313-764-9449

Nancy J. Tighe
National Bureau of Standards
A113, Bldg. 223
Washington, DC 20234
301-921-2901

Maurice L. Torti
Senior Scientist
Norton Company
1 New Bond Street
Worcester, MA 01606
617-853-1000, ext 2092

Ronald W. Trischuk
Mgr., Product R&D
Norton Company
8001 Daly Street
Niagara Falls, Ontario, Canada L2G 6S2
416-295-4311

R. R. Tummala
Manager, Substrate Mater. Tech.
IBM
East Fishkill, NY 12533
914-897-6743

Donald R. Ulrich
Program Manager
Air Force Office of Scientific Research
Bolling AFB
Washington, DC 20332
202-767-4963, AV 297-4963

Rudy Vallee
Vice President
Nilsen (U.S.A.) Inc.
Glen Court Office Center
1793 Bloomingdale Road, Suite 7
Glendale Heights, IL 60137
312-260-0725

Katherine M. Van Sickle
Spec. Assistant
Dep. Assoc. Sec. for Cons.
U.S. Department of Energy
FORSTL
Washington, DC 20585
202-252-9232

Earl E. VanLandingham
Manager, Automotive Heat Engines
NASA Headquarters
Code REC-1
Washington, DC 20546
202-755-8475

Juris Verzemnieks
Research Engineer
Boeing Aerospace
P.O. Box 3999, MS 73-09
Seattle, WA 98422
206-237-5650

Anil V. Virkar
Assoc. Prof.
University of Utah
(Representing Ceramatec, Inc.)
1875 Suzette Cir.
Salt Lake City, UT
801-487-2000

John B. Wachtman
Scientific Assistant to the Director
National Bureau of Standards
Room B-354, Materials Bldg.
Washington, DC 20234
301-921-2822

Bruce Waechter
Manager-Technical Programs
SKF Industries
1100 First Ave.
King of Prussia, PA 19406
215-265-1900

K. C. Wang
Manager - Industrial Ceramics Research
Harbison-Walker Refractories
Div. Dresser Industries, Inc.
P.O. Box 98037
Pittsburgh, PA 15227
412-562-6200

Steven G. Wax
Capt., USAF
Program Manager
Air Force Office of Scientific Research
Bolling AFB
Washington, DC
202-767-4931

Philip Weinberg
Naval Air Systems Command
Washington, DC 20601
202-692-6025

David O. Welch
Assistant Head of the Metallurgy
and Materials Science Division
Brookhaven National Laboratory
Upton, NY 11973
516-282-3517

Eugene M. Wewerka
Associate Division Leader
Materials Science and Technology Division
Los Alamos National Laboratory, MS G756
Los Alamos, NM 87545
505-667-8269

Thomas J. Whalen
Principal Research Scientist
Ford Motor Co.
Scientific Lab, Room 2023
Dearborn, MI 48121
313-322-2230

Sheldon Wiederhorn
National Bureau of Standards
Washington, DC 20234
301-921-2901

Robert L. Wiley
Manager, Washington Office Liaison for Highway Systems
The Aerospace Corporation
955 L'Enfant Plaza, SW, Suite 4000
Washington, DC 20024
202-488-6055

David G. Wirth
V.P. Technical Operations
Coors Porcelain Co.
Golden, CO 80401
303-277-4200

Mark Wittels
Division of Materials Sciences
ER-132, GTN
U.S. Department of Energy
Washington, DC 20545
301-353-3426, FTS 233-3426

Stanley M. Wolf
Division of Materials Sciences
ER-131, GTN
U.S. Department of Energy
Washington, DC 20545
301-353-3428, FTS 233-3428

Frank E. Woolley
Manager, Applied Process Research
Corning Glass Works
Corning, NY 14830
607-974-3820

Kyral Wylie
Staff
Los Alamos National Laboratory
Group WX-5, G780
P.O. Box 1663
Los Alamos, NM 87545
505-667-8084, FTS 843-8084

Thomas M. Yonushonis
Material Scientist
SKF Industries, Inc.
1100 First Ave.
King of Prussia, PA 19406
215-265-1900, ext 298

A. Zangvil
Senior Research Scientist
University of Illinois
Materials Research Laboratory
104 s. Goodwin Ave.
Urbana, IL 61801
217-333-6829

Anne Marie Zerega
Transp. Industry Analyst
Vehicle & Engine R&D
CE-31, FORSTL
U.S. Department of Energy
Washington, DC 20585
202-252-8053

Klaus M. Zwilsky
Executive Director
National Materials Advisory Board
National Academy of Sciences
2101 Constitution Ave., NW
Washington, DC 20418
202-334-3497



**United States
Department of Energy
Washington, DC 20545**

Postage and Fees Paid
U.S. Department of Energy
DOE-350



Official Business
Penalty for Private Use, \$300