

# X-ray Optics for BES Light Source Facilities

Report of the Basic Energy Sciences Workshop  
on X-ray Optics for BES Light Source Facilities

March 27 - 29, 2013



U.S. DEPARTMENT OF  
**ENERGY**

Office of Science







**Report of the Basic Energy Sciences Workshop  
on X-ray Optics for BES Light Source Facilities**

Potomac, MD / March 27-29, 2013

**CO-CHAIRS**

Dennis Mills  
*Argonne National Laboratory*

Howard Padmore  
*Lawrence Berkeley National Laboratory*

**OFFICE OF BASIC ENERGY SCIENCES CONTACT**

Eliane Lessner  
*Scientific User Facilities Division, Office of Basic Energy Sciences*

# Table of Contents

<b>4</b>	Executive Summary
<b>10</b>	Introduction
<b>20</b>	Grating Optics
<b>32</b>	X-ray Mirrors
<b>44</b>	Optical and X-ray Metrology
<b>56</b>	Simulation and Modeling
<b>68</b>	Nanodiffractive Optics
<b>82</b>	Crystal Optics
<b>94</b>	Thin Film Optics
<b>108</b>	Adaptive X-ray Optics
<b>118</b>	Refractive Optics
<b>130</b>	Models for Facility Operations and Interlaboratory Coordination
<b>136</b>	Industry
<b>142</b>	Agenda
<b>144</b>	Attendees
<b>145</b>	Glossary

# Executive Summary

Each new generation of synchrotron radiation sources has delivered an increase in average brightness 2 to 3 orders of magnitude over the previous generation. The next evolution toward diffraction-limited storage rings will deliver another 3 orders of magnitude increase. For ultrafast experiments, free electron lasers (FELs) deliver 10 orders of magnitude higher peak brightness than storage rings. Our ability to utilize these ultrabright sources, however, is limited by our ability to focus, monochromate, and manipulate these beams with X-ray optics. X-ray optics technology unfortunately lags behind source technology and limits our ability to maximally utilize even today's X-ray sources. With ever more powerful X-ray sources on the horizon, a new generation of X-ray optics must be developed that will allow us to fully utilize these beams of unprecedented brightness.

The increasing brightness of X-ray sources will enable a new generation of measurements that could have revolutionary impact across a broad area of science, if optical systems necessary for transporting and analyzing X-rays can be perfected. The high coherent flux will facilitate new science utilizing techniques in imaging, dynamics, and ultrahigh-resolution spectroscopy. For example, zone-plate-based hard X-ray microscopes are presently used to look deeply into materials, but today's resolution and contrast are restricted by limitations of the current lithography used to manufacture nanodiffractive optics. The large penetration length, combined in principle with very high spatial resolution, is an ideal probe of hierarchically ordered mesoscale materials, if zone-plate focusing systems can be improved. Resonant inelastic X-ray scattering (RIXS) probes a wide range of excitations in materials, from charge-transfer processes to the very soft excitations that cause the collective phenomena in correlated electronic systems. However, although RIXS can probe high-energy excitations, the most exciting and potentially revolutionary science involves soft excitations such as magnons and phonons; in general, these are well below the resolution that can be probed by today's optical systems. The study of these low-energy excitations will only move forward if advances are made in high-resolution gratings for the soft X-ray energy region, and higher-resolution crystal analyzers for the hard X-ray region. In almost all the forefront areas of X-ray science today, the main limitation is our ability to focus, monochromate, and manipulate X-rays at the level required for these advanced measurements.

To address these issues, the U.S. Department of Energy (DOE) Office of Basic Energy Sciences (BES) sponsored a workshop, X-ray Optics for BES Light Source Facilities, which was held March 27-29, 2013, near Washington, D.C. The charge given to the co-chairs of this workshop is given below.

The Department of Energy (DOE), Office of Basic Energy Sciences (BES) is sponsoring this workshop to identify opportunities and needs for X-ray optics developments at the existing and future BES facilities. This workshop will assess the state of the art and future developments, with emphasis on the underlying engineering, science, and technology necessary to realize the next generation of X-ray optics instruments to advance photon-based science. The scope will include adaptive optics, nanodiffractive optics, mirrors, and simulation tools. The workshop will explore opportunities for discovery enabled by advanced X-ray optics, and identify processes to enhance interactions and collaborations among DOE laboratories to most effectively use their resources and skills to advance scientific frontiers in energy-relevant areas, as well as the challenges anticipated by advances in source brightness. Consequently, the workshop has the opportunity to influence BES strategic investment in X-ray optics research.

### **The goals of this workshop are:**

- Evaluate the present state of the art in X-ray optics.
- Identify the gaps in current X-ray capabilities and what developments should have high priority to support current and future photon-based science.
- Identify the engineering, science, and technology challenges.
- Identify methods of interaction and collaboration among the facilities so that resources are most effectively focused onto key problems.
- Generate a report of the workshop activities, including a prioritized list of research directions to address the key challenges.



The workshop addressed a wide range of technical and organizational issues. Eleven working groups were formed in advance of the meeting and sought over several months to define the most pressing problems and emerging opportunities and to propose the best routes forward for a focused R&D program to solve these problems.

We identified eight principal research directions (PRDs), as follows:

- Development of advanced grating lithography and manufacturing for high-energy resolution techniques such as soft X-ray inelastic scattering.
- Development of higher-precision mirrors for brightness preservation through the use of advanced metrology in manufacturing, improvements in manufacturing techniques, and in mechanical mounting and cooling.
- Development of higher-accuracy optical metrology that can be used in manufacturing, verification, and testing of optomechanical systems, as well as at wavelength metrology that can be used for quantification of individual optics and alignment and testing of beamlines.
- Development of an integrated optical modeling and design framework that is designed and maintained specifically for X-ray optics.
- Development of nanolithographic techniques for improved spatial resolution and efficiency of zone plates.
- Development of large, perfect single crystals of materials other than silicon for use as beam splitters, seeding monochromators, and high-resolution analyzers.
- Development of improved thin-film deposition methods for fabrication of multilayer Laue lenses and high-spectral-resolution multilayer gratings.
- Development of supports, actuator technologies, algorithms, and controls to provide fully integrated and robust adaptive X-ray optic systems.
- Development of fabrication processes for refractive lenses in materials other than silicon.

We also addressed two important nontechnical areas: our relationship with industry and organization of optics within the light source facilities. Optimization of activities within these two areas could have an important effect on the effectiveness and efficiency of our overall endeavor. These are crosscutting managerial issues that we identified as areas that needed further in-depth study, but they need to be coordinated above the individual facilities.

Finally, an issue that cuts across many of the optics improvements listed above is routine access to beamlines that ideally are fully dedicated to optics research and/or development. The success of the BES X-ray user facilities in serving a rapidly increasing user community has led to a squeezing of beam time for vital instrumentation activities. Dedicated development beamlines could be shared with other R&D activities, such as detector programs and novel instrument development.

In summary, to meet the challenges of providing the highest-quality X-ray beams for users and to fully utilize the high-brightness sources of today and those that are on the horizon, it will be critical to make strategic investments in X-ray optics R&D. We hope this report can provide guidance and direction for effective use of investments in the field of X-ray optics and potential approaches to develop a better-coordinated program of X-ray optics development within the suite of BES synchrotron radiation facilities. Due to the importance and complexity of the field, the need for tight coordination between BES light source facilities and with industry, as well as the rapid evolution of light source capabilities we recommend holding similar workshops at least biannually

## Summaries from Each Working Group Area

### High-resolution Gratings

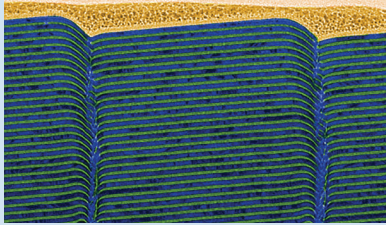

Dramatic enhancement of resolution and throughput in the soft X-ray region can be achieved through development of advanced grating lithography and manufacturing. Along with R&D to push the state of the art, new capabilities with U.S. industry must be developed to solve critical supply problems.

- **Benefits.** Gratings are critical for all soft X-ray measurements. At the frontier of X-ray condensed-matter physics, RIXS is used to elucidate the electronic structure of correlated electronic systems. We have the potential to advance from the 150 meV resolution of today to sub-10 meV resolution and beyond using advanced grating technology. This would be a revolutionary step forward in our quest to understand complex electronic materials.

### Mirrors

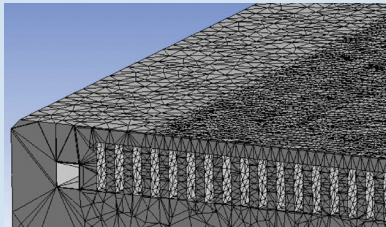

Coherence preservation and nanofocusing require the development of higher-precision mirrors through the use of advanced metrology in manufacturing as well as improvements in manufacturing techniques, mechanical mounting, and cooling. This calls for the development of new metrology tools capable of measuring height and slope errors of  $<0.5$  nm and  $<50$  nrad respectively, and then their deployment at manufacturing sites. Next-generation high-heat-load mirrors will need cryogenic cooling to preserve optical surfaces at the appropriate level of precision.

- **Benefits.** Mirrors are critical components of almost every beamline. Optics presently cannot be manufactured to the precision required for the brightest sources today and are far from what will be needed for next-generation light sources. Mirror perfection is limited by manufacturing precision, mechanical mounting, and thermal management. Investment in these areas will pay huge dividends in terms of achievable precision, allowing us to fully utilize source brightness.

### Metrology

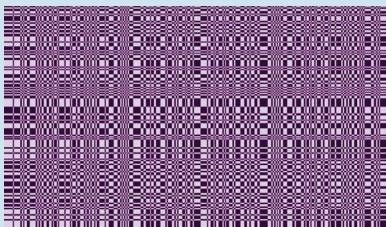

To transport the brightness of state-of-the-art X-ray sources to the sample, optical elements must be manufactured to very high precision and maintain their characteristics under operational conditions in beamlines. Tools are needed to measure the characteristics of optical elements, such as the figure error and roughness of mirrors, or the phase coherence of diffractive optics, such as gratings. These tools must work at optical wavelengths in the laboratory, mainly for the testing of optical elements assembled into complex optomechanical systems, and at X-ray wavelengths to assess operational performance of a complete system and to guide alignment of system components.

- **Benefits.** Advanced metrology tools at the manufacturing site can drive improvements in mirror quality. At-wavelength metrology tools can greatly assist in the diagnostics and control of the optical-system alignment and performance under operational conditions, improving beamline performance and throughput.

## Simulation and Modeling



Sophisticated new modeling and simulation tools are needed for the design of complex optical systems. Today's design and evaluation of optical systems use an incomplete patchwork of codes. We need an integrated optical-design framework developed and maintained specifically for X-ray optics.

- Benefits. Integrated and more sophisticated design tools will allow us to design higher-performance and more sophisticated optical systems with high confidence. Beamline optical systems can cost \$10 million to \$20 million; tools that can aid in their design and accurately predict beamline performance before they are built are absolutely essential for taking the next steps forward.

## Nanodiffractive Optics

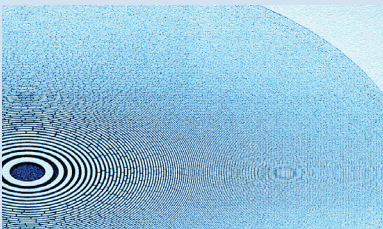

Higher-spatial-resolution and -throughput nanofocusing optics are needed. Limitations of present nanolithography presently constrain soft X-ray zone-plate resolution to 10 nm and hard X-rays to 30 nm. Improvements in resolution and, equally important, efficiency and contrast critically depend on advances in highly specialized nanolithography techniques for X-ray optics.

- Benefits. Spatial resolution in X-ray microscopes is limited by the properties of nanodiffractive optics, such as zone plates. Advances would enable better resolution, particularly at hard X-ray energies, together with higher efficiency. This is particularly important in many areas of energy sciences, where small features must be chemically identified, such as in hierarchically ordered synthetic materials used in energy storage, conversion, and catalysis.

## Crystal Optics



Novel single-crystal optics for beam-splitting and seeding X-ray FELs and new high-resolution crystal optics for hard X-ray RIXS need development. Alternative crystalline materials other than silicon (such as diamond, sapphire, quartz, etc.) must be developed to realize these goals.

- Benefits. Seeding and beam splitting optics for X-ray FELs will allow these sources to provide higher-quality beams and multiplexing capabilities to increase much-needed capacity. Currently, hard X-ray RIXS is severely limited by the unavailability of energy analyzers that perform well at specific X-ray energies (e.g., near atomic absorption edges). RIXS relies on the resonant enhancement of the inelastic X-ray scattering signal to make measurements feasible that would be more difficult or perhaps impossible in a nonresonant mode. To expand the technique's repertoire, suitable analyzers that operate at a variety of specific X-ray energies (corresponding to absorption edges) and that have good energy resolution and high efficiency must be developed.

## Thin Films



New techniques are needed to push the boundaries of spectral and spatial resolution. To improve spatial resolution, multilayer Laue lens (MLL) technology must move to the nm regime. To improve spectral resolution, high-order dense multilayer gratings must be pushed to the fundamental limits set by materials characteristics.

- Benefits. Spatial resolution of grazing-incidence nanofocusing optics and MLL optics could drive toward the nm regime, opening up many new applications requiring large probe depth with extreme resolution, such as in the exploration of hierarchically mesoscale ordered materials. Spectral resolution will be vastly improved, particularly in the soft X-ray domain, opening new possibilities in ultrahigh-resolution RIXS studies of condensed matter.

## Adaptive Optics

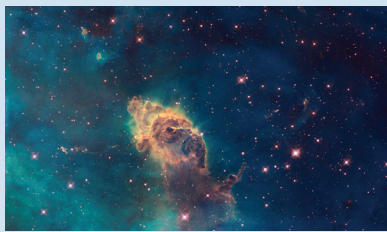

Adaptive optics (AO) have the potential to deliver diffraction-limited performance for coherent light sources beyond the capabilities of fixed mirror systems. R&D of supports, actuator technologies, algorithms, and controls is needed to provide fully integrated and robust AO systems to beamline designers and builders.

- Benefits. AO in astronomy has had revolutionary impact. When applied to X-ray light sources, these techniques will help scientists utilize the ultimate capabilities that modern sources can provide in terms of brightness, wavefront quality, and coherence. AO provides correction of wavefront errors, as well as on-demand beam shaping customized to each science target, and real-time correction of optics under dynamic environmental conditions.

## Refractive Optics

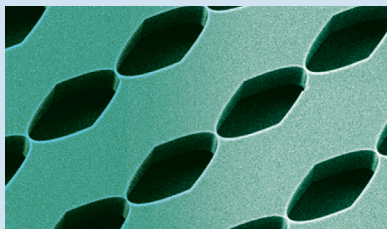

Refractive optics could enable efficient and simple nanofocusing in the hard X-ray region. Crystalline materials other than silicon that are more suitable for refractive lenses need to be identified along with the development of fabrication processes for those materials.

- Benefits. Coherence-preserving compound refractive lenses (CRLs) for focusing in one or two dimensions can lead to significant improvements in experiments where the coherent flux is critical, such as X-ray photon correlation spectroscopy. CRLs are also particularly advantageous for techniques using very-high X-ray energies such as pair distribution function (PDF) measurements, high-energy imaging/diffraction, and high-pressure studies where other types of optics do not perform well. At very-high X-ray energies, refractive optics provide an optimum solution for transport and nanofocusing.

## Optics Facility Organization and Cooperation



An improved cross-facility coordination and cooperation structure is needed. The present structure is built on each facility independently providing an infrastructure to support the science program of its institution, resulting in too much duplication and a stovepiping of resources.

- Benefits. An optimum organization would provide a number of functional models tailored to the services or research needed across the whole X-ray facility complex. Several organizational models should be developed, from the specialized center providing expertise and optics to the whole community, to a delocalized effort across all the labs, with a coordination center. Benefits will be increased efficient and optimum use of limited resources.

## Industry



Better coordination and cooperation with industry is needed. Currently, industry is used as a contracted entity to provide services, making cross-fertilization of ideas or methods difficult. The small market for X-ray optics and the wide diversity of optics add to the problem. Coordination across facilities with industry in areas such as standardization is not optimum.

- Benefits. We have unique challenges that can only be overcome by a new collaborative interaction with industry. The development of a vibrant industry around X-ray optics will be a necessary and key component if the United States is to lead in X-ray science using ultrabright sources.

# Introduction

## Evolution of Synchrotron Radiation Research

Synchrotron radiation is now central to many areas of physical, chemical, and biological science. Its use has grown dramatically over the years — the four Department of Energy (DOE) storage-ring and one free electron laser (FEL) sources serve more than 15,000 users from academia, federally funded laboratories, and industry each year. The unique aspects of synchrotron radiation, in particular ultrahigh brightness, tunability, and polarization control, have been used to advance our knowledge in many areas of science, from understanding the chemistry of ozone-destroying compounds to the electronic structure of complex materials such as high-temperature superconductors. Not only does synchrotron radiation research play a vital role across many areas of academic science, it is also playing an increasing role in areas that directly impact the public. The pharmaceutical industry is using revolutionary structure-based drug-design methods to develop new compounds to treat a wide range of diseases. A broad class of energy research, from polymer photovoltaics to batteries, is using synchrotron radiation X-rays to gain insight into the structure and function of complex designed materials, leading to revolutionary advances in capabilities. X-rays are allowing us to understand new classes of ultra-lightweight and tough high-temperature materials based on hierarchically ordered materials that will potentially revolutionize transport.

As we progress in our use of synchrotron radiation, the ever-increasing brightness of our X-ray sources means that we can conduct measurements that probe systems at ever-increasing detail, for example in spatial or spectral resolution. The first generation of synchrotrons allowed us to probe continuous materials with mm spatial resolution in the hard X-ray region; the second generation allowed us to do microscopy with micron resolution; and now with the third generation we have advanced to less than 50 nm resolution. Further advances in source brightness are allowing us to develop optics and methods that should enable X-ray microscopy at a few nm resolution. In the soft X-ray spectral domain, we have progressed to the point where the new powerful probe of resonant inelastic X-ray scattering (RIXS) can access relatively high-energy excitations with 100 meV resolution, and with expected source and optics advances, we can see a route to the meV energy scale. These low-energy excitations are critical to controlling the behavior of complex correlated electronic materials, and can lead to emergent phenomena such as high-temperature superconductivity. In the hard X-ray regime, (nonresonant) inelastic scattering with a few meV resolution now permits routine measurements of phonon dispersion curves. Once the sole purview of neutron scattering, phonon dispersion curves can be used to determine the compressional wave velocity of alloys at pressures and temperatures found near the Earth's core, providing geochemists better insight into the composition of the inner core.

Driven by scientific need and enabled by the development of brighter sources, we are on the cusp of a new era in which we will be able to probe materials on the finest spatial, electronic, and temporal scales. However, to take advantage of the tremendous advances in source brightness, we need to develop a new generation of X-ray optics that can preserve this brightness and provide the increased performance necessary for cutting-edge measurements.

## Challenges in X-ray Optics for High-brightness Sources

The working-group chapters in this report address in depth the problems and opportunities we face in X-ray optics for synchrotron radiation research. In this section, we comment on some common themes that run through our examination of this topic. The fact that storage-ring-based X-ray sources have increased in brightness by 3 orders of magnitude for each generation — and this is set to continue to the next generation of diffraction-limited sources — and that FEL-based sources have a peak brightness 10 orders of magnitude higher than any other source presents unique challenges and opportunities.

For example, due to the necessarily large scale of synchrotron facilities and the very small source size, the angular size of the source is such that the mirrors we need to focus X-rays must have a deviation from their optimal shape of, in some cases, around 50 nrad (rms). For focusing of coherent beams, the height deviation of a mirror must be less than 1 nm for optical elements up to 1 m in length. The difficulty achieving and maintaining these requirements is exacerbated by the fact that some optics have to absorb hundreds of watts of X-ray power. Optics tolerances for next-generation sources will be tighter again. Not only does this set stringent criteria for design and manufacture, it also sets very difficult goals for the metrology of optical systems, in which we need to examine elements that are mounted, cooled, and manipulated typically in an ultra-high-vacuum environment. The issues involving R&D, production, and measurement of optics are explained in depth in the following technical chapters of this report. Most of these issues can be dealt with through focused efforts coordinated between the light-source laboratories and the range of X-ray optics expertise within the United States, if this work is supported by adequate funding.

A general issue in the procurement of mirror and grating optics is the small volume and large diversity of the optics needed. Although we require optics that are extremely challenging, with specifications at, or in some cases well beyond the state of the art, the total U.S. volume is low and diversity is high. The total market for synchrotron mirrors and gratings per year is no more than \$5 million, and the optics we require are highly specialized to synchrotron radiation research. This contrasts with astronomy, where, for example, in the James Webb Space

### X-ray Microscopy for Energy Science

X-ray microscopy can probe deeply into materials and reveal their physical and chemical structure. Scanning zone-plate-based microscopes currently reach resolutions of 15 nm (soft X-ray) and 50 nm (hard X-ray) with reasonable efficiency. Improvements in resolution to 5 nm and lower are envisaged with advances in nanolithography. Improvements in efficiency are necessary, particularly in the hard X-ray region, to improve both signal and contrast.

Battery materials should be understood better so that performance can be improved. For example, in an iron phosphate-based lithium-ion battery electrode, Li is transported into and out of the  $\text{FePO}_4$  during charging and discharging. How efficiently this process can occur is linked to how completely and rapidly  $\text{FePO}_4$  grains can be intercalated. A combination of spectroscopy and zone-plate scanning X-ray microscopy can reveal this process in situ (*top: Chueh et al., Nano. Lett. 13, 866, 2013*). Higher resolution is required to access the size scale of new nanocrystalline battery materials, and to look at the structure of the solid-electrolyte interface (bottom).

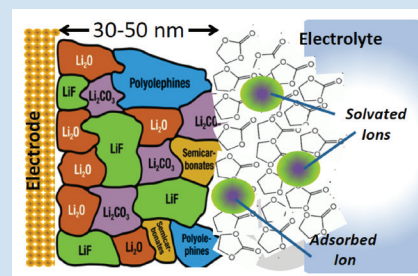
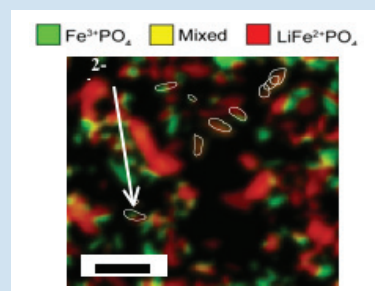

## Resonant Inelastic X-ray Scattering (RIXS): A Revolutionary New Probe of Complex Materials

RIXS is a photon-in/photon-out technique in which a photon is scattered off a sample, changing its energy, momentum, and polarization. These changes in the scattered photon are directly reflective of the intrinsic elementary excitations of the solid, ranging from eV energy-scale charge transfer to meV energy-scale phonon excitations. Two scattering mechanisms can be involved in transfer of energy and momentum: the usually dominant direct process (left) and the indirect process (right).

(Figures from Ament et al., *Rev. Mod. Phys.*, 83,705-767, 2011)

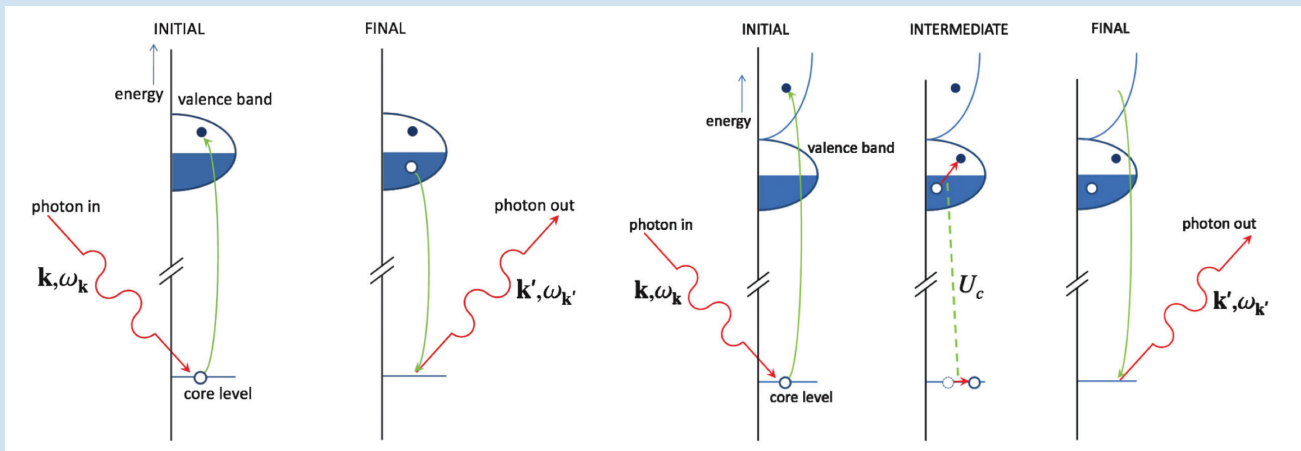
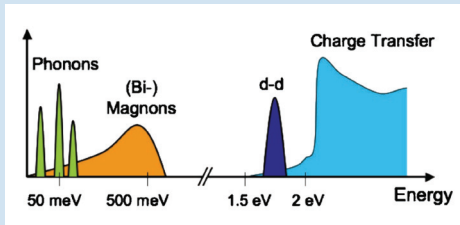

State-of-the-art RIXS energy-loss spectrum from bulk  $\text{La}_2\text{CuO}_4$ . This spectrum shows an anisotropic magnon excitation. Such spectra are an important new tool in understanding correlated electronic materials, such as high-temperature superconductivity. It can be seen that the instrumental resolution, given by restrictions of present optics, masks much of the underlying structure. Reduction of the resolution from 100 meV today to a few meV is urgently needed. (Figure from Dean et al., *Nature Materials* 11, 850-854, 2012)

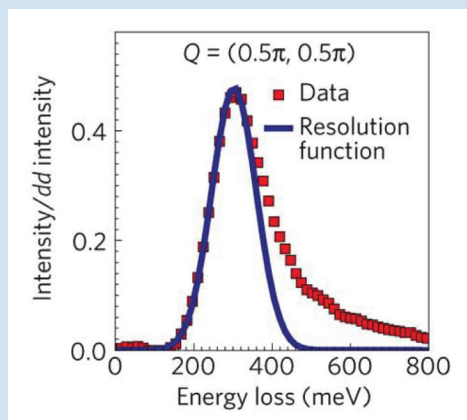
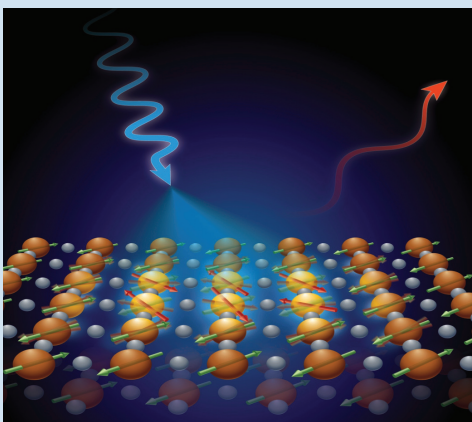

## Storage Rings Are Getting Ever Brighter

The highest-brightness X-rays from a storage ring are emitted by undulators, long arrays of periodic magnets. Light from the undulator is conditioned, focused, and monochromatized by optical elements within each beamline. The experimental station at the end of the beamline can also have an optical system to focus X-rays onto a sample, or analyze X-rays scattered from or emitted by a sample.

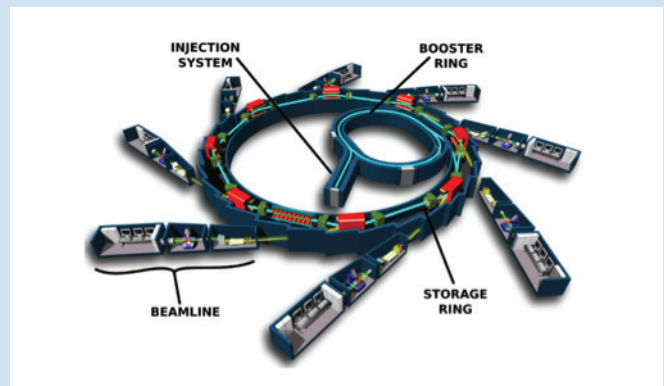

The average brightness of present-day storage rings (light gray) is set to be superseded in the next few years by up to 3 orders of magnitude and achieve diffraction-limited performance. This follows the historical trend where each generation of machine is 3 orders brighter than the previous. This will primarily be accomplished by reduction of the horizontal beam emittance.

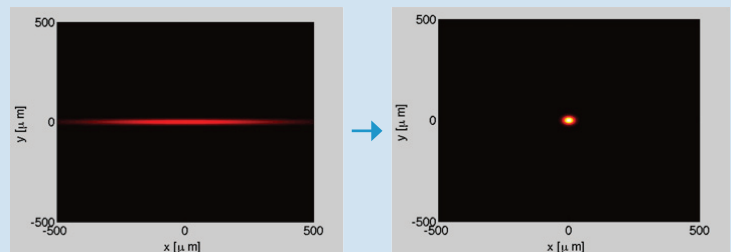
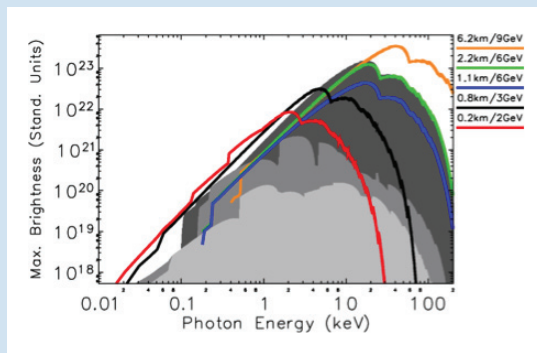

Telescope, 18 identical hexagonal mirrors were needed with identical specifications, with a cost of \$10 million each. Another example is the approximately \$50 million for the full-field exposure tool optics being developed for extreme ultraviolet (EUV) lithography, again where many identical systems will be needed. Due to these challenges, only a very small number of U.S. companies have the capability to manufacture the optics needed, and they do not have the market volume that would encourage the development of techniques to produce next-generation optical elements. These are complex issues and are examined in the *Industry* chapter of this report.

One of the areas that should be highlighted is the importance of theory and simulation. The tools we use today, such as classical ray tracing and optical path function theory, are largely extrapolations of techniques developed for second-generation incoherent synchrotron sources. Although sophisticated commercial codes are available for simulating the transmission of coherent light through optical systems, these are in many ways unsuitable for the needs of synchrotron optics. We have long, partially coherent undulator sources; extreme grazing incidence optics; and many other aspects unique to our area of optics that are not accessible within standard codes. In the United States, even the development of standard ray-tracing codes that have become essential to our work were not directly funded. The situation for third- and fourth-generation sources is even more dire, as we are designing optical systems in which we must deal with full or partial coherence, transient phenomena (such as very short pulses or instantaneous heating), dynamical alignment through adaptive optics, and many other very complex situations. Only if we have comprehensive theory and simulation will we be able to take full advantage of our ultrabright X-ray sources. This issue is dealt with in the *Simulation and Modeling* chapter of this report.



## Free Electron Lasers Give Ultrahigh Peak Brightness

The LCLS at SLAC is the world's first X-ray free electron laser (FEL). Pulses of electrons are accelerated to 14 GeV, compressed in time, and then injected into a 112-m-long undulator. The electric field of the emitted light causes electrons to be bunched, leading to increased emission and eventual saturated emission of coherent X-rays. Pulse lengths are typically in the range of 10 to 100 fsec.

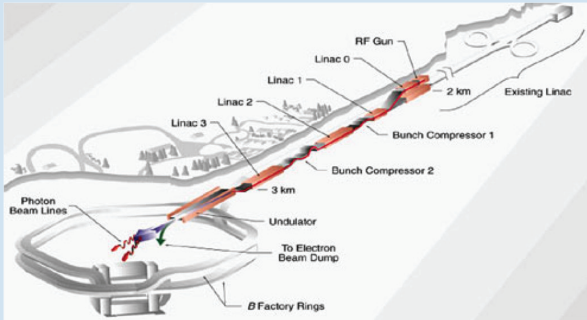

FELs give approximately 10 orders of magnitude higher peak brightness than conventional third-generation storage rings. They operate at a typically low repetition rate compared with storage rings. The few-fsec pulse lengths and very high peak power make them the ideal source for observing ultrafast phenomena.

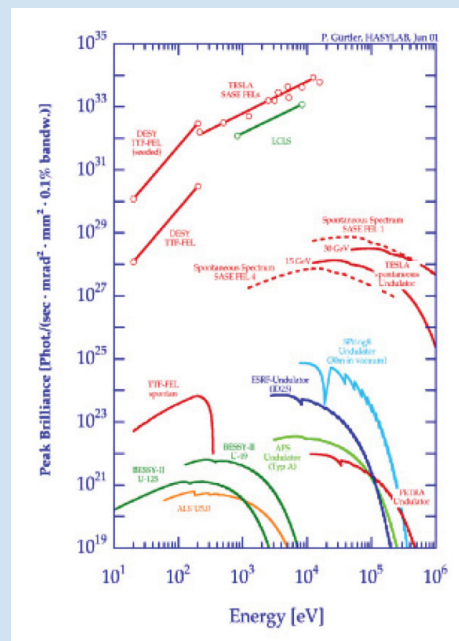

Some challenges are organizational in nature. Resources tend to be stovepiped within individual laboratories and not readily accessible to the whole community. Part of this stems from the way light-source facilities are funded to provide a service for their set of users. Laboratories within the facilities only have the funding and mandate to serve the local community, not the national community. At one level, this leads to duplication of effort and inefficiencies; at another level, it inhibits the pooling of resources that would enable us to tackle the most difficult problems of scale. For example, tasks that require very expensive infrastructure, such as nanolithography for zone-plate optics, require resources focused in one or two centers. In other areas such as theory, the effort can be delocalized throughout the light-source complex, but funding is needed for overall coordination and leadership within defined key areas. There are clearly no universal models for support of X-ray optics and in the *Models for Facility Operations and Interlaboratory Coordination* chapter, we look at how different functions map onto different organizational models.

The accelerator-physics community has provided us with sources of unprecedented brightness and is developing ever-more-powerful machines. Next-generation high-repetition-rate FELs may be the ultimate sources to examine ultrafast dynamics. Diffraction-limited storage rings may be the ultimate quasi CW sources for microscopy and fluctuation dynamics. However, we face enormous challenges in X-ray optics in order to optimally utilize the machines we have today and exploit these revolutionary machines of tomorrow. In this report, we map out a step-by-step analysis of the current situation and provide a road map for creating a new generation of X-ray optics to fully meet these challenges.

## Workshop Charge and Organization

The goals of the workshop as expressed in the DOE charge letter were to:

- Evaluate the present state of the art in X-ray optics.
- Identify the gaps in current X-ray capabilities and what developments should have high priority to support current and future photon-based science.
- Identify the engineering, science, and technology challenges.
- Identify methods of interaction and collaboration among the facilities so that resources are most effectively focused onto key problems.
- Generate a report of the workshop activities, including a prioritized list of research directions to address the key challenges.

The workshop was attended by X-ray optics experts from the DOE light sources, from Oak Ridge National Laboratory (ORNL) and Lawrence Livermore National Laboratory (LLNL), from academia, from the National Institute of Standards and Technology (NIST), and from the National Aeronautics and Space Administration (NASA) as well as by representatives from the optics-manufacturing industry, by beamline scientists responsible for user programs, and by senior managers from the DOE Office of Basic Energy Sciences. We also had representation from senior optics and instrumentation experts from Europe and Japan to provide an international perspective.

This workshop built on two smaller meetings held in the previous 12 months, at Berkeley Lab and Argonne National Laboratory, in which leaders in many X-ray optics fields met to assess the state of X-ray optics in the United States and to try to determine useful directions for future R&D and collaborative research. We established 11 areas that should be considered, from the purely technical to ones that address organizational issues. This DOE-sponsored workshop in X-ray optics built on this foundation, and we adopted the basic structure established in the previous meetings. With the depth of analysis required, we knew the workshop would only be successful if we did considerable work before the meeting, so we established an organizational structure in which each area had two working-group leaders, and these leaders were responsible for recruiting team members to help gather information. The function of the working-group leaders was to collect information from the community and condense this down to a summary for the meeting. To this end, the working-group leaders were asked to address a set of key issues, set out the scope of the area considered, present specific issues, and map out potential solutions that could be investigated in a focused R&D program. This workshop report contains reports from each of the working groups. This format enabled us to treat each topic in considerable depth and to reach out to a broad spectrum of experts, bringing the best and brightest minds to bear on the problems and opportunities in X-ray optics research for synchrotron radiation research.

The workshop identified many common themes and clearly identified our most pressing problems and the best routes to solving them. These themes and ideas were brought together by the workshop co-chairs and are expressed in the *Executive Summary*.

## A Typical Soft X-ray Beamline

In this modern beamline design (the Advanced Light Source [ALS] MAESTRO project), high-intensity light from an undulator source is focused with an internally water-cooled metal pre-mirror. Light is then deflected at variable angles by a plane-side-cooled Si mirror, and then into a grating that disperses the light across the exit slit in the vertical direction. Light is then relayed using a toroidal mirror to downstream experimental stations, where it is further focused and manipulated. Mirrors and gratings typically are 200–500 mm in length.

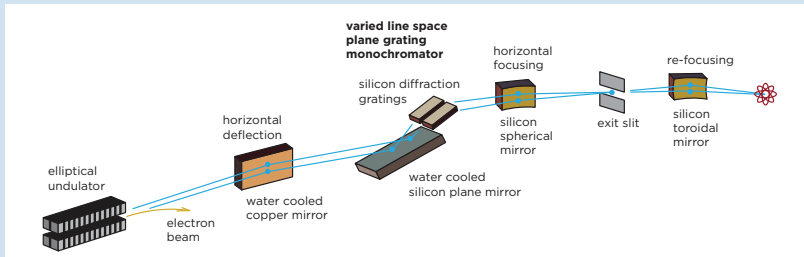

The pre-mirror in this case is made of super-polished nickel-plated copper over-coated with gold and has cooling channels running 1.5 mm from the irradiated surface. Tangential deviations from the correct figure need to be less than  $1 \mu\text{rad}$  to preserve source brightness, and high-frequency surface roughness must be less than 0.3 nm rms. This mirror must maintain these values while absorbing tens of watts of power.

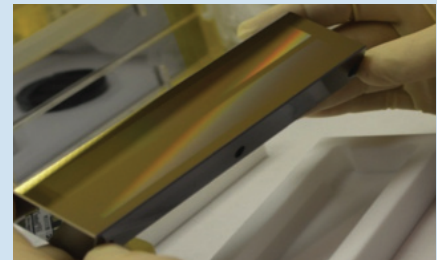
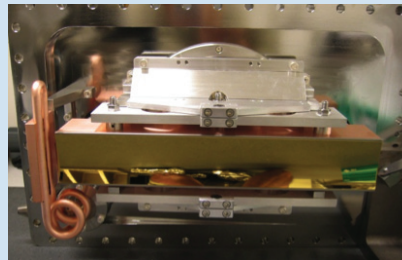

The grating is made of silicon and back-face cooled through a liquid gallium-indium bath. The grating structure is made so that the line density varies along the long length of the grating by a few percent, providing focusing and aberration correction. The grating grooves in this case are rectangular and ion-etched to be 10 nm deep.

The mechanical systems that hold the nanometer-precision X-ray optics themselves must be made to extreme precision, commensurate with source brightness. In this case, the monochromator houses a water-cooled variable-angle mirror and a set of gratings that can rotate and which are side cooled. Stability of this optomechanical system has to be at the level of 20 nrad, from tens of msec to hours. The integration, alignment, and metrology of optics within these complex optomechanical assemblies are a major challenge.

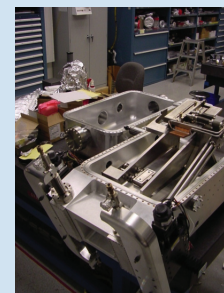

This mirror is used to refocus light onto a downstream experimental station, where further optics microfocus and manipulate the X-ray beam. This mirror is uncooled due to the low incident power after monochromatization and is longitudinally shaped by bending. The bending mechanism allows the focus position to be moved to one of several longitudinal positions in different experimental stations.

## Ultrahigh Precision of Optomechanical Systems Is Required

Optical elements must be manufactured to extremely high precision. In the case of the design of a front-end high-power soft X-ray mirror shown here, the mirror has to absorb approximately 200 W of power, and yet its surface must remain the correct shape to sub- $\mu$ rad slope and nm height precision for an optical element 300 mm long. Its high-frequency surface smoothness must be less than 0.3 nm for good X-ray reflectivity. Optical elements therefore must be rigorously designed, assessing deviations from the correct shape from thermal, mounting, and gravity forces. The mirror shown here is hollow, with high-pressure water running 1.5 mm beneath the optical surface to dissipate the high heat load.

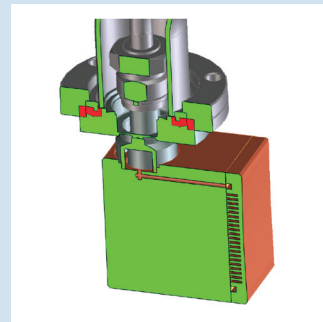
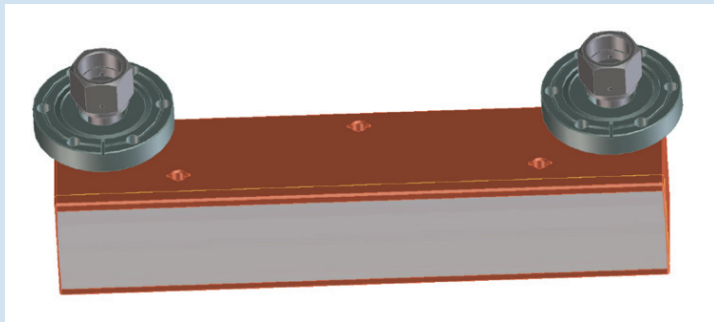

Internally water-cooled copper mirror (left) and a section through the mirror (right).

Mirrors are designed using Finite Element Analysis (left) that can predict distortions from external forces due to heating (right), cooling, gravity, and mounting. In this case, the sum of these errors is in the range of  $\mu$ rads and nms

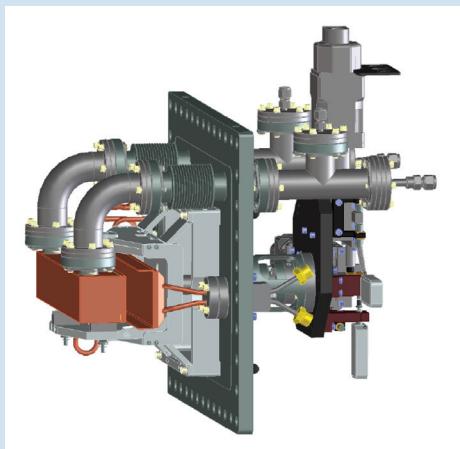
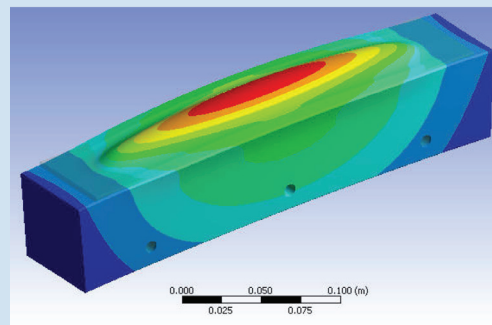
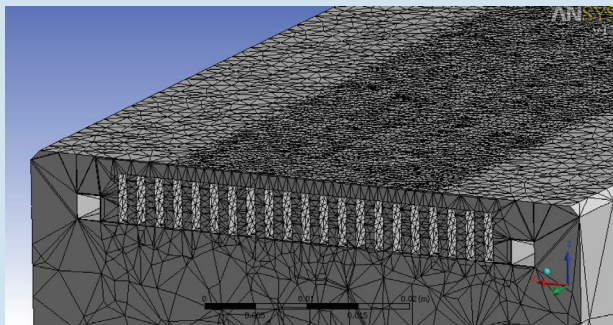

Optical elements must be mounted in such a way that the mounting doesn't distort the mirror surface, and so that the mirror can be steered in angle, to dynamically compensate for changes in source position or position of the beamline. In this case, a soft X-ray mirror is mounted on an actuator and the whole assembly will be used in a mirror vacuum tank in ultrahigh vacuum conditions. The pointing precision of such a mirror assembly must be typically at the level of 0.5  $\mu$ rads, i.e., for the 300 mm mirror shown, one end has to be capable of moving in steps of 75 nm. Due to the 20:1 vertical-horizontal beam size asymmetry of the source, a vertical focusing mirror would need to move in steps 20 times smaller. Extreme precision is required for the manufacture of mirrors and also for their mounting, manipulation, and metrology.

## A Typical Hard X-Ray Beamline

The Hard X-ray Nanoprobe beamline, operated jointly by the Center for Nanoscale Materials (CNM) and APS at Argonne, is a state-of-the-art hard X-ray beamline for scanning and full-field imaging.

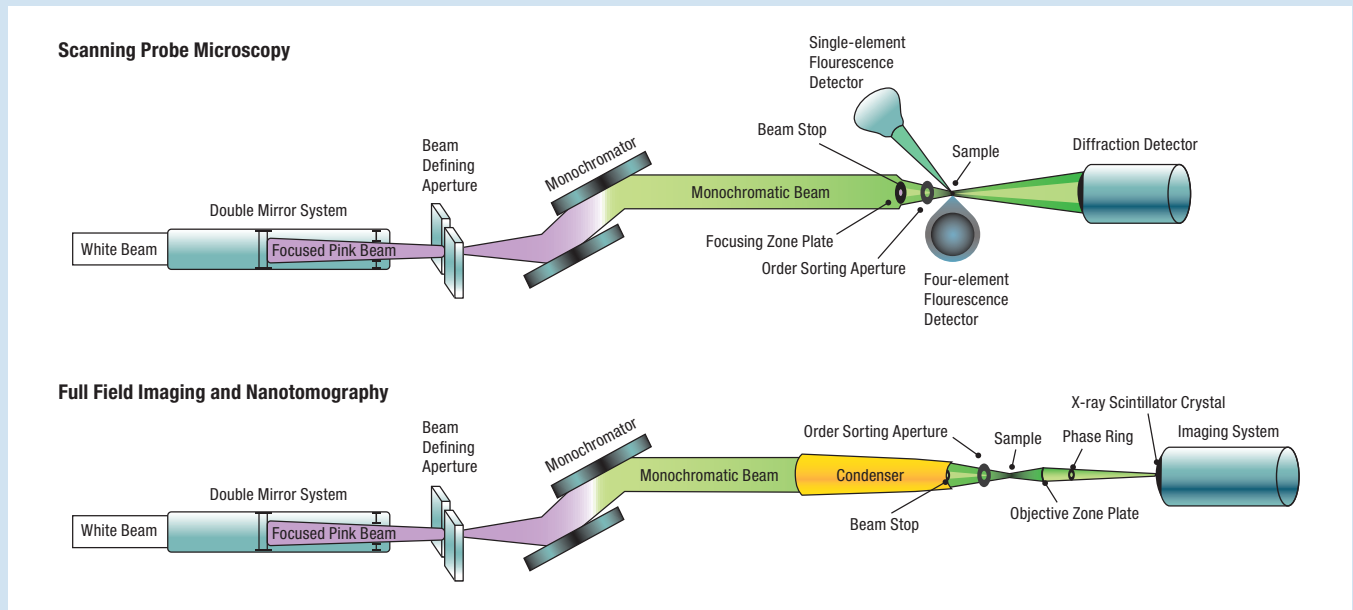

A high-brightness X-ray beam from two collinear undulators is filtered and focused by a double-mirror system to a beam-defining aperture. The mirrors on the nanoprobe beamline are single-crystal substrates with several striped coatings used to remove the high-energy portion of the x-ray spectrum emitted by the undulators. The first mirror, which is water cooled, can be bent to a cylindrical figure with a mechanical bender to focus the diverging incident beam. The figure on the left shows a typical water-cooled x-ray mirror being assembled in a cleanroom.

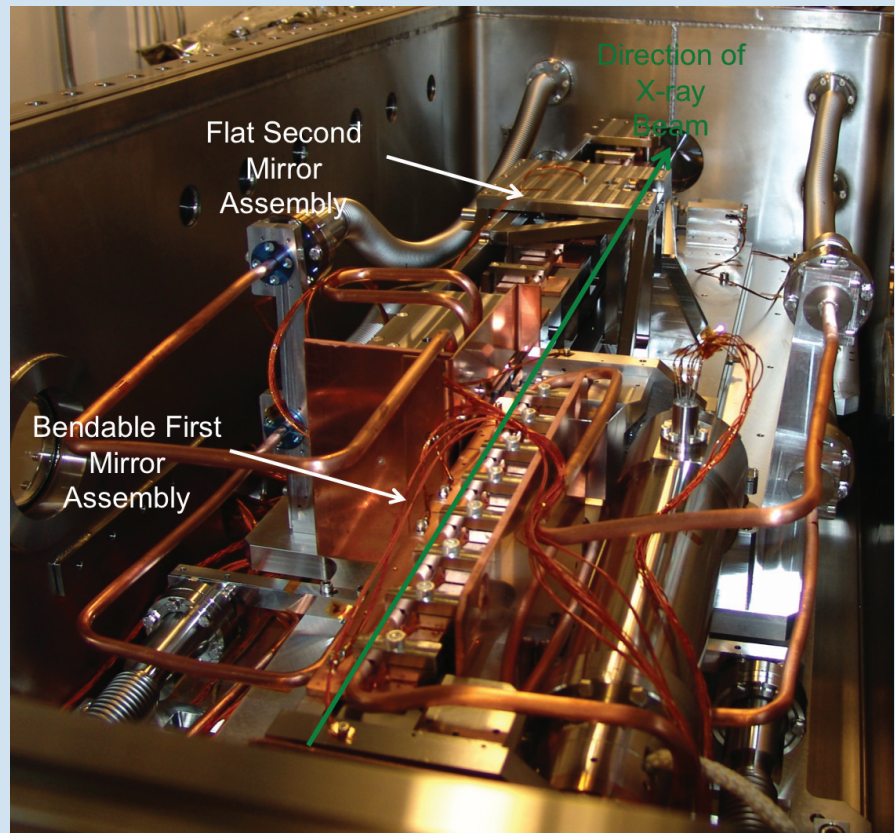

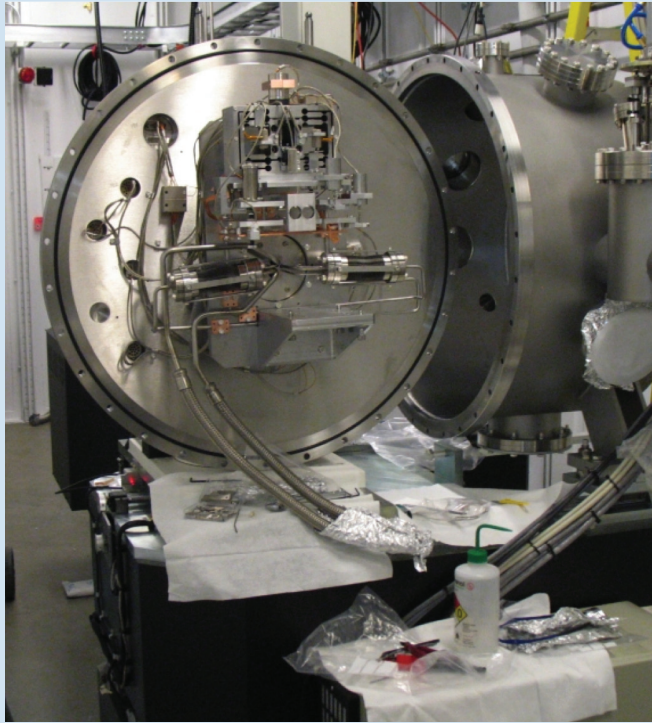

The mirror system delivers the beam to double-crystal monochromator to select photon energies between 6 to 12 keV with a bandpass of  $\sim 0.01\%$ . The silicon crystals in the monochromator are liquid-nitrogen cooled (left) to minimize thermal distortion and preserve the wavefront quality of the X-ray beam for the imaging instrument in the end-station. The end-station instrument operates in both scanning probe and full-field imaging modes. In scanning-probe mode, a hard X-ray Fresnel zone plate focuses the beam from the monochromator to a diffraction-limited spot onto the sample. Focal spot sizes around 30 nm are routinely used for experiments, in which either the emitted fluorescence or diffracted X-rays are measured. This mode is also used for scanning coherent diffractive imaging experiments at sub-10 nm resolution. In the full-field transmission mode, the beam from the monochromator is directed onto a capillary condenser that focuses the X-rays onto the sample. A zone plate after the sample collects the transmitted X-rays and images the sample onto an area detector. Samples can be rotated through  $360^\circ$  under computer control for nanotomography measurements in this imaging mode. Beam parameters provided by beamline for these imaging modes are (1), an intense tunable coherent X-ray beam;

(2), a flat beam profile with minimal structure, and (3) long-term beam stability for experiments that may last over many hours. The use of a secondary effective source (the beam-defining aperture) in the beamline optical design enables the Hard X-ray Nanoprobe to provide these beam parameters, which are essential for reaching the nanoscale spatial resolution required by the science mission of the beamline.

A zone plate after the sample collects the transmitted x-rays and images the sample onto an area detector. Samples can be rotated through  $360^\circ$  under computer control for nanotomography measurements in this imaging mode. The end-station instrument operates in both scanning probe and full-field imaging modes. In scanning probe mode, a hard x-ray The sample chamber, shown in a photograph below, has three detection modes used for nanoscale imaging; diffraction, fluorescence for elemental mapping, and transmission. Low vibration levels are crucial for high spatial resolution work and so the entire microscope (zone plates, sample, and detectors) is mounted on a massive granite block for stability.

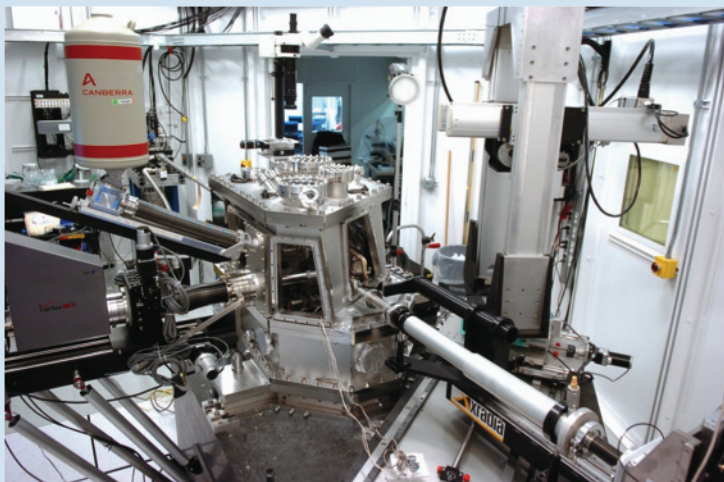

# Grating Optics

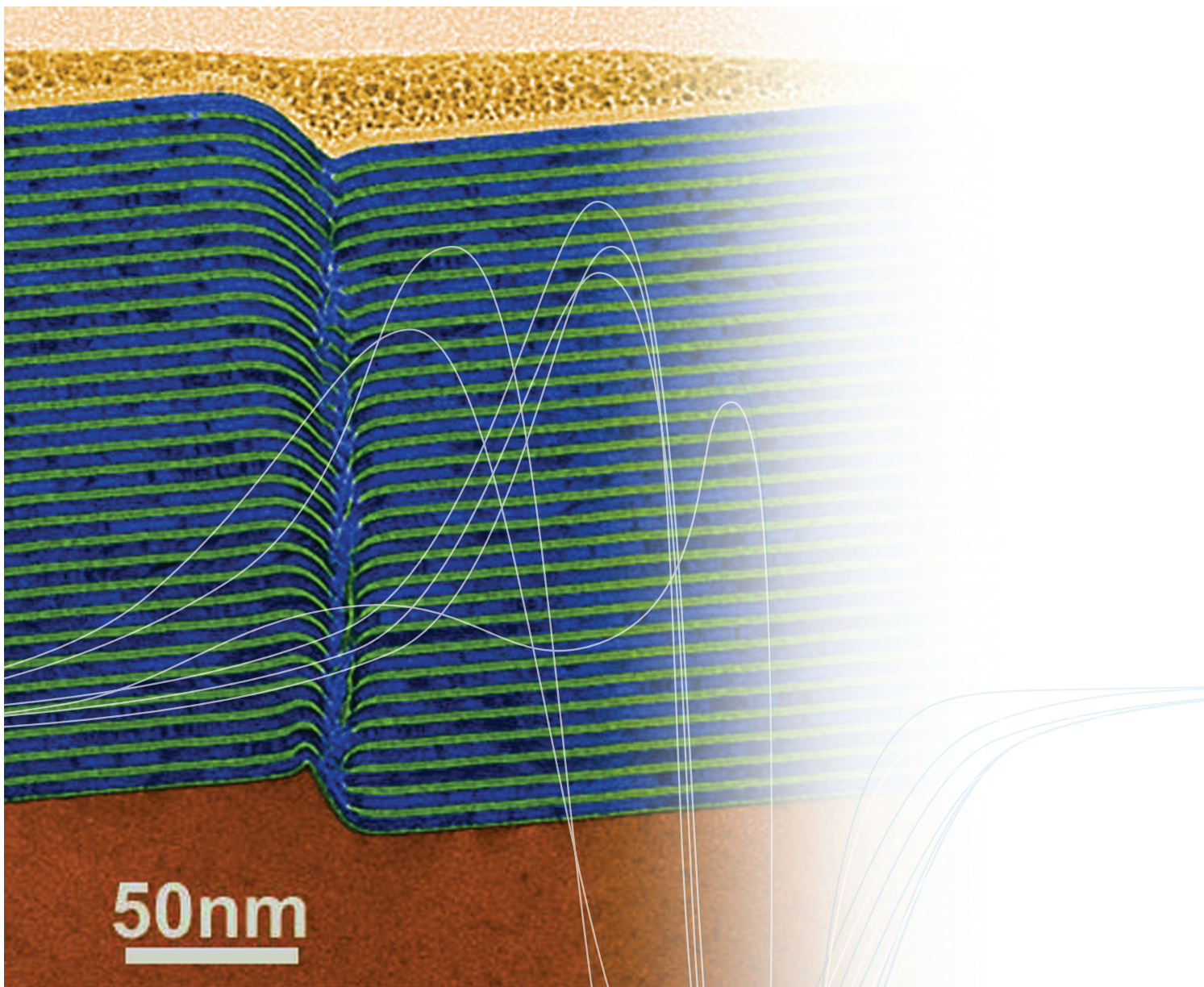

## Summary

Gratings are *the* key element in all vacuum ultraviolet (VUV) and soft X-ray (SXR) beamlines, as they disperse X-rays into a range of angles, dependent on wavelength. This dispersion allows us to monochromatize a broadband X-ray source, and also analyze the X-rays emitted or scattered from a sample. Although grating technology dates back more than a century, significant challenges have arisen from a new generation of experiments and, at the same time, new opportunities have arisen due to the advent of advanced manufacturing techniques. Here we summarize three areas that should be addressed, and map out potential avenues for R&D.

### Working Group Chairs:

D. Cocco (SLAC)  
T. Warwick (LBNL)

### List of contributors in alphabetical order:

P. Abbamonte (Illinois)  
J. Britten (LLNL)  
Y. Chuang (LBNL)  
A. Cotel (Horiba Jobin Yvon)  
L. Donghui (SLAC)  
J. Dvorak (BNL)  
A. Erko (HZB)  
E. Gullikson (LBNL)  
J. Guo (LBNL)  
S. Hau-Riege (LLNL)  
R. Heilmann (MIT)  
P. Heiman (SLAC)  
M. Idir (BNL)  
A. Khounsary (ANL)  
Y. Makino (Shimadzu)  
B. Nelles (DIOS GmbH)  
H. Padmore (LBNL)  
R. Reininger (ANL)  
A. Sakdinawat (SLAC)  
C. Sanchez-Hanke (BNL)  
F. Siewert (HZB)  
D. Smith (PGL)  
D. Voronov (LBNL)

- Resonant inelastic X-ray scattering (RIXS) is a relatively new technique that potentially will revolutionize our understanding of condensed matter through its ability to extract element-specific information on the low-energy excitations that govern the behavior of complex materials. However, conventional RIXS is severely limited in resolution by the characteristics of the gratings used, in both resolution and throughput. An improvement in resolution by 1 to 2 orders of magnitude, enabled by more advanced gratings, would revolutionize the field. To effectively use this narrower bandwidth, improved efficiency is required, requiring advances in grating and spectrometer design.
- Free-electron lasers (FELs) have brought some completely new demands for grating optics. Soft X-ray FELs require long gratings used at extreme grazing angles so as to avoid impulsive damage and consequently require very small angle blazed facets. These gratings are not currently available and neither FEL self-seeding nor high-resolution time-resolved spectroscopy can be optimally developed without these optical elements.
- The supply of diffraction gratings for synchrotron and FEL facilities is limited by the small number of commercial manufacturers. There are currently only three companies supplying gratings to this specialized field worldwide, with none in the United States. The development of grating technology is largely driven by the very large market for optical gratings. The market for highly specialized and complex X-ray gratings, however, is small, and although of vital importance to the X-ray community, the size of the market means that the area is underserved. At the same time, revolutionary electron beam and optical lithography has been developed for other technological areas that could potentially revolutionize grating production. In addition, 3-D multilayer gratings offer numerous advantages over conventional gratings, but are complex and need development to turn their potential into reality.

To address the needs in these three areas, we make the following recommendations for future investments in grating technology and science.



## RECOMMENDATION

- 1. Work with industry to develop domestic manufacturing capability for varied line-space blazed gratings. This includes gratings up to 600 mm long and with line densities from 100 lines/mm to 6,000 lines/mm.** Numerous beamline facilities at synchrotrons and FELs in the United States (at the Advanced Light Source [ALS], the Advanced Photon Source [APS], the National Synchrotron Light Source [NSLS] and SLAC) are dedicated to soft X-ray research. The demand for diffraction gratings is growing. Poor availability of gratings is constraining the design and implementation of monochromators and spectrometers. It is essential to improve the availability and quality of these key components.
- 2. Work with industry to investigate and exploit new high-precision patterning techniques for arbitrary grating patterns written at high speed.** Fixed-field interference lithography for patterning gratings is a developed technique, but has limitations in creating precisely varied ruling patterns. Traditional ruling techniques, with arbitrary groove placement, are slow. New technologies such as shaped electron beam lithography and various forms of direct-write optical lithography are being developed primarily for micro-electronics and telecommunications applications and could be applied to great advantage in fabrication of X-ray gratings. Investment in the development and use of these techniques applied to the specific needs of X-ray gratings is required.
- 3. Develop multilayer gratings on shallow-blazed substrates.** Multilayer gratings hold great promise for ultra-high-resolution spectrometers of moderate size and high efficiency. It has been shown that as in the optical domain, these gratings can work with X-rays in high spectral order with high efficiency, potentially revolutionizing high-resolution spectroscopy. Fundamental research is required to further develop the manufacturing techniques, and ultimately the technology needs to be transferred to a commercial vendor.
- 4. Explore innovative grating configurations for particular applications, such as transmission gratings for use in medium-resolution spectrometers.** Energy-resolved X-ray fluorescence is a powerful probe of chemical structure. One issue with this technique is that although X-rays are emitted into  $2\pi$ , only a very small fraction of this angular aperture can be collected and analyzed. Several potential solutions exist, one being to make use of the very large collection aperture of transmission gratings, or arrays of transmission gratings. These have been developed for X-ray astronomy and a new generation of blazed gratings holds great promise for synchrotron use.

## Scope

The selection and measurement of the wavelength of X-rays is central to all types of experiments in soft X-ray science. Soft X-ray absorption spectroscopy and imaging requires a grating to produce a narrow bandwidth whose central energy can be swept over a defined range. Soft X-ray fluorescence and RIXS require a grating to produce a dispersed spectrum on a detector of photons emitted from a sample.

Soft X-ray gratings are reflection gratings and operate at grazing incidence, below the critical angle for total reflection at the relevant wavelength. Grazing angles are typically a few degrees. They are large — typically several hundred millimeters long — because the footprint of the illumination is elongated at grazing incidence. The requirements for surface figure are stringent. The typical tolerance for surface-slope errors in a modern synchrotron beamline can be as low as 100 nrad rms with 1 nm rms height error. These tolerances directly follow from the requirement for high resolving power,  $R = E/dE$ , where  $dE$  represents the photon energy bandpass and  $E$  represents the photon energy. A typical high-resolution soft X-ray monochromator today has a resolving power of  $\sim 10,000$ , i.e., a bandpass of 0.1 eV at 1 keV photon energy.

Gratings used to monochromatize undulator sources have to be cooled to reduce surface thermal deformation to tolerable values, due to the high power in the incident beam. Typically, beamline gratings are designed to absorb tens of watts of power, while maintaining the very tight tolerances on slope and height given above. The substrate surfaces are either plane or spherical, and are side-cooled in the case of silicon substrates, or internally cooled in the case of metal substrates. Groove patterns are produced in several ways. For the past

100 years, the traditional way to make gratings has been to rule lines with a diamond tool directly into a soft metal such as gold deposited onto the grating surface. This structure is then coated with a thin layer (20 nm) of the reflector needed for the design wavelength range. The ruling engine is typically a massive mechanical structure controlled by a laser interferometer and has proved remarkably successful in producing high-quality gratings. A second method of grating manufacture has been to use optical holography to record a grating pattern in photoresist, then to transfer it to a substrate using ion etching. This method is fast and eliminates the scattered light and sidebands that can be produced by mechanically ruled gratings. Ruling density requirements for soft X-rays cover a range from typically 50 lines/mm up to 5,000 lines/mm and the profile of the grooves must be designed for high efficiency in the wavelength range of interest. Groove profile design is critical in optimizing the grating efficiency. The groove cross section can be sinusoidal (not often used), lamellar (rectangular shape), or blazed (also called echelette or sawtooth profile). Grooves are often very shallow, with typical heights from 3 – 15 nm, requiring precision nanolithography for their production.

Because the ruled line density determines the diffraction angle, variation of the line density along the grating can provide aberration-corrected focusing if sufficient control can be achieved on the placement of the grooves. This capability is exploited widely in modern optical designs. Special geometries for interference lithography provide some control of the variable line space, but mechanical ruling machines provide much more flexible patterning, although the required precision is challenging. Along with an optimized groove profile, the reflectivity of the grating surface is critical to achieve high diffraction efficiency. Operation above 1.5 keV requires very small grazing angles, resulting in shallow grooves or a shallow blaze angle; alternatively, a multilayer coating may be used. Multilayer gratings work farther from a grazing incidence geometry and offer increased dispersion with high efficiency for higher spectral resolution but have some restrictions in terms of tuning range and monochromator geometry.

In summary, gratings are the most important component of a soft X-ray beamline or spectrometer. A high-quality grating is essential to achieve the instrument's design resolution and efficiency. Design parameters vary widely and the availability of gratings is currently a major constraint on optical designs. Many novel schemes require gratings that are presently not available. This is true at currently operational synchrotron beamlines and promises to become yet more critical at new sources that produce highly coherent, fully diffraction-limited beams. We are, however, at a point where several new technologies potentially are set to revolutionize the production of gratings and open new possibilities in optical system design.

## Issues

Current and future soft X-ray projects at BES light-source facilities are predicated on the availability of gratings with exacting specifications. Due to present limitations of manufacturing techniques and manufacturing capacity, very often non-optimum solutions are used. Here we will outline the main limiting factors.

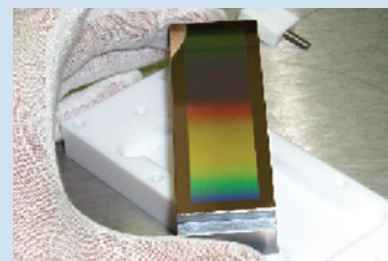

Gratings are ruled on a precisely polished optical substrate. Silicon is preferred for polishing and for its thermal properties. Varied line-space blazed gratings are favored. Ruled lengths are currently of the order 100 mm-200 mm with an imminent need for longer gratings, up to about 500 mm. Cooling schemes involve contact of the back or sides to water-cooled holders. Increased heat loads at FEL facilities will require substrates with internal cooling channels, and operation of silicon gratings at cryogenic temperatures.

Diffraction gratings are used in soft X-ray instrumentation to disperse and select the wavelength of the illuminating radiation or of the radiation emitted by a sample under study. They are artificial periodic structures with a period  $d$ . At the grating, the incoming and outgoing radiation directions are related by a simple formula:

$$\frac{m\lambda}{d} = \sin(\alpha) + \sin(\beta)$$

$d$  is the grating period,  $\alpha$  is the angle of incidence, and  $\beta$  is the angle of diffraction, both with respect to rotation from the normal;  $m$  is the diffraction order and  $\lambda$  is the wavelength of the selected radiation. In the direction of the diffracted beam, there is a difference in path from groove to groove equal to an integer multiple of the radiation wavelength. The diffracted beam generally contains multiple orders with one, two, three times the lowest energy, and so on, usually with decreasing efficiency.

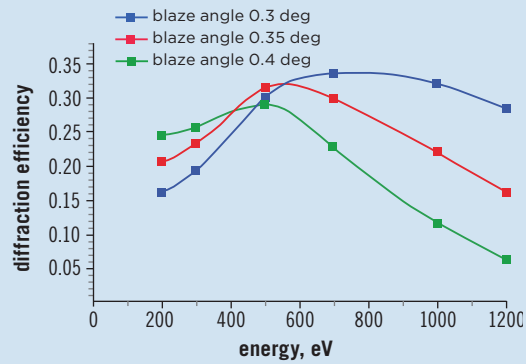
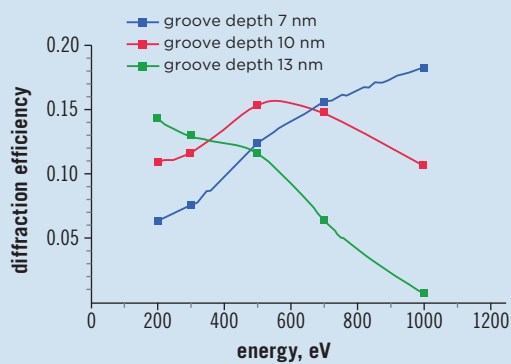
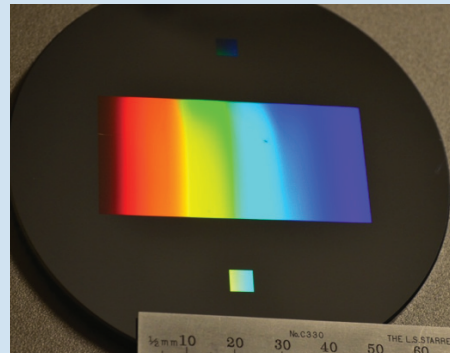
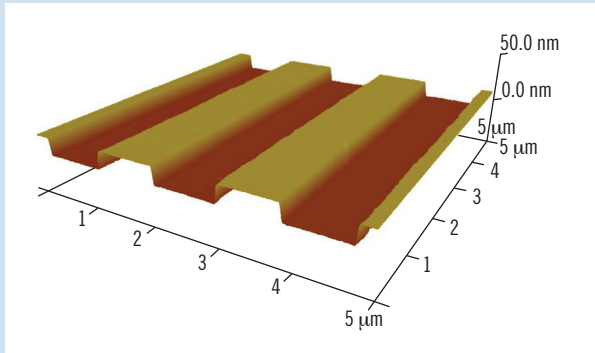

The grating efficiency must be optimized for the selected working range of photon energy, outside of which it can drop very quickly. This means carefully designed groove depths or blaze angles. Shallower grooves or smaller blaze angles are required for higher photon energy and vice versa. This figure shows a 600 lines/mm ion-etched grating (top) with approximately 20 nm deep grooves, demonstrating the very large asymmetry between period and groove depth. The wavelength dependence of diffraction efficiency in first order for lamellar (left) and blazed (right) gratings with 300 lines/mm optimized for operation between 250 eV and 1000 eV in a monochromator geometry with constant magnification. This shows how critical groove parameters are on ultimate performance. Differences in groove depth for a lamellar grating of a nm can be significant.

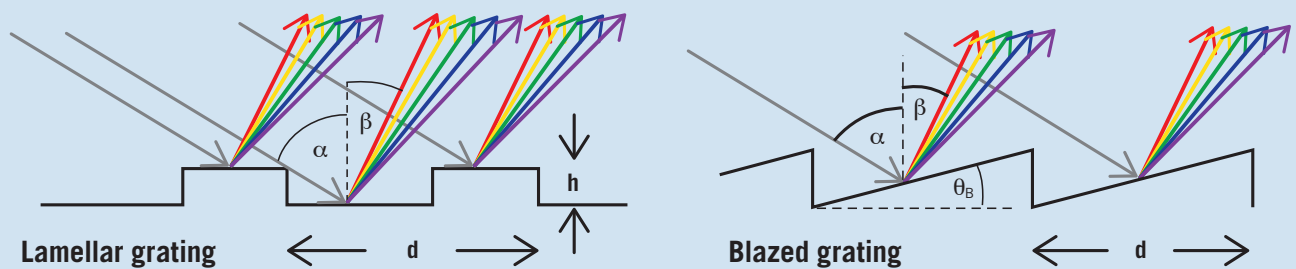

Thanks to the periodicity of the structure (period =  $d$ ), gratings diffract light of different wavelengths in different directions. Soft X-rays of a specific wavelength incident at an angle  $\alpha$  are diffracted at an angle  $\beta$  that provides a difference in light traveled path of one or a multiple of a wavelength from groove to groove. For lamellar (rectangular) grooves, the efficiency is maximized when there is constructive interference between the tops and bottoms of the grooves (groove depth =  $h$ ). Gratings may alternatively have a sawtooth groove profile (blazed). Blazed gratings have maximum efficiency when the incoming light and the diffracted light have the same angle with respect to the inclined facet (blaze angle =  $\theta_B$ ), which acts as if it were reflecting the diffracted beam. This is called the blaze condition. Blazed gratings used for soft X-rays have about twice the efficiency of an equivalent lamellar grating.

- Lack of precision in the groove placement (mostly in the case of a variable-line-space [VLS] grating) limits high-resolution spectrometers and in some cases monochromators.
- The maximum length of available gratings limits their usefulness in monochromators at FEL facilities and reduces the collection angle in spectrographs and monochromators.
- The lack of shallow blaze angle gratings prevents the use of grating-based monochromators in the intermediate energy region between soft and hard X-rays. It also creates difficulties in the use of gratings at high-power FEL sources.
- Multilayer grating technology that can dramatically increase the throughput of a monochromator is not well established. It potentially is a route to very high resolution.
- High groove density is not readily available. In some cases, this is the only way to reach the desired spectral resolution for spectrographs.
- Arbitrary groove patterns cannot be written at present using conventional methodologies, and this limits the aberration correction that can be achieved in wide-aperture spectrographs.
- Reflection gratings always have a low angular aperture, due to the small critical angles of total external reflection in the soft X-ray region. Gratings with much larger angular aperture are required for techniques such as X-ray fluorescence analysis and low-medium energy resolution RIXS.
- Only a very limited number of vendors around the world can make gratings to the specifications needed for synchrotron and FEL applications. This has resulted in lengthening delivery times and a general difficulty procuring gratings to the exacting specifications needed.

Several scientific areas suffer because of these deficiencies. One area in particular is inelastic X-ray scattering, a powerful new tool in the study of the electronic structure of a range of areas, from catalysis to condensed matter physics; this is described later in this chapter's *Impact* section [1]. This technique requires spectral analysis of photons emitted by a sample irradiated by soft X-rays. The emitted spectrum is collected with a spectrograph that disperses and focuses the X-rays onto a detector. To date, the progress of RIXS has been severely restricted by the types of gratings available to the optical designer, for example in terms of the required combination of line density, blaze angle, and size. In addition, the resolution achieved in RIXS is limited by practical barriers, such as the maximum allowable size of a spectrograph (that is sometimes rotated about the sample), and the maximum line density commensurate with reasonable efficiency. To overcome these limitations, new types of gratings are required that can achieve very high resolution while maintaining efficiency. One example is a new type of ultradense grating that can operate in high spectral order. RIXS today is performed at a resolution of typically 150 meV, but to access the soft excitations that drive many processes in complex materials, a resolution of around 10 meV is required, corresponding to a resolving power of  $10^5$  at 1 keV. Such advances will require major developments in the design and fabrication of gratings.

To illustrate the range of projects that require gratings that are at or beyond the state of the art, we have highlighted here a few specific examples.

Very-high-resolution RIXS spectrometers are planned or under construction at ALS, the Linac Coherent Light Source (LCLS-II) and at NSLS-II. These projects require a beamline and a spectrometer each aiming for 10 meV resolution at 1000 eV, i.e., more than 1 order of magnitude greater resolving power than has presently been achieved. High-density gratings (2,000–3,000 lines/mm) are required. The large size of the systems required for ultra-high resolution, from source to dispersion plane and from sample to detector, leads to very tight slope-error tolerances on all optical components. The most critical components are the monochromator gratings, which need to absorb many watts of power at high power density and at the same time retain a very small slope error (0.05  $\mu$ rad rms). These gratings are significantly beyond what has yet been achieved. Both the monochromator and the spectrometer require varied line-space gratings that implement the optical designer's groove-density prescriptions accurately. This is already a challenge at a resolving power of  $10^4$ , and so again, the specification required here is well beyond what has been achieved before. The scattering cross section for inelastic soft X-ray scattering is very small; a small bandwidth has to be used, and so achieving high efficiency is critical for performing practical

experiments. This requires the use of blazed gratings, again compounding the complexity of the gratings required. These high-density blazed gratings can take months to rule, accounting for the very high cost and limited world capacity in this highly specialized area. From a theoretical perspective, these reflection gratings, although demanding, are none ideal, and in principle much better performance can be obtained from volume multilayer gratings, when that technology has matured.

A second area requiring advances in soft X-ray grating technology is in angle-resolved photoemission spectroscopy (ARPES). This technique is one of the most important and productive techniques used in condensed matter physics and has become the primary technique to explore the electronic structures of many new exotic materials such as high-temperature superconductors, graphene, and topological insulators. Photons at energies between 20 eV and 200 eV excite valence electrons and probe the electronic structure of materials in the solid state, nowadays with exquisite energy and momentum resolution. The Microscopic and Electronic STRucture Observatory (MAESTRO) project at ALS is under construction and is designed to give a resolving power of around 30,000 using a state-of-the-art VLS monochromator. Slope error and groove-placement error specifications are at or beyond the current state of the art. Limitations in manufacturing capability have meant that in this project, none-optimum lamellar gratings had to be used, limiting the efficiency of the beamline.

A third area is in coherent imaging and scattering. The NSLS-II coherent soft X-ray (CSX) and ALS coherent scattering and microscopy (COSMIC) beamline projects both make use of varied line-space gratings (VLSs) for coherent soft-X-ray science. Spectral resolution requirements are modest but throughput and brightness preservation are paramount, leading to new requirement for very coarse gratings. The required high-efficiency coarse blazed gratings are beyond current capabilities and so much-lower-efficiency lamellar gratings have been used instead. This compromises the performance of the beamlines and impacts the type of science that will be possible.

Finally, for high-energy resolution at FEL facilities, gratings are needed to narrow the native bandwidth from the X-ray laser. Gratings that operate for this application have some unique and demanding features. Monochromators have to operate close to the time-bandwidth limit in the diffraction limited coherent beam and hence are required to make only negligible contributions to phase front errors. Diffraction gratings are also required for soft X-ray self-seeding, in which the FEL bandwidth is restricted by a monochromator in line with the FEL undulators. In all applications of gratings at FEL facilities, the technical requirements reach new levels of stringency. Surface deformation tolerances, for example, are typically a few nm. Gratings must operate at extreme grazing angles and they must have a blazed profile to avoid single-shot ablation. In this new field with new challenges, there is currently no domestic development of grating fabrication techniques to meet these needs. Gratings as long as 500 mm will be required because of the need to operate at extreme grazing incidence and at large source-to-grating distances, with blaze angles well below 1°. Coatings of unusual materials will be required for resilience against shot damage. At the high repetition rates envisaged for future FEL sources, the thermal power density is extreme, requiring silicon gratings operating at cryogenic temperatures.

## R&D Directions for the Future

We have outlined a set of key issues that need to be addressed with urgency. Here we offer some suggestions for R&D directions that would have immediate impact on these issues and offer cost-effective solutions.

- **Lack of precision in the groove placement (mostly in the case of a VLS grating) limits high-resolution spectrometers and in some cases monochromators.** We expect that developments will continue in Europe and Japan to extend existing ruling technology to new levels of precision. For example, the Institute for Nanometer Optics within the Helmholtz-Zentrum Berlin (HZB) is constructing a new ruling engine that will initially be used for ruling low-resolution X-ray free electron laser (XFEL) gratings of up to 500 mm in length for gratings with line densities of 50-100 lines/mm. The same machine will be capable of ruling high-resolution gratings up to 5,000 lines/mm. However, although developments of traditional ruling technology can be made, the basic technology is limited by its mechanical nature, making it slow, and ultimately limited in precision. High-line-density gratings can take weeks or even months to rule, limiting availability and increasing cost. For the next generation of grating production, we need a technology that can write arbitrary patterns and is able to write orders-of-magnitude faster than conventional ruling, with nm precision over large areas.

Several methods could be applied to next-generation grating writing. Here we highlight direct-write optical lithography (DWOL) and shaped-beam electron beam lithography. DWOL is widely used in the semiconductor industry, in particular for making lithographic masks. A blank coated with photoresist is exposed to a focused laser beam. The writing is performed by scanning of the blank under the laser spot and modulating laser intensity. The interferometer-controlled scanning stage provides high position accuracy of pattern features over a large area, in principle to the nm level of precision. This makes the technique very promising for recording X-ray diffraction gratings. The DWOL technique has potentially great advantages over traditional diamond ruling. First, the state-of-the-art DWOL tools provide a very high speed of writing, which mitigates greatly any environment stability issues and makes the process cheaper and more productive. Secondly, a DWOL system is very flexible and can write a pattern of any complexity, such as a reflective zone plate. One recent commercial extension of the technique has been the use of a writing head with thousands of beams, each individually modulated. This vastly speeds up writing over single-beam techniques. Initial explorations of the technique have been successful, but to take this further, a partnership with industry must fully develop the technique.

The Nanoruler is a scanning lithography tool, developed at MIT, that has been commercialized. This is a type of DWOL machine [5], but instead of a microfocused writing beam (or array of beams), the beam consists of a small interference pattern. The machine essentially stitches many of these small patterns together to yield a large grating pattern. Due to its parallel writing process, the machine can pattern very large areas in a short time. The commercialized version has patterned gratings up to 1 m x 0.45 m in scale, for high-power laser applications. In principle, the technique can be adapted to write variable groove-density gratings, but alteration of the interference pattern period as a function of position is a significant complication. This and other adaptations are required to make the technique viable for X-ray grating production and should be carried out in collaboration with industry.

A development in electron beam lithography (EBL) is the use of variable-shaped beams (VSBs), in which the beam shape is dynamically changed as the beam or stage is scanned. This allows a huge increase in writing speed, when high resolution and placement accuracy is needed for structures (such as grating lines) that are relatively large. VSB-EBL technology is becoming well used in high-resolution mask writing for semiconductor applications. Its use in grating manufacture presents unique challenges that should be addressed in a grating R&D program.

- **The lack of shallow blaze angle gratings prevents the use of grating-based monochromators in the intermediate energy region between soft and hard X-rays. It also creates difficulties in the use of gratings at high-power FEL sources.** Shallow blazed gratings (less than  $1^\circ$ ) have been produced by ruling into gold with a relatively high angle, then transferring into a substrate at low angle using differential ion etching. For example, this approach will be employed on gratings produced by the new ruling engine at HZB and is required for the large gratings to be used at XFEL. This is a solution that will have low capacity, however, due to the time taken to rule, and the uniqueness of the machine. In addition, as the facet angle on blazed gratings decreases, the flatness

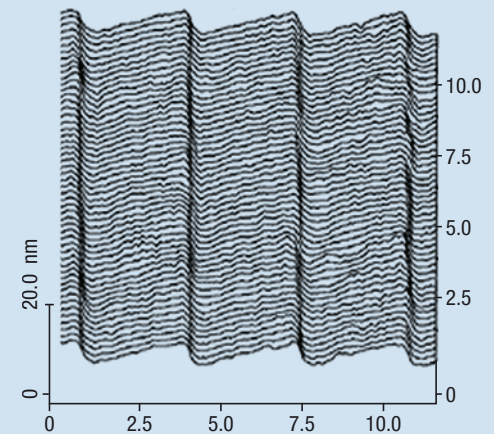

Shallow blazed gratings have been produced by differential ion etching after ruling. The initial grating is mechanically ruled in gold. The pattern is transferred to the silicon substrate by ion-beam etching and the difference in etch rate between Au and Si gives a shallower blaze. In this example, the blaze angle is reduced from  $2.8^\circ$  to  $0.1^\circ$ . [4]

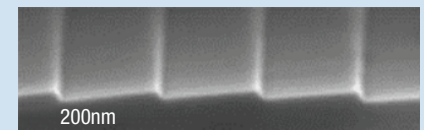

An alternative strategy is to etch into a crystalline silicon substrate, off-cut from the [111] lattice planes. Anisotropic etching in KOH under optimum conditions results in etching of the [111] planes up to 1,000 times slower than other crystalline planes. The patterned surface of an inclined [111] crystalline substrate is therefore etched so as to reveal the [111] planes. Close-to-atomic smoothness of the facets can be obtained, resulting in high efficiency and low scattered light. The figure shows an SEM image of a 5,000 lines/mm grating produced in this way [2].

Asymmetrically cut single-crystal silicon substrates can be polished, patterned, and etched along the crystal planes to produce very smooth facets, resulting in blazed gratings with blaze angles set by the angle of the cut surface with respect to the crystal lattice orientation. These blazed gratings can be coated with multilayers to generate structures with high diffraction efficiency in higher diffracted orders, resulting in several times higher dispersion than available from conventionally ruled gratings. This technique opens the possibility of very-high-resolution optical systems of manageable size. The top figure below shows an AFM image of silicon blazed gratings with a groove density of 10,000 lines/mm fabricated by this method. After Mo-Si multilayer coating (shown below center), efficiencies are measured close to the computed value, which can be as high as 44%, depending on the X-ray wavelength and the multilayer material [2].

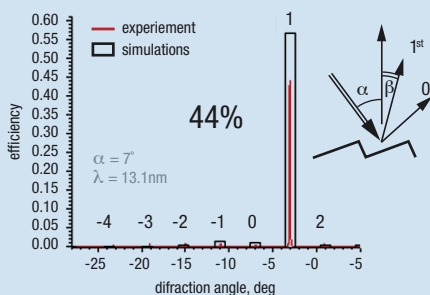
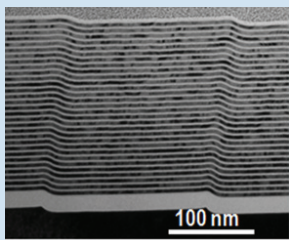
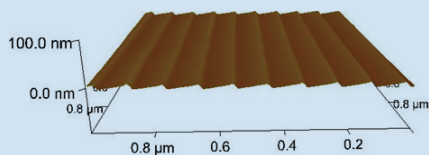

of the facet has to increase in order to take full advantage of the high blazed diffraction efficiency. This is a challenge for ion-etching techniques. Blazed gratings that have facets with near-atomic perfection can be produced by anisotropic etching of offcut crystalline silicon substrates. The surface is offcut from the [111] planes by the required blaze angle, the surface is nitrided and patterned by normal lithography, and the substrate is then etched in KOH to reveal the [111] inclined planes. This technique has been shown to produce facets close to atomically flat. It has been used to produce small area gratings with 1° blaze angle, but practical use will require significant R&D to show that etching large areas is possible, that blaze angles down to 0.2° can be produced, and that the yield is high enough for commercial manufacture. The benefit will be the availability of ultralow-scatter gratings that can be used at extreme grazing incidence for FEL optics or to access the intermediate energy X-ray range (1.5–3 keV).

- Multilayer grating technology that can dramatically increase the throughput of a monochromator is not well established. It is a potential route to very high resolution.** Multilayer-coated blazed gratings (MBGs) are a promising solution to the problem of achieving ultrahigh spectral resolution. The present approach to this problem, for example in RIXS, is to use reflection gratings with extremely high line density combined with very-large-size optical systems. An unfortunate consequence of this is that the diffraction efficiency is very low, and practical resolution is substantially limited by this low throughput. An alternative is to use dense MBGs in high order. In this approach, a multilayer is deposited on the facets of an anisotropically etched grating, forming a 3-D diffracting structure. Theoretical study has shown that high-density, high-order MBGs can achieve very high efficiency, unlike grazing incidence reflection gratings under the same conditions. A recent practical demonstration has shown an efficiency of over 40% at 100 eV for a 5,000 lines/mm grating in 3rd order. Several technological hurdles must be surmounted before this type of grating can be routinely used in the soft X-ray energy range. The main issues are connected with the difficulty of coating a faceted surface with small period multilayers. Normally in multilayer deposition, one relies on the surface energy of a deposited atom to be sufficient for it to diffuse to a missing atom defect in the surface so that roughness growth is minimized. When depositing on a faceted substrate however, this energy has to be limited by use of directional low-energy ion-deposition techniques, so that the sawtooth shape of the facets can be replicated layer to layer. There is, therefore, a balance between smoothing and the fidelity of replication. Although MBGs have potentially revolutionary properties, extension of this technique into the soft X-ray region requires a much better understanding of all of these processes.
- High-groove-density blazed gratings are not readily available. In some cases, this is the only way to reach the desired spectral resolution, especially for spectrographs.** The technique developments described above promise an improved capability to rule very fine gratings. Ruling engines can rule up to about 5,000 lines/mm, but are slow, limiting the availability and resulting in very high cost. For example, DWOL promises high write speed with very high resolution, allowing rapid and lower-cost production of high-density gratings. Anisotropic etching of offcut Si surfaces is one very promising route to highly efficient blazed gratings, but must be proved in the context

of real large-area optics. Multilayer coated gratings can be designed to operate in higher order, as described above, effectively increasing the line density, while maintaining high efficiency.

- Arbitrary groove patterns cannot be written at present using conventional methodologies, and this limits the aberration correction that can be achieved in wide-aperture spectrographs.** The techniques of DWOL in single- and multiple-beam geometries and VSB-EBL, as described above, all have the ability to write arbitrary patterns to very high precision. They are new techniques, not presently adapted to large area X-ray grating production, that need to be modified and adapted to work in this new area. Developments in local area scanning interference lithography also have the potential for arbitrary pattern generation. It has the advantage of extremely fast writing, but with somewhat less flexibility than the other approaches described.
- Reflection gratings always have a low angular aperture, due to the small critical angles of total external reflection in the soft X-ray region. Gratings with much larger angular aperture are required for techniques such as X-ray fluorescence analysis and low- to medium-energy resolution RIX.** Transmission gratings seem to offer advantages over reflection gratings in some applications, due to their high collection aperture. However, they have traditionally suffered from low diffraction efficiency and from the inability to blaze them efficiently in higher orders. A new blazed transmission grating design based on grazing incidence onto nanometer-smooth, ultra-high-aspect-ratio grating bar sidewalls — the so-called critical-angle transmission (CAT) — combines the advantages of reflection and transmission gratings and could potentially be used in relatively low-spectral-resolution experiments that require high throughput. CAT gratings are currently being developed at the MIT Kavli Institute's Space Nanotechnology Laboratory for space-based applications supported by NASA. Up to 10<sup>th</sup>-order diffraction has been demonstrated, and it is expected that with further development, efficiencies up to 50% could be achieved in the soft X-ray energy range. The challenge is to develop gratings that can be used in large angular aperture geometries, rather than the large-area geometry of X-ray telescopes.
- A very limited number of vendors around the world can make gratings to the specifications needed for synchrotron and FEL applications. This has resulted in lengthening delivery times and a general difficulty procuring gratings to the exacting specifications needed.** Currently, only three manufacturers worldwide supply gratings to the synchrotron and FEL community, and none of these are in the United States. The limited number of vendors and the complexity of presently used techniques create a supply problem leading to long delivery times and high costs. It also severely limits the quantity and type of R&D that can be pursued with vendors. This latter point is extremely important. As outlined above, there are plenty of directions to pursue in X-ray grating manufacture, some of which could potentially be revolutionary. To enable these advances, we need to encourage existing U.S. vendors to diversify into X-ray grating R&D and manufacture. Due to the small size of the market, compared to the huge market for traditional optical gratings and gratings used in telecommunications, this diversification should be catalyzed by joint research programs between the national laboratories and industry to encourage the emergence of this new domestic production capability.

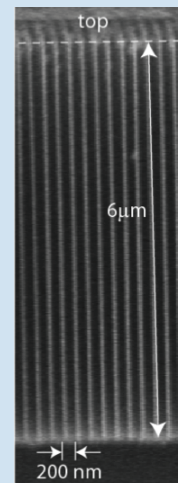
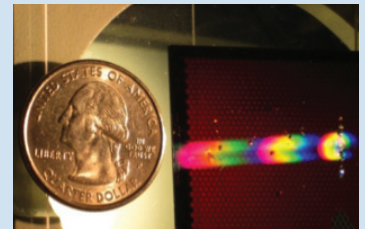
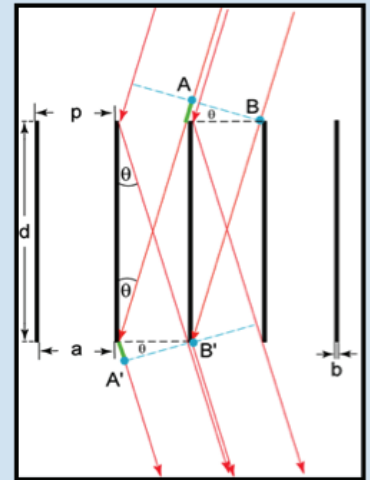

CAT (critical-angle transmission) gratings combine advantages of transmission gratings (relaxed figure, small size, large acceptance) with the high/broadband efficiency of blazed reflection gratings.

Blazing is achieved via reflection from grating bar sidewalls at grazing angles below the critical angle for total external reflection.

Efficient blazing enables use of higher orders for increased resolving power [3].



## Impact

### THE POTENTIAL OF INELASTIC X-RAY SCATTERING

Resonant inelastic soft X-ray scattering spectroscopy (RIXS) fills in a critical gap in current research capabilities to directly observe and manipulate nanoscale quantum many-body states [1]. When incident X-rays are scattered by materials, the transferred energy and momentum from photons to a material reveal the dispersion of elementary excitations that bear the signature of correlations among multiple electrons. With the unique sensitivity of soft X-rays

to charge, spin, and orbital degrees of freedom, and the accessibility to various core levels and intermediate states through tuning incident photon energies and polarizations, RIXS has become a promising technique to explore local electronic correlations where intriguing emergent material properties such as high-temperature superconductivity, multiferroicity, colossal magnetoresistance, and topological states are manifest. Besides using X-rays to directly probe charge and orbital excitations, the higher sensitivity to spin compared to neutrons opens the possibility of studying spin excitations in systems that are either too small (e.g., nanoparticles) or too thin (e.g., thin films and heterostructures) for neutron measurements. These systems often exhibit new functionalities at surfaces and interfaces due to enhanced quantum confinement and/or proximity effects. The technical challenge is to improve energy resolution from the 150 meV typical of today's instruments to a total energy resolution of the monochromator and spectrograph of 10 meV. Many of the important excitations that drive exotic emergent behavior have a very low energy and are masked by the relatively poor spectral resolution of the instruments we have today. Improving resolution by more than an order of magnitude would have enormous impact on the field. It is, however, an enormous challenge, and one that primarily depends on advances in grating technology as previously described.

### Direct-Write Optical Lithography

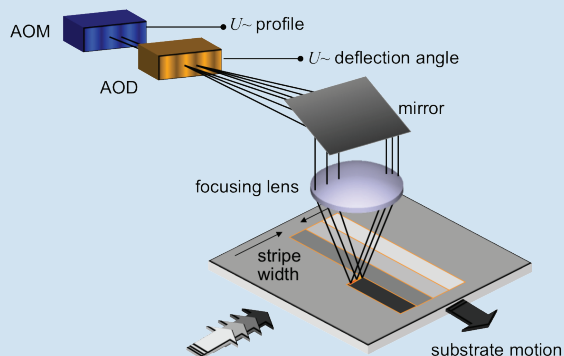

Direct-write optical lithography employs a deep UV laser focused with a high NA lens, to pattern photoresist on a substrate scanned beneath the beam. The scanning system typically uses a magnetic linear motor-driven air-bearing stage under interferometer control (e.g., Heidelberg DWL, above). A version of this type of system uses a scanning small spot interference pattern to increase throughput (MIT Nanoruler). An extension of this techniques uses an array of diffraction-limited lenslets employed to effectively multiplex the process, speeding up the writing (e.g., LumArray Inc., below). These types of systems have a positional accuracy and resolution suitable for most X-ray gratings, and a write speed of around 1 mm<sup>2</sup>/sec, potentially enabling rapid production of gratings. With developments to address the specific needs of X-ray gratings, these techniques may be a useful new tool for grating manufacture.

### ULTRAFAST DYNAMICS AND HIGH-RESOLUTION SPECTROSCOPY AT FEL FACILITIES

FELs are X-ray sources of unprecedented peak brightness, 10 orders of magnitude brighter than current synchrotron sources. They are revolutionary sources for the study of ultrafast processes in many branches of physics and chemistry. After the groundbreaking early successes of LCLS at SLAC, a new facility, LCLS-II, is under construction and a high-repetition-rate soft X-ray source, the Next Generation Light Source (NGLS), is under development at Berkeley Lab. Diffraction gratings are central to modern soft X-ray FELs. They provide a means to self-seed the FEL process through use of a tunable monochromator that acts as a narrow bandpass filter in the FEL beam, prior to saturation. This filter locks the subsequent lasing to the required wavelength and increases the peak brightness. Gratings will be implemented in monochromators in the full-power FEL beam as part of high-resolution spectroscopy experiments, and they are at the heart of soft X-ray spectrom-

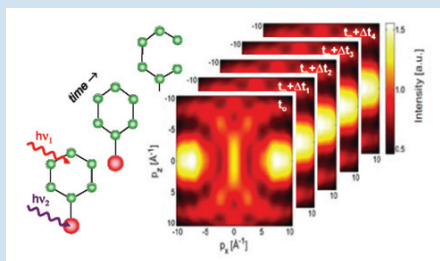
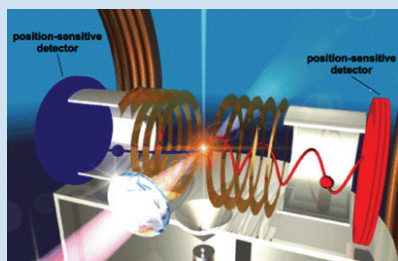

Time-resolved pump-probe experiments at FELs are set to revolutionize our understanding of chemical reactions, giving us the ability to follow electron dynamics on the femtosecond timescale. A visible-IR pump pulse will initiate a charge transfer process, and the following electronic rearrangement will be probed by a soft X-ray photon. By tuning the soft X-ray energy through an absorption edge, or by observing fluorescence or a RIXS process, the measurement can be designed to probe the defined chemical. Such types of spectroscopy depend critically on gratings to monochromatize and analyze soft X-rays.

eters. With the soft X-ray self-seeding implementation, we will have access to a single mode, fully diffraction-limited soft X-ray source with unprecedented brightness. It will enable the study of chemical reactions at the fundamental timescale of electron motion, for example the photocatalytic splitting of water, photosynthesis, and in a multitude of solar energy conversion processes. The FEL also opens the door for understanding and controlling emergent behavior in complex materials again with the ability to access the fundamental timescale set by electron motion. This should open a new world of complex materials that could play a key role in the development of new 21<sup>st</sup> century technologies.

## References

1. Synchrotron Radiation News 25(40, (issue dedicated to inelastic scattering), 2012.
2. D.L. Voronov et al., *Ultra-high efficiency multilayer blazed gratings through deposition kinetic control*, Opt. Lett. 37, 1628-1630, 2012.
3. R.K. Heilmann et al., *Diffraction efficiency of 200 nm period critical-angle transmission gratings in the soft X-ray and extreme ultraviolet wavelength bands*, Appl. Opt. 50, 1364-1373, 2011.
4. K.F. Heidemann, B. Nelles, and R. Lenke, Proceedings 9th Int. Conf. on Synch. Rad. Instrum. AIP Conf. Proc. 879, 485-488, 2007.
5. C.G. Chen et al., *Nanometer-accurate grating fabrication with scanning beam interference lithography*, SPIE 4936, 126-134, 2002.
6. P. Kuiper et al., *Resonant X-ray Raman spectra of Cu dd excitations in Sr<sub>2</sub>CuO<sub>2</sub>Cl<sub>2</sub>*, Phys. Rev. Lett. 80, 5204, 1998.
7. M. Guarise et al., *Measurement of magnetic excitations in the two-dimensional antiferromagnetic Sr<sub>2</sub>CuO<sub>2</sub>Cl<sub>2</sub> insulator using resonant x-ray scattering: evidence for extended interactions*. Phys. Rev. Lett. 105, 157006, 2010.

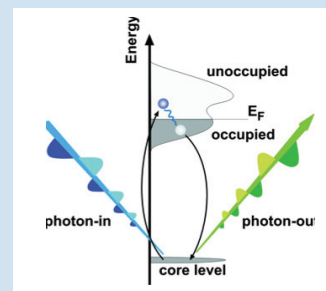

Schematic showing the RIXS process. An incident photon promotes a core electron into an unoccupied state, while the created core-hole is filled by a valence electron, leading to the scattered X-rays. The energy and momentum transferred in this process reveal the dispersion of the elementary excitation.

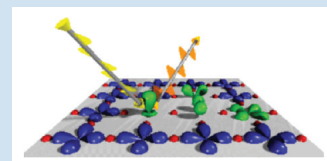

Schematic showing the RIXS process applied to the study of Sr<sub>2</sub>CuO<sub>2</sub>Cl<sub>2</sub> (top) showing the orbitals that can be interrogated by defining the scattering geometry and the experimentally measured Cu L<sub>3</sub> spectrum as a function of momentum transfer (lower) [6,7].

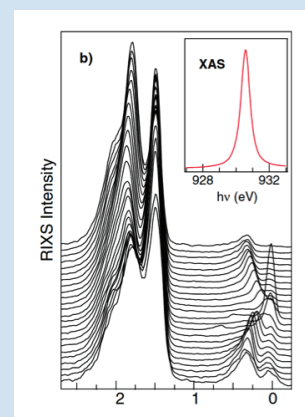

# X-ray Mirrors

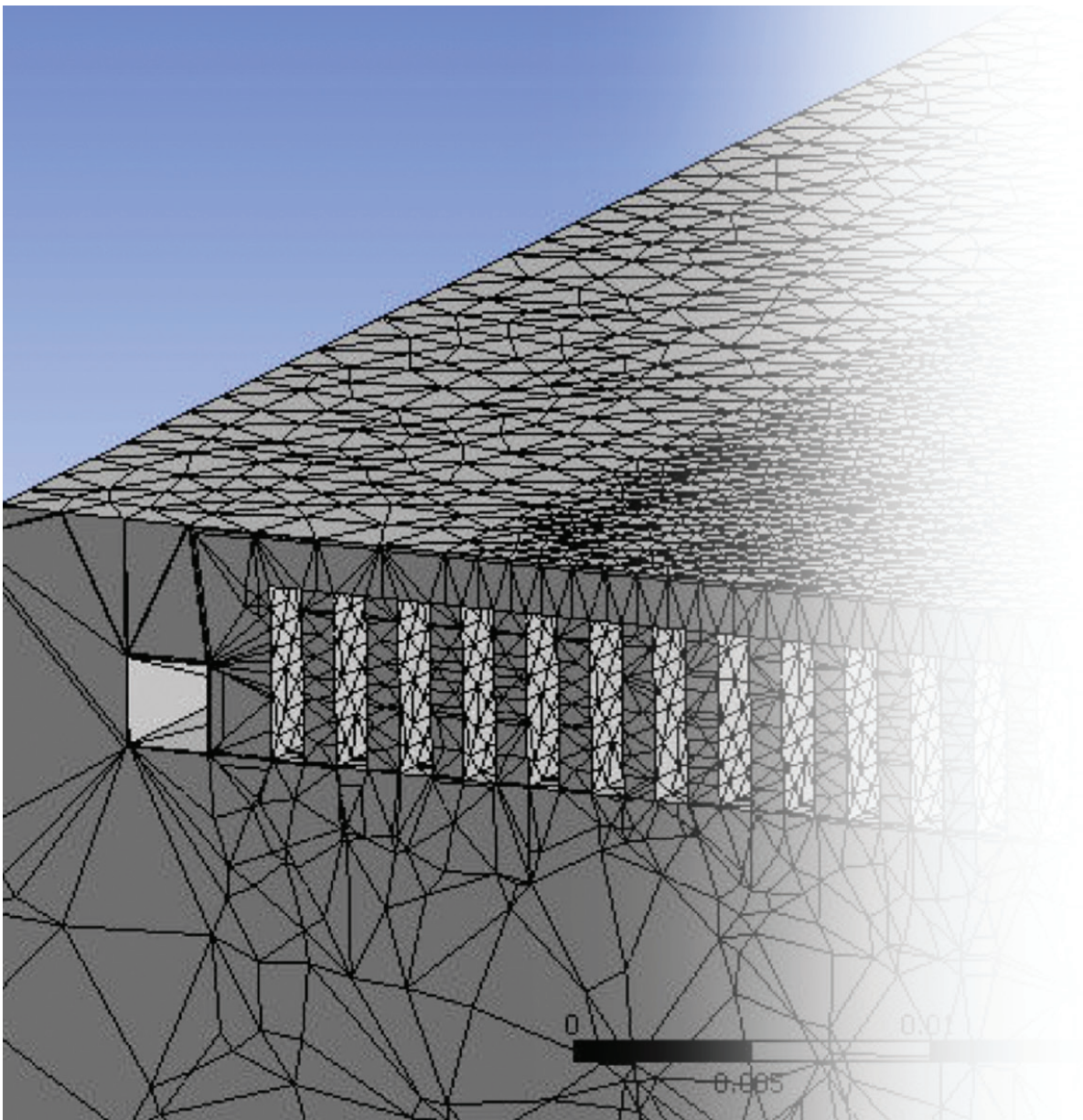

## Summary

X-ray mirrors are standard components for collimating, focusing, and low-pass filtering at all Department of Energy X-ray light sources. Demands on the quality of the figure and finish of mirrors are severe for third-generation synchrotron sources; yet new diffraction-limited X-ray sources, whether free-electron laser (FEL) or storage ring-based, will place even more extraordinary demands on beamline optics. This is due to both the uniqueness of experimental requirements and the paramount importance of preserving the ideal beam characteristics as the beam is manipulated and transported to the experimental station. Grazing incidence mirrors provide an absolutely essential, achromatic means to concentrate the diverging beam radiated by the source into a small spot for sample illumination. Alternative focusing technologies suffer chromatic aberration, which reduces the practical band pass by orders of magnitude.

### Working Group Chairs:

L. Assoufid (ANL)  
T. Rabedeau (SLAC)

### List of contributors in alphabetical order:

D. Bajuk (Zygo)  
R. Barrett (ESRF)  
S. Boutet (SLAC)  
D. Cocco (SLAC)  
P. Eng (University of Chicago)  
S. Goto (Spring-8)  
J. Hadju (Uppsala University)  
M. Idir (BNL), G. Ice (ORNL)  
J. Krzywinski (SLAC)  
J. Metz (InSync)  
J. Miao (UCLA),  
D. Mills (ANL)  
S. Moeller (SLAC)  
A. Sandy (ANL)  
T. Tonnessen (InSync)  
M. Tricard (Zygo)  
T. Warwick (LBNL)  
G. Williams (SLAC)  
K. Yamauchi (Osaka University,  
Japan)  
V. Yashchuk (LBNL)

Many of the unique scientific opportunities afforded by diffraction-limited X-ray sources — such as single-molecule coherent X-ray imaging, nanodiffraction, nanoprobe spectroscopy, etc. — require maximum intensity in the focus and/or are extremely sensitive to wavefront distortion. Accordingly, these applications require mirrors with <math><50\text{-nrad}</math> rms slope errors (ideally  $\sim 25\text{ nrad rms}$ ) and  $\leq 0.5\text{-nm}$  rms figure height errors (ideally  $\sim 0.3\text{-nm rms}$ ) for surface error wavelengths ranging from a few millimeters to the full optical aperture of the optic, which can approach 1 m for hard X-ray optics. Shorter-wavelength surface errors (roughness) should be  $<0.1\text{-nm rms}$  (ideally  $\sim 0.05\text{-nm rms}$ ) for error wavelengths down to the X-ray extinction length with somewhat larger surface errors tolerable at even shorter wavelengths. These error specifications represent the current state of the art for short-, flat-, or low-curvature mirrors. This performance envelope, however, must be extended to 1-m-class mirrors and figured optics with high curvature. To achieve this performance improvement requires research and development as follows, in priority order.

### RECOMMENDATIONS

1. **Improve fabrication process-compatible metrology.** To make real progress and reduce cost in the fabrication of high-perfection mirrors, vendors require metrology instruments capable of rapid (i.e.,  $\leq$ hour/ measurement) but highly accurate surface morphology characterization for iterative surface figure refinement. Advancing the state of the art of such tools for integration into the fabrication feedback loop is essential.
2. **(a) Reduce the thermal deformation of mirrors by applying LN<sub>2</sub> cooling technology to mirror optics.** Several engineering challenges require further investigation to implement liquid nitrogen mirrors successfully: (1) management of mirror strain resulting from large differential thermal contraction, (2) mitigation strategies for mirror surface contamination owing to the getter character of the cold optical surface, and (3) at-temperature metrology.

- (b) **Expand research into the damage mechanisms, damage onset thresholds, and damage-mitigation strategies for both mirror coatings and substrates.** Radiation damage represents a significant concern, particularly as escalating performance places higher-value optics at risk. The introduction of FELs presents new mechanisms for radiation damage and these mechanisms must be thoroughly explored.

3. **Explore the requirement for diffraction-limited grazing incidence mirror performance to avoid aperture edge effects.** Novel apodizing optics may provide alternative means to avoid aperture effects with modest-size mirrors. This requires development of practical implementations that do not compromise the achromatic advantages of grazing incidence reflection optics nor introduce other deleterious artifacts.

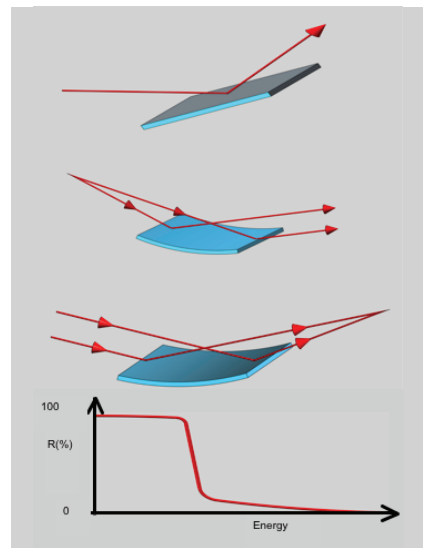
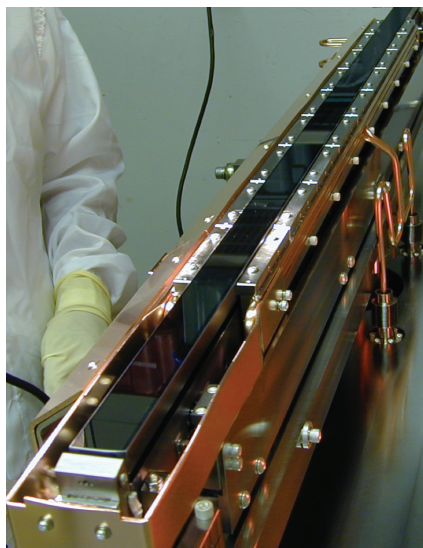

**Left:** An X-ray mirror ready for installation in a synchrotron beamline. Mirrors must be very long in the direction of the X-ray beam due to the low angle of incidence required to achieve total external reflection. **Right:** Schematic of some of the functions mirrors serve as X-ray optical components. From top: deflection, collimating, focusing, low pass filter. Because of their variety of uses, X-ray mirrors are used in nearly all synchrotron and FEL beamlines.

## X-ray Mirrors

For X-rays, the index of refraction in a material is close to, but slightly less than 1 and is written as a complex number,  $n$ , given by  $n=1-\delta-i\beta$ . with  $\delta = \lambda^2\rho r_0/2\pi$  where  $\lambda$  is the wavelength,  $\rho$  is the electron density, and  $r_0$  is the Thompson scattering length and  $\beta$ , the imaginary part of the refractive index, describes the decay of the intensity of a beam as it propagates in a material. Typical values for  $\delta$  are of order  $\sim 10^{-6}$  and so the index of refraction,  $n$ , for X-ray is less than unity by a few times  $10^{-6}$ , resulting in total external reflection for glancing angles below the critical angle,  $\theta_c$ . ( $=\sqrt{2\delta}$ ). Typically, the mirror is set at a fixed angle, resulting in an energy cutoff,  $E_c$ ; X-rays with energies below  $E_c$  are reflected and those above are not. In the lower figure, the reflectivity curves as a function of X-ray energy for three different materials — copper, gold, and silicon — are shown for fixed incident angle of 3 milliradians. The fine structure in the reflectivity below the cutoff energy stems from resonant absorption effects.

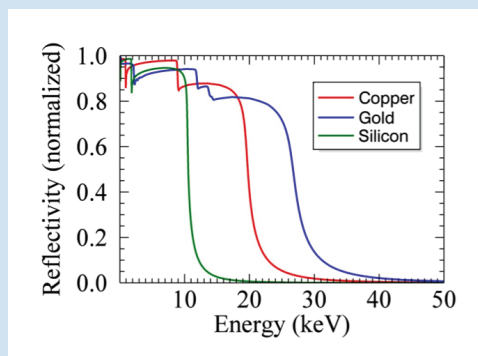
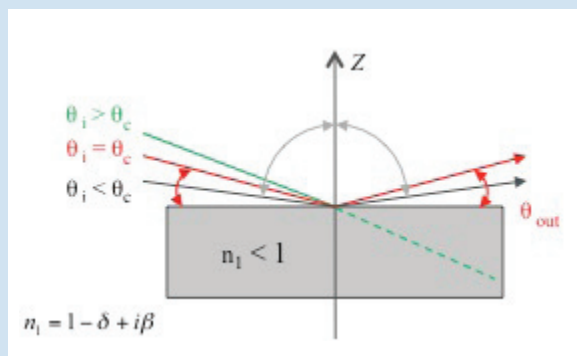

### 3-D Microdiffraction

The use of X-ray microbeams, or nanobeams, has had an enormous impact on a host of fields including high-pressure research, geosciences, environmental science, interfacial studies, energy technologies, photonics, chemical interactions, biomaterials, archaeology, and art history. Focusing with mirrors typically provides a longer working distance (than Fresnel zone plates, for instance) and is achromatic (that is, all wavelengths are focused at the same distance) and so is uniquely suitable for polychromatic or white-beam work. Polychromatic radiation has been very effectively used for three-dimensional (3-D) volumetric microdiffraction in polycrystalline materials. Using this technique, researchers have explored the origin of mechanical properties of polycrystalline materials, studied 3-D grain growth, and investigated strain-induced whisker growth in integrated circuits, to name a few. 3-D structural studies on these length scales (atomic scale to the mesoscale) provide value experimental data important for the validation of theory and simulations of real materials. [6]

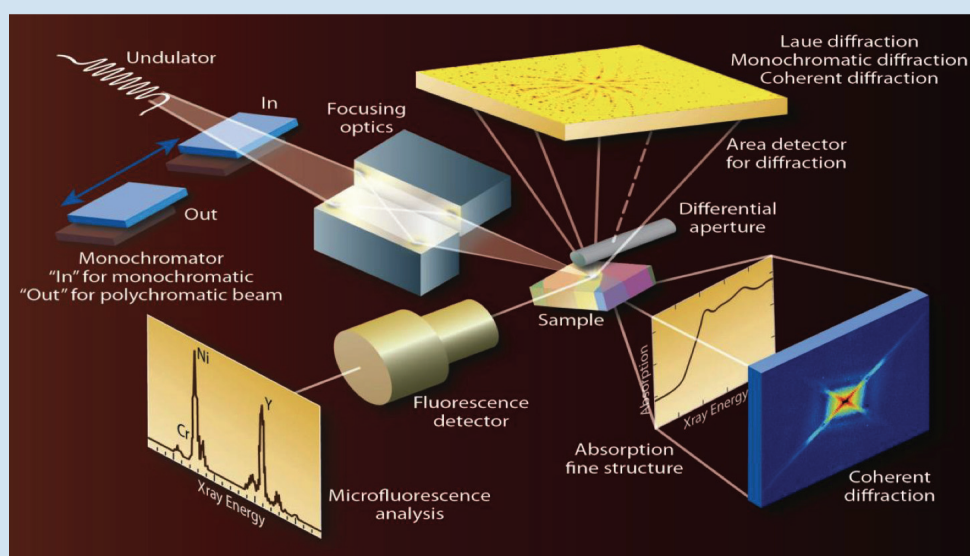

Experimental set up for 3-D microdiffraction. For polychromatic studies, the monochromator is removed and the polychromatic radiation is focused in two dimensions onto the sample with, in this case, a Montel X-ray mirror. Two-dimensional information (in the plane of the sample surface) is acquired by rastering the sample with respect to the X-ray beam. Information in the third dimension is obtained by moving a small beam stop (differential aperture) across the sample surface and observing which reflections are occulted. Through triangulation, the location of the voxel that is diffracting the X-ray can be determined. The Laue diffraction pattern is collected with an area detector. Other data, such as fluorescence analysis, can be collected as well.

Two 3-D volumetric measurements of grain orientation inside a rolled aluminum sample. The volume on the left is as received and on the right is the exact same volume, but after a brief anneal; the growth of grains is readily observable. The colors indicate the crystallographic orientation of each grain. The measurements were made at the Advanced Photon Source using the focused polychromatic X-ray system described above to obtain the crystallographic orientation of each small-volume element inside the displayed volume and submicron-size beams to obtain the spatial resolution. (Courtesy John Budai, Oak Ridge National Laboratory and Jon Tischler, Argonne/Advanced Photon Source.)

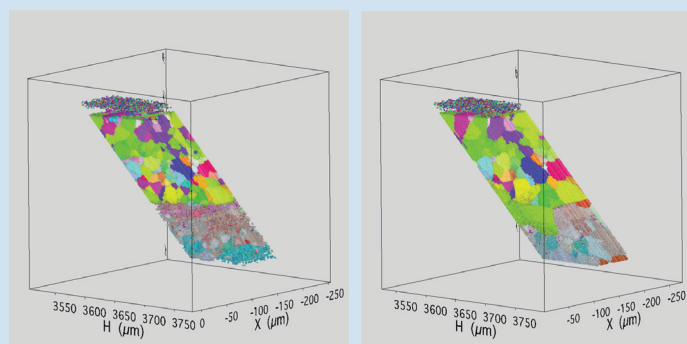

## Scope

### GRAZING INCIDENCE X-RAY MIRRORS

Grazing incidence mirrors are perhaps the most ubiquitous optical elements utilized in X-ray beam transport and manipulation. Like their visible-light brethren, X-ray mirrors specularly reflect photon beams achromatically (i.e., no spatial dispersion as a function of X-ray wavelength). Unlike visible-light mirrors, however, X-ray mirrors only reflect X-ray energies up to some maximum energy that is dependent on the mirror composition (or coating) and X-ray grazing incident angle (see *X-ray Mirrors* in this chapter). X-ray mirrors work at low grazing angles (typically a few milliradians), so even for small beam sizes, X-ray mirrors must be large (typically >20 cm) to collect a sizable fraction of the entire beam.

X-ray mirrors are used to remove unwanted higher-energy radiation or power from the reflected beam (low-pass filter), to displace the reflected beam axis from the incident beam axis to shield experimental stations from high-energy Bremsstrahlung radiation, or to direct the beam along different optical paths to associated experimental stations. Mirror surfaces can be figured during fabrication or through elastic deformation to collimate or focus the beam using parabolic or elliptical figures, respectively. In particular, focusing mirror optics provide an absolutely essential, achromatic means to concentrate the diverging beam radiated by the source into a small spot for sample illumination. The ability to focus to a small spot with mirrors is particularly important as focal spots approach nanometer dimensions, where chromatic aberration reduces the practical band pass for other focusing strategies by orders of magnitude. This fact is exploited in white-beam nanoprobe that can be used to probe the detailed mesoscale grain growth in materials that can then be used to validate models that predict the behavior of materials using in energy applications, for example.

Mirror performance must take into account all sources of error, including those originating from fabrication, support and elastic figuring, power deformation, and radiation damage. This section will not include mirror metrology nor adaptive optics, as those topics will be covered elsewhere in this report.

Mirror surface figure (or slope) errors often determine the minimum spot size that can be achieved with a focusing mirror. Slope errors find their origins in polishing imperfections during fabrication, mirror support or bender errors that result in undesired elastic strain of the mirror (see *Adaptive Optics* chapter), thermal deformations owing to deposited beam power, and radiation damage mechanisms that alter the reflecting surface morphology over time.

Slope errors can equivalently be regarded as surface height errors that introduce wavefront distortions in the reflected beam. As the wavelength of the surface height error decreases, the beam is diffusively scattered farther from the (specularly) reflected beam, resulting in less focal-spot intensity and a diffuse halo of intensity around the focus. Once the surface error wavelength is shorter than the X-ray extinction length (i.e., approximately  $10^5 \lambda$

with  $\lambda$  being the photon wavelength), the primary effect is the loss of reflected intensity as more photon energy is coupled into the mirror.

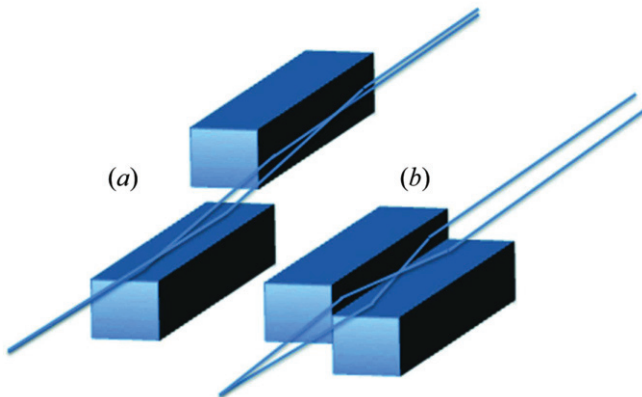

Focusing in two dimensions with mirrors is frequently done with two separate mirrors. (a): The usual KB geometry. (b): The Montel geometry, which has several advantages over the KB geometry but is much more difficult to fabricate.

Even today's synchrotron light sources have put high demands on mirror quality. Diffraction-limited X-ray sources, whether FEL or ring-based, place even more stringent demands on beamline optics owing both to the uniqueness of experimental requirements and the paramount importance of preserving the ideal beam characteristics as the beam is manipulated and transported to the experimental station.

To set the scale for tolerable mirror-surface errors in a diffraction-limited application, consider focusing 10-keV radiation from a 4-m insertion device on a 10-keV diffraction-limited source in the Gaussian approximation. Further assume an approximately 100-m-long beamline for which a perfect elliptically figured mirror would

produce a 100-nm full width half at maximum (FWHM) image in the diffraction limit (i.e., diffraction-limited image  $\text{FWHM} \approx \lambda R/D$  where  $\lambda$  is the photon wavelength,  $R$  is the distance between the mirror and the focus spot, and  $D$  is the transverse size of the accepted beam illuminating the mirror). Employing simple geometric scaling arguments indicates a 50-nrad rms slope error representative of today's state of the art over a few hundred millimeter mirror illuminated length would more than double the spot size relative to the diffraction limit.

A mirror surface height error  $\delta h$  introduces a wavefront error of  $\delta\phi \approx 2\delta h \sin\alpha/\lambda$ , where  $\alpha$  is the grazing incident angle of the beam on the mirror and  $\delta\phi$  is measured in waves. At the focus an rms wavefront error of  $\delta\phi_{\text{rms}}$  results in a decreased intensity  $I/I_0 = \exp[-(2\pi \delta\phi_{\text{rms}})^2]$ . The quantity  $I/I_0$  is called the Strehl ratio, where  $I$  and  $I_0$  are the peak intensities at the focus with and without aberration. The commonly accepted Maréchal criterion [1] for a "well-corrected" optical system requires a Strehl ratio greater than or equal to 0.8. For 10-keV photons reflected from a pair of mirrors operating at 3.0-mrad incident angle with uncorrelated errors, the maximum rms surface height error consistent with the Maréchal criterion is 1.1-nm rms. To put this into perspective: For a silicon mirror, this criterion is equivalent to controlling the surface height rms error to an approximately eight-atom layer spacing over hundreds of millimeters of mirror length. Coherence-sensitive measurements such as coherent X-ray imaging are extremely sensitive to wavefront distortion, requiring more aggressive specification than the Maréchal criterion. The soft X-ray beamline currently being designed for the Linac Coherent Light Source (LCLS)-II provides a real-world example. This beamline requires a Strehl ratio of 0.97 for out-of-focus operation of a four-mirror optical system operating at up to 2500 eV. This translates to a maximum allowed wavefront error of 0.028-wave rms or a 0.3-nm rms surface height error, just slightly more than two-atom layer spacing (rms) over the central 300 mm of the mirrors. As detailed below, this surface height error specification is essentially at the current state of the art for flat- or low-curvature mirrors, hence such mirrors are only available in extremely limited quantities at significant cost. Moreover, there is no domestic vendor for such optics.

## Issues

As noted above, there are four major limiting factors in mirror performance: (1) fabrication errors, (2) undesired strain owing to support and imperfect elastic figuring, (3) thermal deformation owing to deposited beam power, and (4) radiation and related damage mechanisms. In this section we will address the first and latter issues. The reader is referred to the *Adaptive Optics* chapter for correction of strain errors resulting from mirror support, and for elastic figuring of optics.

### MIRROR FABRICATION

Diffraction-limited mirrors require a surface morphology that deviates from the ideal figure by the equivalent of only a few atomic spacing. This is typically accomplished by applying a series of tools and processes that slowly remove excess material from a mirror surface until the desired shape (figure) and surface roughness (finish) is achieved. The process to achieve this requires highly specialized machinery and equipment that only a few optics manufacturers possess.

Over the past two decades, fabrication and polishing methods have significantly improved to diminish figure irregularity and surface roughness of X-ray mirrors by an order of magnitude.

Large flat mirrors up to 1.5 m are typically polished using large planetary chemical-mechanical polishing (CMP) machines. Frequent process metrology during fabrication (in-process metrology) is conducted to ensure that both the required slope and roughness figures are achieved. With this method, sub- $\mu$ rad slope error and surface roughness as low as 0.15-nm rms are achieved. Fabrication of 1-m-long flat mirrors with ~50-nrad rms slope error and 0.5-nm rms surface height error is believed to be feasible with improvements in process compatible metrology.

Kirkpatrick-Baez (KB) mirrors, where focusing is accomplished using two physically separated mirrors with one mirror for focusing each transverse dimension of the beam, is the most common type of focusing-mirror configuration. Focusing mirrors for microbeams can be elliptically figured either by bending or polishing. Bending a mirror is achieved by placing a mirror in a specialized fixture or by actuators. Achieving the desired figure precisely is challenging and may necessitate the use of a high-precision deformable optics. This topic is treated elsewhere in this report.



Nesting the mirrors into the Montel geometry provides a compact method for microfocusing, with advantages in terms of diffraction limit, demagnification sensitivity to figure errors, and sensitivity to vibration compared with traditional KB optics. The key challenge in producing high-performance nested Montel mirrors is the fabrication and characterization of high-quality mirror surfaces near the mirror edge, because the Montel geometry illuminates this near-edge area [3].

To produce nanofocused beams, precisely figured mirrors with fixed geometry are required. To fabricate an elliptical mirror from a mirror blank, deterministic computer-controlled fabrication processes combined with an advanced metrology are needed. Two examples are ion-beam figuring/finishing (IBF) and elastic-emission machining (EEM). The IBF method consists of using an argon ion stream in a vacuum to refine the surface profile. Data from optical metrology are coupled with computer-controlled tooling to correct localized surface errors. Using this method, optics with surface height errors  $<0.25$ -nm rms can be achieved. EEM, which was invented by Prof. Yuzo Mori and developed at Osaka University, Japan, is an effective method for producing subnanometer figured mirrors [4,5,6]. The EEM tool directs a jet of slurry precisely to the surface. The slurry particles chemically react with the surface, removing the undesired excess at the atomic level. A single Japanese manufacturer has access to this licensed capability and can produce both flat and limited-curvature focusing mirrors with slope errors as low as 30-nrad rms.

Another method of producing nanofocusing mirrors consists of selective deposition or adding material, rather than removing material, from a highly polished substrate to achieve the required surface figure. This method has been developed at Argonne National Laboratory and is being used to fabricate mirrors to focus hard X-rays to less than 100-nm spot size. (Also see *Thin Film Optics* chapter.)

#### **MIRROR THERMAL DEFORMATION**

When mirrors are used as the first optical component, they can experience high-power-density beams of over several 100 W/mm<sup>2</sup> (at normal incidence) 50 m from the source, resulting in an absorbed power density (in grazing incidence geometry) approaching 0.1-1.0 W/mm<sup>2</sup> depending on the mirror and beam parameters. This absorbed power creates temperature gradients that distort the optics and degrade the mirror performance.

Uniform heating of the mirror surface results in a temperature gradient into the depth of the mirror, producing a convex bend of the mirror similar to the bimetal strip thermal effect used in circuit breakers. This can be controlled via water-cooling and special distortion-compensating heat-exchanger geometries. Non-uniform heating, however, is much more difficult to manage. Non-zero thermal gradients along the optical surface tend to map directly into the figure error. For example, an absorbed beam power stripe of reasonably constant power density, narrow width, and extended but finite length, which is a rough approximation to the power deposited by an undulator beam into a grazing incidence mirror, will result in several- $\mu$ rad figure error in the sagittal direction (i.e., transverse to the beam and mirror long axis). A similar effect is observed in the tangential direction (i.e., along the beam and mirror long axis) if the power footprint is truncated owing to an aperture.

Clever heat-exchanger designs can improve the mirror performance, but ultimately mirror material properties limit what can be achieved. As with high-heat-load crystal monochromators (see the *Crystal Optics* chapter), the thermal deformation effects are a direct consequence of the finite thermal conductivity and expansion coefficients of the mirror materials, in which the figure of merit (FOM) for thermomechanical performance is the expansion coefficient divided by the thermal conductivity,  $\alpha/k$ . Single-crystal silicon is often used for mirror fabrication because of the high degree to which it can be polished and its reasonable thermal FOM.

Approximately two decades of third-generation light-source experience has evolved silicon mirror heat-exchanger designs to the point of diminishing returns, yet figure errors of  $\sim 50$ -nrad rms are outside the reach of room-temperature silicon mirrors for the absorbed power characteristics of the diffraction-limited synchrotrons and high-repetition-rate FELs noted above.

Other materials have been explored. For instance, chemical vapor deposition (CVD) silicon carbide has a twofold better thermal FOM than silicon, offering the opportunity for twofold performance improvement. Unfortunately, CVD SiC is very difficult to attain in the sizes and perfection required for grazing incidence optics. Moreover, the deterministic mirror surface-finishing techniques discussed in the preceding section are not directly transferable without optimization for SiC.

Perhaps a better approach, which preserves the existing significant investment in silicon surface deterministic finishing, involves using silicon mirrors cooled to liquid nitrogen (LN<sub>2</sub>) temperatures (i.e., 77 K). As the temperature of silicon is reduced from room-temperature, the thermal conductivity rises markedly and the expansion coefficient drops and reverses sign but remains small, below 125 K. This approach has been used for high-heat-load monochromators (see the *Crystal Optics* chapter) and it could easily be argued that the thermal performance of LN<sub>2</sub>-cooled silicon double-crystal monochromators is one of the great successes that have enabled the performance of intermediate and hard X-ray beamlines on third-generation light sources. Adapting and extending this technology to larger mirror optics is likely to have a similar impact on high-power, diffraction-limited light-source beamlines.

### **SURFACE CONTAMINATION AND X-RAY-INDUCED DAMAGE**

The loss of reflectivity owing to mirror surface contamination is a general concern for high-performance mirrors and tends to be most significant for carbon-edge studies, as the contamination layer generally has appreciable carbon content. Up to tenfold reflectivity losses have been experienced in just a few months of room-temperature soft X-ray mirror operation, owing to surface contamination. While the loss of reflectivity owing to carbonaceous contamination is less significant for hard X-rays, a non-uniform contamination layer will introduce wavefront errors. Given the sensitivity of soft X-ray applications to carbonaceous contamination of room-temperature mirror surfaces, it is not surprising that various approaches have been developed to minimize contamination (e.g., use of photoelectron collectors to minimize electron bombardment of contaminated vacuum-chamber surfaces that serve as carbon sources for mirror surface deposition) and to provide in situ cleaning options (e.g., ozone/ultraviolet or oxygen plasma cleaning). In situ cleaning, however, is not a complete panacea as studies have demonstrated that such cleaning techniques, though effective, can alter the surface morphology for oxygen-reactive surfaces. Moreover, the contamination problem is likely exasperated for cryocooled mirrors since the cold surface serves as a getter pump for condensable residual gas species.

Damage to mirror substrates/coatings from long-term radiation exposure is also a serious issue. Use of single-crystal silicon rather than engineered glasses for mirror substrates has largely eliminated mirror-body radiation damage and relaxation effects. However, optical coatings and associated interfaces remain susceptible to damage. Damaged mechanisms for coatings depend on the nature of the source, the mirror coating/substrate/multilayer type, and the mirror environment, though as a general rule mirrors that operate in a broadband radiation environment are more subject to damage than those illuminated by lower-intensity monochromatic radiation. Some possible damage mechanisms include optical coating layer interdiffusion, stress relaxation and radiation-assisted stress relaxation, chemical diffusion and radiation-assisted chemical diffusion, and radiation damage from high-energy X-rays. Data such as that shown in *Intensity Profiles from Mirrors with Figure Errors* in this chapter have been collected with a differential deposition-coated mirror fabricated at the Advanced Photon Source. But degradation of the focal spot size has been observed to increase over time, due to radiation-induced coating damage. Since these mirrors are illuminated by unfiltered undulator radiation, it is postulated that the observed radiation damage results from high-energy photon penetration through the optical coating to the radiation-sensitive oxide layer at the optical coating to mirror substrate interface.

Depending on the photon energy, FEL mirrors can absorb energy densities exceeding 1eV/atom on a per-shot basis. At these energy densities, which roughly correspond to thermodynamic melt criteria, mirror coatings can be damaged with every shot. For example, damage studies at the LCLS indicate B<sub>4</sub>C optical coatings reach the single-shot damage threshold at ~0.8eV/atom. As such, damage thresholds represent significant boundary conditions for FEL optics design and performance. FEL X-ray beams, with extraordinary pulse intensity, have added ablative damage to the list of concerns.

### **BEAM APERTURING**

Diffraction-limited sources present yet another challenge for grazing incidence mirror optics because the diffraction-limited spot size varies with the inverse of the acceptance aperture size. To avoid aperture-edge effects and increased diffraction-limited spot size, the ideal optics acceptance is four or five times the beam rms size at the optic. For hard X-ray optics operating at grazing incidence angles, this translates to rather large optics. For the 10-keV diffraction-limited example described above, the 5- $\sigma$  beam footprint at 3-mrad incident angle is over 900 mm. Maintaining the requisite optical performance over this large an optic is well beyond today's state of the art.

## R&D Directions for the Future

### MIRROR FABRICATION

Achieving the performance specifications summarized above will require further advances in deterministic mirror finishing at both long and shorter wavelengths to minimize the tooling “print through” into the final optical surface. Improved fabrication process-compatible metrology is a key factor in advancing the fabrication state of the art. The required mirror characteristics are extremely close to the present noise floor for short, flat mirror metrology and are beyond the state of the art for highly curved mirrors. Much of the effort in improving metrology concentrates on final optics characterization, where long equilibration times, low data rates, and repeated sampling for signal averaging are acceptable. However, to make real progress and reduce cost in the fabrication of high-perfection mirrors, vendors require metrology instruments capable of rapid (i.e.,  $\leq$ hour/measurement) but highly accurate surface morphology characterization for iterative surface figure refinement. Advancing the state of the art of such tools for integration into the fabrication process for feedback on mirror figure and finish is essential. Once process-compatible metrology tools are available, past history suggests that mirror vendors, spurred by customer requirements, will advance the fabrication state of the art to meet light-source needs without substantial further R&D investment by the Department of Energy. This issue is discussed in more detail in the *Optical and X-ray Metrology* chapter.

### MIRROR COOLING

Use of large LN<sub>2</sub>-cooled mirror optics entails several engineering challenges that require further development to implement successfully:

- **Cradle strain.** Cooling a silicon mirror to LN<sub>2</sub> temperatures involves large differential contraction relative to the mirror cradle, which is presumed to operate closer to room temperature. Managing this mirror-mount thermal strain is not an intractable problem, but requires extremely careful engineering and access to at-temperature metrology to maintain <50 nrad rms figure error.
- **Heat-exchanger strain.** Water-cooled mirrors, if not internally cooled, generally employ water-cooled heat sinks with a mechanically compliant Galn liquid-metal mediating thermal exchange between the heat sink and the mirror. Cooling to LN<sub>2</sub> temperatures ensures that any thermally mediating liquid will solidify, resulting in rigid mechanical coupling of the heat sink and the mirror, which will induce strain in the mirror. Development of an acceptably low-strain mechanical coupling between mirror and heat exchanger is essential to utilize LN<sub>2</sub> external cooling for large reflection optics.
- **LN<sub>2</sub> compatible bonding technology.** Internally LN<sub>2</sub>-cooled mirrors offer an alternative technology that does not suffer from heat-exchanger-induced strain. Internally cooled silicon mirrors are typically fabricated from two silicon parts with machined heat-exchanger features and bonded via a glass frit layer. Repeated LN<sub>2</sub> emersion tests of bonded silicon assemblies have demonstrated that the frit bond offers a robust joining technology capable of withstanding repeated thermal cycles while remaining ultrahigh vacuum leak tight. The current process used for the existing manifold-to-silicon bond, however, does not survive LN<sub>2</sub> thermal cycling. For internally LN<sub>2</sub>-cooled mirrors to become viable, development of a robust manifold-to-silicon joint is essential.
- **Cryocontamination.** A cryocooled mirror inside a room-temperature vacuum system serves as a getter pump for condensable residual gas species, resulting in optical surface contamination. As discussed below, contamination-mitigation strategies must be developed for a range of mirror optical-coating materials.
- **At-temperature metrology.** The significant contraction of a cryocooled mirror upon cooldown necessitates at-temperature figure metrology for strain management of the cryomirror system. The development of an at-temperature laboratory-scale metrology system with the requisite sensitivity is a major undertaking. Consequently, it is likely at-temperature metrology will be restricted to in situ X-ray diagnostics. Refer to the *Optical and X-ray Metrology* chapter for further discussion of in situ metrology.

### MIRROR CONTAMINATION AND X-RAY-INDUCED DAMAGE

The importance of surface contamination in performance degradation of coherent X-ray beam optics, whether utilizing cryocooled or room-temperature mirrors, argues for more systematic study of the contamination

and in situ cleaning problem. In particular, the following issues require more investigation: (1) optimization of parameters for continuous in situ cleaning of different optical coatings, (2) the long-term consequences of such continuous mirror cleaning on optical surface morphology, and (3) alternative in situ cleaning techniques for optics with more oxygen-reactive surfaces.

Given the large investment in very-high-performance optics for diffraction-limited light sources, it is essential to develop a more systematic understanding of optics damage issues. Necessary research thrusts include (1) damage mechanisms, (2) quantitative understanding of damage onsets, and (3) the development of damage-mitigation strategies. This is particularly crucial for FEL mirror coatings for which empirical experience with single-pulse damage issues is substantially more limited than damage of synchrotron optics.

### NOVEL MIRROR CONCEPTS

To attain ideal diffraction-limited foci, it is essential to avoid beam-truncation effects resulting from finite acceptance apertures. In the context of intermediate and hard X-ray grazing incidence mirrors, this can result in quite large mirrors and associated fabrication challenges. Novel apodizing optics may provide alternative means to avoid aperture effects by “filtering” the beam to smooth the beam truncation associated with more modest-size mirrors. Apodizing schemes could involve engineered optical coatings or introduction of an appropriately tailored transmission filter. Unfortunately, these concepts likely would compromise the achromatic focusing of reflection optics. Useful realizations of such X-ray optics requires development of practical apodizing implementations that do not sacrifice the achromatic advantages of grazing incidence reflection optics nor introduce other potentially more severe structural artifacts in the reflected beam.

## Impact

Because X-ray mirrors are so widely used throughout the entire X-ray spectrum, any advances in mirror quality or performance will have a significant impact across a large number of research programs. For this reason alone, improved mirror fabrication processes, enhanced mirror cooling, and a better understanding of radiation-induced mirror damage are crucial advances.

Many important phenomena in nature involve micro- and nanoscale processes localized to surfaces, interfaces, small grains or grain boundaries, and cell boundaries. Such processes govern a broad range of important physical, chemical, and biological characteristics central to furthering materials by design, understanding quantum phenomena in solids, improving catalysts for energy production and storage, developing new pharmaceuticals, etc. X-ray techniques utilizing penetrating, nanofocused beams provide an essential means

### Intensity Profiles from Mirrors with Figure Errors

False-color simulated intensity profiles for the 10-keV diffraction-limited example of the text calculated at the focus (left), 1 mm from the focus (middle), and 2 mm from the focus (right). The upper row simulates the effect of 0.3-nm rms figure height error while the lower row depicts that of 1-nm rms figure height error. The resultant wavefront error has limited impact on the focus spot size, but even slightly off the focus, the beam structure introduced by 1-nm rms figure height error is profound. (*Simulation results courtesy Jacek Krzywinski: LCLS using measured LCLS mirror height error data.*)

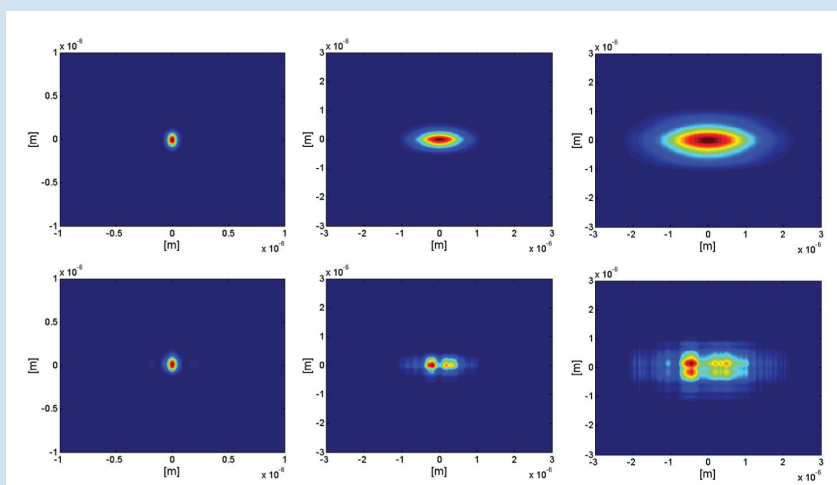

to elucidate key structural, electronic, and chemical aspects of these phenomena in situ and in operando without the sample modifications required of many non-X-ray based techniques. Nanoprobe spectroscopy measurements, for example, provide chemical composition and oxidation-state information in the illuminated volume of the sample. Similarly, nanodiffraction measurements reveal the atomic-scale structure of the illuminated volume (see *3-D Microdiffraction* in this chapter). A central unifying theme of these nanoprobe techniques is the utilization of extremely small focus spots to limit the X-ray probe volume (voxel) to the sample region of interest. Reflective optics provide a relatively straightforward means to accomplish such focusing.

Since the real-space resolution of the probe is directly determined by the focus spot size, such techniques require extremely high-perfection mirrors for the production of highly focused beams. Not only does the focus perfection directly relate to the size of real-space features elucidated, but it also factors into the weakest resolvable signal. Many of these nanoscale phenomena provide relatively weak signatures in the data that are difficult to extract from background noise. Maximizing the incident flux contained in the focal spot generally enhances the signal-to-background, resulting in sensitivity to more subtle effects otherwise not accessible to the measurement technique. Thus, the perfection of the focusing optics contributes fundamentally to the minimum resolvable real-space features that can be studied.

Measurements that exploit the coherence of the X-ray beam, such as coherent X-ray imaging of isolated molecules or molecular clusters, are acutely sensitive to X-ray beam wavefront errors introduced by optics imperfections. In general, the wavefront spatial gradient must be lower than the spatial gradient of the sample feature of interest. Present understanding suggests 1-5% maximum wavefront variation is required for successful 3-D reconstruction of isolated molecules or clusters. Such perfection of the wavefront places severe constraints on the focusing optics' quality. It should also be emphasized that any measurement technique that utilizes the beam in a geometry that is slightly off the focus waist, such as for better matching of the beam to the sample size, is similarly sensitive to wavefront error because the consequent beam structure can couple to the sample variation, resulting in data-interpretation challenges (see *Intensity Profiles from Mirror with Figure Errors* in this chapter).

In summary, optimizing the performance of grazing incidence reflection optics to extract the full potential of the current and future Department of Energy investment in diffraction-limited X-ray sources implies <50-nrad rms slope errors (ideally ~25-nrad rms) and  $\leq 0.5$ -nm rms figure height errors (ideally ~0.3-nm rms) for surface error wavelengths ranging from a few millimeters to the full optical aperture of the optics, which can approach 1 m for hard X-ray optics. Shorter wavelength surface errors (roughness) should be <0.1-nm rms (ideally ~0.05-nm rms) for error wavelengths down to the X-ray extinction length with somewhat larger surface errors tolerable at even shorter wavelengths.

## References

1. A. Maréchal, *Etude des effets combinés de la diffraction et des aberrations géométriques sur l'image d'un point lumineux (Study of the combined effects of diffraction and geometrical aberrations on the image of a luminous point)*,” Rev. Opt. Theor. Instrum. 26, 257–279, 1947.
2. G.E. Ice, J.D. Budai, and J.W.L. Pang, *The race to X-ray microbeam and nanobeam science*, Science 334, 1234, 2011.
3. W. Liu et al., *Achromatic nested Kirkpatrick-Baez mirror optics for hard X-ray nanofocusing*, J. Synchrotron Rad. 18, Part 4, 575, 2011.
4. H. Tsuwa et al., *Numerically controlled elastic emission machining*, Annals of the CIRP 28 19, 193, 1979.
5. Y. Mori et al., *Development of plasma chemical vaporization machining and elastic emission machining systems for coherent X-ray optics*, SPIE 4501, 2001.
6. K. Yamauchi et al., *Figuring with subnanometer-level accuracy by numerically controlled elastic emission machining*, Rev. Sci. Instrum. 73, 4028, 2002.

# Optical and X-ray Metrology

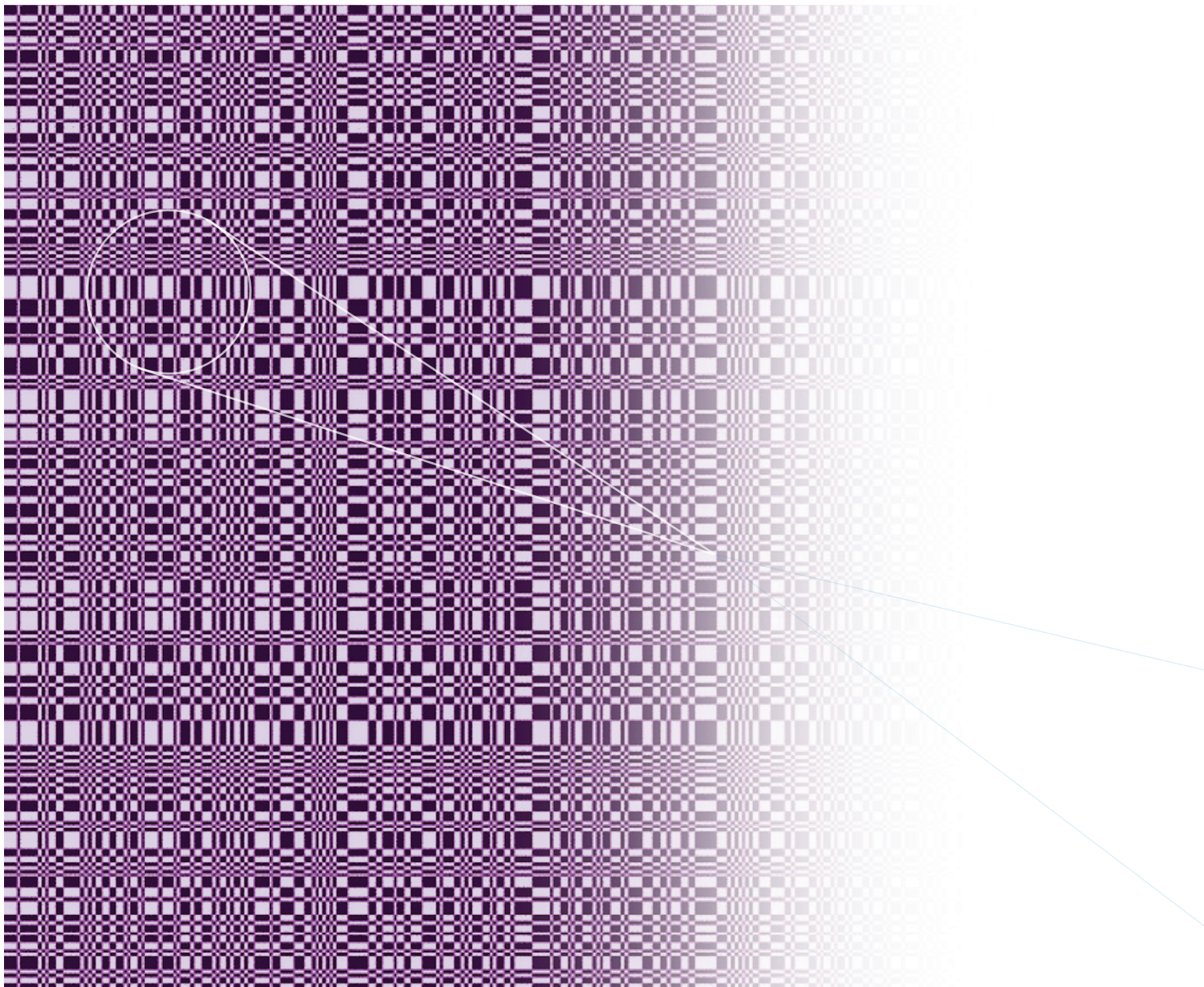

## Summary

Maintaining the brightness of synchrotron and free electron laser (FEL) X-ray sources requires optical elements manufactured to very high tolerance that maintain their characteristics under beamline operational conditions. To do this, we need methods to measure the characteristics of optical elements, such as figure error and mirror roughness, or the phase coherence of diffractive optics, such as gratings. In the case of mirrors, at current sources we need a manufacturing accuracy in slope error of  $<0.05$  microradians ( $\mu\text{rad}$ , root mean square [rms]) and a height error of  $<0.5$  nm (rms) on elements up to 1 m in length, for the most demanding cases. We need methods that work at optical wavelengths in the laboratory, mainly for the testing of optical elements assembled

into complex optomechanical systems. We also need methods that work in situ at X-ray wavelengths in the beamlines, to assess operational performance of a complete system and to guide alignment of system components. This general area can be classified under the term “Optical and X-ray Metrology.” Below, we summarize four areas to be addressed, and map out potential avenues for R&D.

### Working Group Chairs:

M. Idir (BNL)

V. Yashchuk (LBNL)

### List of contributors in alphabetical order:

S. Alcock (Diamond Light Source, UK)

L. Assoufid (ANL)

D. Bajuk (Zygo)

J. Burge (University of Arizona)

D. Cocco (SLAC)

R. D. Geckeler (PTB, Germany)

K. Goldberg (LBNL)

U. Griesmann (NIST)

M. V. Gubarev (NASA MSFC)

K. Kaznatcheev (BNL)

J. Krzywinski (SLAC)

A. Macrander (ANL)

W. McKinney (LBNL)

P. Naulleau (LBNL)

L. Poyneer (LLNL)

J. Robichaud (L-3 Communication)

L. Samoilova (XFEL, Germany)

K. Sawhney (Diamond Light Source, UK)

F. Siewert (HZB/BESSY-II, Germany)

R. Soufli (LLNL)

P. Su (University of Arizona)

P. Z. Takacs (BNL)

O. Chubar (BNL)

T. Tonnessen (InSync, Inc., USA)

M. Tricard (Zygo)

H. Wang (Diamond Light Source, UK)

K. Yamauchi (Osaka University, Japan)

## RECOMMENDATIONS

- 1. Work with industry to develop advanced metrology tools that can be used as part of the manufacturing process.** Optics quality is directly linked to the accuracy of the metrology used in fabrication. One important example is the manufacture of X-ray mirrors, where future advances in metrology will be needed to drive improvements in mirror quality. This metrology is a fundamental part of the manufacturing process and should be located at the point of manufacture. DOE optical laboratories should take an active role in assisting industry to develop standard metrology platforms. In general, the cost and effort relative to business volume of the light-source community has not motivated most manufacturers to make these investments on their own, and the DOE laboratories should be ready and able to openly assist in developing these new capabilities.
- 2. Develop and implement at-wavelength X-ray metrology that can be used routinely in beamlines in a minimally invasive manner to aid in measurement of optics and their alignment in systems.** A suite of at-wavelength X-ray metrology tools should be developed for standard use in beamline applications. X-ray metrology should not be overly disruptive to beamline operation and should allow routine evaluation of the performance of optical components. This includes diagnostics and control of the optical-system alignment and performance within given operational conditions. Further, at-wavelength metrology is expected to go beyond the fundamental limits of optical metrology and thus will be instrumental in the development of next-generation optical components (e.g., coherence-preserving optics).
- 3. Develop and support R&D X-ray beamlines for X-ray metrology of optical elements, both prior to installation in a beamline and as part of the development of new optics and detectors.** The availability of test-beamlines fully dedicated to R&D in optics is crucial to innovative optics development. They are also of key importance for developing



and testing detectors. There are key measurements of X-ray optical components that require X-rays, but must be evaluated externally to an operating user beamline. These measurements include multilayer mirror and grating diffraction efficiency, mirror reflectivity and scattering, crystal quality evaluation, zone-plate focusing and efficiency, and many other tasks. The facilities required cover the full spectral range and can be classified as hard X-ray in-air measurements and soft X-ray in-vacuum measurements. In each category, the standard tool is a beamline with a multi-axis diffractometer for scattering and efficiency measurements, and a more general beamline that can be set up in a variety of ways depending on specific measurement tasks. An existing patchwork of beamlines provides some of the functions described above, but must be consolidated and supported in terms of operational manpower, and enhanced where necessary. Ideally, the capabilities would be geographically distributed and allow quick and easy access.

- 4. Upgrade and maintain existing optical-metrology facilities at light sources to provide measurement capabilities commensurate with the high brightness of sources.** The center of gravity of conventional optical metrology should be at manufacturer's facilities. The role of optical metrology at light sources should be to proactively support the development of new tools to be deployed to manufacturing sites, and to provide tools uniquely required at the facilities. For example, the long trace profiler (LTP) provides a convenient way to set mirror adjustments before mirrors are put in a beamline, and is used to assess the effect of mechanical mounting, bending, vibration, and cooling on the overall performance of an optical element. Optical metrology at facilities also enables a critical assessment of optics that may have degraded after operation in beamlines. Optical-metrology laboratories are an essential element of every modern light source and should be kept at a good operational level, sharing knowledge and developments without unnecessary duplication of effort and resources. In addition, these labs should develop a standardized specification understood by the manufacturing community, and universal tools for calibration and assessment of manufacturer's metrology.

### Surface Imperfections Cause Different Types of Imaging Problems, Depending on Spatial Frequency of the Errors

A mirror will focus a diffraction-limited source to an Airy diffraction pattern in the image plane. This image will be distorted by deviations of the surface from the correct shape. Low spatial frequency errors with a period typically in the 1 mm to 1 m (full aperture) will cause a redistribution of intensity in the whole image. Midspatial frequency errors with a period in the range from microns to a mm cause a redistribution of light from the core into the region just outside the diffraction-limited focus. High-frequency errors with a period from nanometers to micrometers will cause a redistribution of the core intensity into the wings of the focus, far from the core. The deviation of the mirror surface from the correct shape can best be described by the power spectral density (PSD), a function derived from the squared modulus of the Fourier transform of the errors. One function of metrology is to measure these errors and form the PSD over the relevant frequency range.

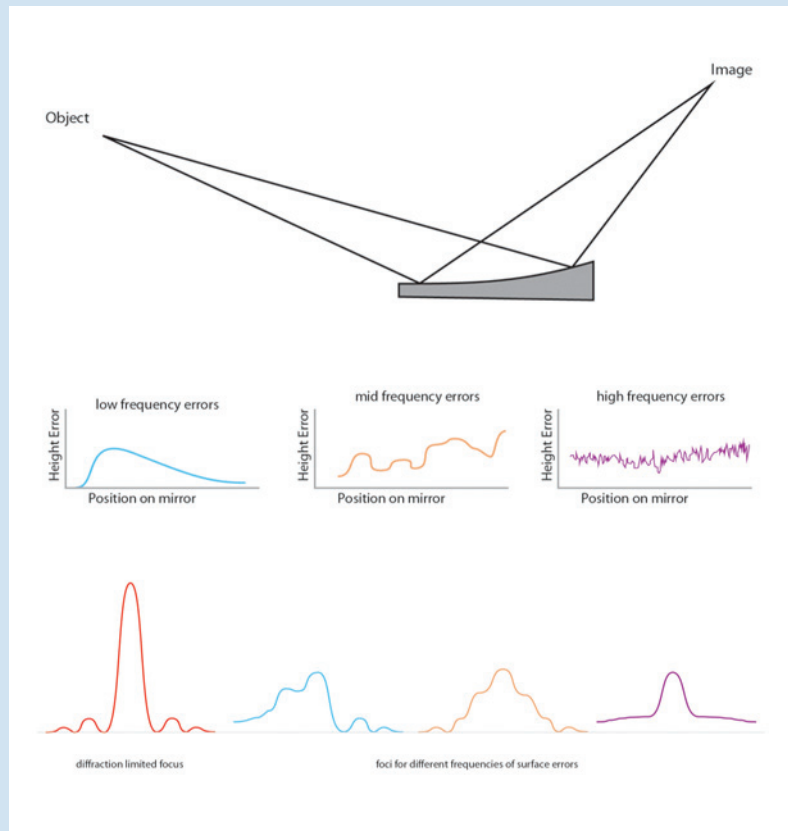

## Scope

One of the most important characteristics of a beam is brightness. Brightness is defined by the flux (photons/sec/bandwidth) divided by the emittance of the beam. The emittance is simply the product of the source size and divergence in both horizontal and vertical planes. A lower-emittance beam is a brighter beam, and can be focused efficiently to smaller dimensions. The development of synchrotrons — from the first generation of parasitic operation on high-energy-physics machines to today's third-generation machines — has been one in which the emittance of the electron beam has been lowered through more advanced storage-ring lattice design, and the intensity increased through the use of periodic magnetic structures, undulators. Modern synchrotron X-ray sources have an electron-beam emittance in the vertical plane small enough that the emission from an undulator source is close to being diffraction limited, i.e., the product of the rms beam size and divergence is given by  $\lambda/4\pi$ , where  $\lambda$  is the wavelength of the X-rays. In the horizontal plane, beam size and divergence are much larger and the emission is not diffraction limited. In the new generation of storage rings such as MAX IV, further development of the storage-ring magnetic lattice will result in X-ray emission in the vertical and horizontal plane being fully diffraction limited in the soft X-ray energy region; extension of these basic concepts will allow fully coherent emission in the hard X-ray domain. FELs already achieve full coherence into the hard X-ray region.

This sets the context for the metrology of X-ray optical components. We must be able to determine the performance of X-ray optical components at or close to the diffraction limit. As an example, the vertical beam size in modern storage rings is typically around  $10\ \mu\text{m}$  (rms). The first mirror might be 20 m from the source, so the full angular size of the source is  $0.5\ \mu\text{rad}$ . A mirror will cause the light to deviate by twice any angular error, and we wish the error to be small compared with the source angular size. A typical tolerance is that the figure error deviation from the perfect shape should be less than one-fourth the angular source size. In this example, the corresponding figure error tolerance should be less than  $0.125\ \mu\text{rad}$  (rms). Due to the large distance from the source and the small grazing angle that must be used to efficiently reflect X-rays, this tolerance often must be achieved over a mirror length of 1 m or more. In other cases, such as in the long beamlines encountered at FELs, or in very-high-resolution spectrometers, the angular size of the source can be even smaller, demanding fabrication and measurement accuracy down to 50 nrad (rms). In cases where the mirror is used with coherent light as in a FEL or is used in an imaging application, rather than considering geometrical distortion from a perfect shape, we need to consider an acceptable wavefront distortion as a criterion. Usually the Marechal criterion is used, which stipulates that a well-corrected optical system will have a wavefront distortion of  $<\lambda/14$ . At the mirror surface, this amounts to  $\lambda/28\theta$ , where  $\theta$  is the grazing angle. Applying this to a grazing incidence mirror at 3 milliradians grazing angle and a hard X-ray wavelength of 0.1 nm, we arrive at an rms height deviation of  $<1.2\ \text{nm}$ . As the critical angle  $\theta_c$  scales as  $\lambda$ , we would have a similar value for a soft X-ray mirror. Surface figure and height deviations usually are most important in the long spatial wavelength regime from a fraction of a mm to the mirror length when considering image formation. High spatial-frequency deviations, which we can classify in terms of roughness in the nm to micron spatial wavelength range, are important in terms of optical scattering into small angles around

### Ex Situ Optical Metrology Tools Typically Used to Assess X-ray Mirrors and Gratings

Common tools of ex situ optical metrology for X-ray optics [1]. From top to bottom, in order of increasing spatial frequency: A long trace profiler (LTP) measuring from millimeter to meter spatial wavelengths; a plane-wave interferometer, measuring from a fraction of a mm to 150 mm spatial wavelengths; a phase-shifting interferometric microscope measuring from micron to mm spatial wavelengths with sub-angstrom height resolution; an atomic force microscope (AFM) measuring from nanometers to 10 micrometers period, with angstrom height resolution.

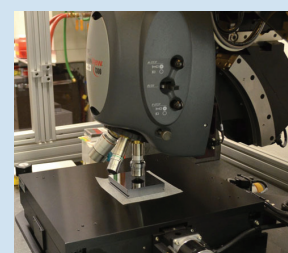
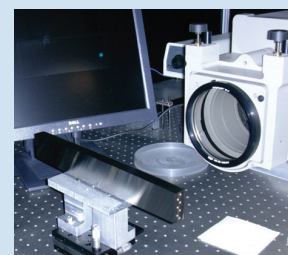
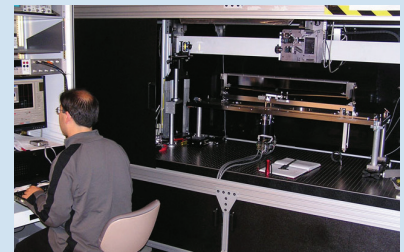

a specularly reflected beam, resulting in a loss of reflected intensity. In this spatial-frequency domain, rms height deviations of typically  $<0.5$  nm are required. More precisely, we can define a surface in terms of its power spectral density (PSD) that is essentially a Fourier decomposition of the surface height deviations.

The quantities mentioned above define the general requirements for the metrology of X-ray mirrors. Gratings have additional requirements such as periodicity, which often is required to vary in a proscribed way as a function of position on the surface. Groove shapes and depths also are defined to set levels of accuracy. For example a soft X-ray grating will typically have a groove depth of around 10 nm, with a required accuracy of  $\pm 1$  nm. Deviation of the groove depth or the groove blaze angle will cause a shift in the wavelength at which the maximum efficiency is reached and will affect overall wavelength coverage. Crystal optics has its own set of demanding requirements in terms of, for example, surface figure, residual strain, and the orientation of the surface relative to the lattice planes.

To manufacture optics to the levels outlined above, suppliers must use their own metrologies with the requisite accuracy. The role of metrology at DOE light sources is therefore to complement the existing manufacturing metrology primarily in the following areas:

- Qualification and pre-alignment of optics assembled into an optomechanical assembly, where the mirror might be subject to mounting stress, bending stress, water-cooling forces, and vibration, and the characteristic responses of the system must be measured. This is a task carried out with visible light in the laboratory.
- Qualification, fine-tuning, and alignment of optics assembled into systems in a beamline. This is a task that must be carried out at wavelength with X-rays, using diagnostics built into the beamline.
- Development of optics not readily available from industry, such as aspheric surfaces created by differential deposition, high-order multilayer gratings, multilayer Laue lenses, etc. In each case, the quantity is insufficient to interest the industrial market, but metrology is needed.

### Mirrors Must Be Evaluated in Complex Mechanical Assemblies

A Kirkpatrick-Baez (KB) mirror assembly [2] for two orthogonal microfocusing mirrors. Flat mirrors are mechanically bent into ellipses. They can be detwisted and adjustments made in roll, pitch, and position. The quality of the focusing depends not only mirror quality, but on the quality and stability of the complex optomechanical system.

Complex optomechanical systems must be measured within the framework of complex optical-measurement instrumentation. Here, a hard X-ray mirror mounted on its bending and mounting mechanism is shown assembled on its base flange ready for installation in a beamline, mounted on an LTP for measurement and radius setting.

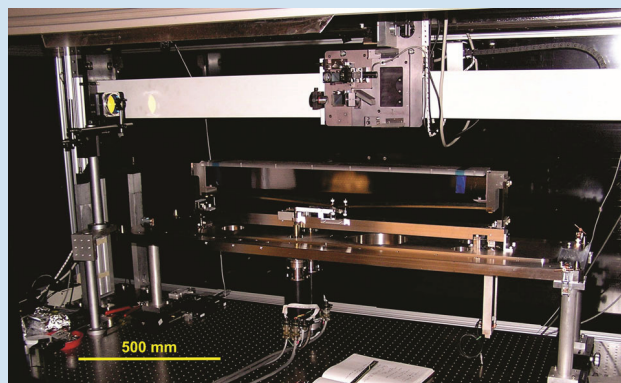
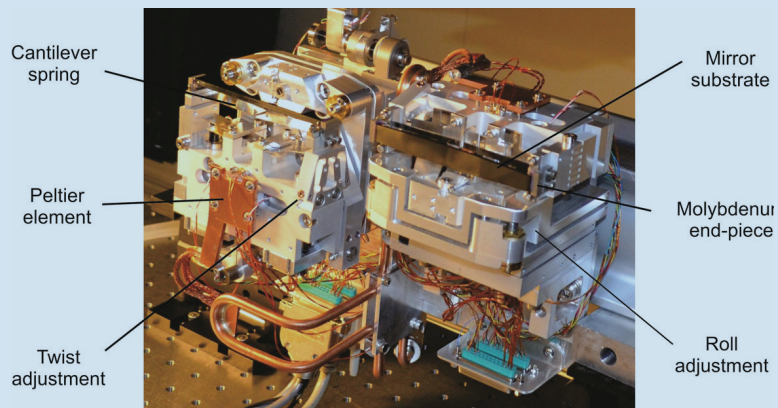

- Assisting industry in the qualification of manufacturing metrology and providing assistance in the development of new metrology tools and dedicated calibration processes when required.
- Measurement of the performance of single optical components at the X-ray wavelengths they will be used, as part of R&D or as part of the qualification of a component. For example, X-ray diffraction data for gratings in the soft X-ray region cannot easily be provided by manufacturers, and requires the use of a diffractometer at a synchrotron beamline.
- Assessment of optical components removed from beamlines after periods of use. The performance of X-ray optics generally decreases with time due to strain induced by high heat load, contamination, thermally induced roughening of mirror coatings, and many other factors. It is necessary therefore to be able to quantify the various aspects of the optical element and recommend remedial measures that could be taken, such as carbon-contamination removal, coating replacement, or in some cases replacement of the optical element.

## Issues

Light-source brightness has increased by typically 3 orders of magnitude for each generation of storage ring. Extrapolation to a new generation of diffraction-limited machines on the near-term horizon will yield another factor of 3 orders of magnitude. The peak brightness of FELs is in addition 10 orders of magnitude higher than that of storage rings. In metrology, the problem is that in several key areas, the requirements for optical components and systems have outstripped our ability to measure and align optics; therefore, in many cases beamlines today significantly degrade source brightness. This mismatch between actual and potential performance will get larger as source brightness continues to increase, unless we make the appropriate investments. Here we outline the main issues that confront us today.

- **Need to increase the accuracy of metrology.** We have a range of tools to measure optics in the laboratory, from commercial plane-wave interferometers and phase-shifting interferometric microscopes to highly specialized deflectometer-based instruments such as the LTP and the Nano-Optic-Measuring (NOM) machine. Using a combination of these systems, we need to be able to characterize the figure and finish over an enormous spatial wavelength range from submicron

### The Workhorse Instrument for Measurement of Figure Errors: The Long Trace Profiler (LTP)

The LTP-II shown above is a complex system that uses a lens to map angular displacements to position displacements on a CCD detector. The optical sensor head is suspended with an air-bearing translation system on a ceramic beam to interrogate the whole length of an optical element. A reference beam is used to measure the angular errors of the sensor head as it traverses along the beam. The conception of the LTP was invented in 1989 [3].

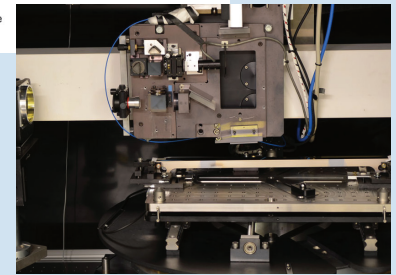
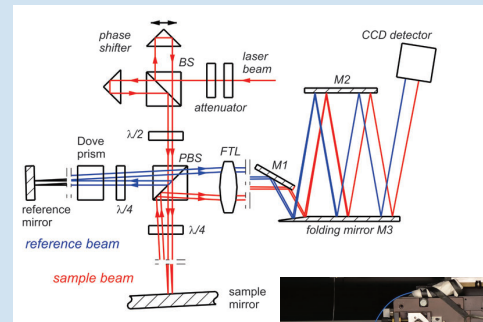

The movable pentaprism LTP as pioneered in the BESSY NOM [4] uses an electronic autocollimator to encode angular displacements; the pentaprism makes the system insensitive to carriage-wobbling errors as the measurement head is translated. The accuracy of this system is fixed by the accuracy of the commercial autocollimator and is limited by the static (fixed-distance) calibration currently available.

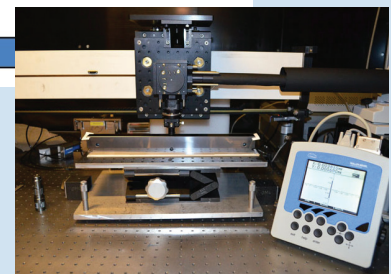
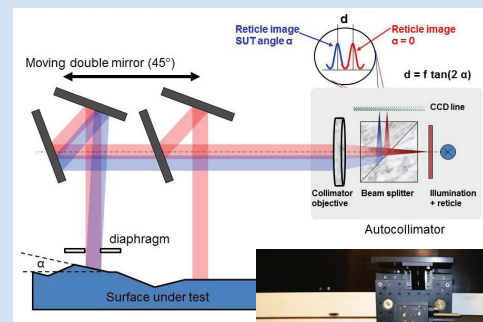

### Figure Measurements on Flat Mirrors Using Long Trace Profilers (LTPs) Can Be Extremely Precise

Here, one of four silicon grating substrates has been measured using two completely different types of long trace profilers (LTP and penta-prism type). The left panel shows the two slope-error measurements, and the right panel shows the average of the two and the difference. This shows that the difference between the two is 0.06  $\mu\text{rads}$  (rms) [5]. Because multiple measurements are required to correct for systematic errors, the measurements are challenging and very time consuming, in some cases taking weeks.

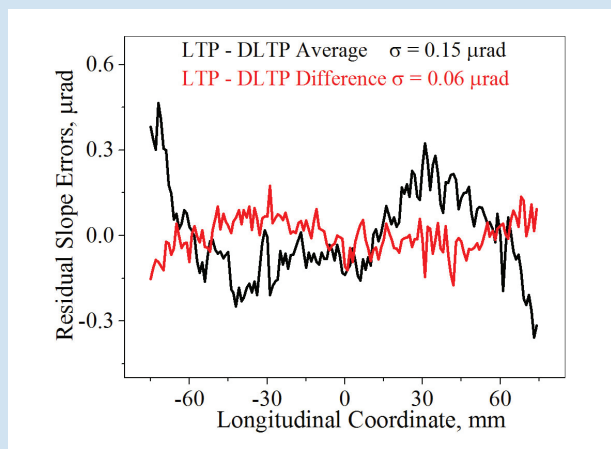
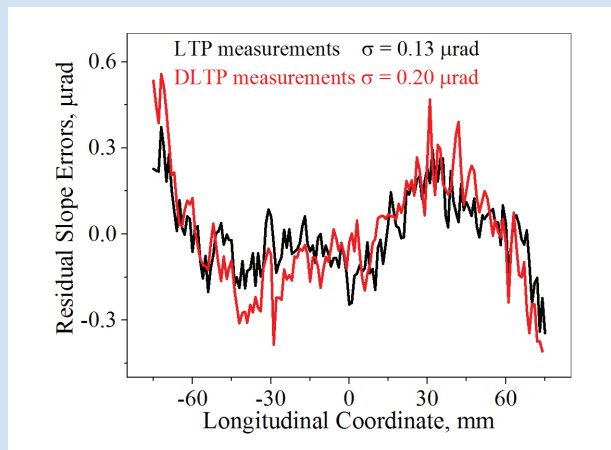
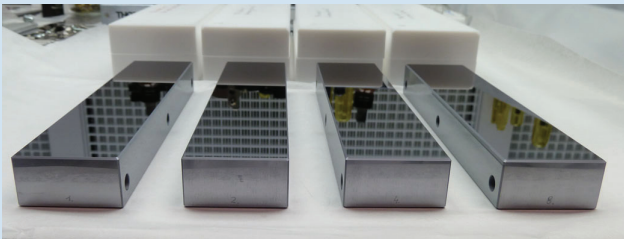

to the full aperture of a mirror, with height and slope rms accuracy less than 0.5 nm and 50 nrad, respectively. While we have sensitivity precision at this level, we do not have accuracy. In addition, at the limit of accuracy we can achieve today, single measurements on optics with, for example, the LTP can take weeks, greatly reducing the technique's utility. This also means we cannot comprehensively test optical elements over their full aperture, and we cannot measure under all conditions to which the mirror will be subjected in operation. We can only selectively probe the system.

- Need to have ultrahigh-accuracy metrology at the manufacturing site.** Ultimately, optical elements should be mounted in optomechanical systems ready for use in a beamline, and qualified by optical metrology at the accuracy required for each application. However, many of the optics required for FELs and diffraction-limited storage rings are beyond the current state of the art, not because of limitations in fabrication and polishing technique but because of limitations in measurement accuracy. In other areas where very large optics are needed (e.g., James Webb Space Telescope) or ultra-accuracy standardized optics are required (e.g., EUV lithography), the cost of single optics justifies the development of highly specialized ultrahigh-accuracy metrology. In synchrotron optics, we have a relatively small volume of optics with a wide diversity of shapes and sizes, and therefore it isn't financially viable for a manufacturer to develop metrology tools of the required accuracy based on this type of market. For example, the average total market from DOE light sources per year in mirrors and gratings is of the order of \$5 million for perhaps 50 optical elements, including flats, spheres, ellipses, and sagittal cylinders. We can compare this with the approximately \$10 million each for the 18 identical segments of the James Webb Space Telescope primary mirror, or the approximately \$50 million for each objective mirror system for an EUV lithography printer. In these cases, clearly the total market and volume of identical elements makes investment in specialized optical metrology financially viable.

- Lack of access to and support for R&D X-ray beamlines.** As well as optical metrology, it is vital to have access to X-rays to measure a range of properties, such as reflectivity, bandwidth, off-specular scattering, and many other characteristics. Unfortunately where such facilities exist, they are essentially unfunded and run without a mandate to serve the wider optics community. Access is ad

hoc and intermittent, making sustained R&D using these facilities difficult. With dedicated access, we could develop figure-measurement metrology to achieve a performance level significantly beyond what can be achieved with visible light. We also need such facilities to essentially duplicate beamline conditions, so that mirrors extracted from a beamline after prolonged use that are suspected of performance issues can be diagnosed with X-rays. One example is the measurement of mirrors that have developed increased scattering, limiting their use for microfocusing. X-ray diagnostic tests would reveal the origin of the problem and the likely corrective action to be taken.

- Lack of at-wavelength X-ray metrology in beamlines.** The ultimate performance that we care about is when an optical element is installed within a beamline. However, the necessary tools to adequately measure performance and adjust the myriad parameters required for optimum performance are often absent. In many cases, tools that can be used robustly yet are minimally invasive for routine use in a beamline have not been developed. Furthermore, it is clear that ultimate accuracy can be obtained by measurement with X-rays, rather than in the laboratory with optical light. Using techniques such as X-ray Hartmann sensing and grating shearing interferometry, accuracy better than the required goals should be achievable. Indeed, in the cases where these techniques have been applied, such as in the development of optics for EUV lithography, extreme accuracy has already been demonstrated. What's needed is development of a suite of tools that can be applied robustly throughout the whole X-ray spectrum, not just for specialized applications in the EUV.

The problems outlined above can severely impact the performance of beamlines, reducing their performance in some cases by orders of magnitude. They can also affect efficiency in that often optics must be used in the beamline without adequate offline metrology. This means that very valuable beam time is used to diagnose problems and align elements, rather than to carry out science.

## R&D Directions for the Future

As described above, a range of issues must be addressed to get the best performance out of our existing beamlines and to prepare us for new generations of ultrabright sources. In this section, we present some of the most promising directions for a future R&D program in the metrology of X-ray optical components to meet these challenges

- Enhance manufacturing metrology.** As explained previously, high-accuracy metrology that can be used during manufacturing processes should be improved. This is problematic due to (1) the great diversity of optical elements that have to be manufactured, and (2) the overall small size of the market. One complication is the very high cost of developing suitable metrology. This complex problem could be potentially solved in a number of ways. If the manufacturing needs of the whole community were coordinated, the range of metrology tools that would need to be developed could be minimized. This would also allow cost sharing among institutions to develop new, advanced metrology tools to be placed at manufacturing sites. There clearly would be contracting issues to resolve, but because there are very few U.S. companies that currently supply optics to the DOE BES light-source facilities, such an approach should be considered. Another

### Stitching Shack-Hartmann Profiler: A New Way to Ultrahigh Accuracy

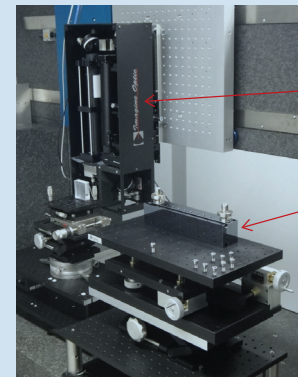

A new slope-measuring method uses the scanning system of an LTP but slope is measured with a very-high-quality Shack-Hartmann wavefront sensor. The analysis pupil size of the sensor is  $18 \times 13.2 \text{ mm}^2$ , with a spatial resolution of 1.2 mm (size of the microlenses), and at each point the local slopes are measured in directions X and Y. These slope maps are the two derivatives of the mirror surface. We then have redundancy that can be used to reduce the measurement noise and systematic errors. Moreover, the 2-D integration is less noisy than 1-D integration, as several paths can be considered to calculate the mirror height.

2-D map of residual slope errors of a flat mirror [rms slope error of 161 nrad (rms)]. This type of measurement allows rapid 2-D evaluation of a mirror to high accuracy.

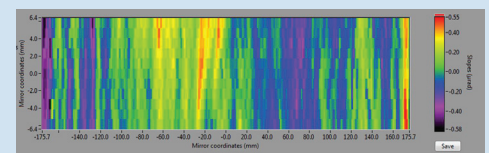

approach to stimulate this type of investment could be through the Small Business Innovation Research (SBIR)/Small Business Technology Transfer (STTR) process, if a call was made in advanced manufacturing metrology. Direct investment could be made in companies, but also metrology technology developed in the national laboratories could be transferred to industry under STTR. Finally, the creation of a grant-proposal process to which industry and laboratories could apply for coordinated R&D in this area could mitigate this problem. The main point is that the community must organize across facilities, and start a coordinated discussion with optics manufacturers to define the most appropriate way forward.

- Enhance laboratory-based optical metrology.** The primary rationale for laboratory-based optical metrology is to measure and optimize the performance of optomechanical assemblies before they are deployed in beamlines. Secondly, it is to develop tools and techniques to assist in manufacturing metrology, and to act as a resource for the qualification of vendor metrology. To this end, several key developments are needed in an R&D program:
  - Develop a new generation of slope- and height-measuring systems for low- and mid-spatial frequencies.** This would include further development of deflectometry-based systems (NOM and LTP-type) with the aim of achieving an absolute slope-error accuracy of  $<30$  nanoradians and 2-D operation, as well as stitching interferometry for absolute height determination to an accuracy of  $<0.2$  nm.
  - Develop a suite of calibration tools to allow absolute measurements, and for calibration of the modulation transfer function (MTF) of optical instruments such as phase-shifting interferometric microscopes and atomic force microscopies (AFMs).** The MTF is the magnitude of the amplitude response of a system to a continuous range of spatial frequency inputs.
  - Develop tools that would allow the high-accuracy evaluation of line density in variable-line-spacing gratings.**

### Binary Pseudorandom Arrays: A Way to Correct the Frequency Response of Optical Measurement Systems

Left: A binary pseudorandom array (BPRA); right: details of the electron beam written and etched silicon structure. These structures can be used as a white spatial frequency noise source that can be employed to correct the frequency response (modulation transfer function, MTF) of an optical system used for PSD measurements with a mirror [6].

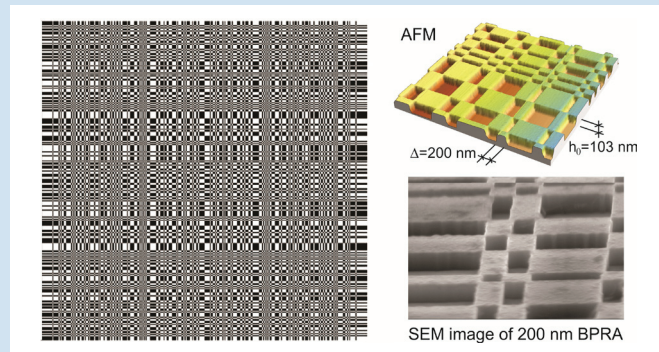

The BPRA has been used to correct the power spectral density (PSD) obtained from an ultrasmooth aluminum mirror. (2) Shows mirror-surface PSD obtained with the uncorrected instrumental response; (1) shows the corrected mirror PSD distribution. An uncorrected response leads to an incorrect estimate of the surface roughness.

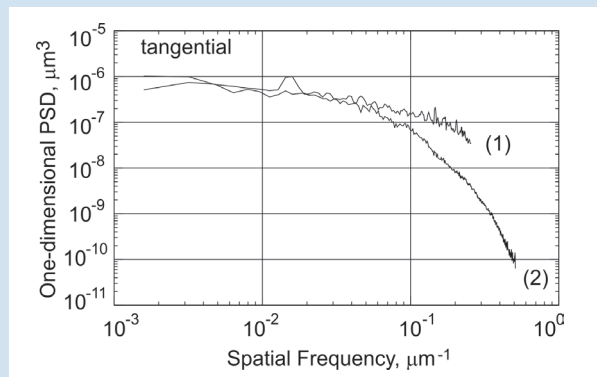

- **Develop at-wavelength metrology tools.** The most precise tools for metrology and those most relevant to ultimate beamline performance will use X-rays at the wavelength at which the optical system will eventually be used. These at-wavelength metrology tools can be classified into two groups:
  - **In-beamline metrology.** Most beamlines today have minimal tools for assessing the performance of the optical system and for system alignment. We need a standard set of tools that allow minimally invasive measurements of system performance and that can be used routinely as part of user operation. The simplest are based on techniques such as Hartmann masks and grating shearing interferometers. These must be integrated into the beamline system [9].
  - **At-wavelength X-ray testing.** In this classification, mirrors will be assessed at wavelength, prior to installation in a beamline. The aim will be to minimize beamline downtime and to provide an accuracy of measurement greater than can be achieved by conventional optical metrology, or as a cross-check of conventional metrology. This will require use of a dedicated metrology beamline, one for soft X-rays and one for hard X-rays, as described below.
- **Support dedicated metrology beamlines for hard and soft X-rays.** Currently, a patchwork of facilities tests optics on beamlines. Many of these share time with user programs; others are not supported, and are used on an ad hoc basis, with the users providing the resources to staff and run the beamlines. This situation severely limits the character and depth of X-ray optics R&D that can be carried out.
  - **Reflectometry and scattering.** The most widely used at-wavelength testing involves measurement of the reflection, diffraction, and scattering from crystals, mirrors and gratings. This involves use of a multi-axis diffractometer, in air for the hard X-ray region, and in vacuum for soft X-rays.
  - **Imaging.** As well as the traditional diffractometry described above, the most demanding optics are now used for imaging, in particular nanofocusing. In this case, beamlines are needed for which wavefront-sensing techniques such as X-ray interferometry can be developed and characterized. Ultimately, we will need to correct wavefronts through the use of adaptive optics, and again, beamlines are needed that are equipped with wavefront sensors for the development of these techniques, before deployment of full systems to user beamlines.

### X-ray Shearing Interferometry: An Ultraprecise Way to Measure Figure Error

A shearing interferometer consists of a pointlike object, a surface to be tested, a shearing grating, and a CCD detector. The fringe pattern recorded on the CCD can be directly interpreted in terms of wavefront error.

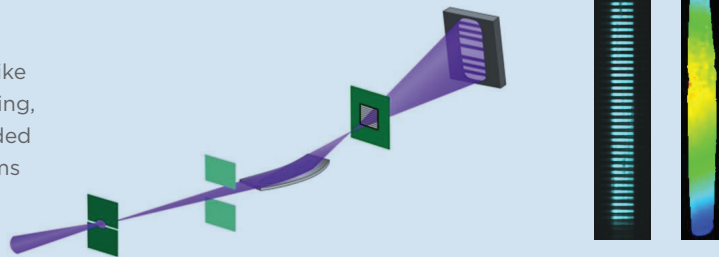

Slope error for an elliptical mirror with image and object distances of 0.12 m and 1.6 m, respectively, for a grazing angle of 8 milliradians. The central radius is around 30 m. Errors derived from the shearing interferometry measurement are shown in green and from an LTP measurement in red. The rms slope error in both cases is around 0.24  $\mu$ rads [7].

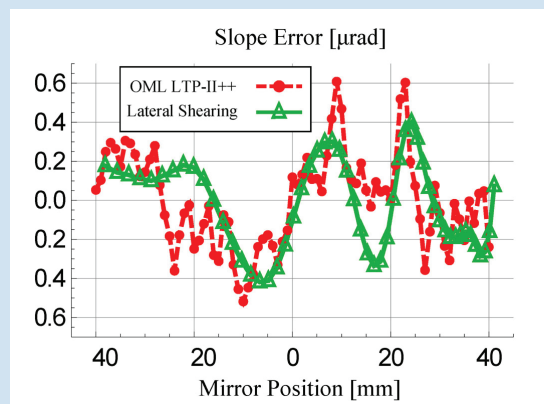



## We Need to Evaluate the Optical Characteristics of Components with X-rays

To measure characteristics such as X-ray reflectivity, scattering, and diffraction, it is important to use X-rays of the wavelength that will be used in final operation. For this, we need a combination of a dedicated beamline, such as the soft X-ray beamline 6.3.2 at the ALS, and a diffractometer. Similar systems are used for the testing of hard X-ray components.

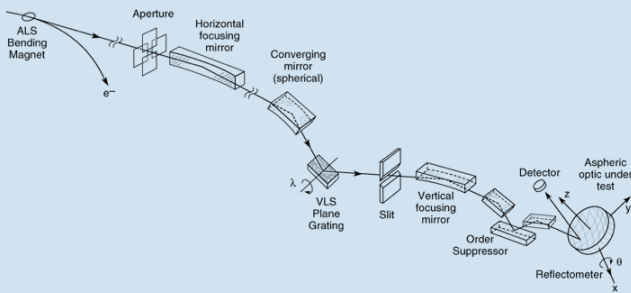

This multi-axis diffractometer [8] is used at soft X-ray wavelengths and therefore must operate in vacuum. As shown here, reflectivity and off-specular scattering measurements are to be performed on an aspheric multilayer optic used for EUV lithography.

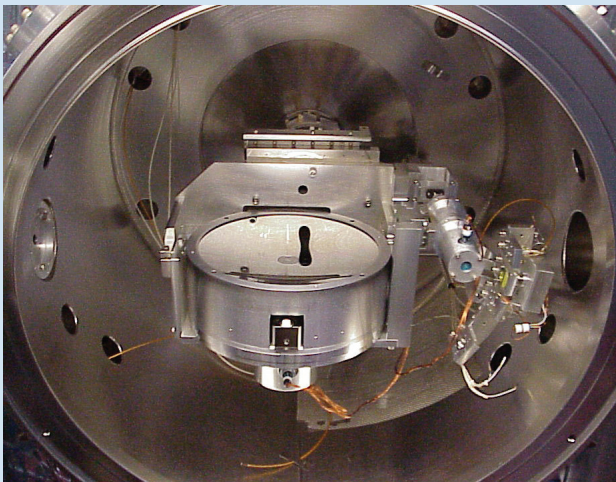

Although each laboratory needs a basic set of metrology tools, there is a great opportunity for specialization, so that costs can be shared. For example, development of a suite of at-wavelength tools could be undertaken by two laboratories, specializing in soft and hard X-ray tools, with deployment to all laboratories when completed. The same is true of advancing state-of-the-art laboratory-based metrology. A subset of groups could undertake this, with the product of the R&D deployed to all laboratories. Developments could be funded by a competitive proposal process to provide particular new tools. In other areas such as provision of metrology beamlines, direct and sustained funding is needed, particularly for staff to run these facilities. While of crucial use for X-ray optics R&D, these beamlines will have a broader impact, for example in the development and testing of new detectors.

## Impact

There are numerous ways to gauge the impact of investments in metrology on the performance of X-ray beamlines. Investments by the biological community in macromolecular crystallography (MX) have been substantial, allowing in many cases continuous upgrading of optical systems based on the increasing availability of higher-quality mirrors, better understanding of optical design, and our improved ability to diagnose where problems exist through investments in metrology — both in the beamline and in the laboratory. In-laboratory metrology has allowed us to optimally adjust mirrors and diagnose stability problems. It has also been extensively used to diagnose problems with mirrors that have been removed from a beamline after extended use. In-beamline metrology at several laboratories has been continually upgraded, enabling sophisticated evaluations of optical performance, allowing errors to be corrected and alignment to be perfected. As a result, many of these beamlines achieve a performance within 10–20% of theoretical values, as measured 20–50 m from the storage ring through a 50  $\mu\text{m}$  aperture. Stability at the level of a few percent over 24 hours can now be achieved. In progressing from the first third-generation beamlines to today's, several aspects of performance have increased by more than an order of magnitude. Such advances make once-impossible experiments relatively easy, such as microcrystallography on crystals of a few microns in size. In many other areas of X-ray optics, beamlines not as well-funded as MX beamlines suffer a performance substantially less than could theoretically be achieved. They are also not in a position to take advantage of sources' increasing brightness. Given the

very large cost of improving X-ray sources, modest investments in metrology can lead to large gains in performance, in some cases up to 2 orders of magnitude. Metrology can also enable new generations of experiments that require ultrahigh-accuracy optics, such as resonant inelastic X-ray scattering (RIXS), a technique set to revolutionize condensed-matter physics.

## References

1. P.Z. Takacs, *X-ray optics metrology*, Handbook of Optics, 3rd ed., Vol. V, M. Bass, Ed., Chapter 46, McGraw-Hill, New York, 2009.
2. P. Kirkpatrick and A.V. Baez, *Formation of optical images by X-rays*, J. Opt. Soc. Am. 38(9), 766-774, 1948.
3. P.Z. Takacs, Shinan Qian, and J. Colbert, *Design of a long trace surface profiler*, Proc. SPIE 749, 59-64, 1987.
4. F. Siewert, H. Lammert, and T. Zeschke, *The nanometer optical component measuring machine*, Modern Developments in X-ray and Neutron Optics, Springer, 2008.
5. V.V. Yashchuk et al., *Sub-microradian surface slope metrology with the ALS developmental long trace profiler*, Nucl. Instr. and Meth. A 616, 212-223, 2010.
6. V.V. Yashchuk, W.R. McKinney, and P.Z. Takacs, *Binary pseudorandom grating standard for calibration of surface profilometers*, Opt. Eng. 47(7), 073602-1-5, 2008.
7. D.J. Merthe et al., *Methodology for optimal in situ alignment and setting of bendable optics for nearly diffraction-limited focusing of soft x-rays*, Opt. Eng. 52(3), 033603-1-13, 2013.
8. <http://www-cxro.lbl.gov/beamlines/6.3.2>.
9. P. Mercère et al., *Hartmann wave-front measurement at 13.4 nm with Lamda EUV/120 accuracy*, Opt. Lett. 28(17): p. 1534-1536, 2003.

# Simulation and Modeling

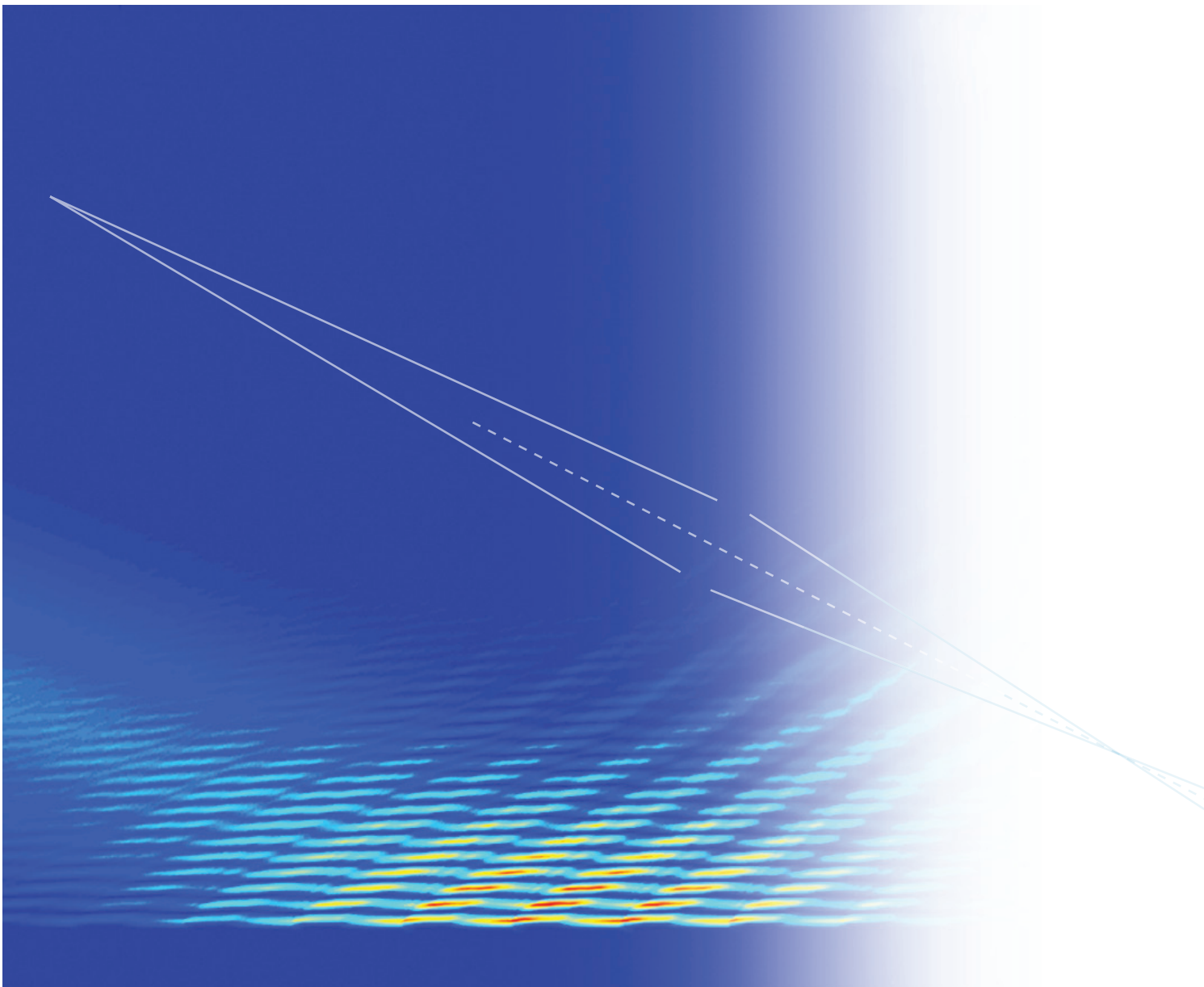

## Summary

Simulation and modeling should play a vital role in the design of X-ray optical systems, from the source to the experiment. Such simulations would allow us to design optical systems that are best for a particular application, model the effects of errors so that systems can be specified to the correct tolerance, understand the effects of errors that systems may suffer such as thermal distortion or misalignment, and understand the details of the photon field as it interacts with the sample and detector. Unfortunately, such types of simulations do not exist, or have been built up in an ad hoc manner for relatively narrow applications. This situation has existed throughout the history of synchrotron radiation research, starting with the geometrical optics code SHADOW developed by

Franco Cerrina's group at the University of Wisconsin. This has been one of the most widely used codes for simulation of beamline optical systems over the years, but it was never officially supported within the U.S. light source community. The development of this code therefore could not keep pace with the rapidly changing needs of the community as sources, optics, and experiments became more complex. Here we recommend a set of actions to remedy the situation, and to put theory and simulation on a proper footing to better support present and future needs.

### Working Group Chairs:

O. Chubar (BNL)

J. Krzywinski (SLAC)

### List of contributors in alphabetical order:

L. Assoufid (ANL)

Y. Chu (BNL)

R. Conley (ANL/BNL)

A. Fluerasu (BNL)

M. Idir (BNL)

K. Kaznatcheev (BNL)

D. Laundy (DLS, UK)

A. Mancuso (XFEL, Germany)

L. Poyneer (LLNL)

R. Reininger (ANL)

S. Hau-Riege (LLNL)

K. Sawhney (DLS)

L. Samoylova (XFEL, Germany)

D. Shapiro (LBNL)

J. Sutter (DLS, UK)

G. Williams (SLAC)

V. Yashchuk (LBNL)

### RECOMMENDATIONS

**1. Establish a framework for start-to-end simulations and inter-operation of different computer codes related to the development and use of current and future generations of X-ray light sources.**

The development of X-ray optical simulation methods and software should cover several types of experimental systems (such as the source within the accelerator, X-ray optical elements and systems, detectors, etc.) and requires expertise in various branches of physics. Only a broad approach can make possible detailed start-to-end simulation, including accurate representation of X-ray sources and optical elements, interaction of radiation with a sample, detector response, and tuning of experimental data-processing algorithms. Therefore special attention must be paid to establishing a common framework to ensure that different software tools, created by specialists from different areas, are compatible with one another in terms of approximations used, input/output data file formats, interfaces, and development platforms.

**2. Develop accurate physical-optics-based methods for detailed description of radiation propagation through and interaction with different types of X-ray optical elements and samples, and implement these methods in a reliable software.** Recent light-source development successes — such as the dramatic increase in brightness of new storage-ring sources and the emergence of X-ray free-electron lasers (FELs) — make it clear that the creation of nearly diffraction- and Fourier-limited X-ray beams, i.e., beams with characteristics limited only by the basic laws of physical optics, is possible. To ensure that the design and quality of X-ray optical elements allow for transport and manipulations with such beams without degrading their characteristics, the simulation should be based on accurate methods of physical optics.

3. **Improve overall efficiency and reliability of partially coherent emission and wavefront-propagation simulation methods and software tools for different types of sources.** The majority of the currently available X-ray sources produce partially coherent radiation, which is relatively difficult to simulate accurately, compared with the limiting cases of fully incoherent or fully coherent radiation. Nevertheless, without the accurate and CPU-efficient simulation of emission processes and propagation of such partially coherent radiation through optical systems of beamlines, neither adequate description of the current X-ray sources, optics, and experimental techniques; nor the R&D and future progress in these areas is possible.
4. **Develop libraries of functions for solving inverse problems in some experimental techniques, using the mathematical apparatus of physical optics.** Efficient solutions to inverse problems (i.e., data processing and interpretation) in some wave-optics-based experimental techniques (e.g., X-ray scattering, coherent diffraction imaging, phase retrieval) require numerical operations similar to those used for forward X-ray optical simulations. On the other hand, traditional applications of the forward simulations, such as X-ray source and optical element diagnostics and adjustment, can significantly benefit from coupling with reliable solvers of the inverse problems mentioned above. This argues in favor of a combined software development and integration of functions for both the forward simulation and the related inverse problem solution in common software libraries and packages.
5. **Software development efforts should be carried out across the whole community but tightly coordinated within an overall framework with defined leadership roles.** For initiating and efficiently pursuing the required software development in the directions listed above, based on the existing libraries and packages (such as SRW [1] and others), we recommend establishing a National Virtual Center with a lead institution, two regional leaders, and a set of participating laboratories. Participation by universities and industrial partners will of course be encouraged.

## Scope

The importance of X-ray optical simulations for applications of modern and future synchrotron radiation (SR) sources, including low-emittance storage rings, energy recovery linacs (ERLs), and FELs, can hardly be overestimated. X-ray radiation offered by modern sources is characterized by extremely high spectral brightness and flux, high repetition rates, and small transverse and longitudinal phase-space volumes occupied by the radiation pulses, which are in many cases limited only by the basic laws of wave optics.

To make sure that X-ray optical elements allow for the most efficient use of these ever-improving source characteristics, the simulations must be accurate and detailed. They should take into account all characteristics of the input synchrotron/FEL radiation, extending to the statistical and phase space properties of the electron bunches producing the radiation. The simulations must be based on the principles of physical optics, with the use of appropriate physical models for the optical elements, allowing for the detailed description of radiation propagation in media (i.e., inside the optical elements) and in free space.

Ideally, the simulation should not stop at the level of delivering X-ray radiation to a sample. It should also include, where possible, a model of interaction of the radiation with the sample, and further propagation of the scattered radiation to a detector, followed by the generation of detector signals (taking into account principles of operation of the detector and its basic characteristics: spatial resolution, spectral sensitivity, dynamic range, etc.). Furthermore, simulated detector data could be used to develop and tune experimental data-processing (reconstruction, analysis, etc.) algorithms. Such a complete start-to-end simulation chain would ensure the correct matching of different links in X-ray experimental setups: source, optics, sample, detector, and data processing. This would permit detailed planning of experiments, an adequate allocation and the most efficient use of resources and beam time (which is particularly important for X-ray FELs, where beam time is so scarce), and the correct interpretation of experimental results.

The simulations should support the development of scientific instruments and methods, including radiation sources, beamline optics, diagnostics tools, detectors, experimental techniques, and data-processing algorithms.

Of course not every experiment requires repeating all these simulations at a very high level of detail: For many classes of experiments, detailed simulations may be needed only at the stage of design and commissioning of beamlines and experimental stations. Nevertheless, the availability of consistent and compatible simulation tools and models for every constituent part of an experiment is absolutely crucial for the progress of science relying on future bright X-ray radiation sources.

## Issues

- **Need for physical optics tools.** General theoretical approaches and methods for X-ray simulations are known, and some of these methods have been implemented in computer programs. However in many cases, for different types of X-ray optics, efficient physical-optics computation algorithms still need to be developed, optimized, and implemented in reliable and user-friendly software tools. With the rise of highly coherent FEL sources, simulations of X-ray optics illuminated by fully or partially coherent beams have become highly desirable. These tools should be accessible to a wide population of users, not just code developers and experts.
- **Need for simulations to include imperfections.** Although not existing within a single framework, individual codes at the state of the art include essentially all the methods for simulating perfect mirrors and lenses; the treatment of realistic imperfections is, however, still under development. The same could be said regarding diffractive optics, gratings, and multilayer-based optics. Crystal optics is also often neglected in simulations, despite its high importance in SR beamlines. Algorithms for treating X-ray diffraction from perfect, bent, and distorted crystals already exist, but they have not come into widespread use due to lack of personnel with time and expertise to integrate them into a user-friendly software package. Such software would aid the task of beamline design for storage rings, ERL, and FEL sources. A very significant effort is needed to create element-specific simulation tools that include imperfections.
- **Need for common computational framework.** A common framework for X-ray data representation and exchange between software tools is currently missing. Often, scientists and engineers working on X-ray simulations in neighboring areas use strongly differing levels of approximations for sources, incompatible (and sometimes inconsistent) descriptions of partially coherent X-ray beams, incomplete descriptions of optical elements, etc. Any successful simulation framework must incorporate software interface layers to allow for an easy adaptation of these pre-existing physical models to its own generalized assumptions. For example, a modular simulation framework that defines a useful interface structure between modules could permit the swapping-out of matter-light interaction and light-propagation codes, as appropriate to the problem at hand. With such a complete tool set, facilities and light-source users alike will become motivated to provide modules supporting existing and new instrumentation as well as state-of-the-art models for the scattering of light by samples and detector response functions. This should benefit not only the users who implemented particular modules into the framework but also the entire user community.
- **Need for documentation and training.** As the scope of the computer programs grows, the existence of comprehensive documentation becomes essential to allow the programs to be used and the results correctly interpreted by scientists without extensive X-ray optics experience. The situation today is that tools are primarily used by tool developers or local experts, which severely limits their utility and slows overall development. Supported documentation and training are critically needed components. This will simply follow the lead of software provided by industry, where in the case of all sophisticated packages, Web-based documentation is available, and Web and on-site training are customary.
- **Need for coordination.** The situation with X-ray simulation tools can be significantly advanced by taking several coordinating (and consolidating) steps to target improvement of collaboration and communication channels between scientists and engineers working on different aspects of X-ray optics development. This includes technology, experimental techniques, theory, and software engineering. Compared with other topics and areas of X-ray optics R&D, development of simulation tools requires relatively modest financial investments. However, to be effective, work in this area should be carried out consistently over many years, with good coordination among laboratories, and with sufficient priority. A high-level priority is justified by the critical role that simulations play in the improvement of existing systems and in the development of next-generation X-ray facilities.

## R&D Directions for the Future

Below are the most important topics related to X-ray simulations and modeling, grouped by areas, starting from the framework for simulations by different computer codes, followed by details of simulation of the X-ray optical elements, partially coherent emission and wavefront propagation, and solvers of some inverse problems using the apparatus of physical optics.

- **Develop a framework for multistep start-to-end simulations and inter operation of different computer codes.** It is impossible to implement all varieties of numerical methods required for start-to-end simulations in one isolated computer program; therefore special attention should be paid to establishing a common framework, ensuring that different software tools created by specialists from different areas are compatible in terms of input/output data file formats, interfaces, and development platforms. The availability of such a framework would facilitate the use of software by large numbers of scientists and engineers from the communities of developers of X-ray sources and optics, as well as from the large community of X-ray users. Within this general area, we can now break this down into different subgroups.
  - **Develop a universal radiation and sample representation data format, e.g., based on the popular HDF5 file format, and implement support of this format in different simulation codes.** The adoption of a generic data format will facilitate the incorporation of data from multiple instruments and facilities into a single data-analysis work flow. For example, one might consider a two-part experiment where the sample is first probed by a microspectroscopy instrument with the best-available focusing optics and subsequently imaged with high resolution at another X-ray wavelength or via coherent imaging.
  - **Develop a dictionary for universal description of optical elements, allowing unambiguously defined parameters of an optical system. A defined system could then be studied by complementary simulation methods, without changing the optical system description.** For example, in a low-coherence case, there may be a need to perform initial simulation using fast geometrical ray tracing, and then, without changing definition of source and optical elements, run a CPU-intensive partially coherent simulation.
  - **Enable easy access to database applications as well as libraries of optical constants and characteristics of materials of interest in the construction of X-ray optical elements, including spectral reflectivity, refraction, absorption, basic crystallography data, etc.** These databases in general exist, but they are not accessible within a common framework that translates data into the form required.
  - **Work out general guidelines and recommendations for developing scientific software for X-ray optical simulation.** Such guidelines and recommendations can include suggestions for a preferable implementation of CPU-critical algorithms in C/C++, as libraries with documented application programming interfaces; and the use of a scripting environment for defining the entire simulation work flow. The scripting environment of choice would preferably be free and compact, such as Python, with the C/C++ libraries interfaced to it. A modular work-flow approach has many benefits for the end-user of the simulation tool set.
  - **Develop a common, powerful, user-friendly graphical user interface for X-ray optics simulations, ideally based on a free platform.** The use of a free, widely available, portable platform is required for maximum utility. An open-source environment like Python and its associated visualization modules, e.g., PyQt, wxPython, is a good compromise for meeting the needs of light sources and their users and ensuring widespread utilization. Nevertheless, the use of commercial multipurpose simulation packages with built-in scientific libraries and publication-ready graphics, such as MATLAB, IGOR Pro, IDL, or others, should not be excluded.
  - **Use and extend the existing open-source SR calculation, wave-optics, and geometrical ray-tracing simulation packages.** The open-source format is particularly efficient for collaborative software development by scientists and engineers who specialize in different areas and work at various laboratories, facilities, universities, and private companies. Existing software such as SRW [1], SHADOW [2], and McXtrace [3], which have benefited from many man-years of development, and in many cases have some of the required functions, offer a solid base for future major developments within the open-source format.

- **Use existing commercial optical simulation packages where possible.** Currently, a number of geometrical ray-tracing and even physical-optics-based commercial software packages are available on the market (e.g., Zemax, GLAD, VirtualLab/LabTrans). Existing commercial packages essentially address the needs of designers of visible-light optical systems, including systems for coherent laser beam applications. Even though these packages were not designed for X-ray applications, some of their features, e.g., Fourier-optics or beam-propagation functions, may be directly usable in X-ray optical simulations. These possibilities and the associated potential benefits for scientists and engineers should not be ignored, and some efforts should be dedicated to investigating modification of these codes with vendors for specific needs of SR X-ray optics.
- **Develop physical-optics-based methods for detailed simulation of radiation propagation through different types of X-ray optical elements and samples.** For a large number of optical systems, the propagation of radiation through the elements of an optical system can be described by applying a sequence of local transformations corresponding to the individual optical elements, to a function describing the radiation [4,5]. Therefore, the key parts of the mathematical and numerical description of X-ray beam propagation through a beamline from a source to a sample are the operations and methods describing the radiation propagation through individual optical elements. Such methods can differ in complexity and required CPU and memory resources, and can be grouped based on types of optical elements.

- **Diffractive and refractive X-ray optics, such as large-aperture zone plates, compound refractive lenses, kinoforms, etc.** In most cases, these types of optics can be approximated as thin optical elements that modify the amplitude and phase of the incoming electric field. Sometimes, as in the case of thick zone plates, more involved methods should be applied that describe beam propagation in inhomogeneous media. The development of efficient and versatile simulation software should aim to create a library of element-specific propagators. It is important to be able to model imperfections of such systems, such as slightly incorrect placement of zones or variations in zone width.

- **Grazing-incidence mirrors and adaptive optics, taking into account aberrations and imperfect surfaces, beyond the thin-optical-element approximation.** Imperfect, flat, or weakly focusing grazing-incidence mirrors can be modeled using the thin-optical-element approximation. However, this approximation does not work properly when the radius of curvature of the existing wavefront is comparable to the length of the grazing-incidence optic. An example of such optics is a Kirkpatrick-Baez (KB) mirror. The correct simulation of the influence of aberrations and imperfect surfaces is critical to predicting the intensity distribution in the focused beams. Accurate, efficient simulation tools that can address the described problem still need to be developed.

- **X-ray crystal-, grating-, and multilayer-based optics/monochromators.** X-ray crystal,

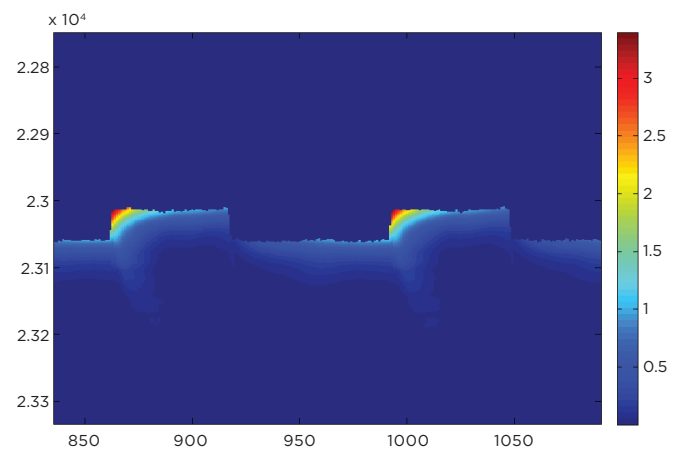
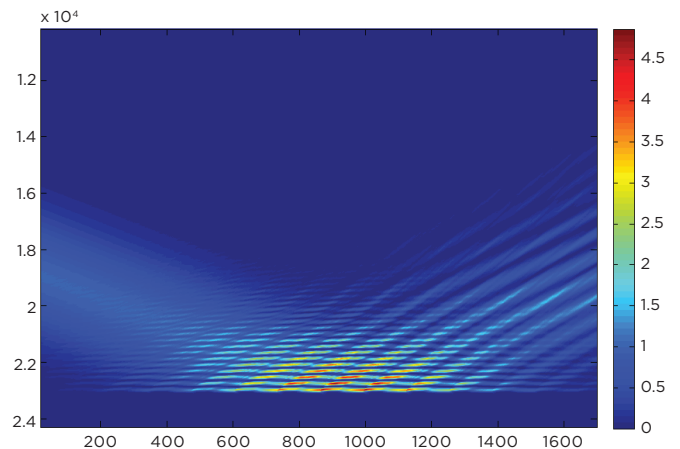

Simulation of FEL radiation interacting with a carbon-coated grating. **Top:** The plot shows the radiation intensity distribution close to the grating surface. **Bottom:** The plot illustrates the absorbed power distribution in the grating structure. The simulation includes the effect of surface imperfections measured by atomic-force microscopy.



grating- and multilayer-based optics are other types of elements for which specialized propagators should be developed. In many cases, questions of efficiency, frequency response, spectral resolution, etc., of these types of optics have been successfully addressed, and analytical or numerical solutions found and implemented in software tools. However, in most cases, the solutions are based on idealized assumptions, such as stationary, plane-wave excitations, or perfect geometries of optical components. There is a lack of CPU-efficient simulation tools that can model propagation of realistic X-ray beams through imperfect devices. Here, we should implement techniques that describe wavefront propagations in inhomogeneous media, beyond the paraxial approximation. The figure on the previous page shows an example of the application of such a method for simulating damage of a non-ideal grating exposed to intense FEL radiation [6]. In general, such simulations are computationally intense and will benefit from development of routines that take advantage of multinode distributed computing.

- **Imperfect optics using metrology data.** Simulation codes that use metrology data as input must be developed to adequately model the response of an optical system. Ray-tracing [2,3,7] or the wavefront propagation [1,8] codes are widely used in the X-ray optics community but are generally incapable of using metrology data. In particular, wavefront simulation is critical to predict the performance of optics for FEL and other ultimate diffraction-limited X-ray sources. Using metrology data within design codes will help optical designers predict with real measured data the performances of their designs and will allow for more accurate X-ray optics specifications, avoiding overspecification. Modeled perturbations should include such areas as time-dependent heat-load-induced distortion.

- **Improve efficiency and reliability of partially coherent emission and wavefront propagation simulations.**

Photon-hungry experiments have become increasingly common at light sources. Experiments that use imperfectly monochromatic and/or imperfectly transversely coherent X-rays are in increasing demand. With rare exception [9], simulation codes can deal only with completely incoherent or perfectly coherent beam properties. Providing fast and reliable predictions for partially coherent X-rays would fill an important gap. Properties of a photon beam at a sample depend on coherence of a source and characteristics and quality of optical elements used for the transport of the beam to the sample. Accurate calculation of characteristics of partially coherent radiation at a sample must cover both the processes of the radiation generation in a light source and its propagation through an optical system. In this section, we list the developments required in these two areas.

- **Increase efficiency and accuracy of the existing frequency- and time-domain near-field single-electron SR calculation methods for different types of magnetic field distributions, either simulated or resulting from magnetic measurements.** This type of computation is implemented in many codes. However, since it is often used and repeated a very large numbers of times in more complicated calculations, the efficiency of this basic type of calculation should be as high as possible. It should be robust and with good convergence for arbitrary distributions of 3-D magnetic fields, to accommodate, for example, magnetic-field imperfections of real insertion devices and development of new types of sources.
- **Develop efficient methods to calculate emission characteristics for different systems/ensembles of electrons in various regimes, including temporally incoherent and coherent spontaneous emission, self-amplified spontaneous emission (starting from noise or seeded), and others.** In different types of SR sources, we deal with emission from large ensembles of relativistic electrons. The resulting emission from such ensembles of electrons — spectral flux, brightness, degree of coherence — strongly depends on the dynamics of individual electrons and the degree of correlation between them. Detailed simulation of the emission from such ensembles can be quite complex and the efficiency of calculations needs to be significantly improved. Time-dependent FEL simulation codes, such as Genesis [11], made possible accurate simulation of SASE FEL radiation in periodic magnetic fields of undulators, and facilitated the detailed optimization and construction of X-ray FELs [12,13]. On the other hand, further improvement of the simulation methods used in these codes in terms of efficiency and limits of applicability (for different types of magnetic fields, with imperfections, various types of seeding radiation, etc.) will greatly help in performing start-to-end simulations for experiments.
- **Increase reliability and robustness of fully coherent wavefront-propagation methods, ensuring easy control and tuning of the required numerical sampling of the electric field in the coordinate/angle and**

**frequency/time representations.** CPU-efficient simulation of the propagation of a fully coherent wavefront through an optical system, for example using the numerical methods of Fourier optics [5], is central to many partially coherent wavefront-propagation simulation methods. The practical use of Fourier optics methods has some difficulties. For example, to obtain accurate results, one has to use not only a sufficient sampling to represent an input electric field, but also a large-enough range of the field definition, because this range will define the step size of the Fourier-transformed field. Therefore, a tool kit for manipulations with the 3-D electric field should include efficient functions for resampling and resizing the field in different representations. This should be done in an automatic manner, depending on properties of the input electric field and modeled optical elements.

- **Improve the efficiency and convergence of the partially coherent wavefront-propagation calculations for storage-ring sources using the coherent mode decomposition and/or improved Monte Carlo approaches for the integration over electron-beam phase-space volume.** Accurate partially coherent SR wavefront-propagation calculations are routinely performed for beamlines of the National Synchrotron Light Source II (NSLS-II) using SRW [9]. An example illustrating an almost complete start-to-end simulation, performed for the Coherent Hard X-ray (CHX) beamline of NSLS-II, is presented in the figures below. In the SRW code, a relatively simple calculation method is implemented for such simulations. In this method, no special preliminary analysis or decomposition of the input SR is required, and the accuracy of the final result depends essentially on the number of electrons, provided that the accuracy of simulating the propagation of the wavefronts from individual electrons is maintained at a sufficiently high level.

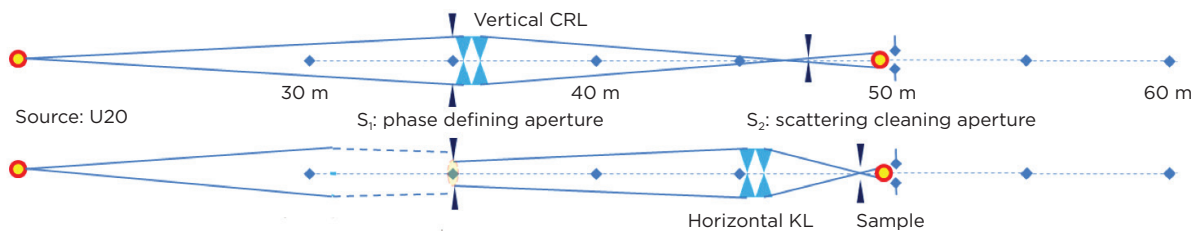

Simplified optical scheme of the undulator-based CHX beamline at NSLS-II in the vertical (upper part) and horizontal (lower part) planes. The scheme includes a U20 undulator, vertically focusing compound refractive lens (CRL), horizontally focusing kinoform lens (KL), several slits, and a sample.

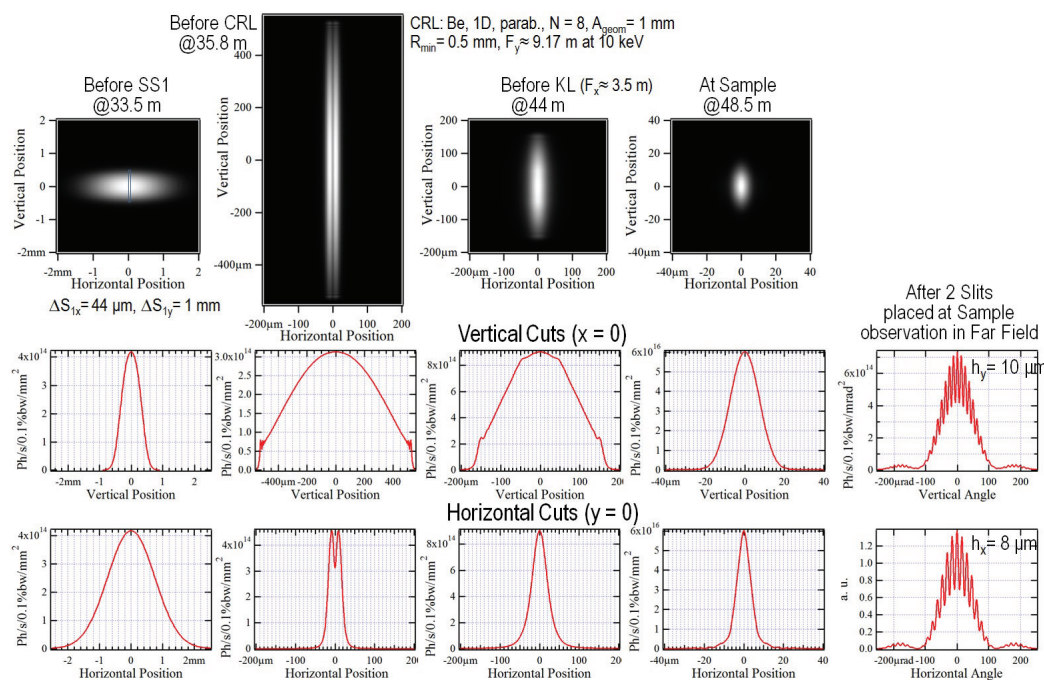

Intensity distributions at 10 keV photon energy calculated for different locations along the CHX beamline and in Young's 2-slit interference schemes with the slits located at the sample and observation taking place in the far field (graphs on the right).

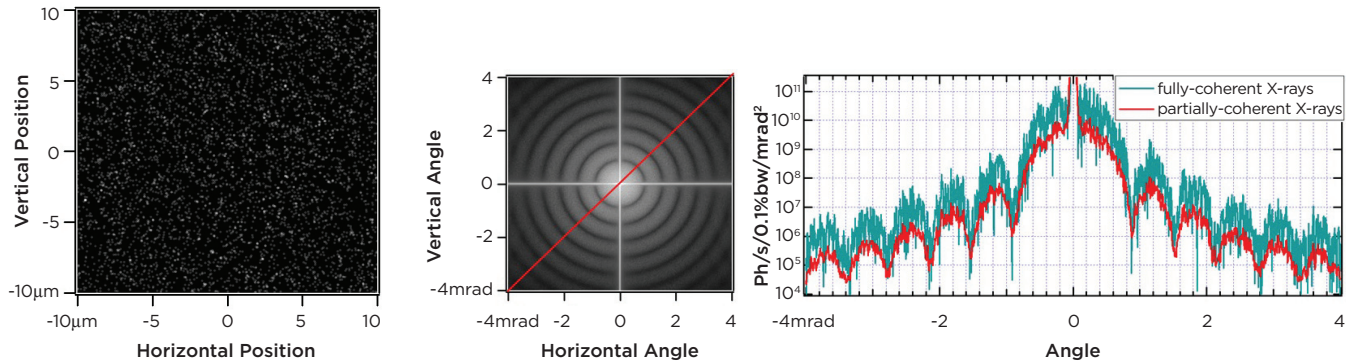

Simulated typical test sample colloid solution containing 5,000 200-nm-diameter silica particles (left), and the calculated angular distribution of 10 keV X-rays scattered by such sample at the CHX beamline (center and right). The speckle patterns of the scattered X-rays shown in the graph on the right were calculated for two different cases: illumination of the sample by fully coherent X-rays at the assumption of zero-emittance electron beam, and the illumination by partially coherent X-rays from finite-emittance electron beam for the parameters of optics and wavefront shapes shown in the previous figure.

Although calculation through systems as described here are relatively short (hours), the calculations can quickly become untenable for many cases of greater complexity or where the effects of perturbations need to be investigated, for example in the effect of deformed or misaligned optics. There are several ways in which the computation could be made more efficient, e.g., by using the coherent mode decomposition or improved Monte Carlo approaches; besides, it could be parallelized, or segmented to run on GPUs, for example in the calculation of Fast Fourier Transforms (FFTs).

- **Improve the efficiency of time-/frequency-dependent wavefront-propagation simulations for FEL (SASE, seeded, and oscillator-type)-related applications.** When performing simulations for the time-/frequency-dependent electric field of a 3-D FEL radiation pulse, it can be advantageous to minimize moves and copy operations of these radiation field data over the memory of one computer or across a network. Some algorithms, including the multidimensional FFT, allow for so-called in-place processing of data sampled on a multidimensional rectangular mesh. Such in-place operations can be successfully used for simulation of the propagation of 3-D FEL radiation pulses, allowing for entire wavefront-propagation simulation for one pulse to be performed within several tens of minutes even on a single-CPU computer [14].
- **Efficiently calculate sections of cross-spectral density (Wigner distribution) for the characterization of partially coherent SR/SASE wavefronts and for improving efficiency of the partially coherent wavefront-propagation simulations.** Potential advantages of performing partially coherent radiation-propagation simulations by making numerical manipulations with the cross-spectral density (mutual intensity) or its Fourier transform/Wigner distribution, which mathematically strictly defines the radiation brightness, were formulated some time ago [15]. However, since in the general case of a time-/frequency-dependent radiation pulse, these entities are functions of six variables (four in the case of monochromatic/steady-state simulations), the volumes of memory required for the efficient numerical manipulations with them can be too large even for modern computer systems. By considering different cross sections of the Wigner distribution, one can obtain at once a lot of very useful information about X-ray beam phase-space distribution and dynamics [16]. A lot of information is also carried by the degree of coherence function. The figure on the next page illustrates cross sections of this function for a partially coherent spontaneous undulator radiation beam. The simulation was made using a multinode computing cluster at the Diamond Light Source, UK. It demonstrates that in the horizontal direction, the radiation coherence is relatively low, but in the vertical direction, the coherence is high in the center of the wavefront, but depends on position. At the wavefront extremities, one can even observe fluctuations in the degree of coherence. Such diagrams provide explicit characterization of the wavefront coherence. Increasing numerical efficiency of this type of calculation is therefore very important and may help to increase considerably the general efficiency of partially coherent wavefront propagation simulations.

- **Develop libraries of functions for solving inverse problems/data processing for various applications and experimental methods, using the mathematical apparatus of physical optics.** The results of developments of forward X-ray propagation simulation methods and software can significantly facilitate the numerical solution of various types of related inverse problems, for example in data processing, in which some experimental techniques employ physical-optics-based propagators, and in diagnostics of X-ray sources and optical elements. Moreover, application of forward simulations to solving diagnostics-related inverse problems can greatly help in benchmarking the accuracy of the forward simulation methods and computer codes. Therefore, it seems natural to pursue software development in these neighboring areas. Possible directions of such synergetic developments are listed below.

- **Include in situ/at-wavelength metrology and analysis of optical element quality.** Many known at-wavelength X-ray optical metrology schemes, and in particular mirror metrology, could potentially be further improved in terms of efficiency and flexibility by detailed forward wavefront-propagation simulations. Such simulations allow for establishing clear quantitative dependences and links between optical element imperfections and radiation characteristics to be measured in particular optical schemes and coherence conditions. Based on this, efficient algorithms could be developed for solving the corresponding inverse problem, where optical imperfections would be calculated based on the measured radiation characteristics. In the process of such development, the same software bricks and library functions used for the forward simulations could be effectively applied.

- **Develop efficient correction and optimization algorithms for adaptive optics.** Adaptive optics, aiming to deliver X-ray beams with a required shape or phase characteristic or to compensate for existing aberrations created by other optics, particularly benefit from forward wavefront-propagation simulations and the development of efficient inverse problem solvers. Such solvers would guide or even automatically control the adaptive optics actuators based on a required beam shape, phase distribution, or compensation.

- **Extensively use general numerical optimization methods to solve inverse problems related to source and optical element diagnostics, experimental data processing, and interpretation.** A popular application of X-ray optical simulations for light sources is the prediction of performance characteristics of beamlines and instruments, and comparison of the predicted characteristics with actual measurements when the instruments are realized in practice. Very often, however, there are observed differences/discrepancies between the simulations and the measurements. In many cases, the only chance to understand the origin of such discrepancies is to address somehow the corresponding diagnostics problems — e.g., to perform multiple forward simulations for a range of parameters related to source and/or optical element characteristics or imperfections, attempting to find a set of parameter values providing a best fit of the simulations to the measurements. On the other hand, the parameter space is often so large that a good fit or agreement can be achieved only through a powerful automatic optimization procedure such as linear algebra, regularization, regression, or multiparametric and multiobjective deterministic and stochastic optimization (e.g., based on genetic algorithms). Adaptation of such existing methods and libraries for convenient and easy use with the forward simulations in one computing environment is therefore necessary and seems to be very beneficial.

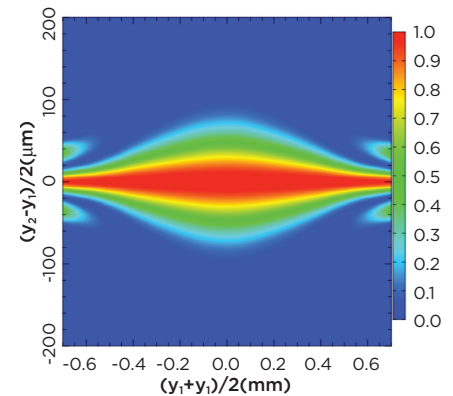
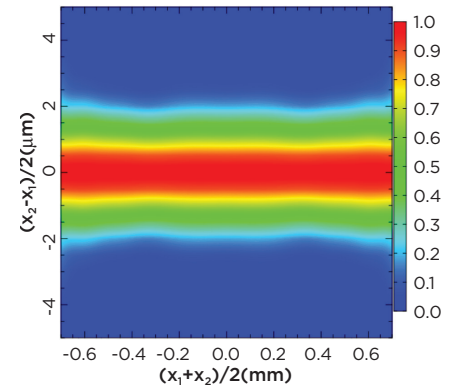

Absolute value of the degree of spatial coherence at 5.305 keV photon energy, calculated for Diamond Light Source undulator beamline I13. The calculation is for points separated in the horizontal direction from the center of the undulator cone (top) and in the vertical direction (bottom).

## Impact

If implemented in full scope using reliable and user-friendly software, the developments described above will enable a huge step forward in our ability to reliably design X-ray optical systems in general, and provide a way to completely optimize an experiment from source to detector. In particular, these developments will:

- Ensure optimal design of beamlines for different types of experiments involving X-ray sources
- Facilitate creation of new types of high-resolution and high-throughput X-ray optical elements, taking into account special features of modern and future sources (high brightness, coherence, short pulses, etc.)
- Allow for better optimization of in situ optical metrology schemes and methods, improving their accuracy and reliability, and making them more easily adaptable to different types of beamlines and optical elements
- Help in identifying and designing critical beam diagnostics, both for pulse-by-pulse measurements and for characterizing the coherence properties of the X-ray beam
- Enable interpretation and analysis of diagnostic data to give information on the performance of the source and optical system
- Provide the possibility of comparing real performances of user beamlines with simulations, and determining, localizing, and eventually eliminating factors limiting these performances (e.g., related to electron beam instabilities, quality of magnetic fields in insertion devices, quality of beamline optical elements, thermal deformations, vibrations, etc.)
- Allow for start-to-end simulations of experiments involving SR sources, including accurate calculation of input radiation, wavefront propagation through a beamline, simulation of expected interactions of a sample with an X-ray beam, and modeling detector signals. This will help in assessing feasibility of experiments, and allow for optimization of experimental setups and most efficient use of beam time.
- Help to develop new and extend existing experimental techniques and data-processing algorithms to better exploit available properties of sources (e.g., extension of coherent diffraction imaging and phase retrieval techniques that work not only in full, but also in partial coherence conditions, profiting from higher flux and smaller exposure times)

Compared with other parts of SR source development, instrumentation, and science, investment in simulation and modeling doesn't involve expensive hardware, and a comprehensive plan as outlined above could be executed for a modest investment. This is an area that has been neglected in the past, slipping between the design and construction of the source and the beamlines. However, with the present ultrabright sources, and new even brighter machines on the horizon, simulation and modeling could have an enormous impact on our ability to use every photon in the most effective manner, for the great benefit of the scientific community using our facilities.

## References

1. O. Chubar and P. Elleaume, *Accurate and efficient computation of synchrotron radiation in the near field region*, Proc. of EPAC-98, 1177-1179, 1998. O. Chubar et al., *Physical optics computer code optimized for synchrotron radiation*, Proc. SPIE 4769, 145-151, 2002.
2. M. Sanchez del Rio et al., *SHADOW3: a new version of the synchrotron X-ray optics modeling package*, J. Synchrotron Rad. 18, 708-716, 2011.
3. E. Knudsen et al., *A Monte Carlo approach for simulating the propagation of partially coherent X-ray beams*, Proc. SPIE 8141, 814108, 2011.
4. J.D. Jackson, "Classical Electrodynamics," John Wiley & Sons, 3rd ed., 1998.
5. J.W. Goodman, "Introduction to Fourier Optics," Roberts & Company, 3rd ed., 2005.
6. J. Gaudin et al., *Investigating the Interaction of X-ray free electron laser with grating structure*, Optics Letters 37, 3033, 2012.
7. F. Schaefer, *Ray - the BESSY raytrace program to calculate synchrotron radiation beamlines*, Technischer Bericht, BESST TB 202, 1-37, 1996.
8. J. Bahrtdt, *Wave-front propagation: Design code for synchrotron radiation beam lines*, Applied Optics 36(19), 4367-4381, 1997.
9. O. Chubar et al., *Application of partially coherent wavefront propagation calculations for design of coherence-preserving synchrotron radiation beamlines*, Nucl. Instr. and Meth. A649, 118-122, 2011. O. Chubar et al., *Development of partially coherent wavefront propagation simulation methods for 3rd and 4th generation synchrotron radiation sources*, Proc. SPIE 8141, 814107, 2011.
10. T. Tanaka and K. Kitamura, *SPECTRA: A synchrotron radiation calculation code*, J. Synchrotron Rad. 8, 1221-1228, 2001.
11. S. Reiche, *GENESIS 1.3: a fully 3D time-dependent FEL simulation code*, Nucl. Instrum. and Methods A 429, 243-248, 1999.
12. P. Emma et. al., *First lasing and operation of an ångstrom-wavelength free-electron laser*, Nature Photonics 4, 641-647, 2010.
13. T. Ishikawa et. al., *A compact X-ray free-electron laser emitting in the sub-ångstrom region*, Nature Photonics 6, 540-544, 2012.
14. O.Chubar et. al., *Time-dependent FEL wavefront propagation calculations: Fourier optics approach*, Nucl. Instrum. and Methods A593, 30-34, 2008.
15. K.-J. Kim, *Brightness, coherence and propagation characteristics of synchrotron radiation*, Nucl. Instrum. and Methods A 246, 71-76, 1986.
16. I. Bazarov, *Synchrotron radiation representation in phase space*, Phys. Rev. ST Accel. Beams 15, 050703, 2012.

# Nanodiffractive Optics

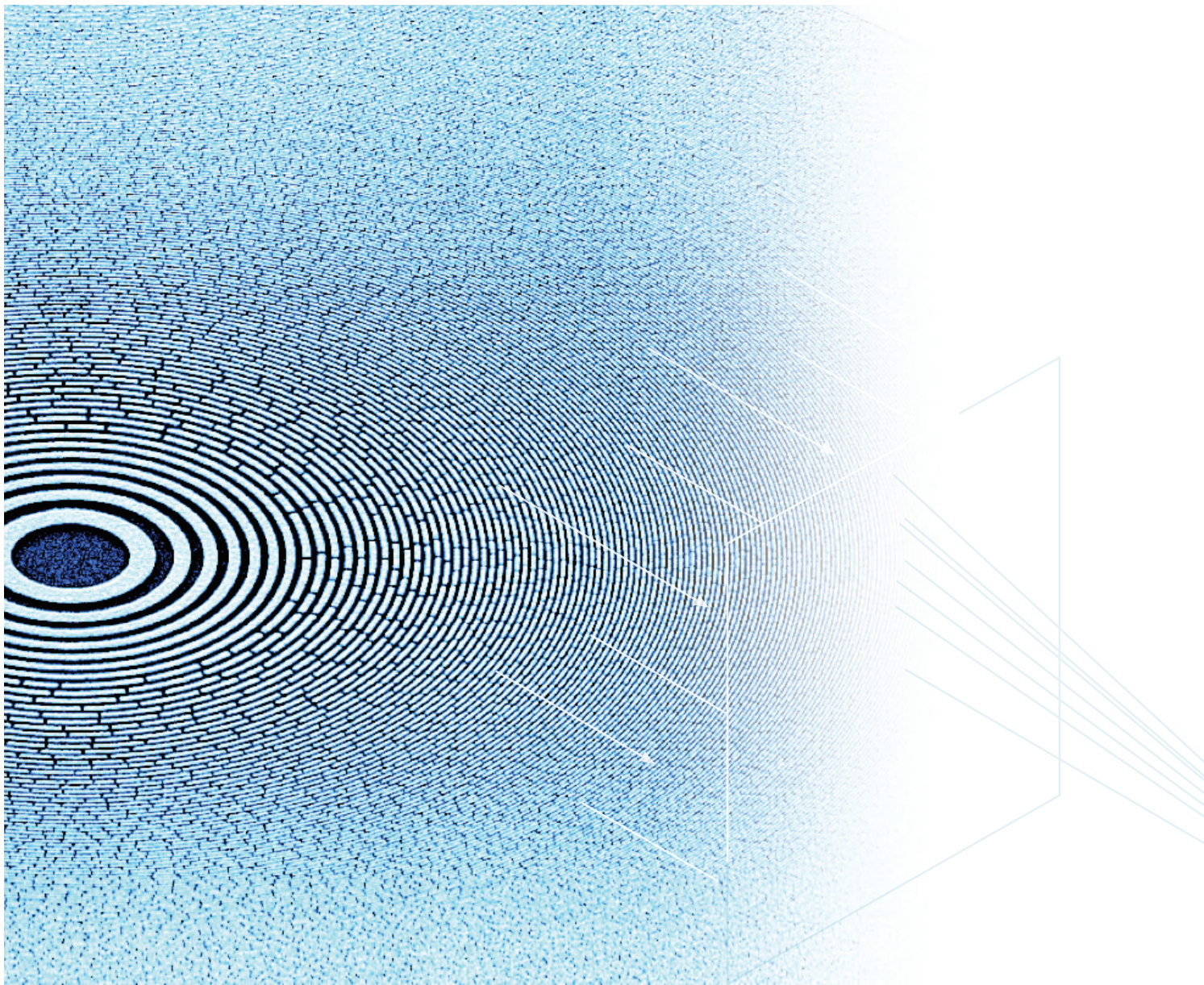

## Summary

Zone-plate microscopes play a crucial role in various critical science areas such as energy storage, catalysis, photovoltaics, energy conversion, and unconventional oil recovery. While these microscopes have been central to numerous breakthroughs over the past two decades, many scientific challenges remain just beyond the reach of this technique because of present resolution and efficiency limits. In practice, current microscopes are limited to practical resolutions of 15-20 nm in the soft X-ray range and 50-70 nm in the hard X-ray range. Pushing resolutions to the 5-10 nm range will have dramatic new impacts on science and technology and provide unprecedented views into mesoscale systems.

### Working Group Chairs:

P. Naulleau (LBNL)  
S. Vogt (ANL)

### List of contributors in alphabetical order:

E. Anderson (LBNL)  
Y. Chu (BNL)  
R. Conley (ANL/BNL)  
C. David (PSI)  
M. Feser (Xradia)  
P. Fischer (LBNL)  
R. Heilmann (MIT)  
C. Jacobsen (ANL)  
G. Schneider (Helmholtz  
Institute Berlin)  
D. Shapiro (LBNL)  
W. Yun (Xradia)

Zone-plate **resolution and efficiency** are clearly defined as the highest-priority items for zone-plate development. Pushing zone-plate resolution will allow us to achieve fundamental materials length scales. Moreover, efficiency improvements are essential to achieving the throughput and signal-to-noise ratio required to enable statistically relevant scientific research. Resolution and sensitivity are inexorably linked, and as such must be treated as a single priority. This statement is true for both the soft and hard X-ray regimes. To address current limitations, various potential fabrication solutions have been identified. These solutions are complementary; achieving resolution and efficiency goals will likely require combining multiple approaches, including lithography, atomic layer deposition, etching, and stacking.

Free electron lasers (FELs) of unprecedented brightness have already arrived and are allowing examination of processes on the fsec timescale. Storage-ring technology is also advancing, and a new generation of quasi CW diffraction-limited storage rings with up to 3 orders of magnitude higher brightness than the current third-generation machines is on the horizon. These will be ideal sources for examination of noncrystalline materials at the nm level, but to do so, we need a new generation of focusing elements based on nanodiffractive structures to take advantage of this extreme brightness. To address the needs in these areas, we make the following recommendations for future investments in nanodiffractive optics research.

### RECOMMENDATIONS

- 1. Resolution of zone plates should be improved.** Zone-plate resolution is limited by the width of the outer zone. State-of-the-art nanopatterning can achieve close to 10-nm zone width. To go beyond this requires the development of a combination of techniques based on double patterning and frequency multiplication, for example, through the use of atomic layer deposition (ALD) conformal coating
- 2. Improve the efficiency of zone plates.** Zone-plate efficiency is limited by thickness, type of material, and the shape of each zone. Effective thickness could be increased by a number of techniques such as stacking of aligned structures. Most zone plates are binary structures, but large efficiency increases can be gained by making multilevel structures that are approximations to blazed profiles.



- 3. Increase the size of zone plates.** Zone-plate diameters of 200  $\mu\text{m}$  or more offer improved working distance in soft X-ray microscopes, and a good match to illumination beams in hard X-ray microscopes. Two approaches look promising to address this concern. First, write speed could be improved using more sensitive photoresists, employing technologies that are under development for extreme ultraviolet (EUV) lithography. A second approach is to tolerate long write times and low yield with conventional lithography, and pattern-replicate using nano-imprint lithography.

## Scope

Optics to focus neutral particles are a critical component in all high-brightness X-ray and neutron sources for beam conditioning, focusing, and image formation. In particular, diffractive optics and nanostructures such as Fresnel zone plates and gratings play a critical role in instrumentation at current and future light sources. Such optics are indispensable in X-ray instrumentation involving imaging, microscopy, and light dispersion. The combination of nanoscience and ultrafast sources drives resolution and efficiency requirements for X-ray optics and so the need for diffractive optics is growing as new and brighter light sources come online.

Fresnel zone-plate lenses have been used for over a century. The first demonstration (reported by Wood but unpublished) was by Lord Rayleigh in 1871, followed by the published work of J.L. Soret in 1875 [1]. Albert Baez proposed the use of zone plates to focus EUV and soft X-ray light in 1960-61 and demonstrated their properties in the UV [2,3]. In the late 1970s and 1980s, zone plates and coded apertures saw extensive use for plasma diagnostics. During this same time, the era of nanofabrication arose with the development of electron beam lithography. It was quickly realized that nanofabrication techniques provided a perfect pathway to improved diffractive optics for use in the X-ray regime. This idea was first proposed by David Sayre at the IBM T.J. Watson Research Laboratory [4]. Zone plates have since been continuously developed for many different applications with ever-increasing resolution [5,6,7,8,9]. As one might expect, the primary driver for advanced zone-plate optics is X-ray microscopy [10], which has become a proven and powerful scientific technique around the world. Every DOE light source has numerous microscopes using zone plates. These microscopes have played essential roles in fundamental learning and advancements in nanomagnetism, material science, polymers and soft materials [11,12,13], environmental science [14], and life science [15].

In addition to zone plates, a wide variety of other nanodiffractive structures play crucial roles in X-ray science. Examples of such structures include resolution and calibration standards that are needed to ensure beamlines and instruments perform properly. Beamline diagnostics based on shearing and/or point diffraction interferometry use nanostructures such as gratings, pinholes, structured illumination optics, and coded apertures. Illumination-control systems for both improved uniformity and coherence manipulation have relied on engineered nano-roughness surfaces and nanopatterned computer-generated holograms. Material-characterization instruments have included special differential interference optics, and coherence diagnostics have included uniformly redundant aperture arrays and nanoscale pinholes in semitransparent membranes. Spectral filtering methods have employed 3-D nanopatterned blazed gratings.

In addition to nanofabricated diffractive optics, there is a class of optics fabricated by way of deposition processes. One of the most promising is known as the multilayer Laue lens (MLL) [16]. Such optics are suitable primarily for nanoprobes operating at single energies and narrow bandwidth at X-ray energies above  $\sim 10$  keV, yet provide complementary capabilities compared with nanofabricated optics. Although conceptually equivalent in that these optics image by way of diffraction, MLLs are not covered in the scope of this chapter, which we have limited to optical elements fabricated through lithographic processes.

## Issues

Advancements in storage-ring technology have increased brightness by approximately 3 orders of magnitude for each generation of machine. Each increase in brightness has been primarily used to enhance our ability to carry out X-ray microscopy of some form, and many or most of these microscopes use diffractive optics as the

focusing element. This trend is continuing, with the development of “diffraction limited” storage rings, such as MAX IV, which will have full transverse coherence throughout most of the soft X-ray region. Planning is under way for similar advances in both the soft and hard X-ray regime for several machines around the world. The advent of these ultrabright machines, with a brightness up to 3 orders higher than the current generation of storage rings, again drives the need for better-focusing optics that can extend resolution into the nm regime. Here we outline the main issues that we face.

- **Resolution.** The imaging resolution of a diffractive optic is limited by the structure sizes in the diffractive element itself. As a rule of thumb, the imaging resolution limit is equal to the smallest feature size (or the width of the outermost zone) in the diffractive optic. This reality is independent of wavelength. Thus, to achieve single-digit nm imaging resolution with diffractive optics, one needs to pattern single-digit nm structures.

### Zone Plates Are Convergent Circular Diffraction Gratings That Focus Light

Pictorial diagram of a zone plate showing closed and open zones and the change in path-length by integer wavelengths from one open zone to the next. The spot size in the focus is approximately the width of the outermost open zone. The focal length is given by the product of the lens diameter and outer zone width divided by the wavelength. Long focal lengths, desirable for in situ experiments, require a large diameter and large number of zones.

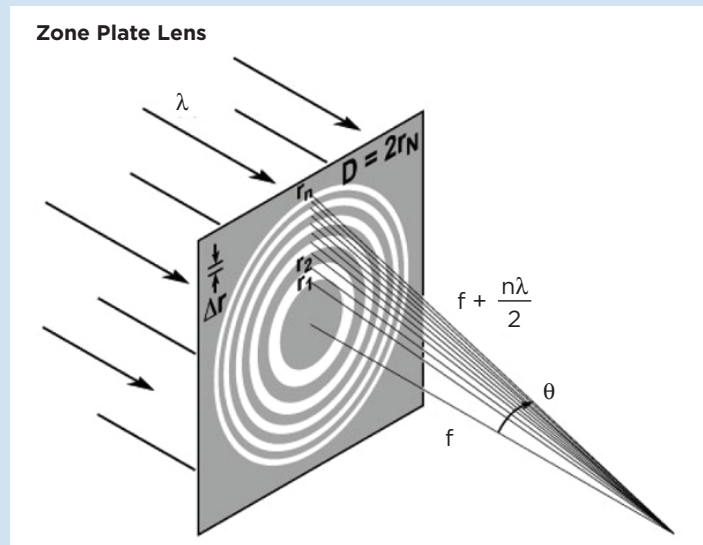

A micro zone plate. The metal used for the closed zone must be thick enough to fully absorb incident radiation, or cause a  $\pi$  phase shift. As the spot size required decreases, the outer zone must be commensurately smaller, and hence the aspect ratio of thickness to width increases. This becomes problematic for very high resolution ( $<10$  nm) and for hard X-rays.

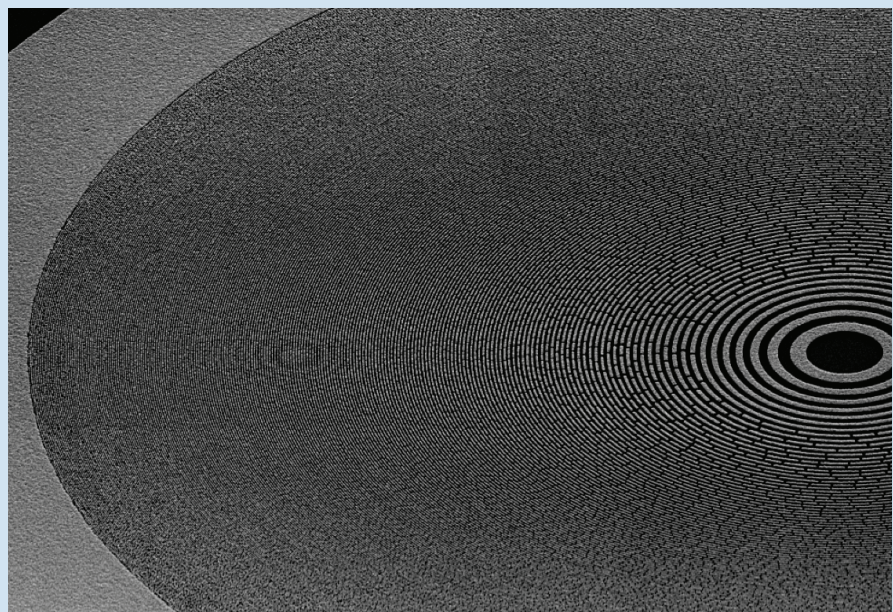

Pushing diffractive optics into the single-digit-nm resolution regime remains a daunting challenge. At these levels, we are simultaneously approaching several limits, including beam size of even Gaussian e-beam tools, electron scattering within the photoresist and substrate, materials resolution within the photoresist, and resist mechanical leading to pattern collapse.

Moreover, the resolution question cannot be divorced from efficiency issues, even though we have somewhat arbitrarily separated these two issues in the discussion to follow. It is evident that lacking any constraints on structure thickness, single-digit-nm structures can be fabricated, but with vanishingly small efficiencies. Thus, it should be understood that when we refer to resolution, we further imply a workable efficiency that involves ca. 0.1  $\mu\text{m}$  thicknesses for soft X-ray applications and ca. 1  $\mu\text{m}$  thicknesses for hard X-ray applications.

We also note that directly connected to resolution is the numerical aperture (NA) of zone plates, which is inversely proportional to the zone width if used in first-order diffraction. For full-field imaging systems using laboratory X-ray sources, it is advantageous to use the highest-NA zone plates available, since the photon collection from the source is proportional to the square of the NA. Often in these applications the zone plate does not operate at the diffraction limit, but provides much higher X-ray flux than a lower NA zone plate. Thus, in this case, a feature that is typically associated with resolution (the outer zone width limit) actually most directly impacts total system efficiency.

- Efficiency.** As suggested above, efficiency remains an equally important limitation in modern zone plates. There are ample cases where researchers consider the efficiency limitations even for moderate-resolution zone plates to be the biggest inhibitor to scientific progress with nanodiffractive methods; this becomes particularly true in the hard X-ray range. Efficiency is largely constrained by the aspect ratio of the diffractive structures we are able to fabricate. This is especially relevant for the hard X-ray regime as well as for systems based on lab-scale sources such as those most relevant to industry. The efficiency of a diffractive optic is determined by the optical contrast of the diffractive structure, which ideally is strongly absorbing or can provide a phase shift of close to  $\pi$ . As materials become more transparent at harder X-rays, achieving adequate absorption or phase shift demands increased thickness and thus larger aspect ratios. Ideally, one would like to get to structure thicknesses of for example 1.6- $\mu\text{m}$  at 8 keV and even thicker for harder X-rays. At 20-nm zone width, this would correspond to an aspect ratio of 80:1, well beyond current capabilities.

Acceptable efficiencies may also depend strongly on the application. For direct imaging of radiation hard samples in a full-field microscope setup, small efficiencies may be an acceptable trade-off to achieve the best-possible spatial resolution. However, the signal-to-background ratio becomes worse when compromises are made on the efficiency of the zone plate, since the background due to scattered X-rays or other parasitic sources is typically independent of the efficiency of the zone plate. Therefore, for low signal-to-noise applications, a high efficiency is preferred.

The concept of efficiency therefore cannot be decoupled from resolution. The real challenge is combining both efficiency and resolution. As a corollary to the statement that we could fabricate single-digit-nm structures if efficiency was of no concern, from the efficiency perspective, it is evident that if resolution was really not a concern we could certainly fabricate very thick and high-aspect-ratio structures. Presently, even at modest hard X-ray energies  $\sim 10\text{keV}$ , performance is lacking even at 50-nm dimensions.

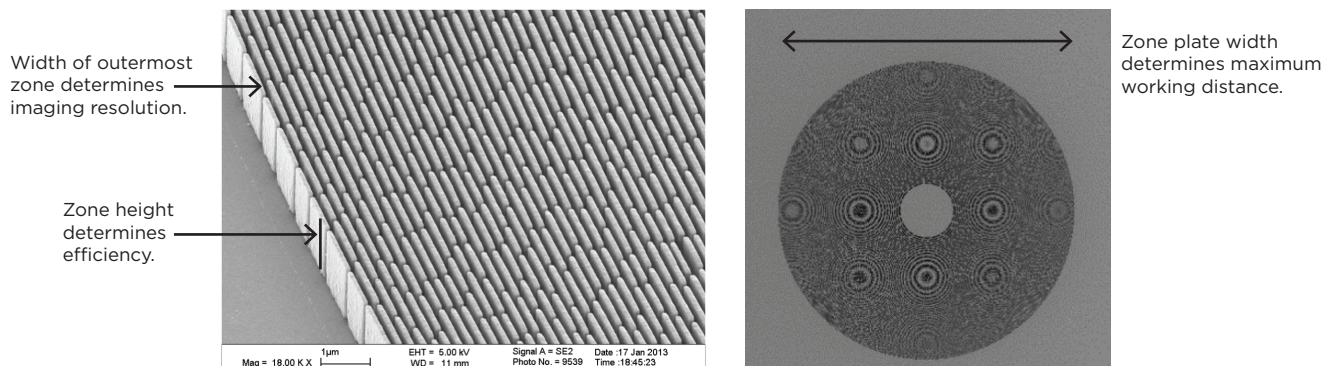

- **Size.** Another concern for zone plates is size. Large-diameter zone plates are required for longer working distances, in particular in the soft X-ray energy range. Long working distances enable crucial flexibility in sample environments as well as tomography. Such flexibility is essential in the practical use of these devices to solve real-world science problems. New methods are needed to enable large-diameter zone plates with resolutions of 20 nm and beyond. It is important to point out that such conditions may require much-improved spectral filtering to avoid chromatic degradation of the point-spread function.

Large zone plates also play an essential role in system efficiency for certain classes of full-field microscopes using condenser zone plates. Moreover, larger condenser zone plates imply larger numerical apertures and thus better matching to the imaging zone plate and ultimately higher functional resolution. We note that condenser fabrication limitations often have more to do with write-time constraints than patterning resolution limitations. The required write time is directly proportional to photoresist sensitivity. Current constraints limit us to approximately 30-nm outer zone width condensers.

The size issue is also the dominant limitation in applying lithographic fabrication methods to gratings. In this case, however, resolution relative to modern capabilities is not really an issue. Here, partnerships should be sought with the mask-making industry to explore the use of mask-making tools for the fabrication of synchrotron gratings.

- **Radiation damage.** Another area of concern relates to radiation damage to zone-plate optics during routine use. Typical radiation-related damage can be either indirect, i.e., environmentally related, or direct. Examples of indirect damage include carbon contamination as well as chemical modification and damage to either the base or the structure of the zone plate due to interactions between radiation-created ions/radicals and construction material of the zone plate. With hard X-rays in particular comes the potential for direct damage through the energy deposited by absorbed X-rays, e.g., sputtering.

For hard X-rays, carbonaceous deposits generally do not impact the performance due to the high transmission through carbon. Hard X-ray diffractive optics typically have higher aspect ratios, making these structures more susceptible to mechanical collapse in the fine structures. Known causes are the chemical changes in the materials making up the zone plate caused by humidity, oxygen radicals, and the interaction with X-rays themselves (e.g., leftover photoresist will bubble if exposed to X-rays). Stabilization techniques include conformal coatings and operation in an inert atmosphere or vacuum.

Properly fabricated and used zone plates currently last for sufficiently long times at typical operating conditions at synchrotrons (many months to years), but the future development of higher-resolution, higher-aspect-ratio zone plates will likely make them more susceptible to damage. This is especially true if newer exotic materials will be employed — for example in an effort to improve efficiency — that might have poorly understood degradation mechanisms. In new developments it is important not to degrade the lifetime of diffractive optics and to test the stability of new materials and structures in the relevant environment, including X-ray dosing early in the process to ensure practical usability.

Radiation damage issues in FELs are different in nature from those in synchrotrons due to the extremely high-peak-power densities encountered, which lead to ablation and thermal failures (melting). This type of optics requires special design considerations such as fabrication in a weak-absorption, high-thermal-conductivity material.

- **Infrastructure.** One of the most important issues in nanopatterned gratings is infrastructure. The Gaussian e-beam tools typically used for the fabrication of diffractive optics are far too slow for large area gratings. In the semiconductor mask industry, however, suitable capabilities exist in terms of patterning speeds both in the form of shaped beam tools (e-beam) and laser writers. These tools, however, are only configured for standard semiconductor mask formats (6-inch square, 1/4-inch thick). Reconfiguring such tools does not appear to be a fundamental limitation. In addition to dealing with large area gratings, it is also evident that shaped beam e-beam tools could have significant impact on condenser write times, but this is not a complete solution, as such tools are somewhat resolution-limited compared with Gaussian beam tools. In addition to the challenges of writing large area structures, we need a robust infrastructure to develop the latest techniques in ultra-high-resolution patterning. This requires not only the development of writing techniques, but primarily development of new methods in the use of ultra-high-resolution resists and pattern-transfer

methods. Unlike nanocenters that service a large nanoscience community, the tools and techniques needed for nanodiffractive optics are highly specialized and optimized for the manufacture of optics. The facilities for developing nanodiffractive optics and supplying them to the user community exists within the DOE infrastructure, but a robust framework is needed to fund this vital area for both R&D and production.

Many scientific areas suffer because of the problems outlined above. Zone plates are the key element in transmission X-ray microscopes (TXMs) and scanning TXMs (STXMs). These types of microscopes are very widely used across a broad range of science, from probing the dynamics of magnetic switching in magnetic thin films using X-ray magnetic circular dichroism (XMCD)-TXM to examining the chemical state of toxic elements in soil using X-ray absorption spectroscopy (XAS)-STXM before and after remediation. Although these microscopes provide tremendously useful information, their resolution is becoming mismatched to some of the key needs of BES energy science programs. For example, in energy storage, key questions exist about the process of lithiation of  $\text{FePO}_4$  and the structure of the solid-electrolyte interface in lithium ion batteries. To probe these processes, however, really requires a few-nm resolution. The same is true in areas such as photocatalysis, where formation of few-nm clusters and networks of materials such as  $\text{Fe}_2\text{O}_3$  are key to high catalytic activity, and in self-assembled polymer structures used as porous membranes in fuel cells. The development of nanodiffractive optics with resolution in the few-nm regime should have a dramatic effect on our ability to understand the functioning of nanomaterials, and nanomaterials assembled into complex hierarchically ordered structures. With advances in lithography driven by the semiconductor industry, together with new generations of ultrabright X-ray sources on the horizon, we are close to achieving our goal of nm-resolution X-ray microscopy.

## R&D Directions for the Future

In this section, we present the most promising research areas for addressing current zone-plate resolution and efficiency limitations. Again, although we somewhat arbitrarily separately address resolution and efficiency, the two attributes are in fact inexorably linked. It is also important to note that the development paths described below are not mutually exclusive; they are completely complementary. Ultimately, pushing resolution and efficiency will likely require combining two or more of the methods described below.



Schematic depiction of double-patterning process. (W. Chao et al., *J. Vac. Sci. Technol. B* **27**, 2606, 2009)

### Resolution is limited by patterning technology.

To address resolution limits, ongoing developments in the semiconductor industry should be leveraged. In the past few years, such leveraging has become increasingly relevant, as the pace of feature shrinkage in semiconductor devices has well outpaced the progress in zone plates. The semiconductor industry is doing large-volume production at feature sizes on par with current zone-plate limits. Semiconductor manufacturing advancements that have recently been applied to zone-plate manufacturing, and that should continue to be explored, include double exposure and self-aligned double patterning.

In double exposure, two complementary exposure and pattern-transfer steps are performed, allowing looser-pitch larger-duty cycle patterning to be performed in each exposure step. The figure above depicts the concept in which each exposure is used to pattern every other zone. The primary challenge in this process is adequate alignment of the two exposures. The alignment accuracy should be a small fraction of the outer zone width.

In self-aligned double patterning, a single looser-pitch larger-duty cycle structure is patterned and a second material is conformally deposited. This can be achieved through a simple spin on process or deposition processes such as atomic layer deposition (ALD). The figure on the next page depicts this “sidewall” process, in which the problem of pattern alignment can be avoided. The downside, however, is the variable-duty cycle that arises across the optic, given that the deposited material has the same width throughout instead of the varying zone width required for an ideal zone plate. In practice, however, this may not be a limiting constraint.

The double-patterning methods discussed above gain their benefits from the fact that it is considerably easier

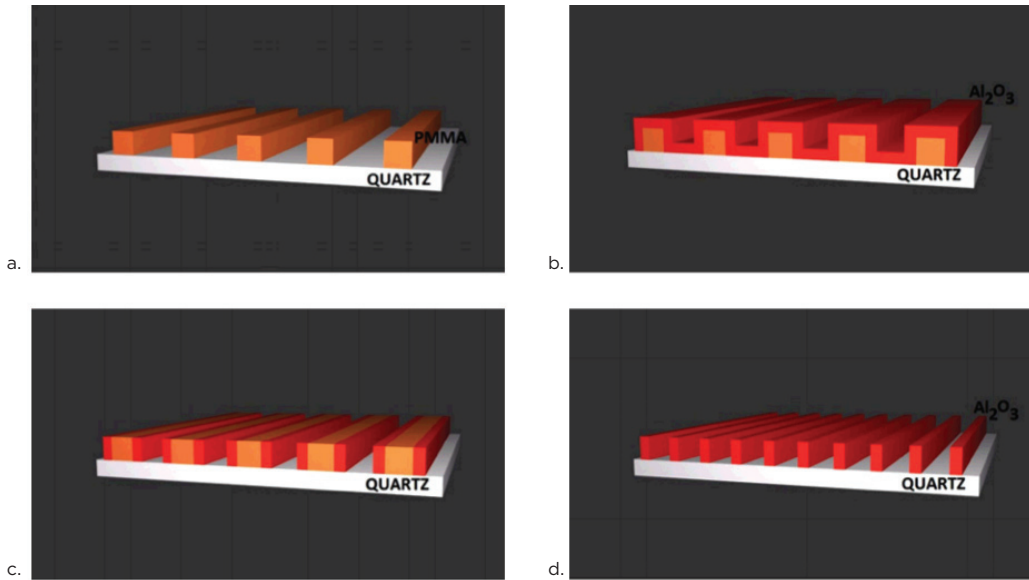

Schematic depiction of ALD process. (S. Dhuey et al., *Nanotechnology* 24 105303, 2013)

to pattern small structures on a loose pitch than it is to pattern those same small structures on a dense pitch. There exist, however, limits to how small even isolated features can be directly patterned. Such limitations could negatively impact the utility of double-patterning methods. To address this issue, the semiconductor industry now routinely uses “shrink” technology, in which the patterned structures are first shrunk through a sidewall etch process and then put through the double-patterning process.

#### The efficiency of zone plates is limited by materials and aspect ratio issues.

For the resolution case discussed above, research in improving zone-plate efficiency should leverage ongoing development in the semiconductor industry. For improvements in zone-plate aspect ratios, the same double-patterning method described above for pitch splitting could be applied to directly overlay patterns rather than interlace them. This way, the pattern can be built up in the vertical direction. To facilitate uniform stacking, the process could also be combined with a semiconductor chemical-mechanical planarization (CMP) process, ensuring a planarized base for the subsequent stack. These methods can be seen as integrated equivalents to the presently used physical stacking of discrete zone plates.

The semiconductor industry has also made great strides in deep silicon etching. These methods should also be explored for the fabrication of high-aspect-ratio zone plates. Examples of such etches include catalytic etching (a wet-etch process) and inductively coupled plasma (ICP) reactive ion etching (RIE). Both catalytic etching and ICP-RIE have successfully been used to fabricate very high-aspect-ratio silicon nanowires, as shown in the figures on the next page. Note that the difficulty grows exponentially as feature sizes shrink, even at fixed aspect ratios. This is a function of the interfeature size and capillary forces that distort the weaker high-aspect-ratio structures.

Another crucial area of research, especially in the softer X-ray regime, is in phase-shifting materials and the nanopatterning of those materials, including 3-D patterning. An ideal binary-phase zone plate can in principle have four times the efficiency of an ideal amplitude zone plate. Combining such materials with 3-D patterning would allow the fabrication of blazed structures, allowing even higher efficiencies to be obtained. This arguably represents the highest risk path, due to the complexity and divergence from semiconductor industry development goals.

In addition to leveraging advances from the semiconductor industry, research should be conducted in several areas where there is a divergence of requirements between semiconductor industry and X-ray optics needs. For example, the development of MLL lenses demonstrates an X-ray-specific concept with which very-high-aspect ratios, and thus diffraction efficiencies, can be achieved. Research into this and similar nonlithographic approaches may not only deliver substantial advances in effective efficiency themselves, but may also be able to significantly leverage existing lithographic advances in zone-plate manufacturing.

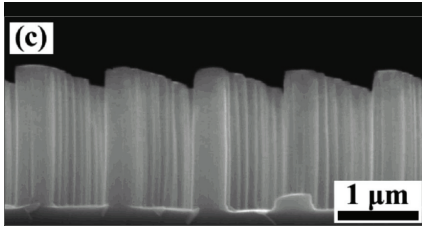

Silicon nanowire fabrication using catalytic etching. (W. K. Choi et al., *Nano Lett.* **8**, 3799–3802, 2008)

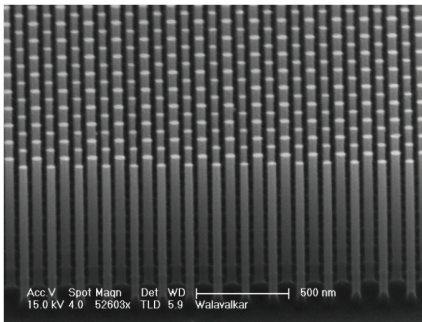

Silicon nanowire fabrication using ICP etching. (M. D. Henry, *ICP Etching of Silicon for Micro and Nanoscale Devices*, California Institute of Technology, Ph.D. Thesis, 2010)

For example, recent results point to the possibility of far-field stacking of geometrically scaled zone plates, without loss of spatial resolution or efficiency with adequately patterned “conventional” zone plates. It also has been proposed to extend near-field stacking methods to complementary stacking, where the stacked zone plates actually have interlaced zones. This is the mechanical-stacking equivalent to the double-patterning approach discussed in the *Resolution* section. Similarly, R&D into novel materials, which while perhaps not ideal for the ultimate spatial resolution or incompatible with standard processing in the semiconductor industry, could significantly increase achievable aspect ratios.

#### Limited size of zone plates leads to short focal length in objective zone plates.

A promising path to combining both increased zone-plate size and ultrahigh resolution is the exploitation of new resist-materials development. Again, developments in the semiconductor industry — including extreme ultraviolet (EUV) lithography, e-beam direct-write semiconductor wafer patterning, and semiconductor mask-manufacturing areas — should be leveraged. Examples of promising areas that should be explored for zone-plate applications include new ultralow-diffusion chemically amplified resists as well as inorganic resists. The bulk of the relevant resist development work performed by the semiconductor industry has been in EUV lithography, but given that EUV resists work through a secondary electron process rather than a primary photon process, the EUV work should be very applicable to the e-beam methods typically used for zone-plate fabrication.

Another compelling approach to the zone-plate size issue is to explore pattern-replication methods such as nanoimprint. In this way, one can spend much more time and endure relatively low yield in the production of a master that can then be replicated via a faster and higher-yield process using well-established commercial tools.

#### Radiation damage limits the lifetime of nanodiffractive optics.

Sufficient lifetime of diffractive optics is important if it is not to negatively impact practical use in real experiments. At a minimum, they should withstand an experimental period of several months. From an economic standpoint, it is clearly preferred to extend the life of these optics, especially when considering more-complex, higher-cost optics. Early testing in experimental conditions should be part of future diffractive-optics developments to eliminate materials systems and processes that cannot provide practical life spans. Applications for FELs will require additional research to produce optics that can withstand the high peak power of these sources.

## Impact

Zone-plate-based microscopes play a critical role at every DOE light source, and are typically oversubscribed by a factor of 3 or more. The Advanced Light Source (ALS) has three scanning and three full-field microscopes; the Advanced Photon Source (APS) has two zone plate-based nanoprobe (including the hard X-ray nanoprobe jointly operated with the Center for Nanoscale Materials), three zone-plate-based microprobes, two full-field microscopes, and plans for a new in situ nanoprobe as part of the APS upgrade. The Stanford Synchrotron Radiation Laboratory (SSRL) operates a full-field transmission X-ray microscope; at Brookhaven National Laboratory (BNL), a nanoprobe, a microprobe, and a TXM are in construction, and several additional zone-plate-based instruments are in the planning stages.

Zone-plate-based X-ray microscopes have and continue to generate significant impact in many scientific areas, including nanomagnetism, energy and material science, environmental science, polymer science, geoscience, and life science. The newest generation of instruments incorporates state-of-the-art mechanical and detector systems, including sophisticated laser encoding for scanning systems. Modern detector systems have allowed a significant speedup of data acquisition. The resolution and efficiency of focusing optics have become the dominant limiting factor in zone-plate microscopy. This will become even more apparent as the next generation of high-brightness sources come online.

Although the technique has been central to many scientific breakthroughs over the past two decades, its present limits on resolution and efficiency keep many scientific challenges just out of reach. In practice, current microscopes are limited to practical resolutions of 15-20 nm in the soft X-ray range and 50-70 nm in the hard X-ray range. Pushing resolutions to the 5-10 nm range and below will have dramatic new impacts on science and technology.

Moreover, X-ray microscopy provides a pathway to unprecedented views into mesoscale systems. Crucial to scientific progress in this domain is sub-10-nm lateral resolution combined with a field of view in the range of many microns, along with imaging in the third dimension by way of either tomography or confocal microscopy. Below we touch on a few examples of critical scientific areas where progress is currently hampered by zone-plate limitations.

- Solar energy conversion.** X-ray fluorescence microscopy has played a crucial role in understanding solar-cell performance limitations by mapping metal impurities in multicrystalline solar cells. Despite excellent results to date, current zone-plate resolution limitations constrain the size of detectable impurities, and efficiency limits constrain the measurable field of view. These deficiencies are becoming more important as the field moves away from single-element materials to much more complex materials such as Cd-In (Ga)-Se(S) and structures with built-in plasmonic components to enhance light harvesting. Improvements in both zone-plate resolution and efficiency are crucial to complete understanding of photo-cell efficiency limits and ultimate improvements in performance.
- Energy storage and catalysis.** In the area of energy science, coupling high-resolution, full-field, and even confocal microscopy with high-resolution spectroscopy will enable the study of oxidation states in 3-D within energy-storage devices with nanoscale resolution. For example, such methods have already been used to look at the chemical state of individual nanoparticles. Further progress, however, requires development of zone plates that will allow resolution well below 10 nm, so that the ultrasmall size range most relevant to catalytic activity can be probed.

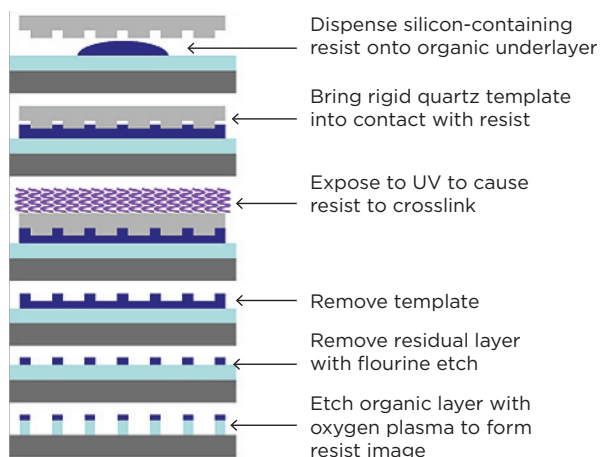

Process flow for the nanoimprint method. ([http://www.almaden.ibm.com/st/past\\_projects/nanoimprint/](http://www.almaden.ibm.com/st/past_projects/nanoimprint/))

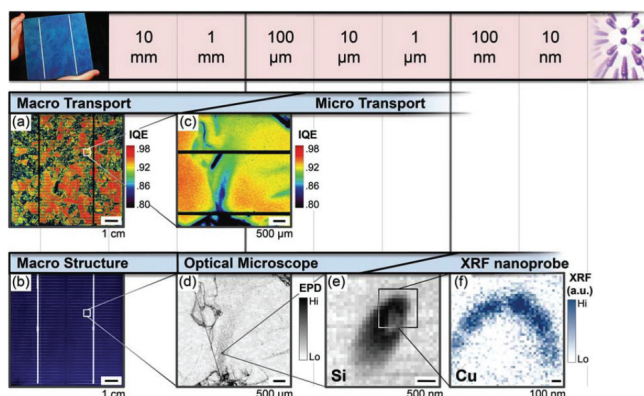

Hierarchical characterization of multicrystalline solar-cell material from the centimeter to the nanometer length scale. (a) Full-wafer internal quantum efficiency (IQE) map, illustrating high- and low-performance areas. (b) Full-wafer reflected light image. (c) A region of interest of the IQE map. (d) Optical microscope image of etched sample indicates dislocations present at intragranular regions. (e) Nano-XRF is used to map the dislocation etch pits. The silicon channel is surface-sensitive, thus yielding topographical information. (f) A region of the etch pit is selected for high-resolution nano-XRF, indicating that copper is present at the dislocation. (Bertoni, M.I., et al., *Energy & Environmental Science* 4, 4252-4257, 2011)



## Full-field and Scanning X-ray Microscopy

X-ray microscopy using zone plates can be done in two complementary ways. In transmission X-ray microscopy (TXM), a large condenser zone plate focuses light onto a field of view at the sample. Light that passes through the sample is magnified by an objective zone plate onto a charge-coupled device (CCD). Data collection is therefore in parallel. In scanning transmission X-ray microscopy (STXM), monochromatized X-rays are focused onto the sample in a small spot. An image is built up by recording the response of the sample (transmission, fluorescence, electron yield) pixel by pixel, as the sample is scanned in the fixed focus. See also: Kirz, J., C. Jacobsen and M. Howells (1995) *Soft x-ray microscopes and their biological applications*. Quarterly Reviews of Biophysics. 28(1): p. 33-130.

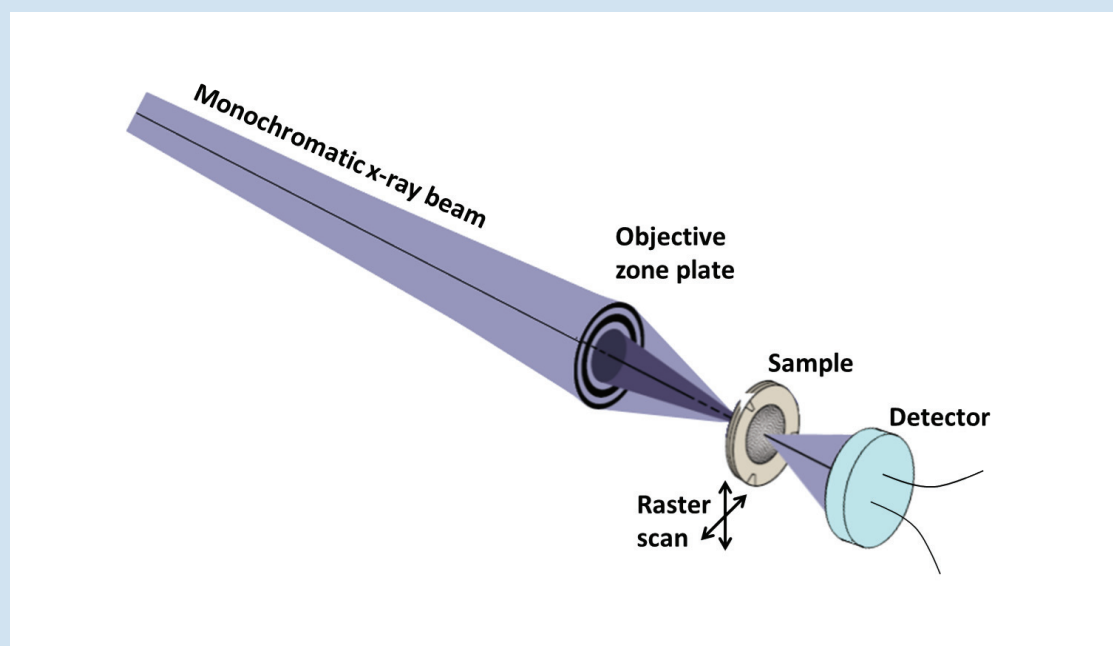
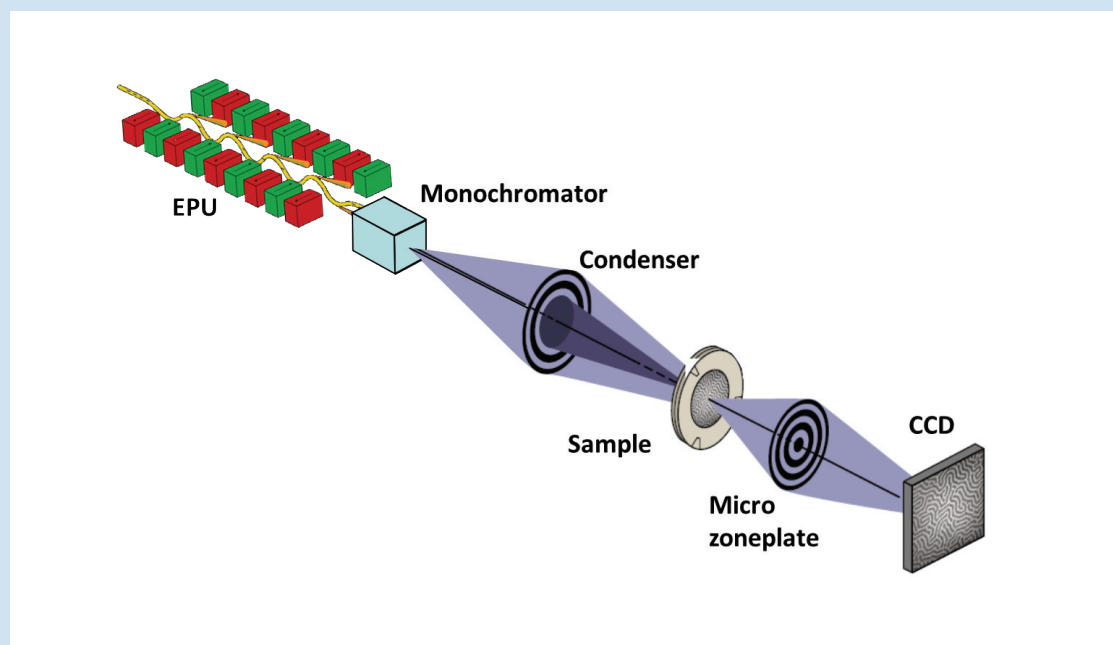

- **Mesoporous materials.** Mesoporous materials are extremely promising for carbon sequestration, hydrogen storage, dye-sensitized solar cells, photoelectrochemical cells, electrochromic devices, or catalytic systems such as lithium batteries and solid-oxide fuel cells. The key to understanding the performance of such systems is spectrally resolved 3-D imaging at a few nm resolution. This would enable the visualization of the connectivity and the oxidation states in these materials at the scale of single building blocks, which, in the example below, is a 5-nm TiO<sub>2</sub> nanoparticle, while embedded in larger supporting structures.

- **Spintronics.** Spintronics, i.e., electronics that harnesses the unique properties of the electron spin, provides a potential pathway to fundamentally transforming the energy-demand landscape. At current rates, information technology-related energy consumption will very soon dominate U.S. energy demand. By controlling electron spin instead of electron charge, power consumption can be dramatically reduced. Standby power consumption in electronic circuits now accounts for the majority of the total power budget and continues to increase. Spintronics can, in principle, drive standby power requirements down to zero. Additionally, because signal transfer in spin-only-driven electronic circuits does not actually require a charge-current flow, active power consumption can also be substantially reduced. Crucial to bringing this technology to fruition is the ability to directly image-spin structures and their dynamics “in operando” at the nanoscale.

Taking advantage of X-ray magnetic circular dichroism (XMCD) effects, soft X-ray microscopy serves as the ideal vehicle to the study of spin and spin dynamics at the nanoscale. To date, 20-nm zone-plate resolution limits have restricted us to studying vortex cores in film thicknesses of 50 nm and more. Technologically relevant studies essential to addressing our energy needs requires us to study sub-10-nm thickness films with a lateral resolution in the 5 nm range with high efficiency.

- **Shale rock.** Digital rock physics (DRP) is an established commercialized technique that is replacing traditional rock core analysis to determine flow parameters. DRP uses X-ray tomography to determine the 3-D structure of rock and then employs a computer model to extract the flow parameters relevant to oil and gas extraction. It is a highly successful technology experiencing rapid adoption for conventional oil and gas rock formations. The United States has extensive oil-shale deposits that could provide increasingly greater energy independence if the oil can be extracted in a safe, efficient, and cost-effective manner. DRP using X-ray tomography cannot currently be applied to shale rock due to its very small pore size, typically down to less than 10 nm. Significant thicknesses need to be probed to get a good statistical view of the material, and so this high resolution is needed at high energy, requiring advances in high-aspect-ratio zone-plate technology.

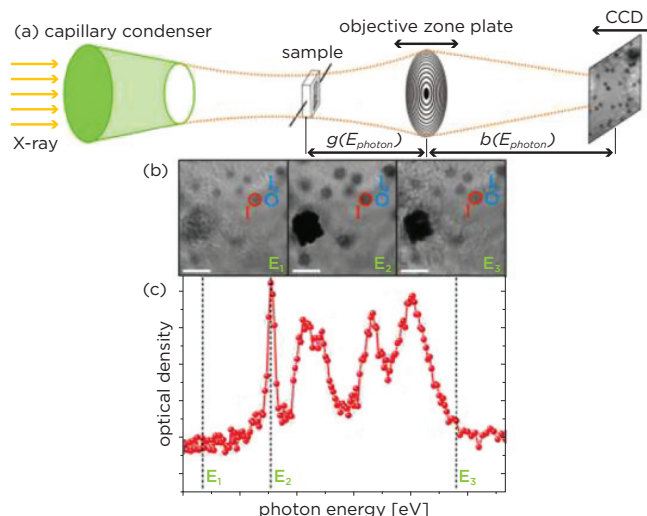

Spectroscopic imaging of nano particles. (K. Henzler, *Nano Lett.* 13, 824–828, 2013)

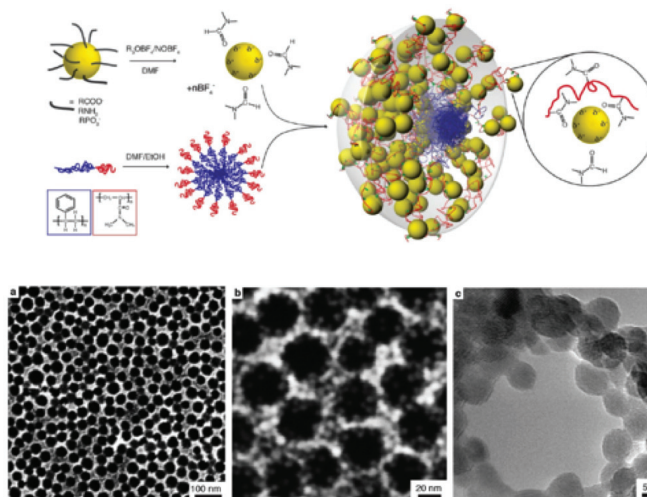

Example of mesoporous material. (R. Buonsanti, et al., *Nano Lett.* 12, 3872–3877, 2012)

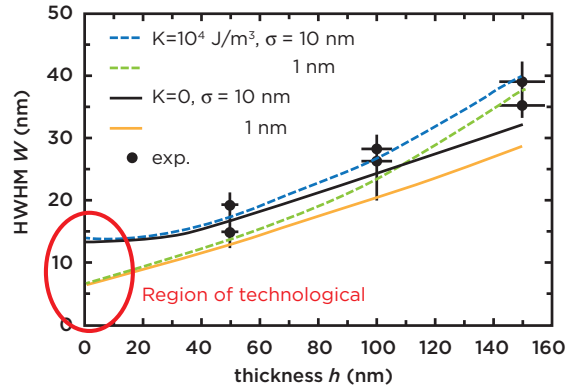
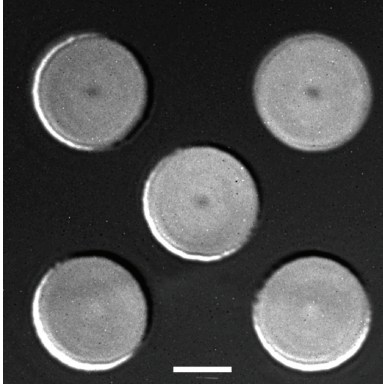

Soft X-ray image of 20-nm vortex cores in 50-nm-thick films and a plot of the predicted vortex core diameter as a function of film thickness. (P. Fischer, et al., PRB 83, 212402, 2011)

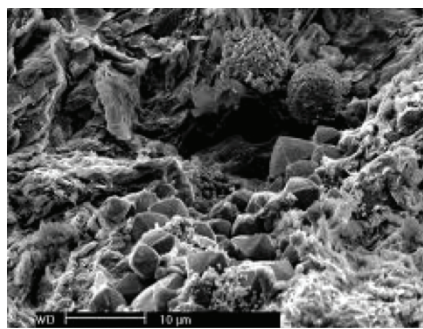
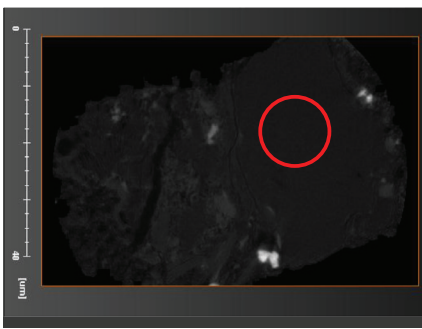

Shale rock is highly heterogeneous and hierarchical in its composition. The figure to the left shows a rendering of X-ray tomography of a shale sample that illustrates the heterogeneous, hierarchical structure of shale rock. For DRP, a complete understanding of the different phases in the rock, including the phase that appears almost uniform in density (red circle), is required for accurate modeling.

The figure to the right shows a fractured shale sample imaged in a scanning electron microscope, which shows the heterogeneity of the sample and the very small size of the pores that are critical for modeling fluid transport.

## References

1. J.L. Soret, *Sur les phénomènes de diffraction produits par les réseaux circulaires*, Arch. Sci. Phys. Nat. 52, 320-337, 1875.
2. A. Baez, *A Self-supporting metal Fresnel zone-plate to focus extreme ultra-violet and soft X-rays*, Nature 186, 958, 1960.
3. A. Baez, *Fresnel zone plate for optical image formation using extreme ultraviolet and soft X radiation*, Opt. Soc. Am. 51, 405-412, 1961.
4. D. Sayre, *Proposal for the utilization of electron beam technology in the fabrication of an image forming device for the soft X-ray region*, Technical Report RC 3974 (#17965), IBM T. J. Watson Research Laboratory, Yorktown Heights, New York, 1972.
5. G. Schmahl and D. Rudolph, *Lichtstarke Zonenplatten als abbildende Systeme fuer weiche Roentgenstrahlung (High power zone plates as image forming systems for soft x-rays*, Optik 29, 577-585, 1969.
6. J. Kirz, *Phase zone plates for x rays and the extreme UV*, J. Opt. Soc. Am. 64, 301-309, 1974.
7. A.G. Michette, "Optical Systems for Soft X Rays," Plenum, New York, 1986.
8. E. Di Fabrizio et al., *High-efficiency multilevel zone plates for keV X-rays*, Nature 401, 895-898, 1999.
9. W. Chao et al., *Soft X-ray microscopy at a spatial resolution better than 15 nm*, Nature 435, 1210-1213, 2005.
10. J. Kirz, C. Jacobsen, and M. Howells, *Soft x-ray microscopes and their biological application*, Quarterly Reviews of Biophysics 28, 33-130, 1995.
11. P. Fischer et al., *Soft X-ray microscopy of nanomagnetism*, Materials Today 9, 26-33, 2006.
12. H. Ade and H. Stoll, *Near-edge X-ray absorption fine-structure microscopy of organic and magnetic materials*, Nature Materials 8, 281-290, 2009.
13. S. Hudelson et al., *Retrograde melting and internal liquid gettering in silicon*, Advanced Materials 22, 3948, 2010.
14. U.E.A. Fittschen and G. Falkenberg, *Trends in environmental science using microscopic X-ray fluorescence*, Spectrochimica Acta Part B-Atomic Spectroscopy 66, 567580, 2011.
15. T. Paunesku et al., *X-ray fluorescence microprobe imaging in biology and medicine*, J Cell Biochem 99, 1489-1502, 2006.
16. H.C. Kang et al., *Focusing of hard x-rays to 16 nanometers with a multilayer Laue lens*, Applied Physics Letters 92, 221114, 2008.

# Crystal Optics

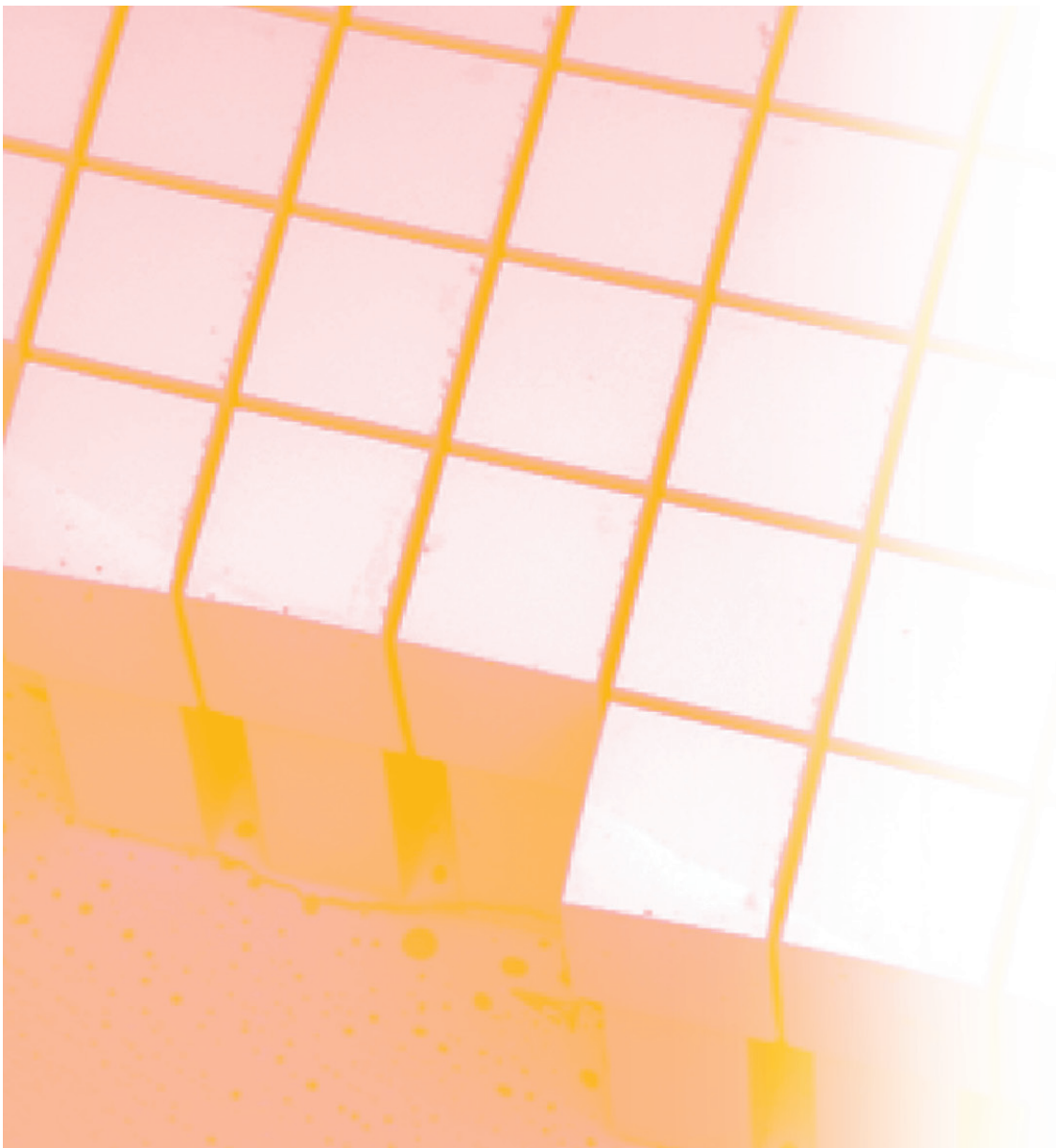

## Summary

Crystal optics has numerous examples, including spectral filters, polarization filters, phase plates, beam splitters, interferometers, etc. Spectral filters (monochromators and analyzers) make up the largest class of these and the state of the art was briefly reviewed with an eye toward issues that currently inhibit scientific progress and those that might arise with future sources. These issues, if resolved, could significantly extend X-ray measurement capabilities.

- Resonant inelastic X-ray scattering (RIXS) has potential for expanding our understanding of electronic behavior in a variety of technologically relevant materials, but its application is often hindered by inadequate energy resolution and/or the lack of suitable energy analyzers. The use of only silicon (or in some cases, germanium) limits the possible X-ray energies at which medium-energy-resolution (20-200 meV for X-ray energies of 6-16 keV) analyzers can be made. In order to use RIXS to probe the electronic structure of complex materials containing a variety of atomic species, analyzers for different X-ray energies corresponding to relevant atomic resonances are required. To achieve this, materials other than silicon or germanium (viz., sapphire, quartz, and lithium niobate) must be developed in large, high-quality, single-crystal form.

### Working Group Chairs:

T.S. Toellner (ANL)

P. Siddons (BNL)

### List of contributors in alphabetical order:

A.Q.R. Baron (SPRING-8)

J. Härtwig (ESRF)

D. Mills (ANL)

H. Schülte-Schrepping (PETRA-III)

H. Sinn (EXFEL)

J. Sutter (DLS)

- For higher-resolution energy analyzers (a few meV or less), dicing of the analyzer is required to form an unstrained crystal in a spherical shape. The fabrication of such analyzers is currently more art than science; with the trend toward increasing the number of analyzers on a given instrument, better fabrication processes must be explored and developed.
- Increasingly brighter sources have associated new challenges, including (1) mitigating effects of higher average and peak powers (from X-ray free electron lasers [XFELs]), and (2) preserving a high degree of coherence. These difficult issues must be addressed to ensure optimal utilization of these high-brightness X-ray sources. Diamond crystals might be very useful for these high-power applications and therefore sources for perfect single-crystal diamonds with various orientations and sizes need to be fostered.

To resolve these issues, a number of R&D directions were presented. Addressing these areas would help exploit the full potential of future sources and significantly extend X-ray measurement capabilities.

## RECOMMENDATIONS

1. **Develop alternative crystalline materials (other than silicon) for X-ray optics.** This should include discussions with academic and industrial crystal growers to identify potential materials that might be candidates for the growth of large, high-quality single crystals and then collaborating with those growers to assist in the X-ray characterization of the crystals.

2. **Improve the fabrication process of X-ray energy analyzers.** Processing improvements should include bending accuracy, optic long-term stability, and increasing production capacity while maintaining adequate quality.
3. **Explore the limit of high-average and peak X-ray incident power on crystal optics and the crystal-optics requirements for preservation of X-ray beam coherence.** The effect on the performance of single-crystal optical components in terms of both the long-term (days) and short-term (femtoseconds) structural stability of the crystalline lattice under these power loadings must be further studied. In addition, the effects of fabrication processes, thermomechanically induced strain, and crystal inhomogeneities on coherence preservation should be further explored

## Scope

Crystal optics is a subclass of X-ray optics that involves the use of diffraction from 3-D periodic arrangement of atoms in a crystalline material. Crystal quality, in terms of the perfection of the placement of atoms at their ideal lattice sites, can limit the performance of optical components. In this chapter, we focus on X-ray optical components fabricated from high-quality or “perfect” single crystals, i.e., single crystals essentially free of lattice defects and strains. Optical elements fabricated from perfect crystals preserve the X-ray beam’s brightness. In addition, the diffraction properties of perfect single crystals are readily calculable, making performance of these optical components well understood and predictable.

Crystals strongly diffract electromagnetic radiation with wavelengths of the order of  $10^{-10}$  m because such wavelengths correspond to interatomic distances (see *Diffraction from Perfect Crystals*, next page) and satisfy the well-known Bragg’s law,

$$\lambda = 2 d \sin \theta \quad (1)$$

where  $\lambda$  is the X-ray wavelength,  $d$  is the spacing of the atomic planes in the crystal, and  $\theta$  is the angle between the incident X-ray beam and the planes.

By differentiating Bragg’s law, one gets the bandpass of the diffracted radiation:

$$\Delta E/E = \Delta \lambda/\lambda = \cot \theta (\Delta \theta) \quad (2)$$

where  $E$  is the energy of the monochromatic beam. The equation above assumes there are no variations in the atomic plane spacing, i.e.,  $\Delta d = 0$ . Gradients in the  $d$ -spacing can also contribute to a finite energy range but the use of high-quality, perfect single crystals mitigates the variation of  $d$ -spacing, assuming the crystal is not strained in the fabrication and/or mounting process. Silicon is most often used for crystal optics, as large, perfect single crystals are readily and cheaply available thanks to investments by the semiconductor industry. As we will see, one issue of single-crystal optics is the lack of availability of large single crystals of materials other than silicon.

Crystal optical components relevant to X-ray sources include spectral filters (monochromators and analyzers), beam splitters, polarization filters, phase retarders, interferometers, etc. The scope will be restricted here to monochromators and analyzers alone for two reasons:

- They dominate the demand with a large fraction of medium to hard X-ray beamlines relying on single-crystal monochromators for their performance.
- The issues that arise with them encompass most, if not all, other crystal optics.

The most common spectral filter is the monochromator. The purpose of the monochromator is to efficiently transmit a modest spectral width ( $\Delta E/E \approx 10^{-4}$  is typical for a silicon (111) monochromator). Since most synchrotron-radiation-based techniques can use this level of spectral filtering, crystal-based monochromators are very common at beamlines that use X-ray energies above a few keV. Monochromators are often the first optical element in the beamline, and such monochromators are called high-heat-load monochromators (HHLMs) as they must be

## Diffraction from Perfect Crystals

X-rays incident on a crystal will experience strong diffraction from planes of atoms when the X-ray wavelength satisfies a condition known as Bragg's law, which states that the path difference the X-rays experience while scattering from two adjacent parallel planes of atoms with a separation of  $d$  is an integer number of wavelengths,

$$\lambda = 2 d \sin \Theta$$

where  $\Theta$  is the angle the incident X-rays make with respect to the set of parallel atomic planes (see figure below). By differentiating Bragg's law, one gets the bandpass of the diffracted radiation:

$$\Delta E/E = \Delta \lambda/\lambda = \cot \Theta (\Delta \Theta)$$

Perfect crystals have a finite angular range of high reflectivity at the Bragg condition. The width of this high reflectivity,  $\omega_D$ , is called the Darwin width, after Charles Galton Darwin who first calculated this in 1914. The finite width of the Bragg reflection is a consequence of the fact that only a limited number of atomic planes participates in the diffraction process due to the finite penetration depth of the X-ray arising from photoelectric absorption and the diffraction process itself. The deeper the penetration of the X-rays in to the crystal, the more atomic plans participate in the diffraction process and the narrower the angular range of high reflectivity. (This is similar to the phenomenon observed at visible wavelengths when a beam of light is incident onto an array of slits: The width of the peak of the diffraction pattern is narrower the more slits are in the light beam.)

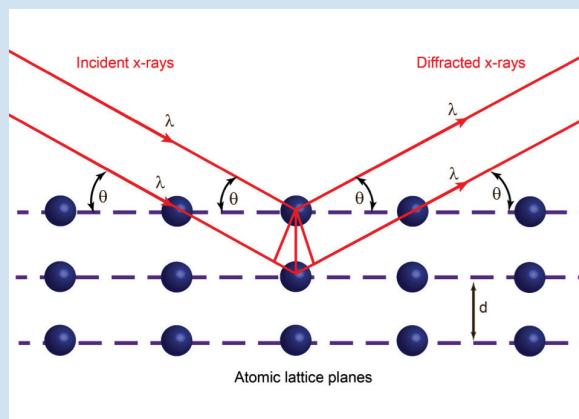

This angular region for which there is high reflectivity is called the Darwin width (below). The dashed line shows the reflectivity for Si (111) at 8 keV with no absorption, while the solid line shows the calculated reflectivity when absorption is included. For perfect single crystals,  $\Delta \Theta$  in the equation at left has two components that must be added in quadrature to determine the bandpass: the angular range of reflection intrinsic to the crystal itself (Darwin width); and the range of angles,  $\Delta \varphi$ , of the incident X-ray beam. By restricting the range of angles that X-rays make with respect to the atomic planes, one restricts the range of wavelengths that are diffracted to that intrinsic to the crystal. For high-brightness X-ray beams, such as those generated by an undulator at a third-generation source, the divergence of the X-ray beam  $\Delta \varphi$  is often smaller than the Darwin width, and therefore the energy bandpass is determined by the intrinsic angular reflectivity range of the crystal. This is the basis for making a spectral filter using a crystal. For the purposes of X-ray optics, diffracting crystals can be thought to act like filters that transmit some X-rays and not others, based on whether they have specific characteristics. This property allows them to be used to alter the characteristics of an X-ray beam or to select the desired X-rays from the undesired. The reflectivity of perfect crystals over the Darwin width can be very close to unity, allowing the X-ray beam to be diffracted many times by perfect single crystals with minimal loss of intensity.

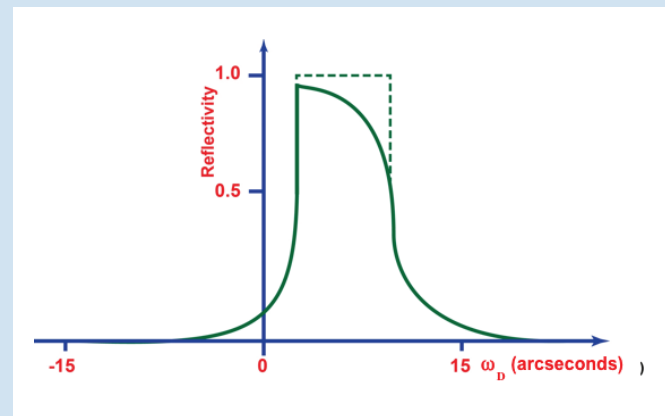



## Resonant Inelastic X-ray Scattering (RIXS)

The emergence of IXS has been one of the most significant developments in X-ray instrumentation at hard X-ray synchrotron radiation facilities in the past decade. IXS has been successfully employed to study electronic and vibrational excitations in real materials of fundamental and technological importance, spanning a broad spectrum of scientific disciplines that reaches from fundamental physics to materials science, biophysics, and geophysics. RIXS, one variety of IXS with a medium-energy resolution of currently 80 meV to 300 meV, is particularly well suited to study elementary electronic excitations in complex materials by measuring their dependence on energy, momentum, and polarization. It is also a bulk-sensitive technique, can probe excitations across the full Brillouin zone, and is element and orbital specific, allowing only those excitations that are directly relevant to be studied. A vast body of important information has been accumulated by this unique technique in the past decade, especially with regard to correlated electron systems in transition metal compounds (see for example reference [5]). These materials are the hosts of such technologically important phenomena as high- $T_c$  superconductivity and colossal magnetoresistance.

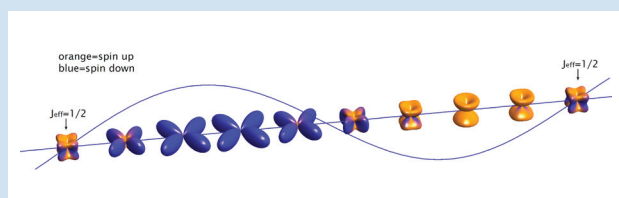
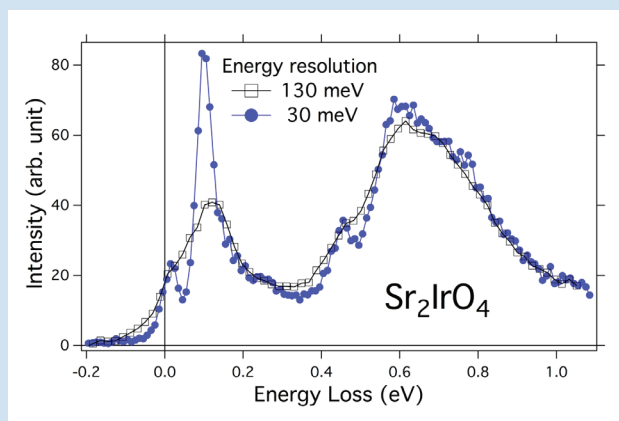

designed to operate under the high thermal loading of the X-rays from insertion devices. The primary challenge in designing HHLMs is to effectively deal with the unfiltered white beam, which from present-day storage-ring-based synchrotron facilities can have power densities of many hundreds of watts/mm<sup>2</sup> and total power of up to a kilowatt, while minimizing thermally induced strains that can produce gradients in the d-spacing. Careful attention must be paid to thermal and vibrational management in the design of these HHLMs, and because they are such ubiquitous components, there is an ongoing engineering effort to improve them.

Selection of both the central wavelength,  $E$ , and the range of wavelengths (or bandpass),  $\Delta E$ , around the central wavelength often determines how the X-ray will interact with a sample under study. This allows more precise targeting of a particular phenomenon for investigation. For example, spectroscopies such as RIXS that target atomic resonances to study the electronic structure of materials require both a very specific central wavelength and small bandpass (see *Resonant Inelastic X-ray Scattering (RIXS)* at left.). For such techniques, additional spectral filtering for higher energy resolution ( $\Delta E/E \sim 10^{-5} - 10^{-6}$ ) is required for both the X-rays impinging on the sample as well as for those that scatter from it. To achieve energy resolution at this level requires special geometries for the optical components, often Bragg scattering with the angle of incidence near 90°. Other spectroscopies such as high-resolution inelastic X-ray scattering (IXS) need even higher levels of spectral filtering ( $\Delta E/E \sim 10^{-7}$ ) to target the dynamics of cooperative atomic motions in materials.

Not only are high-resolution monochromators required, but there is a need for high-resolution analyzers that separate the inelastically scattered X-rays of the desired energy from both the elastically scattered photons and the unwanted inelastically scattered X-rays. Since the inelastically scattered signal is weak and diffuse, these analyzers must cover a large solid angle to provide useful intensity and build up the necessary statistics. To do this efficiently, it is desirable to form the analyzing crystals into a spherical shape and place them in a Rowland circle geometry so that the X-rays of the desired energy are all diffracted by the analyzer and then focused on a small detector (see *Schematic of Experimental Set-up for Resonant Inelastic X-ray Scattering (RIXS)* on the next page). Bending a crystal while minimizing lattice strains is presently more art than science. The development of high-energy resolution monochromators and analyzers is key to the successful development of both resonant and nonresonant IXS techniques, as well as nuclear resonant scattering programs.

## Issues

### HIGH-HEAT-LOAD MONOCHROMATORS

Advances in accelerator physics and insertion-device technology have resulted in increasingly powerful X-ray beams at third-generation X-ray sources. The current standard for an HHLM uses crystalline silicon cooled with liquid nitrogen ( $\text{LN}_2$ ). Silicon exhibits an increased thermal conductivity ( $k$ ) at cryogenic temperatures, which improves heat transfer. At the same time, silicon's coefficient of thermal expansion ( $\alpha$ ) decreases (and actually becomes negative around 123 K), which results in smaller lattice distortion for a given thermal gradient. This helps to mitigate thermally induced d-spacing variation of the crystal lattice over the diffraction region, allowing it to perform well as a spectral filter. Attaching  $\text{LN}_2$  cooling manifolds to the crystals while minimizing mechanical strains in the crystal monochromator can pose a real challenge. Operating high-power X-ray optics cooled by pressurized liquid nitrogen is a technical challenge, but is more or less a standard approach at many synchrotrons today.  $\text{LN}_2$ -cooled-silicon HHLMs have proven to work reasonably well for power loads below 1 kW and power densities of a few hundred  $\text{W}/\text{mm}^2$  but there can be unwanted effects on the diffracted beam (beam motion) associated with vibrations induced by the  $\text{LN}_2$  flowing through the monochromator and/or its manifolds. This issue has been resolved at current power loads, but may resurface for future power loads that require significantly higher  $\text{LN}_2$  flow rates.

An alternative to  $\text{LN}_2$ -cooled silicon is diamond, which has superb thermal conductivity and a low coefficient of thermal expansion, and has nearly the same thermomechanical figure of merit ( $k/\alpha$ ) at room temperature as silicon at liquid nitrogen temperature. Diamond has the additional advantage of a lower X-ray absorption than silicon and hence less heat deposited in the optic. Although synthetic single-crystal diamond is available, it is limited in size (typically less than 5-8 mm x 5-8 mm) and often lacks the uniformity of crystalline silicon. Higher-quality, large (>1 cm x 1 cm) single-crystal diamond is required for routine application of diamond as an HHLM. Improving the uniformity and available size of crystalline diamond will be critical to fully exploiting the potential of future high-powered X-ray sources.

Increasingly brighter sources bring completely new challenges for X-ray optics designers. For example, high-quality diamonds would seem to be ideal candidates for mirrors in X-ray free electron oscillators where thermal distortions must be kept to a minimum. In other applications, monochromators are designed to allow the hard X-rays to pass through the mono-

### Schematic of Experimental Set-up for Resonant Inelastic X-ray Scattering (RIXS)

A typical experimental arrangement for RIXS is shown. The X-rays from an undulator are monochromated by the high-heat-load monochromator ( $\Delta E/E \approx 10^{-4}$ ) and the bandpass is further reduced ( $\Delta E/E \approx 10^{-5}$  to  $10^{-6}$ ) by high-resolution monochromators. After being inelastically scattered by the sample, the X-rays of the desired energy are sorted out and focused onto a detector by a spherically bent analyzer. The monochromators, high-resolution monochromators, and analyzer are all fabricated from perfect single crystals of silicon.

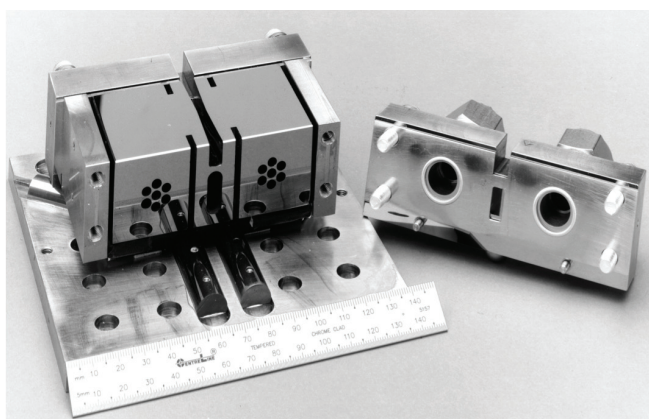
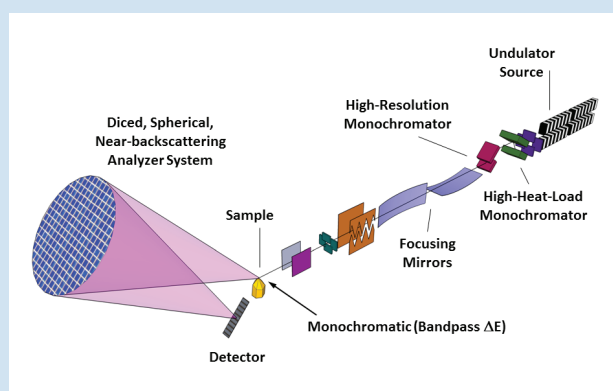

**Above:** A liquid nitrogen ( $\text{LN}_2$ )-cooled-silicon monochromator with its manifold. In this implementation, the  $\text{LN}_2$  flows through the hexagonal array of cooling channels in the silicon. Metal C-rings seal the manifold to the crystal. The vertical cuts in the silicon are to relieve strain in the crystal from force needed to compress the C-rings. X-rays are diffracted from the thin web in the middle of the crystal.

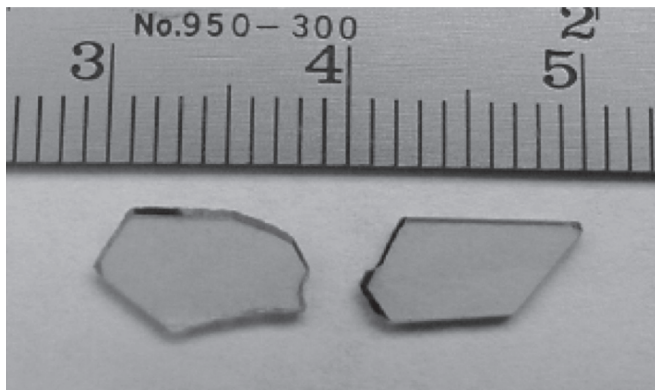

Single-crystal diamond with the perfection required for use as X-ray optics cannot be found in nature, and synthetic diamonds are the only alternative. Currently, perfect single crystals of synthetic diamond can only be grown less than 1 cm in size, limiting their usefulness in many applications. (M. Hu)

chromating crystal so that the transmitted X-rays can be used in a separate instrument (beam splitters), allowing two simultaneous experiments to be performed on one insertion device. Here again, diamonds would be an ideal first monochromating element as they transmit the higher-energy X-rays with less absorption than does silicon. Highly transmitting monochromators can also be used for the self-seeding of XFELs. The Linac Coherent Light Source (LCLS) uses a perfect crystal diamond to seed the X-ray beam to produce a higher-quality X-ray beam than can be achieved with the self-amplified stimulated emission (SASE) process. However, very high-powered, short-pulse-length X-ray FEL sources may affect the diffraction behavior in unwanted ways and/or adversely affect the stability of the crystal lattice, a research area that is essentially new to the field of X-ray crystal optics. All these issues must be addressed while maintaining the coherence properties of the beam to ensure optimal utilization of these high-brightness X-ray sources.

#### HIGH-ENERGY-RESOLUTION MONOCHROMATORS FOR INELASTIC X-RAY SCATTERING

The emergence of IXS has been one of the most significant developments at hard X-ray synchrotron radiation facilities in the past decade. Inelastic scattering can provide information on the dynamics of the sample from phonons (nonresonant inelastic scattering with meV energies) to the electronic excitations (resonant inelastic scattering with sub-100 meV energies). IXS has been used with diamond anvil cells to measure the sound velocity of materials that might be found in the Earth's core under the relevant pressures and temperatures to get a better understanding of seismic-wave propagation through the inner core. RIXS has shed new light on 5d-transition-metal oxides, such as the iridates, which have complex interactions involving spin, charge, orbital, and lattice degrees of freedom, with the addition of strong spin-orbit-coupling due to the large Z (hundreds of meV, c.f. tens of meV in the 3d transition metals). These measurements typically involve very low counting rates (as compared with elastic scattering) and in the future will require both higher efficiency and higher-energy-resolution monochromators and analyzers to advance the field.

Examination of Equation (2) (in this chapter's *Scope* section) will lead immediately to the conclusion that one way to improve energy resolution (i.e., reduce  $\Delta E/E$ ) is to drive the cotangent function to smaller values by making  $\theta$  approach  $90^\circ$ . This tactic is used in the design of both high-energy-resolution monochromators and analyzer systems, where near-back-reflection is used at higher X-ray energies ( $>20$  keV) to achieve resolutions of less than one meV. At this level of energy resolution, silicon is presently the only crystalline material with acceptable quality.

A state-of-the-art high-resolution monochromator uses silicon crystals and is gas-cooled to 123 K to minimize the d-spacing variation within the crystal lattice caused by small temperature gradients. The entire monochromator, including mechanics and sensors, must be held at that cryogenic temperature with sufficient attention paid to vibration mitigation. An energy bandwidth of 0.2 meV at 21.5 keV has been demonstrated with this approach that uses active feedback control to maintain crystal angles within 3 nrad (rms) of target values [1]. While this represents the third-best energy resolution ever achieved with crystal optics, the other two instruments (0.12 meV at 14.4 keV [2] and 0.14 meV at 23.9 keV [3]) had efficiencies 10-1,000 times lower and wavelength instabilities that made them unusable for nuclear resonant spectroscopy (NRS). The cryogenically stabilized, high-resolution monochromator demonstrates an energy stability of 0.015 meV (rms) or less than 1 part per billion, which would make it acceptable as a spectroscopic instrument given an X-ray source that delivers sufficient spectral flux.

#### HIGH-ENERGY-RESOLUTION ANALYZERS FOR INELASTIC X-RAY SCATTERING

When the purpose of a spectral filter is to analyze the wavelength of the radiation scattered from a sample, it is typically designed to accept rays over a much larger solid angle and is referred to as an energy analyzer. These are employed for spectroscopic applications such as X-ray emission spectroscopy (XES), X-ray Raman spectroscopy (XRS), as well as RIXS and IXS. Analyzers for X-rays usually involve using a crystal reflection with

a d-spacing that has a large Bragg angle (near  $90^\circ$ ) at the X-ray wavelength of interest. This results in a small energy acceptance as desired, but is only possible over a very limited energy range near the back-reflection ( $2\theta=180^\circ$ ) geometry. Furthermore, a given crystalline material offers only a small, discrete set of d-spacings from which to choose, leading to a discrete set of energy ranges possible with a given crystalline material. This limits the usefulness of the technique to samples whose absorption-edge energies conveniently fall near the backscattering energy for a set of atomic planes in silicon. To attain an acceptable energy resolution at a given energy, it is sometimes necessary to use a different crystalline material that also has a small, discrete set of energy ranges, but that may provide a better match for a particular energy. For this purpose, a number of crystalline materials other than silicon have been considered for low- to medium-energy resolution analyzers — including germanium, sapphire, quartz, and lithium niobate — but these are not widely in use due to lack of high-quality crystals in sufficient size. (Note that diamond does not appear on this list owing to its current availability in very small sizes only.) Improved crystal quality over sufficiently large regions of an X-ray optic material will significantly improve the performance of X-ray optical components. To mitigate this problem, development of alternative crystalline materials (other than silicon) for X-ray optics is critically important.

To accept a large solid angle, the analyzer typically is bent spherically to improve efficiency. This works well for low-energy-resolution analyzers as long as the lattice strain from bending does not significantly affect the energy resolution. For higher-resolution energy analyzers, bending is not acceptable, so dicing and forming unstrained crystal pixels to a polygonal approximation to a concave spherical shape is the standard practice (see *Spherical Analyzers for High-Energy-Resolution Inelastic X-ray Spectroscopy* below). There has been significant development in fabrication of spherically shaped analyzers over the years, but it remains something of an “art” to construct these analyzers without some deterioration of the crystal perfection from the X-ray diffraction point of view. The issues related to fabrication of high-resolution analyzers — i.e., cutting, etching,

### Spherical Analyzers for High-Energy-Resolution Inelastic X-ray Spectroscopy

Spherical X-ray analyzers and high-resolution monochromators are the backbone of a typical IXS spectrometer and many other X-ray instruments that require excellent energy resolution combined with a large solid-angle coverage for scattered photons. To maximize energy resolution and angular acceptance while minimizing geometric aberrations, spherical analyzers are typically operated in near-backscattering conditions, where the Bragg angle of the incident radiation is close to  $90^\circ$ . These spherical analyzers are initially manufactured from a flat crystal wafer, which is diced into close to 10,000 pixels and bonded to a spherical glass lens. This process results, in essence, in an ordered assembly of a large number of tiny, perfect crystals with all their diffracting surfaces aligned along a sphere of a prescribed radius, and all surface normals pointing to a common focal spot. Radii can vary from 6 to 10 m for high-resolution applications and 1 to 2 m for less-demanding applications.

In the figures below, a spherical analyzer for high-energy resolution (1.5 meV) and high incident energy (23.7 keV) is shown in its various stages of manufacturing. From left to right is the diced silicon wafer, a rocking curve giving a measured resolution of 1.5 meV, and the wafer bonded to the spherical glass lens together with a close-up of the pixel structure. Due to the larger penetration depth of high-energy X-rays, the crystal wafer in this case has to be several millimeters thick and the dicing into pixel has to proceed in two steps: First, a thick cutting blade is used from the back side to cut about halfway into the material; then, to minimize loss of surface area, a thin blade is used from the diffracting side to finish.

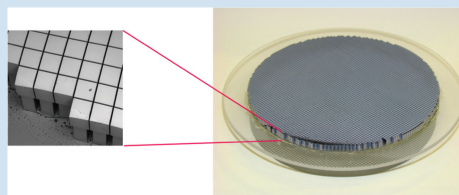
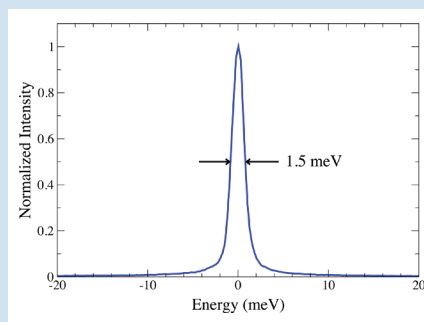
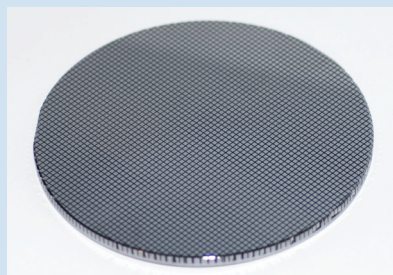

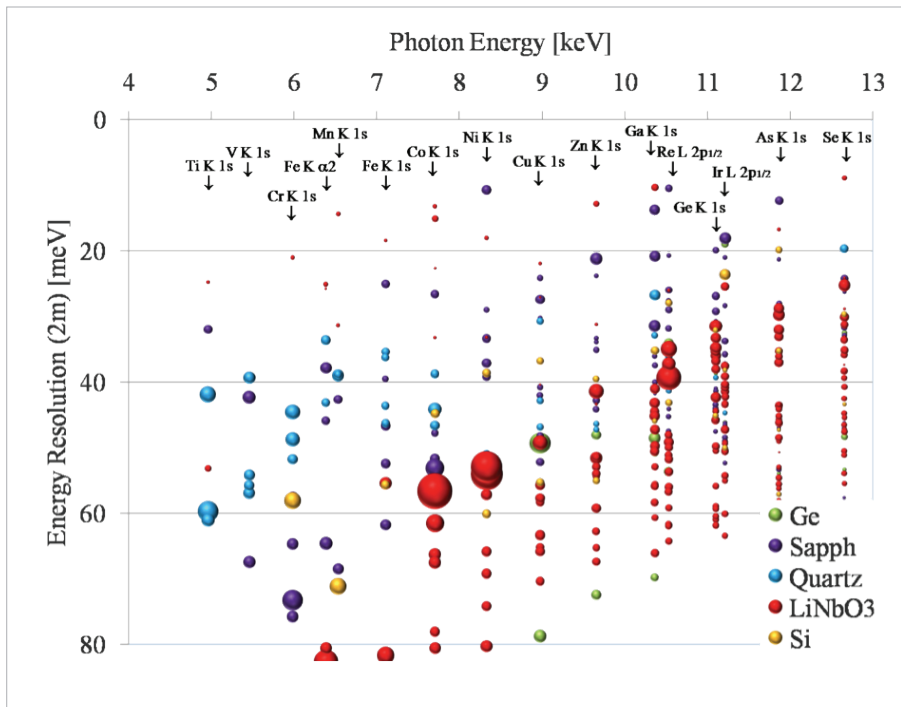

The energy resolution that can be obtained as a function of energy for various analyzer crystals (with a 2-meter analyzer-to-sample distance). If constrained to use only silicon (yellow circles) only a few discrete energies are achievable with energy resolutions typically below 20 meV. If other crystals (germanium, sapphire, quartz, lithium niobate, for example) were available with the necessary perfection and size, the absorption edges of many more elements could be used for RIXS with resolutions less than 10 meV. The size of the circles is proportional to the expected intensity. (Adapted from reference [4])

achieving strain-free mounting with good thermal transport. Furthermore, although significant improvements have been made, sizes of defect-free regions still pose a problem for applications that require small d-spacing variation over extended volumes, e.g., in the case of a Bragg-scattering geometry at higher energies where beam footprints can exceed 10 mm<sup>2</sup>. Improving crystalline diamond to mitigate these issues would allow the exploitation of its other outstanding properties and allow it to outperform silicon in high-heat-load applications.

## R&D Directions for the Future

Single-crystal diamond X-ray optical components will clearly find increased usage in current and future X-ray light sources. Whether for high-heat-load monochromators, transmission monochromators, beam splitters, or as potential mirrors for X-ray oscillators, there is a need for the development of a reliable source of high-quality diamonds of various orientations and sizes.

Currently, RIXS is severely limited by the unavailability of energy analyzers that perform well at specific X-ray energies (e.g., near-atomic absorption edges). RIXS relies on the resonant enhancement of the IXS signal to make measurements feasible that would be more difficult or perhaps impossible in a nonresonant mode. The bulk of RIXS measurements to date have been collected at 3d-transition-metal edges, driven by the recent interest in correlated electrons associated with magnetoresistance in manganites, and superconductivity in cuprates. Fortunately, silicon analyzers could be used for these applications. But to expand the scope of applications, suitable analyzers must be developed that operate at a variety of specific X-ray energies

polishing, and bonding to spherical substrates — have been solved with varying degrees of success, but fabrication results are inconsistent. This relatively low success rate (<50%) in analyzer fabrication is costly in terms of time, money, and signal rates. As spectrometers are upgraded or newly designed, there is a growing trend to significantly increase the number of analyzers to compensate for the low signal rates, or to access a large number of X-ray energies in the case of RIXS, leading to an acute demand for a large number to be successfully fabricated. Hence a concentrated effort to improve the fabrication process of high-resolution X-ray analyzers is needed. Processing improvements should include bending accuracy, optic long-term stability, and increasing production capacity while maintaining adequate quality.

In addition to crystal quality, available sizes of high-quality material can impose limitations on their use. As previously mentioned, crystalline diamond is not available in large, monolithic sizes and this leads to difficulty in

(corresponding to absorption edges) that have good energy resolution and high efficiency.

- **Develop alternative crystalline materials (other than silicon) for X-ray optics.** This should include discussions with academic and industrial crystal growers to identify potential materials that might be candidates for the growth of large, high-quality single crystals and then collaborating with those growers to assist in the X-ray characterization of the crystals.

Data collected using high-resolution inelastic X-ray analyzers are used for sound-velocity measurements and the determination of the elastic and viscous properties of materials at ambient or under extreme (high pressure, temperature, etc.) conditions. These results can be extremely valuable for scientists studying the Earth's interior or condensed-matter physicists looking at dispersion relations of elementary excitations including phonons, magnons, and spin-density waves. To collect this data in reasonably short times with adequate statistics, arrays of high-resolution analyzers are employed. Current analyzer-fabrication techniques are highly labor-intensive and not optimized, resulting in degraded energy resolution. This situation needs to be changed.

- **Improve the fabrication process of X-ray energy analyzers.** Processing improvements should include bending accuracy, optic long-term stability, and increasing production capacity while maintaining adequate quality.

Future source properties that impact R&D in crystal optics include higher X-ray power, such as is expected with upgrades of existing facilities, or more significantly, new facilities (e.g., ultimate storage-ring concept with long straight sections), and short-pulses (~100 fs) as delivered by XFELs. X-ray beam coherence also comes into play with all sources as it improves with source brightness up to the full coherence delivered by XFELs. Seeded XFELs offer the potential for the highest spectral brightness and along with it a significant challenge for secondary monochromators to withstand higher peak-power loads. Crystal optics will need to operate well under these conditions in order to fully exploit the scientific possibilities presented by future X-ray sources.

- **Explore the limit of both high-average-power and high-peak-power X-ray beams incident on crystal optics and the crystal-optics requirements for preservation of X-ray beam coherence.** The effect on the performance of single-crystal optical components in terms of both the long-term (days) and short-term (femtoseconds) structural stability of the crystalline lattice under these power loadings must be further studied. In addition, the effects of fabrication processes, thermomechanically induced strain, and crystal inhomogeneities on coherence preservation should be further explored.

These three principal areas of development in crystal optics are important for either resolving issues presented by future source properties or overcoming instrument limitations already present at current sources. Developing solutions to these issues will require R&D in various aspects of crystal optics. Executing these research directions will move the field of X-ray optics forward and, when combined with future X-ray sources, will significantly extend X-ray measurement capabilities within the DOE complex.

## Impact

Because crystal X-ray monochromators are so ubiquitous, it is imperative that they operate effectively and efficiently. Presently, hard X-ray beamlines often use LN<sub>2</sub>-cooled silicon as the first optical component; however, if large, perfect diamond crystals were readily available, it could have a significant impact on HRLM design.

There is no doubt that future X-ray sources will lead to even larger average and peak thermal loads on HRLMs, HRMs, beam splitters, and any other optic in the X-ray beam path. For example, high-powered, short-pulse-length X-ray sources may affect diffraction behavior in unwanted ways and/or adversely affect the stability of the crystal lattice. This area of research is essentially new to the field of X-ray crystal optics, so there is need to explore the limit of high X-ray incident power (including high electric fields) on crystal diffraction in terms of both structural stability and short-term time response. Also, minimizing the disruption to the coherence of the X-ray pulse has become increasingly important for high-brightness sources, and determining the limitations of

crystal optics as applied to coherence-sensitive measurements will increase in importance as new fully coherent X-ray sources come on line.

Because RIXS is element-specific, it is an extremely powerful tool and in fact can distinguish the same element at different crystallographic sites within the sample. The power of the RIXS technique has made it an attractive tool for the study of charge, spin, and orbital degrees of freedom. Resonant inelastic X-ray techniques are hampered by the limited availability of energy analyzers that perform well at specific X-ray energies (e.g., near-atomic absorption edges). However, the development of alternative crystalline materials (other than silicon) for X-ray optics will help to mitigate this problem. To date, most experiments have been at ambient conditions but RIXS at extreme conditions (temperature, pressure, etc.) or in thin films or surfaces will require even more efficient monochromators and analyzers for success.

Nonresonant IXS does not have the specific energy requirement of RIXS, but because it is nonresonant, the count-rates are very low. Arrays of analyzers are often employed. Improvements in the fabrication process of X-ray energy analyzers, including bending accuracy, optic long-term stability, and increasing production capacity while maintaining adequate quality, will support the advancement of inelastic X-ray studies in the hard X-ray region. Future X-ray sources with significantly higher spectral fluxes coupled with improved high-resolution optics could have enormous scientific impact. This can lead to a renaissance in X-ray measurements of lattice as well as electronic and atomic interactions, on a variety of timescales.

## References

1. T.S. Toellner, A. Alatas, and A.H. Said, *Six-reflection meV-monochromator for synchrotron radiation*, J. Synchrotron Rad. 19 (Pt 4), 605-611, 2011.
2. M. Yabashi et al., *X-ray monochromator with an energy resolution of  $8 \times 10^{-9}$  at 14.41 keV*, Rev. Sci. Instrum. 72, 4080-4083, 2001.
3. T.S. Toellner et al., *Crystal monochromator with a resolution beyond  $10^8$* , J. Synchrotron Rad. 8, 1082-1086, 2001.
4. T. Gog et al., *Spherical analyzers and monochromators for resonant inelastic hard X-ray scattering: A compilation of crystals and reflections*, J. Synchrotron Rad. 20, 74-79, 2013.
5. J. Kim et al., *Magnetic excitation spectra of  $SR_2IrO_4$  probed by resonant inelastic X-ray scattering: Establishing links to cuprate superconductors*, Phys. Rev. Letts. 108, 177003, 2012.



# Thin Film Optics



20 nm

## Summary

Thin films have a wide variety of applications and have infiltrated many segments of everyday life, including antireflective coatings on automotive glass, wear-resistant additives on tooling, the microelectronics industry, and power generation. Over the past few decades, their use in X-ray optics has steadily increased. As thin-film technology has advanced from the simplest evaporation and vapor-condensation methods to modern plasma processes, the performance of thin-film-based X-ray optics has been greatly improved, along with a similar widening of the breadth of their application. As the science conducted at present and future light sources continues to be developed, more demands are placed on thin-film-based optics. R&D on many issues is

currently under way at several facilities. The following section highlights four main research directions for their broad-ranging impact on current and future science needs at DOE light sources and the need to augment ongoing work.

### Working Group Chairs:

R. Conley (ANL/BNL)

R. Soufli (LLNL)

### List of contributors in alphabetical order:

A. Aquila (XFEL, Germany)

Y. Cai (BNL)

E. Dooryhee (BNL)

S. Hau-Riege (LLNL)

J. Larruquert (Instituto de Optica  
CSIC, Madrid, Spain)

A. Macrander (ANL)

C. Morawe (ESRF, France)

M. J. Pivovarov (LLNL)

Y. Platonov (Rigaku, US)

H. Takenaka (Toyama Corp., Japan)

D. Voronov (LBNL)

D. Windt (RXO LLC)

### RECOMMENDATIONS

- 1. Comprehensive investigation of the physics of thin-film growth, interfaces, and atomistic modeling is necessary to advance performance of all thin-film optics, including structured coatings, ultrashort-period multilayers, and Laue lenses.** An improved understanding of the materials science of thin-film growth and the physics of interfaces is required in order to provide solutions to many of the issues found with thin-film X-ray optics. Simulation and modeling can be used as a powerful tool to advance the performance of all types of coatings for many applications, including reflective and structured coatings, ultrashort-period reflective multilayers, and multilayer Laue lenses (MLLs). Along with simulation, new material systems for multilayer growth must be experimentally investigated and verified. Such research will enhance all current science applications at light sources, while enabling new science such as efficient normal-incidence imaging at short wavelengths for applications such as X-ray microscopy.
- 2. R&D is needed on damage origins, mitigation, recovery, and lifetime enhancement of coatings used in extreme environments.** New types of X-ray light sources (fourth-generation synchrotron source, free-electron and plasma-based lasers) are imposing new, unprecedented requirements on reflective coatings. The physics of each light source determines the reflective properties and damage mechanisms of reflective thin-film materials. For example, the photon energy range of the light source determines the refractive index, reflectivity, and penetration depth properties of materials and affects the types of materials damage such as phase change, ablation, and other mechanical damage. Concurrently, the peak power, average power, and fluence of the light source greatly influence the types of damage that may occur. X-ray damage, thermal damage, and the repetition rate of the source also greatly influence the type of damage. Proposed multi-MHz free electron lasers (FELs) will impose new and challenging damage mechanisms due to repetitive strain.

### Multilayer Thin Films Give High X-ray Reflectivity at High Grazing Angles

Multilayer thin films consist of alternating layers of high-Z (atomic number) and low-Z materials such as W/C or Si/B<sub>4</sub>C. X-rays reflected from each high-Z layer interfere constructively, as in Bragg diffraction from a crystal, and yield high reflectivity.

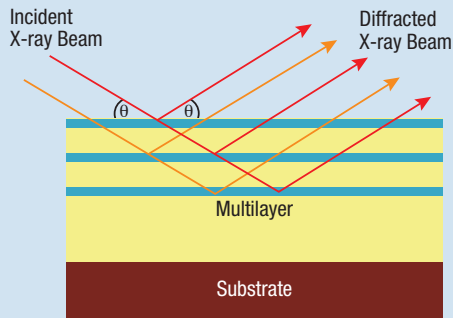

Multilayer mirrors can have high normal-incidence reflectivity in the EUV and high grazing-incidence reflectivity above the critical angle of a single layer in the hard X-ray region. Left: a mirror for EUV lithography; these types of mirrors can have very high normal-incidence reflectivity (right). (CXRO / LLNL)

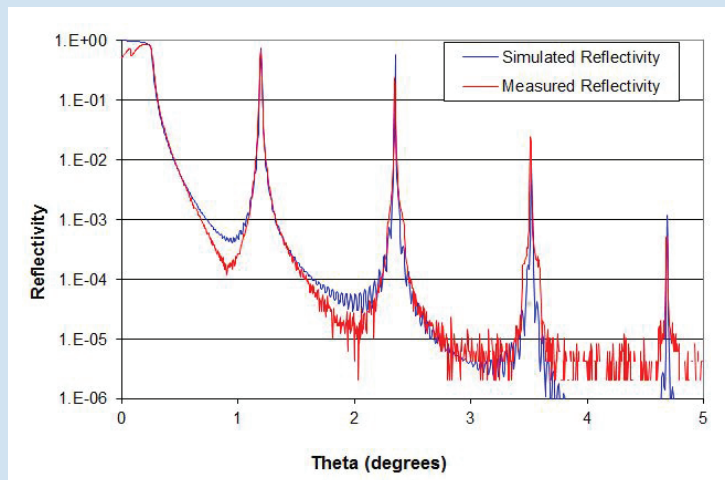
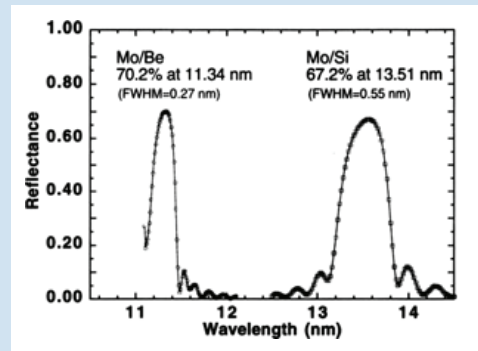
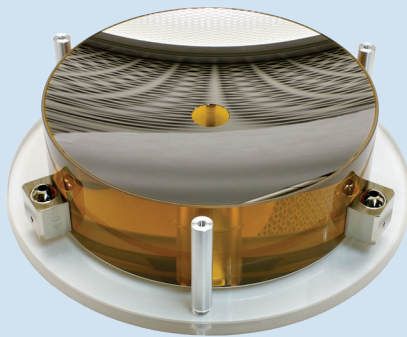

This figure shows the reflectivity of a narrow bandpass multilayer mirror at around 8 keV photon energy [1].

- 3. Investigation of methods for 3-D multilayer deposition on highly profiled surfaces will enable the use of new optical geometries and allow for higher efficiency and mirror figure correction.** Modern deposition techniques are capable of precise thickness control along one axis. However, the production of true 3-D thickness gradients remains elusive. The ability to produce reflective multilayers with a period change along both axes of a paraboloid, for example, will allow a single-bounce optic to perform collimating or focusing in both axes. This technology could also be deployed for mirror figure correction or modification with either additive or subtractive methods. A successful investigation of this issue will improve or enable new science, utilizing new forms of inelastic X-ray scattering (IXS) and small-angle X-ray scattering (SAXS).
- 4. Multilayer Laue lens research, including stress reduction, larger thicknesses, manual thinning, focused ion-beam milling, and mounting, needs augmentation. The results of this effort will be applicable toward other thick or diffractive multilayer optics.** “Thick” or diffractive multilayer thin films (for example, Laue lenses) have recently made great strides in relation to both total aperture and deposition-thickness control. Intensive R&D programs are already under way. Continued improvements in stress reduction, larger thicknesses, manual thinning, focused ion-beam milling, and mounting will provide higher resolution and efficiency as required for science experiments involving nanofocusing or diffraction.

## Scope

Single-layer and multilayer thin-film coatings, employed as reflective or diffractive elements in X-ray mirrors, monochromators, focusing or collimating elements, gratings, zone plates (ZPs), and Laue lenses, find prolific use at all DOE light sources. This chapter discusses the requirements and challenges for thin films. By combining research into new materials, deposition methods, thin-film and surface science, atomistic modeling, and nanofabrication techniques toward solving problems with current thin-film optics, we seek to provide the next generation of optics for X-ray science.

In the X-ray and extreme ultraviolet (EUV) wavelength regions, the refractive index of all materials is less than 1. This means that the reflectivity from a single layer of any material at grazing-incidence angles below the critical angle (ranging from 5 degrees for soft X-rays to typically 0.15 degrees for hard X-rays) is close to 1 and for angles above the critical angle, falls rapidly to zero. Multilayer interference coatings function as “quarter-wave” stacks. They take advantage of the constructive interference of the electric field of light traveling across multiple-layer interfaces (ranging from tens to thousands in number) to produce reflectivity values approaching 1 at incidence angles above the single-layer critical angle, up to near-normal incidence angles. Multilayer interference coatings also act as narrowband or broadband reflective filters, reflecting light in a specifically tailored region of wavelengths and suppressing light at all other wavelengths. In this manner, multilayers enable a plethora of science applications including solar physics, astrophysics, plasma and high-energy physics, semiconductor

### Multilayers Have Been Used in Many Fields, from Synchrotron Radiation Research to Satellite-Based Astronomy

**Top:** A pair of multilayer mirrors, part of an imaging telescope aboard NASA’s Solar Dynamics Observatory (SDO). Each mirror consists of a superpolished glass substrate coated with two different multilayer thin films (with each film occupying half of the mirror) designed to reflect at two different EUV wavelengths. The multilayer peak wavelength must be matched to within a few angstroms across each curved mirror surface, requiring exquisite multilayer thickness control. (*Regina Soufli, LLNL*)

**Bottom:** High-resolution EUV images of the solar corona at a range of temperatures. (*NASA*)

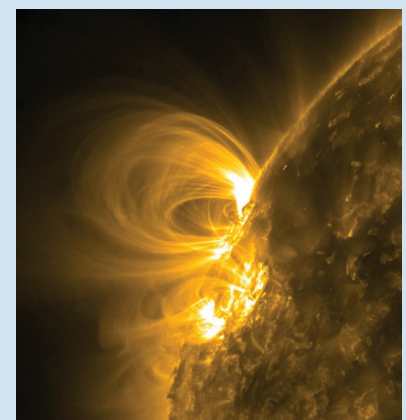
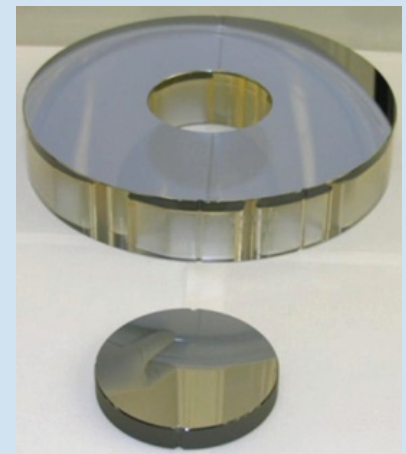

photolithography, X-ray microscopy, and materials science. When operated in transmission or diffraction mode, multilayer thin films can be employed for nanofocusing (called multilayer Laue lenses) to provide spatial resolution and efficiency much higher than is currently achievable with lithographically produced ZPs. Multilayer thin films may also be used as efficient polarizers, in reflective and/or transmissive mode. Depending on the science application, an X-ray thin film can be as simple as a single-layer mirror coating, or a complex array of thousands of layers deposited on top of one another. Universally, the thickness of each layer must be controlled with precision well below 0.1 nm and the layer interfaces must be close to atomically smooth and remain stable over time in the operating environment of the thin film. There are a wide variety of thin-film-based optical elements. Solutions found for one thin-film-related issue can often be applied to other types.

Thin-film deposition techniques such as DC and RF magnetron sputtering, ion-beam sputtering, and electron beam/thermal evaporation are reaching maturity, with ongoing technical improvements. Deposition methodologies with ultraprecise lateral uniformity control (30 pm rms) for wavefront preservation and spectral matching have been demonstrated. Period thickness accuracy of a few pm peak-to-valley has been achieved on graded multilayers. The task of ultraprecise thickness control becomes more daunting with increasing optic size, but is a tractable problem that will require evolutionary, not revolutionary progress. Many material systems have been utilized for multilayer coatings, and the material system selection process necessarily agglomerates several design factors. X-ray characterization techniques and wave-optical modeling of the performance of single-layer and multilayer thin films are well established, with reliable results. Recovery strategies (using UV-ozone and plasma techniques) to remove contamination blemishes from thin-film coatings exist, but only for a limited subset of thin-film coatings. Significant progress has been made recently on the development of new material system combinations and deposition processes that combine both low interfacial roughness and low stress for MLL fabrication.

## Issues

Multilayer optics were first developed around 37 years ago for deep UV applications [2], but it was recognized at that time that they would have wide impact in EUV, soft X-ray, and hard X-ray applications. Indeed, within a short time, multilayer optics were rapidly taken up by the X-ray optics community for a range of applications, from simple wide-bandwidth monochromatization of hard X-rays to EUV and soft X-ray astronomical imaging. The present generation of applications for light sources is posing new challenges, and here we highlight several of the most pressing issues.

- **Better understanding is needed using modeling and simulation of the physics of thin-film growth, material systems, deposition processes, and interface engineering in order to advance the performance of all thin-film optics such as structured coatings, ultrashort-period multilayers, Laue lenses, and gratings.** Multilayer material systems and deposition processes are mostly chosen empirically, based on experience, incorporating a wide array of design considerations. These include the desired energy of operation, angle of incidence, spectral rejection characteristics, and environment, to name a few. Existing solutions are adequate for only a limited region of this parameter space.

Thin-film materials often have distinctly different properties from their counterpart bulk materials. Experimental knowledge of the refractive index of materials is largely lacking in the EUV and X-ray photon-energy range, especially for compound materials in the vicinity of electronic absorption edges. Moreover, fundamental understanding and manipulation of the physics of thin-film growth, especially at the layer interfaces (for example to control stress, roughness, and smoothening properties) is highly needed for developing reflective thin films with tailored properties. This understanding can be achieved with a combination of theoretical calculations, atomistic simulations, and dedicated experiments for measuring fundamental parameters and verifying theoretical models.

Multilayer gratings pose a particularly important problem, as they represent a good route to ultrahigh-energy soft X-ray spectroscopy, with applications for example in resonant inelastic X-ray scattering (RIXS) [3]. The main problem is that the structured surface can be rapidly smoothed out in normal deposition conditions. To avoid this problem, atom energies on the surface are reduced by various methods, but this leads to an

enhancement of interface roughness. Achieving conformal coatings on grating substrates remains a significant challenge, and atomistic simulations could have a major impact in speeding the development of these complex optics.

- **The large power of modern light sources poses novel challenges for the survivability and reliable operation of X-ray optics and often does not allow large safety margins in their design.** Optics damage processes can be roughly categorized into two groups: single-pulse damage to the optical materials, such as melting, and other phase changes, such as fracture; and spallation, which forces an upper limit to the X-ray threshold fluence. Further, even below the single-pulse-damage threshold, the optics performance could be degraded through various processes, including cyclic thermal fatigue of bulk materials and interfaces, thermal deformation of the optics, and changes in the lattice constants, cumulative photochemical processes such as bond breaking and amorphization, and surface-chemical reaction leading to the removal or deposition of material [4,5].
- **Multilayer thickness gradients are typically one-dimensional (linearly, radially, etc.) because advanced deposition methods for quasi-arbitrary 3-D thickness profiles do not exist.** Thin-film growth on highly profiled substrates with a complicated surface structure such as highly corrugated surfaces for gratings, steeply figured mirrors with 3-D figures (for example true paraboloids), or wires has been explored for years, but the ideal solution has not yet been found. The multilayer needs to precisely follow the substrate figure or features while maintaining high optical contrast. Often, processes that produce multilayers with high-quality interfaces exploit energetics that have high intrinsic mobility, causing poor replication of the initial substrate features. Deposition on highly curved substrates with traditional techniques typically produces poor interface quality as the growth transitions from normal-incidence to glancing-incidence. One method for mirror figure correction is to mill the substrate with a sub-aperture ion beam. The corollary to this with coating could also be used for figure correction, as well as for other specialized coatings such as for stress modification or variable reflectance.

### Multilayer Films Can Be Optimized for Different Applications

Multilayer mirrors can be optimized for a range of purposes. In this example, optimization is achieved so that a flat reflectivity response is obtained over a range of angles (or wavelengths) [1].

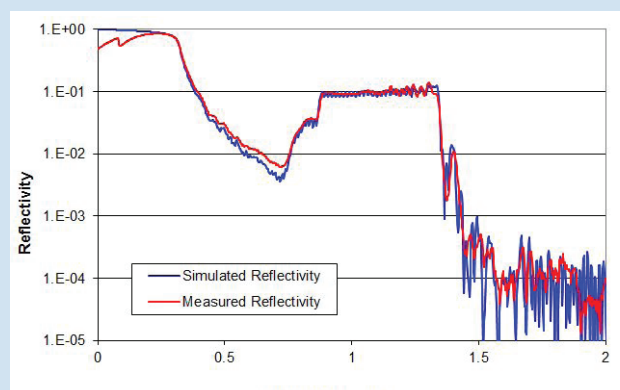

This optimization is made by changing the periodicity of the multilayer stack, and the relative thickness of the high-Z and low-Z components. Below: An aperiodic multilayer optimized for broad bandpass applications. (CXRO)

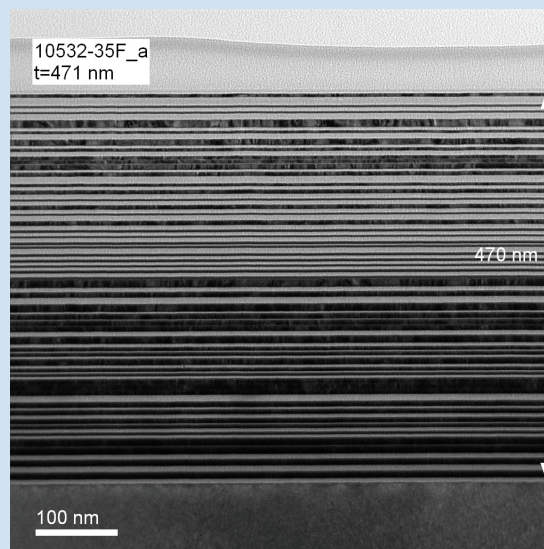

- **The origin of coherence distortion from multilayer mirrors is not yet understood.** Coherence preservation is another related issue with modern light sources. Many scientific studies exploit the high coherence available with modern sources. Although it has been noted that features are imposed on the wavefront from a multilayer reflection, the source of this contribution remains unclear. The reflected wavefront interacts with the entire optical element, which is composed of the coating material, all multilayer interfaces, as well as the substrate-polishing figure and finish imperfections, which propagate through the entire multilayer stack. One possibility is that substrate-polishing imperfections are magnified, since the reflection angle with a multilayer is larger than what is typically used with single-layer metal-coated mirrors. To take full advantage of multilayers for flux-hungry coherence experiments, the source of these wavefront distortions must be identified and resolved.
- **Cryocooled multilayer optics are not yet mature.** Cryocooling of crystals in a double-crystal monochromator under high-heat-load conditions is a well-established technology. However, the same cannot be said for cryocooling of multilayers or single thin films. The technology is only in its very early stages. The possibility of obtaining large increases in flux through the use of multilayers would be of great benefit to many high-power beamlines; however, little work has been done to investigate the behavior of coatings when cycled between room temperature and cryogenic temperatures.

Many scientific areas could benefit from solution of the problems identified above. For example, the speckle caused by imperfections in the local characteristics of multilayer mirrors limits many imaging experiments. These problems will become much more significant with FELs and diffraction-limited storage rings, where true phase-front preservation will be required. Peak-power and repetitive-strain issues will clearly limit the application of multilayers in FEL instrumentation if solutions to damage problems are not found. High-order gratings using multilayer coatings may be crucial new elements for ultrahigh-energy resolution RIXS, but today their performance is limited in the soft X-ray region by the lack of coating conformity. The solution to these problems will directly impact a broad range of science carried out across many of the DOE facility beamlines.

## R&D Directions for the Future

This section outlines some promising R&D directions to address the issues identified above. Although in general they are interconnected, we separate them to show the main thrusts of any projected R&D program.

- **Software, modeling, and simulation.** The modeling and simulation of optical-element performance is a mature field, ranging from simple ray tracing to phase reconstruction and wave optics. Specialized software for the simulation of reflective multilayer performance is freely available [6] and widely used. New methods such as phase reconstruction show real promise and are actively being pursued by several groups. Algorithms for the design of depth-graded multilayers optimized for arbitrary reflectance profiles are effective and proven. Modeling of masking for profile coating and differential deposition velocity profiling is routinely employed for many source types and deposition geometries. Genetic evolution software for material-system selection based on optical properties has also been developed.

It should be noted, however, that all these software solutions attempt to design an optical system based on empirical knowledge of what the performance envelope is for a given thin film or multilayer. In general, performance improvement of existing growth techniques is slow and expensive. Many parameters that would produce better-quality X-ray optics such as smaller layer thicknesses, sharper interfaces, lower stress, environmental stability, or conformal coatings will only improve with new knowledge of the materials science of the systems used.

Long-term efforts for molecular dynamics and atomistic modeling of deposition processes are being pursued in a number of laboratories [7, 8]. The modeling of plasma processes has been used, for example, in the semiconductor-fabrication industry to great effect. However, little has been done to utilize these existing tools to find innovative solutions to X-ray optics problems. Although such an effort may not yield immediate results, the benefit of modeling processes first, and then experimentally verifying the model, as opposed to the other way around, is very clear and will likely yield results across the entire range of thin-film X-ray optics.

Key issues such as damage mitigation, film stress, conformal deposition, and interfacial roughness are intertwined. Performance of multilayer gratings is limited because typical deposition techniques rely on added surface energy to smooth the film and fill voids. This also leads to poor grating-profile replication, and thus, lower efficiency. Experimentally testing new techniques and recipes is very slow and expensive. Multilayer growth simulation may be able to point to new methods of deposition that exploit the directional geometry of gratings to provide better profile replication without sacrificing interfacial roughness. Microstructured thin-film techniques may be able to produce the required grating figure more precisely than conventional etching techniques.

To address the replication problem, a thorough investigation of the process of the multilayer growth on highly profiled substrates should be performed. The growth process should be studied experimentally and theoretically with simulations of the deposition process. The traditional deposition strategy should be reconsidered in terms of the optimization of the growth for highly structured surfaces. The important factors affecting multilayer growth are collimation of a flux of deposited particles, precise control of an average energy and an energy distribution of particles arriving to a substrate, deposition geometry, proper choice of materials, etc. Extensive R&D efforts are required for both deposition tools and deposition processes. Successful realization of the program would result in development of highly efficient and ultradispersive multilayer gratings and precise beam-shaping multilayer mirrors.

In the hard X-ray regime, common transmission geometry measurements probe a cross section, or gauge volume where individual contributions are difficult to deconvolute. The measurement of well-resolved locations within a material, or the ability to probe separately different components within a multicomponent or layered device such as an electrochemical cell or battery, requires the penetrability that only high-energy X-rays can provide, along with high spatial resolution. In order to provide sufficient 3-D gauge volume probing, the X-ray beam must be carefully focused with a high efficiency. The requisite multilayer has a precisely controlled period gradient along the entire optical aperture of the mirror. State-of-the-art deposition systems incorporate precision substrate-translation systems for accurate differential deposition, where the deposition flux is convoluted with a desired thickness gradient in order to calculate a velocity

### Multilayer Thin Films Need Improvement

Multilayer thin films suffer from a range of issues that limit performance. One fundamental issue is interdiffusion between the low- and high-Z layers. This becomes more of an issue as the period of the multilayer decreases.

**Left:** A 7 nm period Mo/B<sub>4</sub>C multilayer has slightly blurred interfaces due to crystallization and interdiffusion. The effect on reflectivity is relatively minor due to the large period. **Right:** In the case of a WC/SiC multilayer with 1 nm period, the interdiffusion is extreme and there only remains a small electron-density modulation between each layer (*R. Soufli, LLNL*). Interface engineering through use of ultrathin diffusion barriers and control of surface energy during deposition could mitigate these issues.

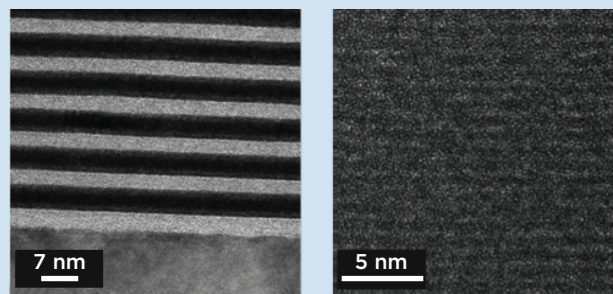

**Below left:** Shadowing and surface diffusion during deposition causes initially conformal layers on a grating surface to become rounded and can also lead to roughness. This limits diffraction efficiency. Control of the ion energy and direction can help limit this effect [3].

**Below right:** Defects within the multilayer, such as regions of changed density due to crystallization causing minute local deformations of the film, cause phase errors typically seen as a speckled pattern in the far field.

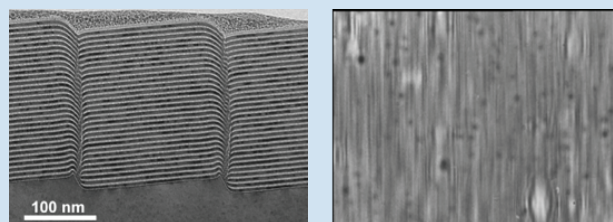



profile. This method is fully capable of producing multilayer d-spacing gradients with accuracies well above what is required. This does not, however, mean that the intrinsic deposition process is capable of producing a multilayer without other problems. Intrinsic film stress can be a function of many parameters, including material interface, thickness, and temperatures, to name a few. This film stress can cause a nonlinear warp of the substrate figure. The deposition environment can be modified to help reduce this stress; however, these often change other characteristics of the film such as interfacial roughness or deposition rate. Detailed simulation is necessary so that higher-performance multilayers with a combination of high efficiency, low film stress to reduce substrate warping, and low interfacial roughness can be produced.

- Damage control, mitigation, and recovery.** A type of damage worthy of special study occurs after installation of thin-film-coated optics at the light source, caused by the interaction of the top surface of the coating with the incident beam, combined with environmental conditions. Typically, carbon-based contamination “blemishes” develop on the coating surface over time, ultimately degrading the coating performance to an unacceptable level and leading to replacement of the coated optic. In this case, accurate knowledge of the environment and the photochemical processes taking place during interaction of the beam with the coating surface is crucial to improving the damage resistance and ultimately the lifetime of thin-film-coated X-ray optics. Complementary to this approach, coating recovery strategies (in and ex situ) are needed. An additional challenge in the development of recovery methods is posed by carbide coatings recently developed for the LCLS FEL mirrors and gratings, in which carbon exists in both the blemish (that needs to be removed) and the coating (that needs to be preserved) [4]. FEL light also causes damage due to the stress and thermally driven processes that cause layer intermixing, and in extreme cases surface ablation. Other light-source environments and/or materials may lead to extreme conditions such as corrosion. For example, magnesium-based high-reflectance multilayer coatings have suffered from atmospheric corrosion, which erodes the coating over time. After the origins and mechanisms of corrosion were elucidated, protective corrosion barriers were developed that rendered the coatings corrosion-resistant while preserving their reflective performance [9]. Unique light-source needs will likely require individual damage-control solutions.

### Single and Multilayer Thin Films Can Be Damaged by a Range of Mechanisms

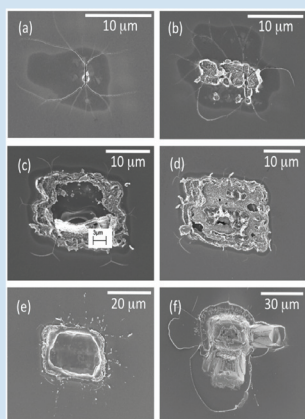

Multilayer and single-layer thin films can be damaged by thermal stress, thermally driven interdiffusion, impulsive thermal ablation, and many other mechanisms. Here SEM images show damage to a SiC film on a Si substrate, exposed to single LCLS FEL pulses at 0.83 keV and peak fluences of (a) 1.0, (b) 1.6, (c) 2.9, (d) 5.8, (e) 14.8, and (f) 57.5 J/cm<sup>2</sup>. [5]

Multilayer mirrors can also be damaged by corrosion. **Left:** An SEM image shows the top surface of a standard Mg/SiC multilayer coating with atmospheric corrosion. Portions from the top few layers of the film are delaminating, or are missing entirely. **Right:** A cross-sectional TEM image of the top layers of a corrosion-resistant Mg/SiC multilayer. The corrosion barrier consists of an intermixed, partially amorphous Al-Mg layer deposited underneath the top SiC layer. Crystalline Mg and amorphous SiC layers are also shown. The multilayer period is designed for operation at wavelengths around 46 nm at near-normal incidence angles [9].

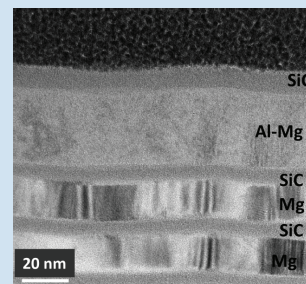
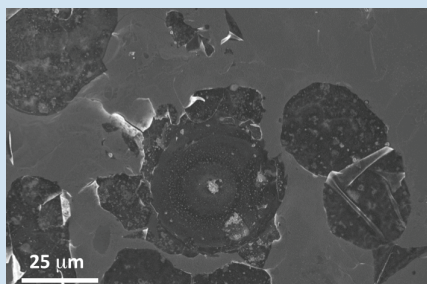

- **3-D multilayer deposition on highly profiled substrates.** The most prevalent nanofocusing or collimating multilayer mirrors are two-bounce components because the technology for polishing a mirror substrate is most successful for flat or single-axis curvature mirrors; multilayer-deposition thickness gradients are then intrinsically 1-D. The deposition process only needs to be 1-D because of mechanical considerations. Deposition source flux profiles are easily quantified and mapped in order to calculate flux masks or velocity gradients. The addition of a dynamic system that can somewhat arbitrarily alter the deposition flux profile during a coating will add an extra degree of freedom needed to deposit films in a sub-aperture mode. Coarse methods for this exist; however, none are sufficient to provide the high precision required for X-ray multilayer coatings. An effort to design and implement a 3-D film gradient will allow fabrication of not only highly efficient collimating or focusing elements, but also figure correction or modification.
- **Multilayer Laue lens (MLL).** Diffractive thin-film optics are devices in which, once a multilayer structure is deposited, it is typically sectioned or thinned to produce a transmission optic. The majority of this work has revolved around fabrication of nanofocusing elements; namely “jelly-roll zone plates” and MLLs [10, 11]. Such devices are intended to overcome two major difficulties in the conventional lithography fabrication of zone plates (ZPs): small zone width and high aspect ratio, which limit the resolution and efficiency a ZP can achieve.

MLL and jelly-roll ZPs are an emergent class of nanofocusing X-ray optics, in which thousands of individual layers are deposited on a flat substrate (MLL) or small wire (jelly-roll ZP) according to the Fresnel ZP equation, and then sectioned. An MLL section, when illuminated in transmission mode, will focus a plane wave into a line. If a pair of MLLs is used in a crossed geometry, a point focus can be obtained. Since a jelly-roll is radially symmetric, only one thinned plate is required to focus to a point; this behavior is identical to traditional ZPs. As thin-film-deposition techniques can easily produce atomically thin layers, and the stack can be sectioned to an arbitrary thickness by several methods, these devices are not limited by these two factors, but by other issues such as layer-placement error, accumulated film stress, sectioning damage, and mounting. Jelly-roll structures have been attempted numerous times by several groups with varying degrees of success. Just as with standard reflective multilayers, any errors on the substrate will propagate through the entire stack. Jelly-roll structures require a wire with radial uniformity that is no larger than one-third the outermost zone width. Also, uniform deposition onto a wire means that normal-incidence film growth only happens on a small fraction of the wire at any point in time. This means that there is a tendency for an increase in roughness in the off-normal regions. Due to these two main issues, the MLL, where the structure is linear in geometry, is much more promising for ultrahigh resolution.

State-of-the-art deposition instrumentation appears to have the stability and repeatability required for diffraction-limited MLL deposition. Marker-layer incorporation indicates that layer placement is no longer a problem, and reactive growth has reduced film stress, but more needs to be done to produce ever-larger structures. Existing efforts worldwide have deployed only a limited set of materials such as  $\text{WSi}_2$ ,  $\text{MoSi}_2$ , Si, Zr, and Al. Comprehensive investigation into new materials will expand the useful X-ray energy range and accommodate more robust sectioning geometries. Wedged MLLs have been fabricated, and the next logical extension to these — elliptical MLLs — are possible, both with the same coating techniques.

- **Multilayer optics post-processing and sectioning.** Techniques for sectioning with plasma-based processes and manual polishing require refinement in order to produce usable optics. Bonding of two MLLs will produce a true monolithic 2-D focusing element, reducing the mechanical complexity of beamline microscopes. Reactive-ion etching facilities are able to produce sectioned structures with high mechanical stability, however a focused ion beam (FIB) instrument is needed that is dedicated to optics fabrication. This will open the path to development of novel sectioned optics. The same techniques that are used for MLL sectioning are easily transferable to other types of optical elements, such as binary pseudorandom multilayers, high-throughput transmission gratings, and sectioned multilayer blazed gratings. Free-standing multilayer elements can also be sectioned with manual polishing in a transmission electron microscopy (TEM)-like procedure. However, adhesive bonding of extremely thin structures warps the structures, so alternative means of bonding such as thin-film soldering should be investigated.

## The Multilayer Laue Lens Is a Revolutionary New Focusing Element That Promises nm Resolution at Hard X-ray Energies

Zone plates are limited in focusing hard X-rays by the large absorption length required to stop light by the opaque or phase-shifting zones. As the resolution is approximately the width of the outermost zone, hard X-ray zone plates must have extreme aspect ratios of outer-zone width to thickness. In practice, resolution with good efficiency is limited to 50 nm for hard x-ray energies.

The Laue lens circumvents this problem. It is a 1-D focusing element made by thin-film aperiodic growth, in which the periods coincide with Fresnel zones. A small section of the thin film is removed by focused ion beam (FIB) etching and used in transmission. One challenge in this approach is to have a large aperture. Traditional multilayers have typically <100 periods, whereas Laue lenses have to have tens of thousands to have sufficient aperture. This means that thin-film thickness and stress must be controlled to high precision.

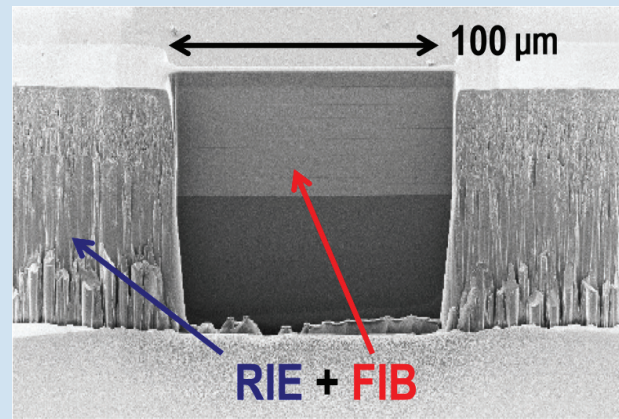
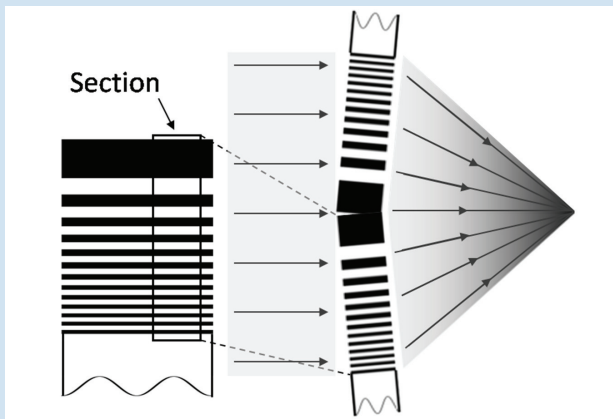

A second challenge is placement of the layers precisely in the position of the Fresnel zones. Sophisticated metrology based on SEM is used to calibrate the position of each layer. The converging layer structure (left) is measured using SEM so that the placement accuracy of the zones can be quantified (right) [12].

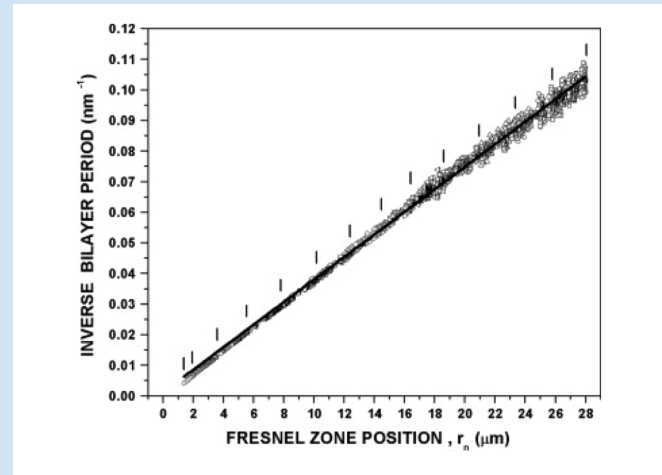
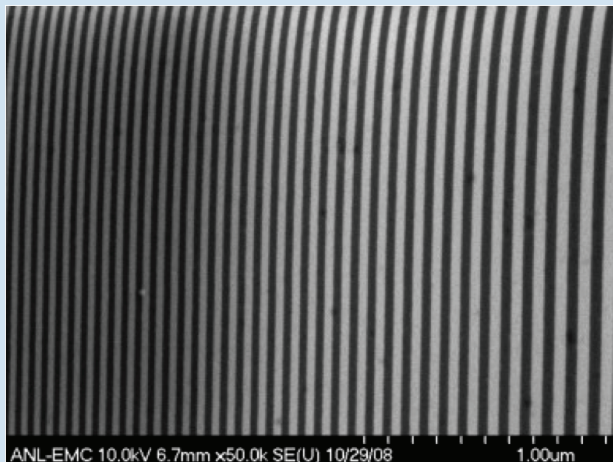

## Multilayer Laue Lenses Can Be Used for High-resolution Hard X-ray Microscopes

Multilayer Laue lenses can be used in a crossed configuration to form a pointlike focus. An image is then formed by scanning the sample in the fixed focus.

The great advantage of the MLL is that it can focus high-energy X-rays. This is useful in a wide range of cases, such as the examination of thick objects like fuel cells under true operational conditions. As multilayer films can be made down to a period of around 1 nm, in principle nm resolution should be achievable, even for high energies. This will bring a revolutionary new capability to synchrotron radiation research.

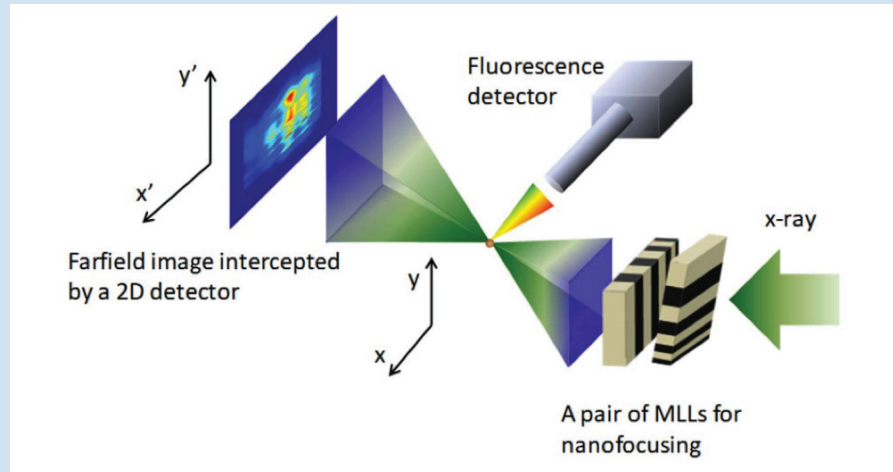

In preliminary work, the Laue microscope has been used to look at the structure of electrode materials used within a solid-oxide fuel cell (SOFC). In this case, the SOFC anode consisted of a nickel and yttria-stabilized zirconia (YSZ) cermet and the Ni distribution was mapped through K-edge fluorescence. Differential phase contrast information was recovered from the far field image. [11]

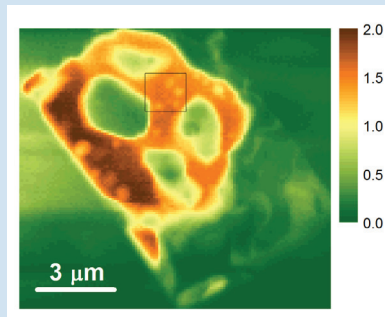

## Proton exchange membrane fuel cell

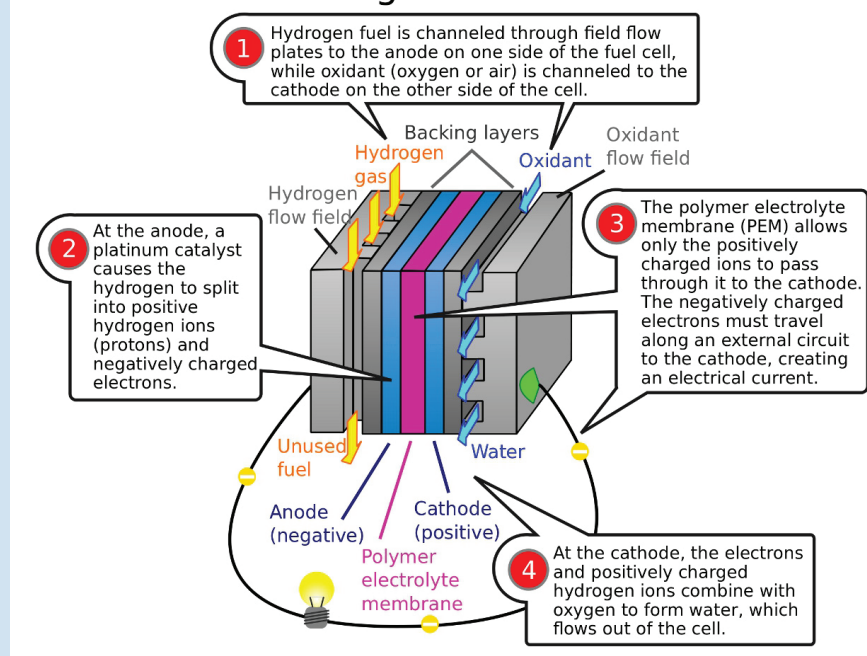

## Impact

Thin films are a fundamental building block for many X-ray optical elements. While much knowledge has been amassed from the traditional optics industry, thin films for X-ray optics involves a completely different set of materials processes and challenges. If we can make progress in a few key areas, we can expect a large impact on our ability to use the extreme brightness produced by today's sources.

We can highlight two areas in which we can expect large impact:

- **Resonant X-ray inelastic scattering (RIXS).** This is a new and powerful tool for elucidating the nature of the low-energy excitations that drive the behavior of many quantum materials that gain their properties through electron correlation. Such materials include high-temperature superconductors and topological insulators. Because many of the absorption edges that probe dipole core-to-valence transitions of the relevant elements (e.g., oxygen, 3d-transition metals, rare earths) are in the soft X-ray region, monochromators and spectrographs using gratings have to be used. The state of the art today is a total resolution of around 150 meV at these soft X-ray energies, whereas the energy scale of the soft excitations that we need to probe — for example phonon and magnons — are in the range of a few to a few tens of meV. In order to bridge this resolution gap, we cannot simply increase line density or the scale of the optical systems due to efficiency and practical considerations. One promising solution is to use dense multilayer gratings in high spectral order [3]. In principle, these can achieve extreme spectral resolving power and essentially follow the methodologies used for high-spectral-resolution optical spectroscopy. However, although essentially atomically perfect substrates can now be made, the structured grating surface causes the multilayer coating not to be conformal, resulting in a rounding and distortion of the coating. The consequence is significant loss in efficiency, and a limit to the high order that can be used. If these problems can be solved, we can expect that RIXS will be taken to a new level and will have a major impact in the study of complex quantum materials.
- **Hard X-ray microscopy.** The resolution of ZP-based hard X-ray microscopes today is limited by the aspect ratio that can be produced, i.e., the ratio between thickness and outer zone width. This problem gets much worse as X-ray energy increases, so not only are resolution and efficiency limited, but the maximum operating photon energy is limited to relatively low energies. However, there is a pressing need to examine the nanostructure of thick materials, usually while in operational conditions or in a controlled sample environment. One broad example is the examination of energy-storage devices under operational conditions. This requires high X-ray energy to allow penetration through the structure of the whole device, but at the same time requires resolution much less than 10 nm. One of the best routes to this is based on X-ray microscopy using crossed MLLs. These do not suffer from the aspect-ratio issues of ZPs, and in principle can achieve simultaneously high efficiency and very high (nm) resolution. Although very encouraging results have been obtained, the resolution so far has been quite modest, around 25 nm. Research is needed to develop these potentially revolutionary focusing elements to their ultimate extent. If developed to their theoretical potential, we will have a new and powerful tool to study thick functional materials and systems, with many potential applications in energy sciences [11].

## References

1. R. Conley et al., *Multilayer growth in the APS rotary deposition system*, SPIE 6705, 670505, 1-5, 2007.
2. E. Spiller, *Reflective multilayer coatings for the far UV region*, Appl. Opt. 15, 2333-2338, 1976.
3. D. Voronov et al., *Ultra-high efficiency multilayer blazed gratings through deposition kinetic control*, Opt. Lett, 37(10), 1628-1630, 2012.
4. R. Soufli et al., *Lifetime and damage threshold properties of reflective X-ray coatings for the LCLS free-electron laser*, Proc. SPIE 8077, 807702, 2011.
5. S. P. Hau-Riege et al., *Interaction of short X-ray pulses with low Z X-ray optics materials at the LCLS free-electron laser*, Optics Express 18(23), 23933-23938, 2010.
6. D. Windt, *IMD software for modeling the optical properties of multilayer films*, Computers in Physics 12(4), 360-370, 1994.
7. H. Huang, G. H. Gilmer, and T. Diaz de la Rubia, *An atomistic simulator for thin film deposition in three dimensions*, J. Appl. Phys. 84(7), 3636-3649, 1998.
8. X. W. Zhou and H. N. G. Wadley, *Low energy ion assisted control of interfacial structure: Ion fluence effects*, J. Appl. Phys. 88, 5737-5743, 2000.
9. R. Soufli et al., *Spontaneously intermixed Al-Mg barriers enable corrosion-resistant Mg/SiC multilayer coatings*, App. Phys. Lett. 101, 043111, 2012.
10. H.C. Kang et al., *Nanometer linear focusing of hard X-rays by a multilayer Laue lens*, Phys. Rev. Lett. 96, 127401, 2006.
11. H. Yan et al., *Quantitative X-ray phase imaging at the nanoscale by multilayer Laue lenses*, Nature Scientific Reports 3, 1307, 2013.
12. R. Jahedi et al., *Metrology of multilayer Laue lens structures by means of scanning electron microscope imaging*, Nucl. Instrum. Meth. A 616(2-3), 89-92, 2010.

# Adaptive X-ray Optics

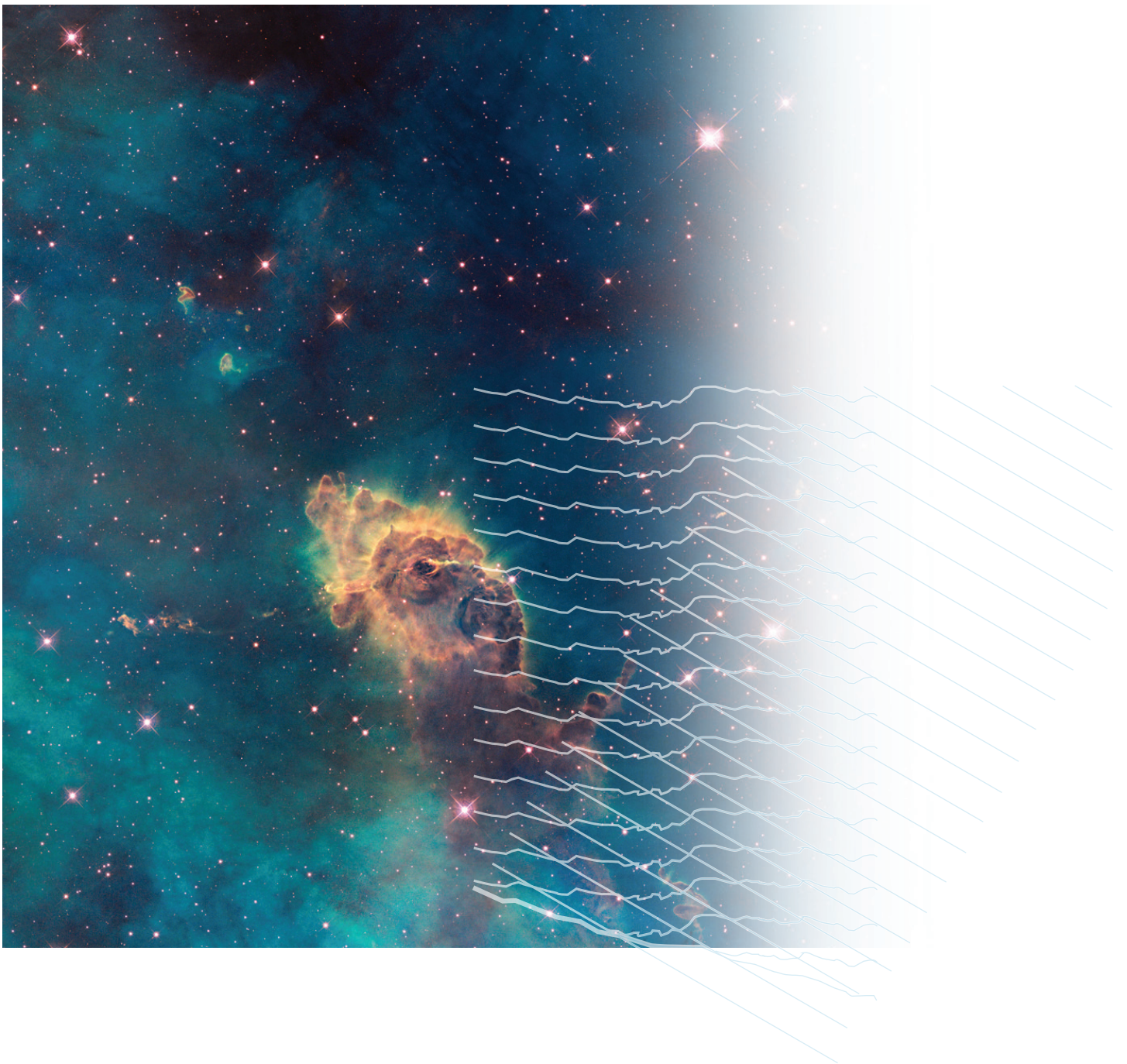

## Summary

Adaptive optics (AO) is a technique whereby a deformable optics is adjusted in real time to correct for aberrations in an optical system. AO is well-established in vision, science, and astronomy; in the latter field, it has opened up new frontiers such as the direct imaging of planets around other stars.

AO, when applied to X-ray light sources, helps scientists utilize the ultimate capabilities modern sources can provide in terms of brightness, wavefront quality, and coherence. AO provides a relatively inexpensive way to overcome fundamental limits of present X-ray optics, such as the correction of mirror-polishing errors, on-demand beam shaping customized to each science target, and real-time correction of optics under dynamic environmental conditions.

### Working Group Chairs:

N. Kelez (SLAC)

L. Poyneer (LLNL)

### List of contributors in alphabetical order:

L. Assoufid (ANL)

Y.-D. Chuang (LBNL)

O. Chubar (BNL)

S. Hau-Riege (LLNL)

M. Idir (BNL)

J. Krzywinski (SLAC)

B. Macintosh (LLNL)

S. Matsuyama (Osaka  
University, Japan)

R. Signorato (Bruker)

C. Svetina (Synchrotrone  
Trieste, Italy)

V. Yashchuk (LBNL)

Many areas of science can benefit from AO. Two examples are ultrafast studies and coherent diffraction imaging. For ultrafast materials science, customized beam shapes provide uniform excitation of the sample by the X-ray beam, allowing much more accurate probing of phase changes and material states. For coherent diffraction imaging, the improved coherence and wavefront quality improves the resolution of recovered images.

Our conclusions are very much in alignment with those from the *X-ray Mirrors, Simulation and Modeling*, and *Optical and X-ray Metrology* working groups. In addition to the application-specific elements of those areas, we recommend the following R&D and broader development goals:

### RECOMMENDATIONS

- 1. An R&D program should be developed in support and actuation technologies for deformable mirrors.** Support mechanisms and actuation represent the broadest, most challenging, and therefore the highest-priority elements of an R&D necessary to realize true AO for X-ray applications.
- 2. Algorithms and control software should be developed.** A robust, user-friendly software is needed that is adaptable to a range of higher-level control schemes (LabVIEW, EPICS, etc.) and applications.
- 3. Ready access is needed to testing facilities for long-term technology development.** This includes, for example, access to beamline testing facilities so that systems can be tested and developed before deployment as robust systems in beamlines.
- 4. Collaboration should be enhanced.** Collaboration between research labs and industry for all aspects of development and realization of systems is needed, as well as formation of collaborative design teams of scientists and engineers to deliver fully integrated and robust AO systems.



## Scope

The evolution of X-ray sources and experimental techniques continues to drive improvements in X-ray optics. X-ray free electron lasers (XFELs) and future storage rings will deliver extremely intense and fully transverse coherent pulses that will enable new science. As a result, the performance requirements for the optics necessary to support these capabilities will push the state of the art for mirror figure and shape (see the *X-ray Mirrors* chapter), particularly in the case of large mirror systems (>0.5-m length).

A potential solution for meeting these demanding requirements is to extend the developments that have been made in the astronomy and vision science fields to the field of X-ray optics. In the past two decades, AO systems in astronomy have advanced from conceptual demonstrations to scientific mainstays, opening entirely new scientific frontiers [1,2] (see *Adaptive Optics in Astronomy*, next page). This technology has also worked successfully in other areas of science, including vision science for imaging the human retina in vivo [3], high-power laser systems, communication, and visible light microscopy [4].

### HOW DOES IT WORK?

All optical systems suffer from distortions, which can be either external (such as those caused by the refraction of light through the Earth's turbulent atmosphere in astronomy) or internal (such as optical-system polishing errors). These distortions significantly degrade the performance of the optical system from the optimal, resulting in reduced resolution and contrast. Adaptive optics for science applications work by correcting these distortions before the light is detected. The correction is physically implemented through technology called a deformable mirror (DM). The DM is a reflective optical element with a flexible surface that is deformed by actuators. DMs can have from a few to a few thousand actuators; in general, the more actuators, the better distortion correction.

The surface shape of the DM is commanded by the adaptive optics control system to meet a desired scientific output. In the most common case, this is done through use of a wavefront sensor (WFS). Some of the light is split away from the sample and directed to the sensor, which measures the deviation of the phase of the optical field from a (perfect) reference phase. This measured phase error is then compensated for by the deformable mirror through adjustment of the mirror's surface. In more specialized cases, the science output itself (e.g., an image) is analyzed and used similarly to the WFS to determine the best mirror shape.

The rate at which the AO system measures and corrects the light is set primarily by the temporal evolution of the distortion. Due to sensor readout time and computational delay, a typical AO system runs 10 times faster than the desired correction frequency. Many astronomical systems run at 1 kHz to keep up with the windblown turbulent atmosphere. However, if the distortions vary gradually with time, the system can run quite slowly. These slow systems are usually termed "active optics"; one example is the very slow adjustment of the segments or surface of a large (>8 m) telescope's primary mirror.

### WHY DO WE WANT IT?

The use of AO in the X-ray regime is strongly motivated by two key factors.

First, AO lets us overcome the performance limit set by current technologies. Despite having the best mirrors available, beam quality at low-emittance sources is often compromised. Polishing errors are dominated by low spatial frequencies (a few to tens of millimeters), which means that most of the error could be corrected with a deformable mirror.

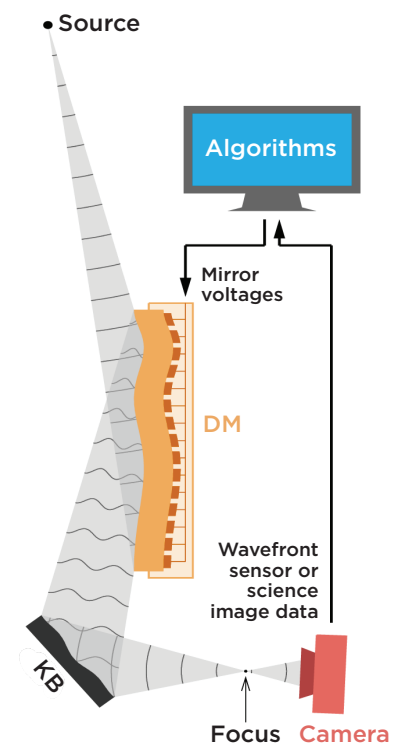

The two key steps and technologies for active and adaptive optics are measuring the beam quality with a wavefront sensor, and then correcting the beam with a deformable mirror. The sensor is normally used in closed loop, which means it sees the compensated beam after the DM. The residual phase is fed back through algorithms to control the shape of the DM.

Second, AO will allow us to do things static optics cannot. An excellent example of this is on-demand beam profile shaping. In laser applications, AO is employed to provide a specified beam profile, or spatial distribution of intensity. The capability for directly shaping the X-ray beam intensity would be very powerful scientifically when the X-rays are used as a pump. For ultrafast materials science, an X-ray beam that has a Gaussian profile will heat (or ionize) the sample non-uniformly. An AO system could be designed to produce a beam that has a more uniform (even flat-top) profile, resulting in more even heating or excitation of the sample. This condition greatly simplifies intensity-based diffraction and scattering techniques that must now be normalized for beam profile.

## Issues

### WHAT IS DONE TODAY?

Many X-ray beamlines already use some sort of adjustable optics. Three primary drivers have led to the proliferation of these systems: (1) mirror manufacturing challenges, (2) beam manipulation (e.g., multiple foci size or location requirements), and (3) aberration correction. Although adjustable mirrors are in regular use in active optics systems, they are primarily implemented as tunable systems for discrete modifications, often based on ex situ characterizations.

Regarding mirror manufacturability, significant advances in directly figured X-ray mirrors have yielded extremely high-quality optics. However, measurement and testing of shaped mirrors during the fabrication process present many challenges that impact cost and schedule. In contrast, flat optics can be more easily fabricated and measured by conventional metrology methods and can be mechanically deformed to final figure by appropriate actuators.

The requirement that beamlines have variable beam parameters has also benefited from active optics. Techniques that require changes in focal spot size or multipurpose beamlines with separate end stations requiring multiple focal lengths can be accommodated by modifications to the figure of the mirror. And while fixed-figured mirrors can be used in some of these applications, the resulting aberrations and changes in beam angle and position are often undesirable.

Finally, advances in X-ray sources have resulted in techniques that utilize the full coherence, phase, and amplitude of the beam. Preserving these characteristics through the transmission of complex optical systems has led to the development of deformable correction optics that compensate for aberrations induced by intrinsic optics-manufacturing errors, environmental effects, and changes in beam characteristics such as heat load or polarization.

Although early attempts to implement both open- and closed-loop adaptive systems based on in situ measurements with typically ex situ tools (e.g., interferometry) date back to the early 1990s, a real-time closed-loop adaptive system at X-ray wavelengths has not yet been robustly demonstrated. However, significant progress has been made [5] in technology and we address the present state of technology and key issues in the next section.

## Adaptive Optics in Astronomy

The improved resolution and contrast of adaptive optics (AO) have enabled astronomers to see what had previously been obscured. AO is now used by all major observatories and is being integrated directly into the telescope itself in current and future observatories.

**Top:** The Galactic Center without adaptive optics. (*Keck Observatory*)

**Bottom:** The Galactic Center and central black hole (labeled Sgr A\*) with adaptive optics. (*Keck Observatory and the UCLA Galactic Center Group*)

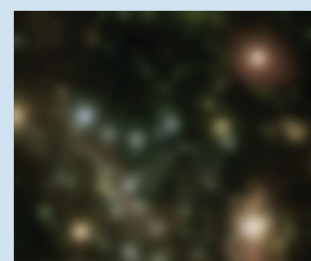

The lower figure is an infrared image of the four planets of the HR 8799 planetary system. (*NRC-HIA, Christian Marois, and the W.M. Keck Observatory*) [2]

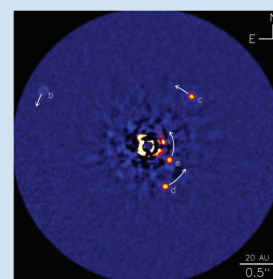

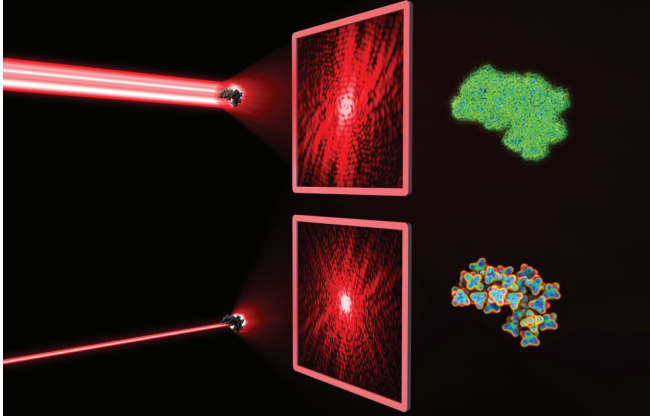

An artist's conception of CDI illustrates the difference in reconstruction quality that could be provided by adaptive optics. At the top, an aberrated, partially coherent beam hits the target object, producing a diffraction pattern on the detector. The beam's aberrations limit the accuracy of the recovered image. At the bottom, adaptive optics provides a coherent, excellent wavefront-quality beam to hit the target, which produces a different diffraction pattern. The object is recovered with improved resolution. *(Kwei-Yu Chu)*

location relative to the source and sample, the impact ranges from variations in intensity to aberrations in the focal spot and variations in phase and amplitude.

An additional complication for CDI is preserving the detailed properties of the coherence function of the beam. This function contains information about the point-to-point correlation function of the field that is required to accomplish the wave propagation that underlies the CDI method. The coherence function changes as it propagates through the optics and is adversely affected by the deviations from ideal figure and height requirements.

In all cases, the rectification of mirror errors would assist the execution of CDI-style experiments at both storage rings and fourth-generation FEL sources. Control of these parameters could, for example, be used to smooth the wavefronts and coherence function over the length scales appropriate for each sample, simplifying the goal of high-resolution lensless imaging.

### ULTRAFAST MATERIALS SCIENCE

In ultrafast materials science, the bright X-ray beam can be used to heat or ionize the sample and induce structural changes in the sample. XFELs such as the Linac Coherent Light Source (LCLS) are sufficiently intense to convert materials into plasmas such as warm-dense and hot-dense matter [6]. For sufficiently thin samples, this transformation is uniform through the thickness (with  $z$ ) of the material. An X-ray beam with a Gaussian intensity profile will result in non-uniform excitation of the sample. In contrast, if an AO system could shape the beam into a more uniform flat-top intensity profile, the excitation across the sample ( $r$ -direction) will be much more uniform. This uniform

### COHERENT IMAGING APPLICATIONS

Coherent diffraction imaging (CDI) is a "lensless" microscopy technique that replaces an image-forming optics with a calculation, which removes the resolution limit normally imposed by the optics. This technique and its extension to single-particle imaging have been met with high levels of interest and have become one of the primary science drivers for the construction of XFELs. CDI is a kind of full-field microscopy, where a large field of view is recovered from each two-dimensional measurement. Such experiments can be extended to three-dimensional imaging and can yield images with a resolution that is limited, in principle, by the highest angle at which elastically scattered X-rays can be measured, and their wavelength. Because of the intermixing of the imperfect illuminating wave with the complex-valued index of refraction of the sample, the interpretation of such experiments is intrinsically limited to the understanding of the properties of the incoming X-ray beam.

Surface height variations, at both mid- and high-spatial frequencies, as well as low-frequency figure errors, are the predominant factors resulting in non-ideal illumination conditions. Depending on the optics

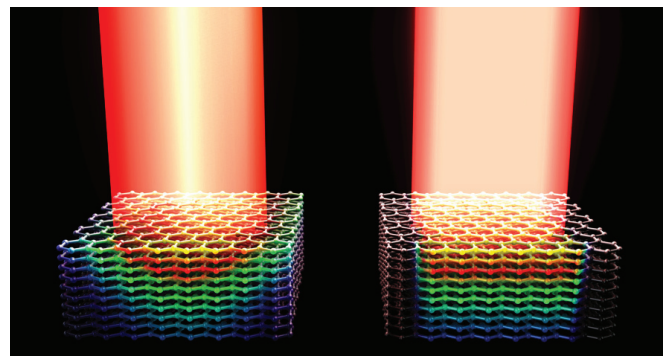

An artist's conception of an ultrafast materials science experiment shows the improved uniformity of material heating and phase change, which will lead to higher-precision characterization of material states. A Gaussian-shaped beam (left) has variable intensity with radial location, resulting in non-uniform heating of the material (shown in colors on the lattice). Adaptive optics could provide a custom beam-shape, in this case a "flat-top" profile (right). This beam has uniform intensity with radial location, producing uniform heating across the area of beam incidence on the sample. *(Kwei-Yu Chu)*

pumping of the sample in both z and r will enable high-precision characterization of plasma states.

Five major areas must be addressed in order to make AO for X-rays a working reality: deformable mirrors, wavefront sensing, algorithms, simulations, and testing.

### DEFORMABLE MIRRORS

A variety of DMs, ranging in size and complexity, are currently in service around the world. The most common implementation of DM is a simple two-component (three-component with side shaping), bendable mirror that can correct up to third-order polynomial shapes. However, correction of the higher-order, aspheric wavefront shapes typically associated with manufacturing errors requires many regularly spaced actuators. Recently, systems have been developed on optics >1 m in length and controlled with up to 36 independent actuators.

One DM technology actively under development is the use of surface-parallel piezoelectric actuators under a super-polished silicon substrate. However, several challenges need to be addressed that are related to the use of the DM in a specific beamline:

1. Robust designs must be developed for face-sheet thickness, actuator composition, and spacing such that the DM has enough stroke and spatial frequency range to provide necessary corrections.
2. Actuators have varying behavior in time, which greatly complicates their ability to maintain a certain figure at the angstrom level. Bad repeatability (due to hysteresis in the piezo-actuators) and slow deformation drift from piezo creep have been observed. Radiation damage to the actuators may be an issue as well. Heat loads on the DM will further complicate matters, as material properties will change with temperature. Mounts and support structures must also be stable at the same level as the DM. As noted earlier, AO is an attractive approach for very long optics with unstable mounts or mounting-induced deformations.
3. Attachment of the actuator to the mirror (sometimes called print-through or junction error) is a concern, especially with thin substrates.
4. There are manufacturing concerns with power supply and drive electronics.
5. Actuators may have significant challenges in terms of vacuum performance. This is a particular concern for ultra-high-vacuum (UHV) systems in soft X-ray applications where carbon deposition from outgassing of the DM components can drastically affect mirror performance.

### WAVEFRONT SENSING

There are several different options for wavefront sensing at X-ray wavelengths. Most of these approaches function as gradient or slope

### How a Wavefront Sensor Measures the Phase

The figure at right shows the principle of the Hartmann wavefront sensor. It uses a mask to produce a grid of spots on a detector. The top figure shows the arrangement of spots when from an undistorted wavefront while the bottom shows the displacement of the spots from the regular array due to the distorted wavefront. The displacements are proportional to the wavefront slopes. The distorted wavefront can be reconstructed from the measured slopes.

(A Henke, LLNL)

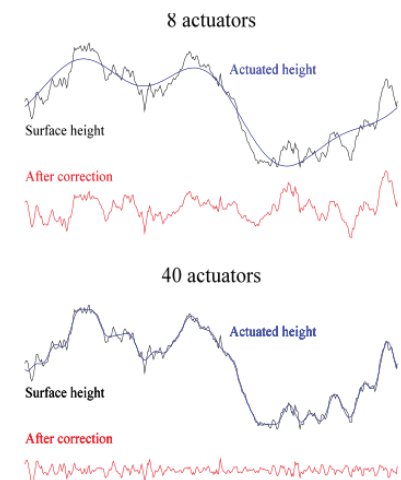
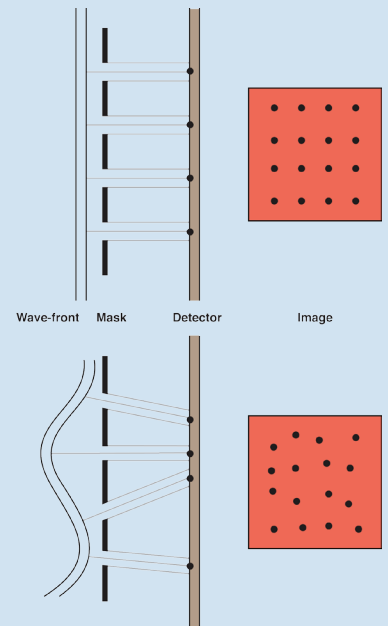

A DM can compensate low-frequency polishing errors. Having more actuators closer together allows a wider range of errors to be corrected and produces better wavefront quality.

sensors. The sensor uses amplitude or phase gratings to produce either a fringe pattern or a grid of spots. The local displacement of a spot or fringe is a function of the spatial gradient of the wavefront phase at the corresponding location in the beam.

The most widely demonstrated sensor is the Hartmann sensor. It employs an amplitude mask with an array of holes to produce on a detector an image of a grid of spots. Another sensor that has more recently been developed and demonstrated is the grating (or Talbot) interferometer. In the one-dimensional case, a phase grating is used to interfere shifted copies of the wavefront, producing a fringe pattern. In the two-dimensional case, a phase checkerboard, usually accompanied by a similar checkerboard amplitude grating, is used to produce a grid of spots. Hartmann sensors and Talbot interferometry have been demonstrated in the extreme ultraviolet and soft X-ray regimes, and recently the grating interferometer at hard X-ray wavelengths has been demonstrated at the Advanced Photon Source, the LCLS, SPring-8 (Japan), and other sources.

Additional wavefront sensor options that have been demonstrated are direct science-image based sensing, such as the knife-edge test and phase diversity. These generally require many measurements and may not be suitable for real-time use in a beamline.

These types of wavefront sensors, viewed from the perspective of metrology, are discussed thoroughly in the *Optical and X-ray Metrology* chapter. From the perspective of use in an AO system, several fundamental issues must be addressed:

1. Theoretical understanding of each sensor's dynamic range, inherent bias, susceptibility to aliasing, and noise propagation.
2. Understanding of design limitations (e.g., minimum hole spacing or grating period) for a wide range of wavelengths given current detector technology (e.g., pixel size).
3. Determination of robust calibration schemes to ensure rapid acquisition of absolute (not relative) phase measurements at the sub-nm (or sub-angstrom) level.
4. Implementation of WFS as a non-invasive and simple hardware solution that can provide real-time control of a DM (moving from off-line "active optics" to science-time "adaptive optics"). Real-time at-wavelength WFS is one way to compensate for the repeatability and drift issues known to exist in the DM (see above).
5. Simultaneous use of the light for sensing and science is typical in astronomy. For X-rays, this may solve the challenge of non-invasive sensing. This could be implemented with refractive lenses. They are in-line, and hence easy to align. However, the split angle is low and the two beams may not be separated enough to effectively put in gratings, sensors, etc., without blocking the primary beam. For soft X-rays, a few percent of the beam could be picked off via a grazing incidence, low-efficiency grating as demonstrated at the Sincrotrone Trieste. Other possibilities for hard X-rays might be very thin diamond or silicon crystals.

## ALGORITHMS

Several properties of X-ray optical systems make the conversion from WFS measurement to best DM surface profile nontrivial. In the general astronomical case, the phase errors on the wavefront in the pupil plane dominate over amplitude errors and phase errors that are out-of-plane. The science data is taken in the image plane, which is a Fourier transform of the pupil. This means that a WFS can easily be set up to measure the wavefront phase in the pupil.

In the X-ray regime, many of these assumptions may not hold. First, the system may not have a pupil-image plane pair that allows easy optimization. Second, phase errors will occur on all optics, which may be widely spaced in the beamline. Third, due to the beam sizes and wavelengths, phase errors will turn into amplitude errors (and vice versa) as the beam propagates, a phenomenon termed the Talbot effect. This may fundamentally limit the ability of a single DM to correct phase errors on the surfaces of other optics. In summary, the algorithm that determines the best optimal commands from the WFS to optimize the shape of the DM for a specific science criterion may be nonlinear, and will depend on system design.

Algorithms that control amplitude and phase are used in high-contrast astronomical AO test beds, so there is an existing framework to build on. However, the best algorithm is an open question, and may well turn out to be system-specific, based on the beamline optics and experimental techniques. Robust simulation tools (see below) will greatly aid in the development of such tailored algorithms.

### **SIMULATIONS**

Work in all topics above will be greatly aided by a robust and versatile simulation capability (see *Simulation and Modeling* chapter). Of particular interest for AO are simulations that are computationally feasible enough to allow many different designs to be simulated and studied. Proper treatment of highly curved optics (e.g., each optic in a Kirkpatrick-Baez pair) is essential. These simulations will tie together specific beamlines, deformable mirrors, wavefront sensors, algorithms, and science goals to provide an end-to-end assessment of system performance.

An important question that could be addressed through detailed simulation is whether a single flat DM could sufficiently correct all the other beamline optics (some of which may not be flat). If not, each optic may need to be made deformable, and used to correct itself.

### **TESTING FACILITIES**

Because of the unique nature of X-ray light sources, in many cases the only place to test new hardware is at the beamline itself. This is particularly true for at-wavelength diagnostics and in situ metrology. However, beamlines are in round-the-clock use. We strongly encourage the development of dedicated end stations at synchrotrons for the development and testing of new hardware, or at the least the allocation of beam time specifically for technology testing and system optimization.

## **R&D Directions**

Of the five issues above (deformable mirrors, wavefront sensing, algorithms, simulations, and testing facilities), two are specific applications of other topics: simulations and sensing/in situ metrology. R&D directions for those topics are addressed in those respective chapters. We then have three specific areas that require R&D for adaptive X-ray optics: (1) support mechanism and actuation for deformable mirrors, (2) algorithms and controls, and (3) dedicated testing facilities.

Support mechanism and actuation for large DMs represent the broadest, most challenging, and therefore the highest-priority elements of the R&D necessary to realize true AO for X-ray applications. Support and actuation systems must have nanometer-displacement capability with subnanometer stability and precision. It is unlikely that a single technology can be implemented as a one-size-fits-all solution. Instead, development must follow a multipronged approach that identifies key enabling technologies from a range of sources. These enabling technologies are then fully characterized and optimized to address the broad range of applications such as high heat load, internally cooled, cryogenic, highly aspheric large curvature, ultra-high vacuum, or any combination of these.

Algorithms and controls encompasses the entire process from reading out detector pixels on the WFS to commanding voltages to the DM. Of particular need of development are algorithms that accurately and precisely estimate the phase and amplitude of the beam. This information then must be used to provide the best correction possible for the specific science goal, using only the surface height of the DM(s). A long-term goal would be development of comprehensive control methods that predict the temporal evolution of the system errors, as is currently nascent in astronomical AO. Development of these algorithms will be greatly aided by physically accurate simulations, perhaps even through a forward-model approach.

Dedicated testing facilities (either an end station at a synchrotron or a parasitic R&D beamline at an XFEL) that are available for long-term technology development and system testing must be established. System build, integration, and test is an intensive process that will take many months to even a few years, depending on system size and complexity. The most progress will be made toward advancing technology and improving our understanding if dedicated R&D beamlines are available.

### Effect of Coherence on Coherent Diffraction Imaging Reconstructions

This is the reconstructed isosurface of a nanocrystal under different beam coherence conditions. The top was imaged under high coherence conditions, assuming full coherence in the analysis. At the bottom is of the same nanocrystal imaged under low coherence conditions but assuming full coherence in the analysis. As a result, unphysical density artifacts arise, in this case manifesting themselves in the lower part of the crystal being missing. Such artifacts can be removed if the coherence properties of the beam are known, but minimizing the wavefront distortion through adaptive optics can alleviate some of difficulties in the analysis. The black scale bar on the left is 100 nm. (From Clark et al. [7])

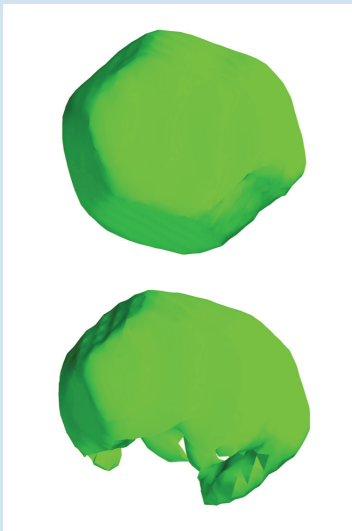

In addition to these three specific technology areas, we add a fourth recommendation for the process of this R&D: We need to move beyond focus on individual elements (e.g., specific DM, specific WFS) and begin testing AO systems in a collaborative fashion. We need to progress toward the long-term goal of at-wavelength, real-time, non-invasive AO. These are complicated systems and there is no one “AO system” that will work for all applications. As such, AXO developers must work closely with X-ray scientists, mechanical and controls engineers, and optics vendors to design specific systems. No one laboratory or company has most, let alone all, of the necessary technologies, R&D programs, and facilities. Many labs and industries must work together in a lasting collaboration to effectively follow developments through to user-friendly implementations.

## Impact

Because X-ray mirrors are so widely used at light sources, any advances in mirror performance can have a significant impact across a large number of research programs. For this reason alone, exploring the use of AO is a worthy pursuit. As described in more detail in the *X-ray Mirrors* chapter of this report, high-quality mirrors are critical for a wide variety of uses, including focusing for nanodiffraction and nanoprobes.

AO techniques have made a significant impact on visible-light astronomy, and when applied to X-ray light sources will help scientists utilize the ultimate capabilities modern sources can provide in terms of brightness, wavefront quality, and coherence. AO provides a relatively inexpensive way to overcome fundamental limits of present X-ray optics, such as the correction of mirror-polishing errors, on-demand beam shaping customized to each science target, and real-time correction of optics under dynamic environmental conditions.

The correction of mirror errors can impact many areas of science, but the largest impact of adaptive X-ray optics may come in perhaps the areas that exploit the coherence of the beams, such as coherent diffraction imaging (CDI). The CDI technique allows the imaging of a wide variety of samples in two and three dimensions. CDI requires knowledge of the coherence function of the beam. As explained in *Effect of Coherence on Coherent Diffraction Imaging Reconstructions* at left, uncertainty in the knowledge of the incoming illumination can severely affect the quality of the reconstructed images and limit the interpretation of such experiments. Although in some cases the effects of a partially coherent beam can be dealt with in the analysis, AO should improve both wavefront quality and coherence, hence improving the veracity of recovered images. Given the drive for fully coherent sources, whether they be XFELs or ultimate storage rings, the demand for the highest-quality X-ray mirrors will only increase.

## References

1. A.M. Ghez et al., *Measuring distance and properties of the Milky Way's central supermassive black hole with stellar orbits,* Astrophysical Journal 689, 1044-1062, 2008.
2. C. Marois et al., *Images of a fourth planet orbiting hr 8799,* Nature 468, 1080-1083, 2010.
3. A. Roorda and D.R. Williams, *The arrangement of the three cone classes in the living human eye,* Nature 397, 520-522, 1999.
4. O. Azucena et al., *Adaptive optics wide-field microscopy using direct wavefront sensing,* Opt. Lett. 36, 825-827, 2011.
5. H. Mimura et al., *Breaking the 10 nm barrier in hard-X-ray focusing,* Nature Physics 6, 122-125, 2010.
6. S. P. Hau-Riege et al., *Ultrafast transitions from solid to liquid and plasma states of graphite induced by X-ray free-electron laser pulses,* Phys. Rev. Lett. 108, 217402, 2012.
7. J.N. Clark et al., *High-resolution three-dimensional partially coherent diffraction imaging,* Nature Communications 3:993, 2012.



# Refractive Optics

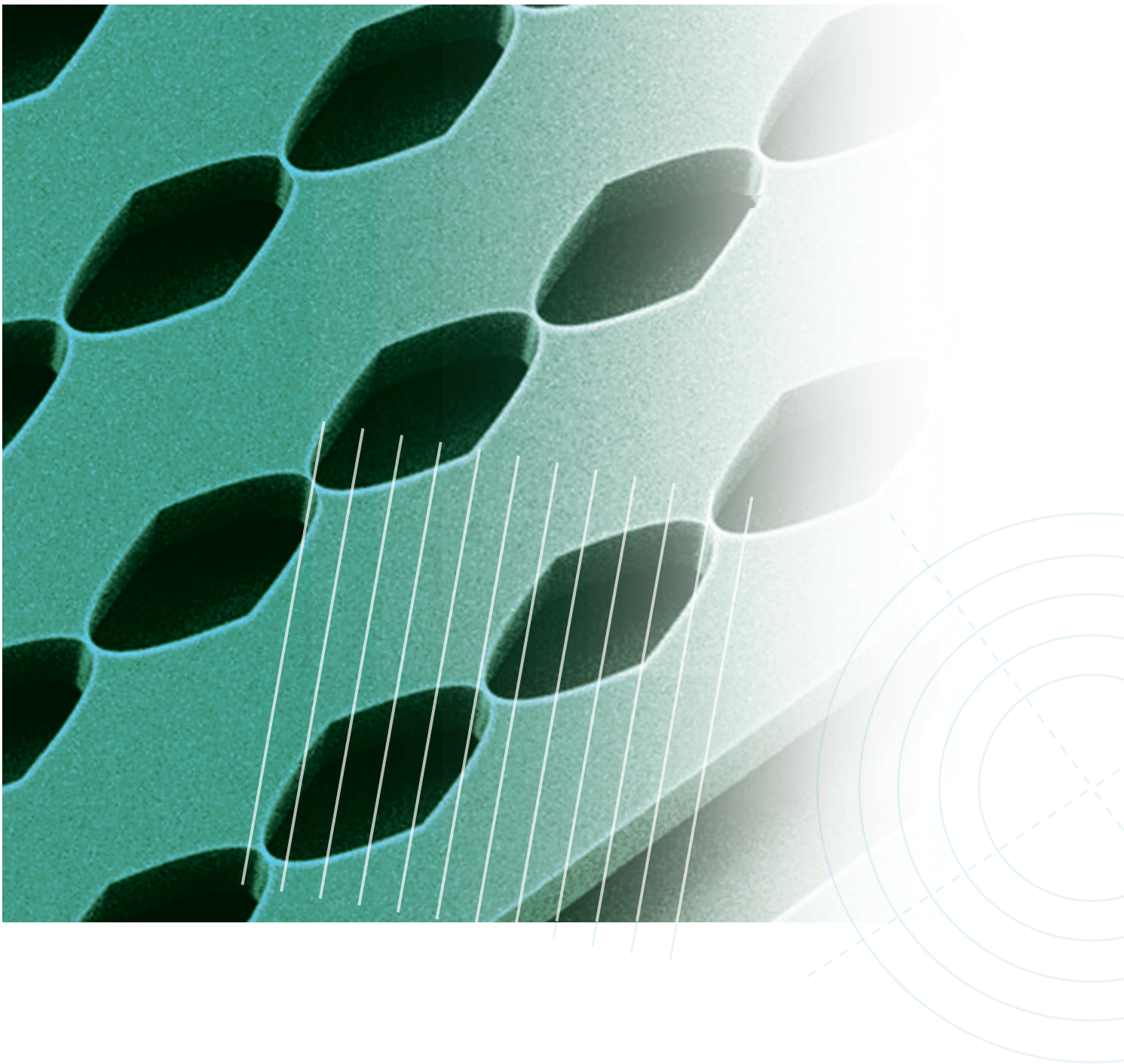

## Summary

Refractive optics use the index of refraction of X-rays in lens materials and the shape of the lens to manipulate the X-ray beam. Combined with the emerging ability to create precisely shaped lenses over a wide range of length scales, refractive optics have led to the creation of a variety of novel focusing and beam-shaping optics. Their strengths as compact, in-line, stable, easily aligned, coherence-preserving optics for modest (microbeam) focusing have been more widely recognized in Europe where, for example, over 50% of the beamlines at the European Synchrotron Radiation Facility (ESRF) in Grenoble, France, employ them. In the United States, however, their usage is considerably lower.

### Working Group Chairs:

K. Evans-Lutterodt (BNL)  
A. Sandy (ANL)

### List of contributors in alphabetical order:

L. Allianelli (Diamond Light Source)  
A. Baron (Spring-8)  
W. Jark (Elletra)  
A. Khounsary (ANL)  
A. Last (Karlsruhe Institute of Technology)  
B. Lengeler (RWTH Aachen University)  
S. Shastri (ANL)  
J. Tabeling (Delaware Diamond Knives)

The most widely used refractive optic is the compound refractive lens (CRL). CRLs are based on mature technologies and are now commercially available. For the more conventional X-ray energy range (2–30 keV), the lenses are usually made from polycrystalline beryllium foil, while for higher-energy applications they are made from aluminum or nickel. Based on their strengths listed above, we believe adoption of CRLs should be encouraged in the United States. This might be done by creating loaner units at synchrotron sources so that beamline staff become more comfortable with their use. Such a program would enable existing and new beamlines in the United States to realize the same benefits of these simple but powerful optics that Europeans already enjoy.

Refractive optics are uniquely useful at high X-ray energies where other types of optics do not perform as well. An example of such an underserved application is microfocusing to beam sizes of order 1  $\mu\text{m}$  at high photon energies ( $E > 30$  keV). At high X-ray energies, the efficiency of zone plates is very low while the apertures of multilayer Laue lenses (MLLs) are too small. In addition, at high energy, mirrors that intercept a reasonable fraction of the beam become large, unwieldy, and expensive.

Refractive optics will undoubtedly become more widely used at U.S. facilities as significant improvements are achieved in materials such as diamond and beryllium, and further refinement in the shaping of these materials is made. Specifically, we believe that advances in the three recommendations listed below would result in improvements in high-energy applications and coherence-sensitive applications such as coherent X-ray diffraction imaging and X-ray photon correlation spectroscopy.

### RECOMMENDATIONS

1. **Develop the full potential of silicon refractive optics by improving the quality of deep silicon etching, resulting in larger optical apertures, better transmission, and reduced aberrations.** Planar silicon technology, derived from advances in the fabrication tools for the micro-electronics industry, has led to the creation of many novel optics that provide unprecedented control of the phase profile of an X-ray beam. Planar silicon technology has three features that provide ample room for growth and improvement. First, the cycle for design, fabrication, and testing can be very quick, on the order of days, as opposed to the months typical for other optics. Second, the

fabrication tools are shared tools, widely available in industry and at many U.S. Department of Energy (DOE) nanocenters. This means lower costs and the potential for widespread use. Third, in many instances, silicon refractive optics have been used primarily at lower X-ray energies, far from the optimal energy for a single silicon kinoform lens of 40 keV.

2. **Develop improved fabrication technologies that can more precisely shape diamond.** To fully take advantage of the unique X-ray and thermal properties of refractive diamond X-ray optics, improved fabrication technologies are needed.
3. **Consolidate the requirements of DOE labs for refractive lenses, and explore and encourage commercial development of single-crystal and vapor-deposited beryllium lenses.** Improvements in beryllium material (commercially available as a sintered powder) are desirable for several X-ray applications where coherence degradation and parasitic small-angle scattering are to be avoided. Brilliance-preserving single-crystal and vapor-deposited forms of beryllium that mitigate these effects have been demonstrated at the research level but are not available commercially. Ready availability of these materials will result in coherence-preserving and scatter-free lenses and windows.

## Scope

Refractive X-ray lenses can be used over a very wide energy range, from approximately 2 keV to over 100 keV, including use in the white beam from an insertion device. Refractive optics use the index of refraction of X-rays in a material to manipulate the X-ray beam and have been used in the conventional X-ray energy range (2-30 keV) as a complementary technique to other focusing elements such as mirrors, zone plates, and MLLs. As the photon energy increases from the conventional hard X-ray range to the high-energy X-ray range (50-100 keV and beyond), optics for the efficient control of X-rays become more challenging and refractive optics are especially attractive. Specifically, as the X-ray energy increases, the refractive index for X-rays becomes increasingly close to unity. This, in turn, means smaller grazing angles of incidence for mirrors, leading to longer and more unwieldy devices. It also means zone plates with increasingly fine features and longitudinally thicker structures that are very difficult to fabricate.

In this section on refractive optics, we consider not only the more standard refractive lenses that have no shape discontinuities, but also kinoform lenses, Clessidra lenses, and sawtooth lenses that do have discontinuities in their shape. For all of these lenses, it is essential to consider both the refractive index of the lens and its specific shape.

### X-RAY INDEX OF REFRACTION

For X-rays, the index of refraction,  $n$ , is close to, but slightly less than 1, and is often written as  $n=1-\delta-i\beta$ , where  $\delta$  is the real part of the refractive index and is associated with the phase shift of an X-ray beam, and  $\beta$  is associated with the absorption as it propagates through the lens material. Because the real part of the refractive index,  $1-\delta$ , is less than 1, a concave lens shape will be a focusing lens for an X-ray beam.  $\delta$  is given by  $\delta = \lambda^2 \rho r_0 / 2\pi$ , where  $\lambda$  is the wavelength of the X-rays,  $\rho$  is the electron density, and  $r_0$  is the Thompson scattering length or classical electron radius. Typical values of  $\delta$  are of the order  $\sim 10^{-6}$ , and so the maximum deflection angle of a single optical interface is the critical angle  $\theta_c = \sqrt{2\delta}$ , which is of the order  $10^{-3}$  radians or  $0.06^\circ$ . This is quite small compared with the more familiar large deflection angles in visible-light lenses made of glass ( $\theta_c$  for glass is  $\sim 42^\circ$ ). To produce small focal spot sizes, short focal lengths and larger apertures are necessary (see *Refractive X-ray Optics*, on the next page), implying a greater deflection of the X-ray beam. To obtain greater deflections with refractive optics, one either has to have significant lens curvature and, often, many lenses in series.

The imaginary part of the refractive index,  $\beta$ , describes the decay of the intensity of a beam as it propagates in a material. In the soft X-ray region ( $E < 3$  keV),  $\beta$  can be of the same order as  $\delta$ , making refractive optics impractical (but not impossible). A useful figure of merit for a material is the ratio  $\delta/\beta$ , which is the ratio of the phase shift one obtains from a slab of material, to the decay of intensity in the same slab. Higher values of this ratio mean better optical performance. For X-ray energy ranges where the photoelectric cross section is the largest contributor to  $\beta$ , the absorption decreases with energy as  $\sim E^{-3}$  and  $\delta$  decreases as  $\sim E^{-2}$ , and so, with increasing X-ray energy, the figure of merit of refractive optics improves, and hard X-ray refractive optics becomes an

attractive option. Eventually, with increasing energy, the photoelectric cross section becomes comparable to or smaller than the Compton cross section, and  $\beta$  no longer decreases as rapidly with energy and, consequently, the gains in optical performance are not as significant.

### X-RAY LENSES

The purpose of a lens or similar optical element is to modify the phase profile of a beam incident upon it. An ellipse is the ideal shape for a refractive lens that converts a parallel beam with phase fronts, consisting of planes perpendicular to the beam-propagation direction, to spherical phase fronts converging to a point focus. A parabolic shape is widely used, however, especially when absorption limits use of the full aperture of the lens, and only the profile near the optical axis is important. The simplest lens optical shape to fabricate is a sphere and the earliest refractive lenses were spherical. The parabola is the next-simplest shape and has the advantage of eliminating spherical aberrations. Other profiles may be of interest when neither the source nor the image is at infinity. In fact, the ability to compute and then fabricate unique lens profiles in silicon (or diamond or germanium) to maximize focusing performance is a key advantage of refractive optics.

After determining the best aberration-free profile, the challenge is to transfer that profile as precisely as possible to the lens material of choice. Even if the best aberration-free profile is chosen, surface roughness of the profile translates into errors in the phase profile, resulting in a reduction of focusing efficiency. The Maréchal criterion sets a target for phase errors of an optic. If the rms wavefront error is less than  $\lambda/14$ , the lens will behave as a diffraction-limited optic, but with reduced flux in the focal spot. When the wavefront error is greater than this, the focal spot is not as small as it should be. The precision and fidelity with which one transfers profiles to the lens materials is probably the most important manufacturing issue for practical production of X-ray optics.

Most refractive X-ray lenses have fixed surface profiles and are therefore chromatic. One exception is the sawtooth lens, which will be described later in this section. For other refractive-lens types, if one desires a fixed focal length, the number of lenses in the stack must be varied if the energy is varied during an experiment. A device called a transfocator, which was originally developed at the ESRF and has now been copied at other other sources mitigates this disadvantage by allowing the user to easily add or remove lenses. Another approach implemented for the planar refractive lenses is to fabricate an array of lenses optimized for different energies on a single wafer and switch among them as needed.

Refractive optics have found especially widespread use in Europe, where more than 1,000 lens units are used, for example, at the ESRF. Use is growing in the United States, especially at the Linac Coherent Light Source (LCLS), but is still small compared with Europe. This imbalance reflects the fact that refractive optics were pioneered [1] in Europe and beamline scientists there have had more exposure to their merits. These merits are:

- In-line operation (quick and easy to insert and align, remove, and then re-insert)
- Compact footprint
- No need for an order-sorting aperture and high efficiency (in comparison with zone plates)

### Refractive X-ray Optics

The index of refraction for X-rays in a material is close to but slightly less than 1. Because the real part of the refractive index is less than 1, a concave lens shape will act as a focusing lens for an X-ray beam. A parallel beam from a source infinitely far away with planar phase fronts is incident on a refractive lens. The lens material's refractive index and the lens's shape are designed to reshape the phase fronts on the exit side of the lens as arcs of a sphere, centered at the lens's focal point. The angular extent of the spherical segment is referred to as the numerical aperture (NA). Larger NAs give smaller focal spots, so making lenses with bigger NAs is desirable. As illustrated in the figure, larger NAs also yield more absorption in the lens material; X-ray refractive lens designs attempt to maximize the NA while minimizing absorption.

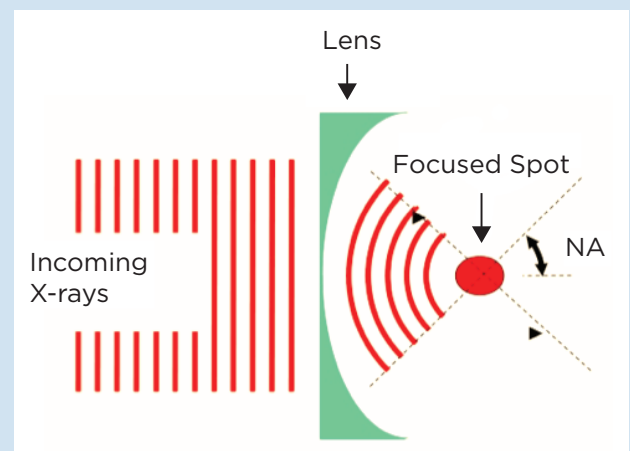

- Low relative cost
- Fabrication easily tailored to the specific problem to be solved
- Insensitivity to vibrations

The disadvantages of refractive lenses are:

- Chromaticity
- Absorption can be high (depending on X-ray energy and choice of material)

### ROTATIONALLY SYMMETRIC LENSES

The most widely used and commercially available refractive lens [2] is the CRL. They are primarily manufactured by Bruno Lengeler's group (originally) and now by a spin-off company called RXOptics. Each lens element is made by pressing a mandrel into beryllium or aluminum sheets. Because the refraction of X-rays in matter is very weak, a focal length in the meter range is achieved by choosing a small radius  $R$  at the apex ( $50\ \mu\text{m}$  to a few mm) and by stacking many individual lenses in a row. To minimize absorption in the lens, it must be made of a low-Z

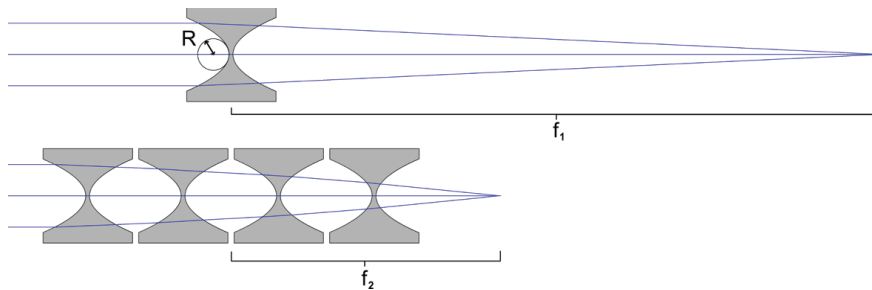

Because the index of refraction for X-rays is less than 1, focusing lenses for X-rays are concave rather than convex (as they are for visible light). The deflection from a single lens is small at X-ray wavelengths (top figure) and hence the focal length  $f_1$  is long and the spot size relatively large. Stacking multiple lenses (bottom figure) together (the so-called compound refractive lens or CRL) shortens the focal length (smaller spot size) at the expense of traversing more material (more absorption). ([www.X-ray-optics.de](http://www.X-ray-optics.de))

material. Lenses commercially available today typically have a parabolic shape. This is a significant improvement over earlier lenses with spherical or circular profiles and serves to significantly reduce spherical aberrations.

### PLANAR LENSES

A variety of lens-development efforts leverage planar technologies from the microelectronics industry. Because the technology platform is planar, the lenses developed are mostly cylindrical with a line focus. However, since synchrotron sources are asymmetric,

### Planar Silicon Nano-focusing Lenses

Several planar-lens technologies are based on processes the microelectronics industry uses for laying down electronic circuits on silicon. The patterning of various structures takes advantage of the precision of electron-beam and optical lithography and, in fact, the quality of the initial lithography of the hard mask is typically the best feature of this type of lens. To date, this has been done mostly in silicon and, to a lesser extent, in diamond and germanium. Even in silicon, the mainstay of the electronics industry, the precision of the deep etching needs significant improvement as there are often sloping sidewalls and edge roughness. Since the technology platform is planar, the lenses developed are mostly cylindrical lenses with line foci.

Right: A scanning electron micrograph of an array of parabolic refractive X-ray lenses made of silicon. The shaded areas (a) and (b) delineate an individual and a compound

nano-focusing lens. The optical axis is the white dashed line. (*Schroer et. al., APL, 2003*)

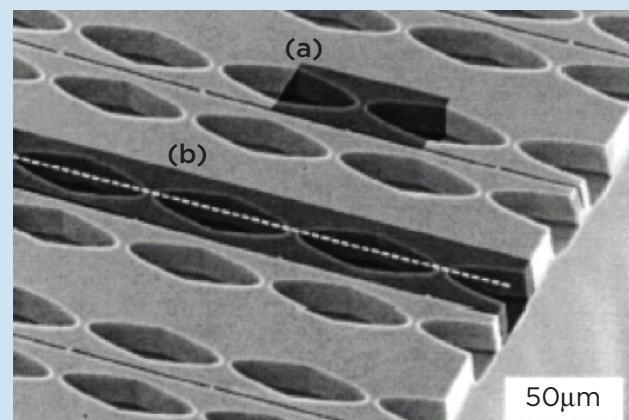

it is often an advantage to be able to separately focus the orthogonal directions. In fact, there is such a demand for cylindrical lenses that the Lengeler group, which originally pioneered rotationally symmetric CRLs, mounted a successful R&D effort to develop cylindrical lenses.

**Planar silicon nanofocusing lenses.** The silicon nanofocusing lens developed by Schroer [3] (see *Planar Silicon Nano-focusing Lenses*, previous page) is a lens array of parabolically shaped cylindrical lenses similar in concept to the beryllium CRL. The key difference is that one can create tighter radii of curvature with this method than with physical embossing, and consequently have shorter focal lengths (smaller focal spots). These lenses are made with electron-beam lithography and subsequent deep reactive-ion etching (DRIE).

**Planar diamond nanocrystalline lenses.** Another material with many potential advantages but many manufacturing challenges is diamond [4]. For typical hard X-ray energies, the refractive lens figure of merit,  $\delta/\beta$ , for diamond is very good. Moreover, for white- or pink-beam applications, diamond has excellent thermal properties. Diamond is, however, a notoriously difficult material to obtain and work with. Attempts to fabricate diamond lenses have been made by several groups over the past decade. Both etching and deposition have been tried. Diamond lenses have higher effective apertures than silicon due to lower absorption, but the etch depths are much smaller than in silicon. Deposition of microcrystalline or nanocrystalline material, on the other hand, can deliver larger lenses. The maximum lens thickness (etch or fill depth) achieved to date is 50  $\mu\text{m}$ .

**Planar silicon kinoform lenses.** While solid refractive lenses have many advantages, they have one fundamental limitation — the absorption ( $\beta$ ) by the lens material. The absorption results in a reduction in numerical aperture, limiting the resolution of an optic. A way around this limitation is to use a kinoform [5,6] structure, a design frequently used in visible-light optics. The figure at right shows a comparison of a solid refractive optic with its corresponding kinoform, in which sections of material that contribute one or more multiples of a  $2\pi$  phase shift are omitted, improving the transmission. Thus, the kinoform will have a larger numerical aperture and smaller focal spot size than the corresponding solid refractive optic. However, the kinoform shape introduces a trade-off between transmission and energy tunability: The phase shifts will only be  $2\pi$  for precisely one energy. To mitigate this problem, one can fabricate arrays of optics optimized for different energies and easily translate from one to another, because each lens is small. In addition, there are many focusing applications such as coherent diffraction imaging, X-ray photon correlation spectroscopy, and inelastic X-ray scattering in which the technique is typically performed at fixed photon energy so this issue is irrelevant.

**Planar LIGA refractive lenses.** (See *LIGA Planar Lenses*, above) Using LIGA, some creative refractive lens structures [7] have been fabricated. These lenses are fabricated with SU-8, the workhorse photoresist for LIGA

### LIGA Planar Lenses

The top row shows an array of planar refractive lenses (gray) with X-rays schematically (red) incident on the lenses from the left resulting in a line focus on the right. The middle row of lenses is a novel scheme in which the refractive lenses are fabricated at a  $45^\circ$  angle with respect to the substrate. In the middle row, the first set of 7 lenses are tilted  $-45^\circ$  with respect to the plane and the second set are tilted  $+45^\circ$ . This allows one to focus in two orthogonal directions even though the lens array was made using planar technology. The third row interleaves the lenses and removes one drawback of the scheme presented in the second row, namely that the focal spots in the orthogonal directions are at different locations (astigmatism). ([www.X-ray-optics.de](http://www.X-ray-optics.de))

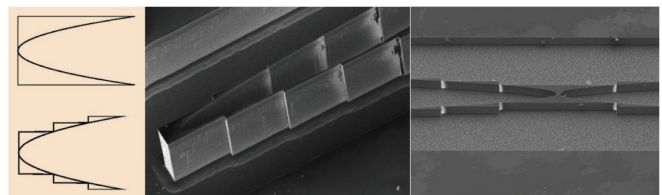
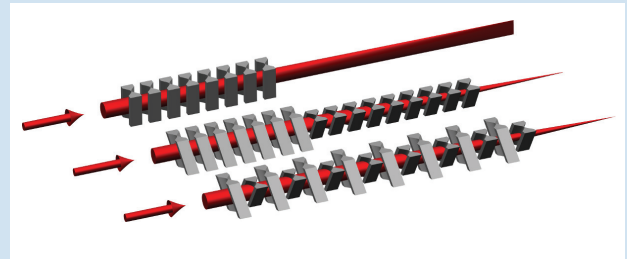

**Left:** A comparison of the solid refractive shape (top) with a kinoform shape (bottom). **Middle:** A parallel-to-point kinoform lens. **Right:** A point-to-point kinoform lens. (*Evans-Lutterodt et al., 2003*)

## X-ray Photon Correlation Spectroscopy

In XPCS, a sample is illuminated with a coherent X-ray beam, which results in a speckle pattern superimposed on the sample diffraction pattern. The exact positions of the speckles depend on the instantaneous state of the material. Time fluctuations of the density distribution lead to fluctuation of the speckle pattern. By performing a time-autocorrelation on the intensity of the speckles it is possible to obtain quantitative information about the dynamics of the sample.

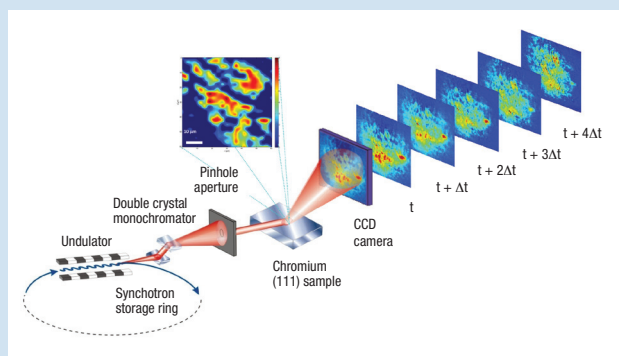

The figure below shows the normalized speckle produced by a large unfocused beam (circles and solid line), a small unfocused beam (squares and dashed line) and a large unfocused beam (crosses and dot-dashed line). The focused beam greatly improves the experiment today, and with improved refractive optics, allows access to time scales nearly 100X faster than is accessible today.

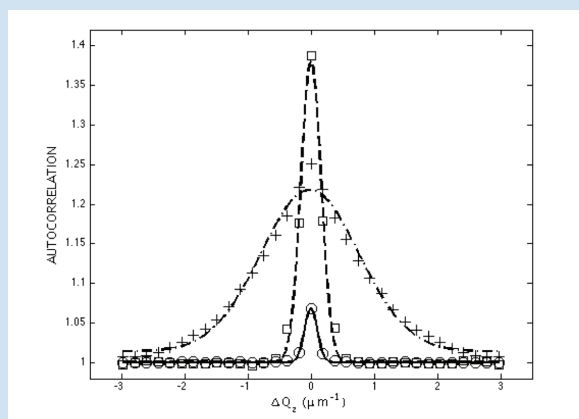

An important extra feature of focusing for XPCS is that it makes the scattered modulation bigger and far easier to resolve. This is especially important because the fastest applicable detectors that are just now appearing on the market have far less resolution than the slower detectors that have been used previously.

that allows large-aspect-ratio structures. A potential disadvantage of SU-8 lenses is precisely the feature that allows them to be fabricated: sensitivity to X-ray radiation.

The concern is that the lens will degrade in the beam with time. We note, however, that lenses made from SU-8 have survived and performed for many years in the inelastic scattering beamline at SPring-8. Another disadvantage is that there are heavy atom (antimony) impurities in the resist material, leading to significantly higher X-ray absorption than might otherwise be expected for carbon-based SU-8. Work is in progress, however, to reduce such impurities. Advantages of this type of lens are (1) there is considerable experience using this material to fabricate “deep” structures, (2) the material is flexible so the planar-fabricated lenses can be converted to 2-D lenses (see below), and (3) the SU-8 lenses can be plated with nickel, for example, so they can be used at higher X-ray energies.

## PRISM-BASED SAWTOOTH X-RAY LENSES

The sawtooth refractive lens [8] possesses some unique characteristics, including continuous tunability. This refractive lens is based on the principle that a tilted triangular sawtooth structure, when viewed with respect to the beam, presents an effectively parabolic thickness profile (in longitudinal projection) as required for aberration-free performance. A full parabolic profile is obtained by placing two such sawtooth structures face-to-face, but tapered symmetrically about the beam axis. Tunability of focal length or a fixed focal length for variable energy is easily accomplished by symmetric adjustment of the taper angles of the two pieces, which effectively alters the osculating radius of the parabola. In addition to being parabolic and tunable, the device also has no attenuation on-axis. This is in contrast to the case of other CRLs where even on-axis there is a minimum thickness that attenuates the X-ray beam. This type of lens has been found to be particularly useful in high-energy diffraction beamlines [9].

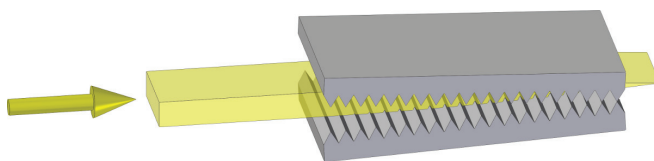

A sawtooth lens is a tilted triangular sawtooth structure that, when viewed along the beam propagation direction, presents an effectively parabolic thickness profile. This type of lens has a focal length that is continuously tunable by varying the opening angle of the aperture. ([www.X-ray-optics.de](http://www.X-ray-optics.de))

### PRISM-BASED CLESSIDRA LENS

A Clessidra (“hourglass” in Italian) lens is an interesting optic made of multi-prism arrays [10]. It can be shown that the deviation of an X-ray beam deflected by a row of prisms can be more than the critical angle of the prism material. In other words, the numerical aperture of such a lens, which is twice this deflection angle, can be several times the critical angle. With such a large numerical aperture, if one could keep phase errors below the Maréchal criterion, then nanofocusing to exceptionally small foci on the order of 10 nm is in principle possible. The path to achieve such suitably perfect optics is unclear. This structure still has merits because the numerical aperture is very large.

### PRISM-BASED NEAR-ROTATIONALLY SYMMETRIC CONDENSER LENS

The prism-based lens optics fabricated by planar technology are naturally line-focusing optics, but a 2-D collimator can be made using 1-D prisms prepared in flexible materials. Simon et al. [11] and Nillius et al. [12] have demonstrated this. In this lens, one fabricates the arrays of prisms using planar technology out of flexible polymers, and then rolls up the resulting flat structure into a rotationally symmetric structure. The phase preservation of this lens is poor, but it is well suited as a condenser lens for a full-field X-ray microscope.

## High-energy Diffraction Microscopy

High-energy diffraction microscopy or HEDM is a powerful tool for the study of real materials on scales from the atomic level to millimeters. The high-energy X-rays penetrate millimeter dimensions while providing large coverage of reciprocal space with a relatively small detector. Actually, HEDM is made up of three separate techniques: near-field orientation microscopy (left box), far-field lattice strain measurements (middle box), and absorption micro-tomography (right box). In combination, they can be used to map grain orientation and position under applied stress and/or temperature. By quantifying the initial microstructure and stresses in a material and initializing models with this data, detailed comparisons of sample evolution under applied thermomechanical stress can be made between experiment and simulations. This is a key component to the development of refinements in model validation.

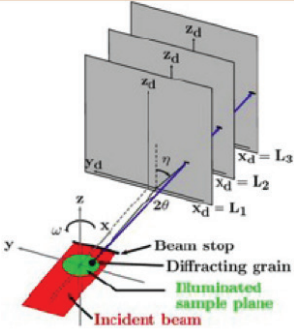
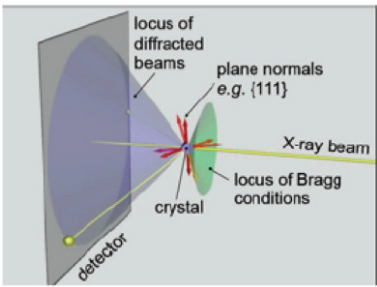
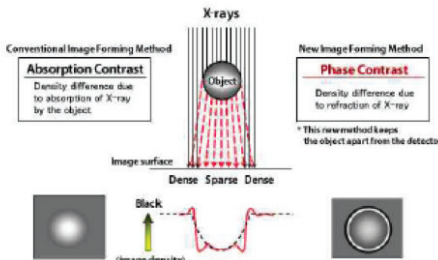
Near Field Orientation Microscopy	Far Field Lattice Strain Techniques	Absorption Micro-Computed Tomography
		
<p><b>Provides:</b> grain shapes, subgrain orientation, subgrain strain</p> <p><b>X-ray Char.:</b> Line focused beam (~ 1.5mm x 2μm)</p> <p><b>Collection:</b> Take image at N different distances and rotate M times (NxM images). Move sample vertically to build up 3D volume</p> <p><b>Processing:</b> Reconstruct distinct diffraction spots on detector</p>	<p><b>Provides:</b> grain volume, centroid, orientation, strain for individual grains</p> <p><b>X-ray Char.:</b> Both line focused and box beam</p> <p><b>Collection:</b> Take image during M rotation increments. Move sample vertically to build up 3D volume using line beam</p> <p><b>Processing:</b> Back projection of diffraction spots w/ grain precession</p>	<p><b>Provides:</b> position/size of Inclusions, voids, cracks</p> <p><b>X-ray Char.:</b> Both line focused and box beam</p> <p><b>Collection:</b> Take image during M rotation increments. Move sample vertically to build up 3D volume using line beam</p> <p><b>Processing:</b> Back projection of contrast within 2D image (mm<sup>2</sup>) of direct beam</p>



## Issues

X-ray photon correlation spectroscopy (XPCS) is an experimental technique for the characterization of real-time structural changes in materials (see *X-ray Photon Correlation Spectroscopy* in this chapter). Because it is a time-domain technique, it is very sensitive to the motion of the focusing optics (and any other beamline motion). Refractive lenses, being in-line optics, are ideal optics for XPCS because the focused beam is insensitive to any parasitic motion of the optics. This is not the case for single-focusing mirrors, while multiple-mirror systems add extra phase perturbations on the X-ray beam. With improved CRLs, the coherent flux on the sample could be increased to the point where XPCS could access biophysical times to study, for example, the diffusion of proteins in dense solution that are relevant to the onset of cataract formation.

The characterization of real materials spans a wide range of length scales, from atomic crystalline structure to macroscopic structures such as grain boundaries, segregation, and dendritic growth. A better understanding of these properties can lead to enhanced materials processing and improved performance through validation of simulations and models. High-energy diffraction microscopy (HEDM) is an ideal tool to characterize such materials. HEDM (see *High-energy Diffraction Microscopy* on previous page) requires a beam of high-energy X-rays (50 to 80 keV) with both a line focus (typically 1 mm x 2  $\mu\text{m}$ ) and point focus (typically a few microns by a few microns). At these energies, refractive lenses are an attractive option. They have the convenience of operating in an in-line geometry, unlike total external reflection mirror schemes (e.g., Kirkpatrick-Baez or Montel). In addition, at high X-ray energies, mirrors have issues with sub-microradian slope errors and multi-kilometer radii of curvature. HEDM experiments often require energy tunability, and sawtooth refractive lenses meet this requirement. For high energies and short focal lengths ( $<2$  m, as typically needed for a  $\sim 1$   $\mu\text{m}$  focus), an aberration arises in sawtooth lenses. Due to the required grazing tilt angle of the lens, its length becomes non-negligible relative to the focal distance, whereas the theoretical validity of the sawtooth concept is based on it being close to a zero-length device or thin lens. CRLs, in contrast — even when taking on the physical form of comparably long stacks of elements — do not in principle have such an aberration because they can clearly be conceptually decomposed into thin lenses.

Both these techniques and others would benefit from improved refractive optics. Listed below are specific problems of the different types of refractive optics that, if addressed, would result in improved outcomes for users of these techniques.

**Compound beryllium lenses.** Pressed beryllium lenses are currently in wide use; more than 4,000 lenses have been delivered to beamlines around the world. At present, these lenses are made with sintered beryllium that contains voids, inclusions, grain boundaries, and other scattering centers that are sources of small-angle scattering. This incoherent small-angle X-ray scattering (SAXS) produces a background, reducing the contrast from focused coherent beams and hence limiting their application to moderate demagnifications. Reducing this scattering will lead to improved performance. Ongoing efforts are focused on reducing this scattering by producing beryllium lenses from single-crystal material (rather than material produced via hot isostatic pressing of powder). It is a challenge, however, to obtain sufficient quantities of single-crystal beryllium.

**Planar technologies.** One area that needs improvement for both silicon and germanium planar optics is the depth and quality of the DRIE etch. Because electron-beam lithography is quite precise (20-nm positional accuracy), the most significant errors are introduced in the etch process. The issues with DRIE are the etch depth, the slope of the etch sidewalls, and the roughness of the sidewall. Current maximum etch depths are in the 90-100- $\mu\text{m}$  range. To collect a substantial fraction of the light from a third-generation source like the Advanced Photon Source (APS), an optic should be  $2.4\sigma L$  wide, where  $L$  is the distance from source to optics and  $\sigma$  is the source divergence. The horizontal source divergence is of the order 10  $\mu\text{rad}$ , and  $L$  is of the order 30 m, giving us a target etch depth of the order 500  $\mu\text{m}$  or more.

**Nanodiamond.** The main issues with nanodiamond lenses are that the maximum thickness of the lens is only 50  $\mu\text{m}$ , and there is strong parasitic scattering due to the presence of voids. In addition, voids do not allow a proper definition of lens focal length due to changes in the material filling.

## R&D Directions for the Future

### MATERIALS

**Beryllium.** Commercial grades of beryllium are formed from sintered powders and produce parasitic scattering that limits their use to moderate demagnifications. Single-crystal and vapor-deposited beryllium are alternatives that warrant investigation. These materials are generally free of voids, inclusions, and other scattering centers. In fact, the use of single-crystal beryllium as a window material has been investigated at the APS where, in collaboration with industrial partners, highly polished single-crystal beryllium windows were developed and tested. In addition, vapor-deposited beryllium has been investigated at SPring-8 in Japan. In both cases, these materials exhibit excellent performance compared with commonly available beryllium grades.

The main obstacle to the development and use of such materials is their limited availability. One way to move forward would be to consolidate requests from across the various DOE labs to generate a larger and more attractive market for vendors. Another obstacle is the required fine machining and finishing of single-crystal beryllium lenses owing to the material's low mechanical strength (due to its weak cleave planes). Neither of these obstacles is a showstopper, and with proper effort and funding, high-quality single-crystal lenses (and windows) can be produced.

**Diamond.** When considering the choice of a lens material for typical hard X-ray applications, the best choice is often beryllium. Diamond, however, has much better thermal properties, with high thermal conductivity ( $k$ ), a low thermal-expansion coefficient ( $\alpha$ ), and a high melting point. These properties may be important if the lens is to be exposed to the white beam from an undulator. Materials can be thermomechanically ranked by the figure-of-merit ( $k/\alpha$ ). At room temperature, the figure-of-merit of diamond is 100 times better than that of beryllium. Diamond's improved figure-of-merit dramatically reduces the effect of heating due to absorption in the white beam. The main limit to applying diamond is finding materials of sufficient quality to minimize parasitic scattering.

### PLANAR FABRICATION METHODS

A major breakthrough in design and fabrication of a quality focusing or collimating lens made of diamond will require further effort in fabrication, for both mask technologies and etch processes. Attempts to fabricate diamond lenses have been made by several groups in the past decade. Both etching and deposition are being used. Diamond lenses have higher effective apertures than silicon but much smaller etch depths. Deposition of microcrystalline or nanocrystalline material, can deliver thicker lenses. The maximum lens thickness achieved up to now is 50  $\mu\text{m}$ . The main drawbacks of micro- and nanocrystalline diamond are small-angle X-ray scattering and the presence of voids that do not allow a proper definition of lens focal length due to changes in material filling. Vapor deposition is a promising R&D direction for fabricating refractive diamond lenses via the deposition of diamond in "molds" made by LIGA processes. Alternatively, lenses may be laser cut from single-crystal material, but work will be required on smoothing the laser-cut edges.

### SAWTOOTH LENSES

The development of sawtooth lenses is an important avenue to follow due to their straightforward tunability. The main emphasis would be in mitigating the above-mentioned finite-length aberration by adjusting the sawtooth profile.

## Impact

XPCS is the X-ray analog of dynamic light scattering, but performed with X-rays. As such, it is sensitive to spontaneous fluctuations at the nanoscale in condensed matter and can be used to study chemical, magnetic, and structural fluctuations in materials. The effectiveness of XPCS measurements depends on the square of the intensity of the coherent X-ray beam incident on the sample and the size of the beam, which, ideally, should be a few microns in size. Since measurements are made in the time domain, the focused beam must also be vibration free. Coherence-preserving CRLs are the ideal optic to achieve these requirements. Focusing allows XPCS experiments to accept more of the coherent flux provided by the sources. At the same time, it reduces the beam to a size ideal for subsequent detection in suitable detectors. The unique feature of the CRL, though, is that it provides these benefits as an in-line optic that is much less sensitive to vibration than the equivalently focusing mirror that would have a very long lever arm. Continued growth and new applications of XPCS will result directly from the application of refractive lenses.

Another application of the gentle, position-invariant focusing provided by refractive lenses is in microbeam protein crystallography. An array of refractive lenses placed at a few locations along the beamline would allow the focal size of the beam to be easily varied from a few micrometers to the full size of the X-ray beam without any displacement of the beam at the sample position. Being able to focus and defocus the beam without moving it is absolutely critical to this technique. Improved refractive lenses could reduce minimum beam sizes by a factor of 2 or 3 from what is provided today. Line focusing of X-rays is also being explored as a mitigation approach to radiation damage in macromolecular crystallography by attempting to direct the photoelectrons produced by the incident X-ray beam out of the sample. Initial results indicate the line-focus approach has reduced damage by a factor of 4.

Development of high-quality refractive lenses could have a significant impact on research using high-energy X-rays. High-energy X-rays can easily penetrate windows on furnaces and containment vessels for radioactive samples and allow a large Q-range to be accessed when exit ports are limited in size. Historically, materials characterization has only been performed in two dimensions. Focused, high-energy X-ray beams have an opportunity to change that, as they can probe a material's microstructure in a nondestructive way that can provide unique data, revealing mesoscale response mechanisms critical to performance in extreme environments. Having the optical components to provide a high-quality, focused beam is key to the success of this technique.

## References

1. V. Snigirev et al., *A compound refractive lens for focusing high-energy X-rays*, Nature 384, 49-51, 1996.
2. B. Lengeler et al., *Imaging by parabolic refractive lenses in the hard X-ray range*, J. Synchrotron Rad. 6, 1153-1167, 1999.
3. C.G. Schroer et al., *Nanofocusing parabolic refractive X-ray lenses*, Appl. Phys. Lett. 82, 1485, 2003.
4. L. Alianelli et al., *A planar refractive X-ray lens made of nanocrystalline diamond*, J. Appl. Phys. 108, 123107, 2010.
5. V. Aristov et al., *X-ray refractive planar lens with minimized absorption*, Appl. Phys. Lett. 77, 4058-4060, 2000.
6. K. Evans-Lutterodt et. al., *Single-element elliptical hard X-ray micro-optics*, Optics Express 11, 919, 2003.
7. V. Nazmov et. al., *Planar sets of cross X-ray refractive lenses from SU-8 polymer*, Proceedings of SPIE 5539, 235-243, 2004.
8. B. Cederström et. al., *Focusing hard X-rays with old LPs*, Nature 404, 951, 2000.
9. S.D. Shastri et al., *High-energy X-ray optics with silicon saw-tooth refractive lenses*, J. Synchrotron Rad. 14 (Pt 2), 204-211, 2007.
10. W. Jark et. al., *Focusing X-rays with simple arrays of prism-like structures*, J. Synchrotron Rad. 11, 248-253, 2004.
11. M. Simon et. al., *A new type of X-ray condenser lens with large apertures fabricated by rolling of structured films*, AIP Conf. Proc. 1221, 85-90, 2010.
12. P. Nillius et al., *Large-aperture focusing of high-energy X-rays with a rolled polyimide of film*, Opt. Lett. 36, 555-557, 2011.

# Models for Facility Operations and Interlaboratory Coordination



## Summary

Development of optics capabilities within the U.S. Department of Energy (DOE) national laboratory complex has progressed in an uncoordinated manner, without specific intent to conform to any of the models proposed in this chapter. Some types of optics capabilities, such as the ability to fabricate multilayer and thin-film coatings and to precisely measure low-spatial-frequency errors in mirrors, are available at several DOE laboratories, but not all. Some capabilities, such as adaptive optics and crystal-optics fabrication, are available only at a single laboratory. These capabilities generally have been developed in response to a specific need to support a particular laboratory's science facilities.

### Working Group Chairs:

M. Pivovarov (LLNL)  
J. Arthur (SLAC)

### List of contributors in alphabetical order:

L. Assoufid (ANL)  
O. Chubar (BNL)  
D. Cocco (SLAC)  
R. Conley (ANL / BNL)  
M. Idir (BNL)  
J. Krzywinski (SLAC)  
P. Naulleau (LBNL)  
H. Padmore (LBNL)  
T. Rabedeau (SLAC)  
R. Soufli (LLNL)  
J. Susini (ESRF)  
T. Toellner (ANL)  
T. Warwick (LBNL)  
V. Yaschuk (LBNL)

## Recommendations

1. **With input from facility managers and DOE Basic Energy Sciences (BES) staff, organize consortia in the various areas of optics and have them submit white papers to BES describing how best to move forward on improved X-ray optics.** Specific proposals are needed to define detailed program goals and impacts, develop management plans, and determine funding requirements for a coordinated model for optics development. A forum of technical experts, with input from facility managers and BES staff, would be the appropriate venue for the development and submission of proposals.
2. **Initiate a single program to serve as a pathfinder and prototype for cross-laboratory collaborations.** All of the laboratories require advanced modeling and simulation capabilities and have already started coordinating R&D activities at the individual scientist level. Given this "head start," only modest funding and effort are needed to launch a virtual center responsible for creating, maintaining, and distributing simulation tools and analysis software for X-ray optics. This virtual center would not be expensive to implement and could serve as a test bed for management and funding schemes. It could be the first of the proposals mentioned in Recommendation 1.

## Scope

To design, create, and analyze state-of-the-art X-ray optical systems requires sophisticated and expensive laboratory equipment and highly trained, dedicated personnel. What model or models of support should BES adopt to ensure that its user facilities have access to advanced X-ray optics, while maximizing efficiency and minimizing costs? This chapter will consider this question in detail.

To stimulate discussion, we have developed four potential models to coordinate efforts across the entire DOE complex for the purpose of providing optics capability to the BES light-source laboratories. Each model has advantages and risks, and it is possible that for some required

activities, none of these notional models will be appropriate for managing optics development. These models are elucidated in the *Discussion of the Models* section that follows. We believe that dedicated interlaboratory partnerships are essential for delivering the next generation of X-ray optics instrumentation and that these models or similar ones merit exploration. As one of our recommendations, we propose that BES create an initiative, focused on one of the X-ray optics topics discussed in the earlier chapters, to serve as pathfinder to learn how well such a multilaboratory system works.

## Introduction

BES X-ray user facilities provide unique instrumentation, including X-ray optical components, for state-of-the-art scientific research. The requirements placed on optical components often push the limits of what can be reliably fabricated, with specifications that tax existing metrology capabilities. In particular, fabrication of X-ray optics that are well-matched to upgraded third-generation and new fourth-generation light sources often requires characterization that lies beyond the limits of what can be measured. DOE national laboratories have generally been leaders in pushing the state of the art in optics metrology and developing new optics techniques. The effort has taken place in an ad hoc and serendipitous manner, often driven by the needs of a particular facility at a particular laboratory, and spearheaded by a few scientists. The results have been impressive, but the cost is not small (an advanced X-ray optics laboratory costs several million dollars to set up, and requires specialized, dedicated personnel to keep it going) and there is concern that the lack of coordination may lead to inefficiencies and duplication of effort.

Realizing that tighter budgets are likely, better interlaboratory coordination and collaboration will be essential to continue innovation and to meet emerging needs. Cooperation among DOE laboratories through centralization of some capabilities can address inefficiencies, provide critical mass, and generate sufficient work to justify expensive optics facilities. However, centralization of services can also lead to problems. Coordination requires setting priorities, with the risk that a laboratory may lose control over resources vital to the success of its science. Coordination also requires good communication, with the risk that centralized services may not meet all the needs of a particular laboratory. In addition, a funding model must be developed for centralized services that are located at one laboratory but are delivered to many. The model must include a source of stable funding for staff during periods of fluctuating demand and simultaneously provide support for the required fundamental R&D for new optical components.

## Discussion of the Models

We propose four potential models for managing the simulation, development, fabrication, and evaluation (including the entire supporting infrastructure) of X-ray optics required for BES user facilities. It is expected that different models will be best for different types of optics activities and that fulfilling all BES light-source needs will require a diversity of models.

1. **Core Competency.** This model is appropriate for addressing needs specific to an individual laboratory such that there is an advantage for the optics capability to be co-located to the place where the optics will be used. In this model, the optics facility is located within one laboratory, and its mission and capabilities are determined entirely by that laboratory to support its local light source(s).

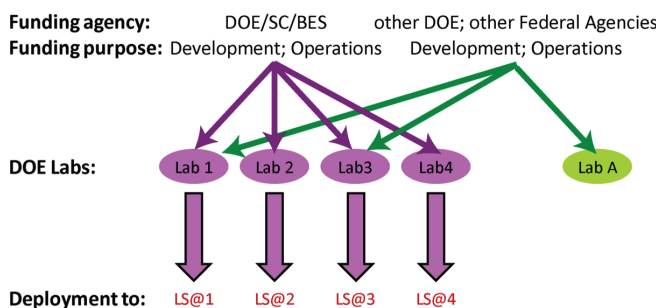

**Core Competency model.** Purple and green arrows show flow of funding from various sources to SC/BES laboratories (purple, labs 1–4) and other DOE laboratories (green) to support and develop a capability. Each laboratory directly delivers a capability, indicated by the purple block arrows, to its local light source(s).

2. **Virtual Center.** This model works well when the capability can be used remotely. Analysis software, simulations, and other forms of computer support for optics development fall into this category. In this model, developments that happen at many laboratories are centrally stored and managed, and made available to the entire DOE complex. Funding for the fundamental R&D that will take place at multiple laboratories could include direct funding from BES, internal laboratory funding, or other sponsors. Central funding would be required for a few activities, including integrating, testing, validating, and documenting software and simulation packages; and developing and maintaining the infrastructure (e.g., computer equipment for storage and distribution, a Web portal and a Help Desk) required for distribution of software and packages throughout the laboratory complex.

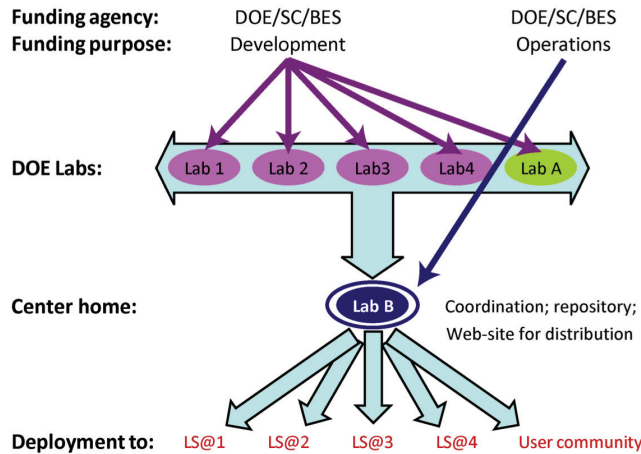

Virtual Center model. Purple arrows show flow of funding from BES to individual laboratories (BES laboratories indicated by purple, other DOE laboratories indicated by green) to support R&D to develop optics capabilities. The dark-blue arrow shows funding from BES to one of the BES laboratories, for central coordination and management of the optics capabilities developed across the complex, and for dissemination of this capability to the light sources and the user community.

3. **Regional Leader.** This model best describes how most optics capabilities are distributed today within the DOE complex. A capability developed at one laboratory is made available to other laboratories, and those nearby make effective use of it. It is appropriate for a capability that is needed infrequently (e.g., the fabrication of specialized “one-off” optical elements) and is transportable to some extent. Though some effort has been made to spread the cost of supporting a regional capability by charging for services through interlaboratory agreements, there is currently no transparent mechanism for long-term, stable funding for capabilities developed at one laboratory but relied on by others. In addition, the capabilities developed tend to reflect the needs and priorities of the laboratory at which the facility is based, with no reliable mechanism for input from outside laboratories on strategic goals and future research directions.

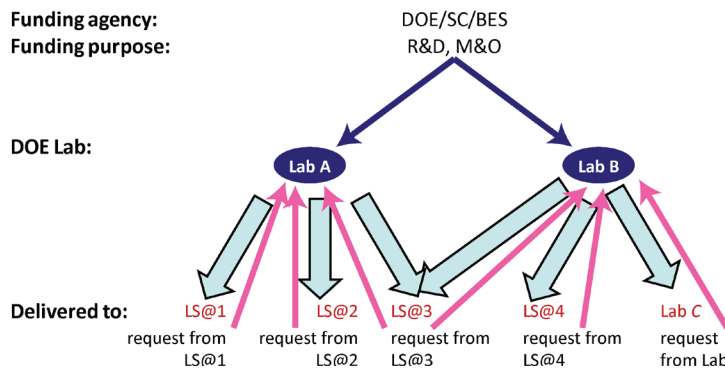

Regional Leader model. Dark-blue arrows show flow of funding from BES to the regional centers, which are likely located at BES laboratories, for general support of their capabilities. Light-blue block arrows show flow of the optics capability to various light sources, and the pink arrows indicate the tasking requests generated by each light source.



4. **National Capability.** This model works best for capabilities so expensive or unique that duplication is not justified. To work effectively and reliably, this model requires a special funding mechanism so that the optics capability is self-supporting and is not required to justify its existence within the priorities of a single laboratory.

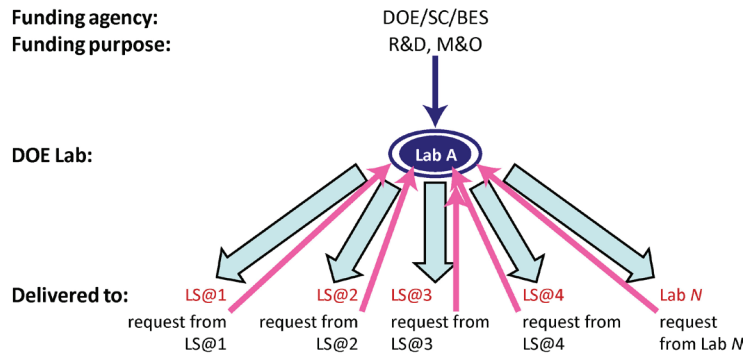

National Capability model. The dark-blue arrow shows flow of funding from BES to the national center, which can be located at any DOE laboratory for general support of its capabilities. The light-blue block arrows show flow of the optics capability to various light sources, and the pink arrows indicate the tasking requests generated by each light source.

## Which model?

As mentioned above, development of optics capabilities within the DOE laboratory complex has so far lacked coordination, with no specific intent to conform to any of the models described above. Some types of optics capabilities — multilayer and thin-film coatings deposition and precision metrology techniques — are available at several laboratories but not all. Some capabilities, such as adaptive optics and crystal-optics fabrication, are available at only a single laboratory. Many national laboratories, including all of the BES light-source laboratories, have some ability to carry out optics modeling and simulation. These capabilities have generally evolved in response to a specific need at each laboratory to support its science facilities.

While a noncentralized approach may work relatively well for the Core Competency model, in which each laboratory determines its needs and develops capabilities to meet them, the other models require some form of central direction.

There has been no effort to centrally direct the development of optics at the national laboratories. We now believe several factors, including constrained budgets and the need for expertise and capabilities that are distributed across the complex, favor deliberative coordination. There is already a relatively clear mapping of some of the models above to the areas of X-ray optics listed in this workshop. The fabrication of zone plates, for instance, requires very expensive infrastructure such as nanolithography, and resources could be centralized as in Model 4 for distribution to all other laboratories. Crystal-optics fabrication might be focused in one or perhaps two centers, i.e., Models 3 or 4. On the other hand, theory and simulation naturally lends itself to a virtual center as described in Model 2.

Other mappings are less clear at this time and will need further analysis. We propose that as a follow-up to this workshop, a small working group conduct a survey of existing optics capabilities within the national laboratory complex. For each identified optics group or optics capability, the working group would determine the existing customers, identify the current funding source, and discuss with laboratory management the prospects for adapting the capability to fit within one of the models described above. The group would also work with laboratory management to identify current and anticipated needs for optics capabilities not currently available to them, and to discuss which management model would best satisfy the unmet needs.

This process should lead to specific proposals for optics centers, with clear definition of the services that would be provided, the long-term research program, management plans, and funding requirements to ensure the center's capabilities are distributed to other laboratories. A team of technical experts, facility managers, and BES

staff members would be the appropriate group to study each area discussed in this Workshop Report and then recommend areas in which proposals should be developed.

As a prototype for a coordinated model, we recommend initiating a virtual center for modeling, simulation, and theory. All of the laboratories require these capabilities and have already started coordinating R&D activities in an ad hoc manner. Given this head start, only modest funding and effort would be necessary to launch a virtual center for optics simulation and analysis software in the near future. Such a virtual center would not be expensive to implement, and could serve as a test bed for management and funding schemes.

This workshop served as an ideal venue to bring together optics experts from national laboratories, universities, and industry to talk with one another, share ideas, and debate the virtues and potential problems of coordinating R&D activities. We suggest this be a first step in formalizing discussions and cooperation among the laboratories to address the challenges in creating the X-ray optics needed to harness the full potential of current and future BES X-ray user facilities.

# Industry



## Summary

Optical elements are used to transport, focus, and monochromatize X-rays from free electron laser (FEL) and synchrotron light sources, and to analyze X-rays emitted or scattered from samples. Although optics are vital components of beamlines and experiments, their cost is a small fraction of total beamline cost. In addition, only a few beamlines are constructed each year, and so the total commercial value of optics purchased throughout the DOE light sources is quite modest, on the order of \$5 million/year. Yet within this total, a wide diversity of optics is required. This is in contrast to other areas of high-precision optics. For example, the 18 segments of the James Webb Space Telescope primary mirrors cost approximately \$10 million each, and are identical. The

prototype small-field double-mirror objective optics for extreme ultraviolet (EUV) lithography R&D systems cost approximately \$13 million each. The large-field optics deployed in microelectronics-fabrication facilities cost approximately \$50 million and are widely duplicated. FEL and synchrotron optics, on the other hand, have tolerances that are at or even beyond the state of the art; there is a huge diversity in specifications based on the large range of beamline applications; and the total volume is low. This creates a range of issues in procuring optics — mainly an insufficient motivation for industry to develop the range of optics needed to meet the challenges of upgraded and next-generation coherent light sources. Here we outline a range of issues, and in the following section we recommend a few directions that should be pursued with high priority.

### Working Group Chairs:

K.A. Goldberg (LBNL)

A. Khounsary (ANL)

### List of contributors in alphabetical order:

D. Bajuk (Zygo)

M. Feser (Xradia)

Y. Platonov (Rigaku)

J. Robichaud (L-3 Communications)

D. Smith (Plymouth Grating Lab)

J. Tabeling (Delaware Diamond  
Knives)

T. Tonnesson (InSync)

M. Tricard (Zygo)

## RECOMMENDATIONS

- 1. Collectively define the needs of the X-ray optics community for industry.** The DOE X-ray community must coordinate across facilities to develop specifications for standardized optics. This will reduce duplication of effort and allow the attainment of a critical mass in each type of optic so economies of scale can be exploited.
- 2. Enhance collaboration in key areas.** Where appropriate, collaborate with industry for the development of advanced X-ray optics to leverage external capabilities, expedited development, and cost advantages. For example, an impediment to progress in high-accuracy optics is the availability of suitable in-fabrication metrology. This is an area where an active industry-DOE laboratory collaboration could have significant impact by lowering the barriers to providing advanced metrology at the manufacturing site.
- 3. Reduce contractual barriers where possible.** Seek ways to reduce barriers to collaboration; streamline contracting and technology transfer. Many technologies developed and used by national laboratories could be very useful to industry. However, current barriers hinder this effort — mainly, the cost of technology transfer. Small Business Technology Transfer (STTR) offers a good route to this transfer, if guided into key areas in X-ray optics research and development.
- 4. Incentivize interactions with industry.** Attract industry cooperation with access to facilities, personnel, and expertise. Facility performance

metrics should recognize industrial collaborations in research and development, as well as the metrics used today that are based on published scientific impact.

- 5. Strategize closely with industry partners.** The optics industry today is a tool used by the X-ray facilities. Industry currently lacks perspective on the planning for light-source development, which ranges from near-term beamline construction to long-term facility development. A closer industry interaction with facility and DOE planners would make planning for upgrading of manufacturing facilities for projected needs much easier.

Significant progress toward some of these objectives was made at the March 2013 DOE X-ray Optics Workshop. A major conclusion was that regular meetings at this level can significantly help to break down barriers between industry and the DOE X-ray facilities. An important recommendation, therefore, is to continue such meetings as annual or bi-annual events.

We would benefit enormously from a much closer interaction between optics manufacturers and DOE X-ray facilities, so that jointly new technologies could be more freely developed, and industry can do a better job of planning for the future.

## DOE & Industry Interactions

U.S. industry can make a significant contribution to the development of X-ray optical elements and systems that are beyond the current state of the art. Recognizing that a coordinated effort will be more effective than isolated interactions, a working group was charged with studying how to optimize public-private partnerships to leverage commercial capabilities and expertise that are outside of the national laboratories.

Thanks to the many national laboratory and industry leaders who contributed opinions and input for this report, a full spectrum of views was obtained on the appropriate role of industry as a supplier or development partner for next-generation elements and systems. Reflections on the current situation, including some lingering negative perceptions of lab-industry interactions, motivated the national laboratory and industry leaders to recommend a better path forward. For those classes of optics where a compelling case can be made to rely on industry as a supplier or partner, a strategic approach within a collaborative, well-coordinated effort will go a long way toward optimizing the results.

Workshop participants noted the community's steadily increasing reliance on foreign suppliers over the past two decades. Overseas manufacturing results in U.S. industry losing the chance to develop, supply, and retain intellectual property; while U.S. scientists lose the opportunity to be first to use advanced systems in the highly competitive scientific race. It also effectively cuts off the possibility of collaboration between the DOE X-ray laboratories and industry.

### MOTIVATION FOR WORKING WITH INDUSTRY

There are a number of reasons that national laboratories would choose to partner with industry. In the most pragmatic sense, laboratories may lack the resources or facilities to produce certain optics or systems of the required quality or within a needed time frame. A partnership with industry can leverage external tools and expertise, freeing laboratory resources to devote to programmatic goals. In an era of funding challenges, the motivation of cost efficiency — from the pre-existing infrastructure to economies of scale available to industry — must be balanced with a longstanding desire for the laboratories to maintain internal capabilities, tools, and expertise. Furthermore, the laboratories' directive not to compete with industry must be considered together with the desire to support and advance U.S. domestic companies.

### CURRENT SITUATION

In attracting government-industry development partnerships, the X-ray optics community faces obstacles related to its small size, fractured organization, limited funding, and beyond-state-of-the-art requirements. Presently, leadership in the field is dispersed, and decision-making is primarily project-based and local.

In many other fields, the roles of government and industry are reversed. Large and small companies in billion-dollar industries (solar photovoltaic, biofuels, energy storage, semiconductors) partner with the national laboratories to access ideas and facilities to generate new products for the broad marketplace. In X-ray optics, however, researchers pursuing scientific and programmatic goals make incremental advances through custom and (typically) small-scale applications. In many cases, the national laboratories partner with or reach out to industry only when necessary, for highly specialized components and outcomes.

Industry representatives have reported a range of negative views of national laboratories, such as that the laboratories are difficult to work with and highly self-interested. However, some laboratory personnel have developed long-term, personal, productive, collaborative relationships with industry to develop state-of-the-art optics. For example some of the best X-ray mirrors have been fabricated by U.S. industry through multiyear collaborative efforts with national laboratories. Such productive relations can be expanded to form the basis of future lab-industry collaborations.

## A Route to a New, Vibrant Interaction with Industry

In light of these perspectives, and to understand various working models of public-private partnership, we solicited input from members of the X-ray optical community and leaders from industry. We also sought advice from the National Aeronautics and Space Administration (NASA), the Advanced Research Projects Agency-Energy (ARPA-E), and national laboratory leaders in groups and fields where public-private partnerships play a central role. Supplemented by feedback from the workshop participants, we arrived at the following observations and recommendations.

1. **Where possible, the national laboratory X-ray optics community should act collectively.** Topic by topic, leaders should be selected and working groups established to chart long-term development goals that, in their view, will be needed to meet scientific and programmatic objectives. It is helpful to regularly assess the current state of the art in each topic (as is the purpose of this broader report) and to envision intermediate steps leading to end-goal specifications that help the community meet scientific, programmatic objectives. Coordinated activities (including an effort to reduce duplication) provide critical mass and access to economies of scale beyond the means of isolated investigators.
2. **Optics needs should be clearly communicated to all relevant partners.** Within the early planning stages, consensus views about future optics needs should be communicated clearly and broadly to relevant companies through workshops and meetings in which their views and feedback can be incorporated. Companies must be able to envision and anticipate future market size and needs.
3. **Inter- and intralaboratory strategic discussions with laboratory managers should address whether fabrication projects should be performed in-house, externally, or through collaborations among multiple laboratories or individual groups.** Establishing criteria for such decision-making requires an unbiased accounting of true project costs to determine where work should take place.
4. **Working-group and industry discussions should consider whether it is beneficial to divide projects into either collaborative or separable development roles.** Where appropriate, laboratories and groups with special expertise or facilities could be recognized by the community as topical leaders and entrusted with unique development roles on behalf of the rest.
5. **Emphasize education and trust-building.** Within the context of public-private partnerships, trust and mutual benefit are guiding principles for success. National laboratories should strive to educate and train industry partners in order to better rely on their ongoing assistance. Personnel exchanges in either direction are an important way to seed technology and expertise. Where appropriate, industry representatives could be included on project and program review panels for a broader perspective.
6. **Build incentives.** Engaging companies to perform R&D for high-tech, low-volume products can be challenging when the financial rewards are limited. When creating partnership agreements or special

purchase orders, the laboratories can negotiate access to expertise, IP, and specialized facilities as incentives to cooperation. Furthermore, companies may desire access to poster sessions and meetings where they can meet potential hires, such as students and postdocs.

- 7. Reduce barriers.** Frequently cited impediments to collaboration and partnership include legal barriers and the potentially lengthy contracting process involved in Work for Others (WFO), Cooperative Research and Development Agreement (CRADA), etc. Some facility groups with numerous industrial collaborations have found ways to centralize and fast-track the contracting process, or to streamline it under blanket CRADAs that house many separate statements of work under a single approved contract. These arrangements are best suited to well-organized groups, which could further motivate interested parties at national laboratories to band together.
- 8. Identify market benefits or efficiencies.** The market may play an indirect role in furthering the goals of X-ray optics development. Where the advancement goals align well with separate, well-funded industries, development is largely paid for by others. An example can be found in the steady development of optics for EUV lithography, which have many of the same figure and roughness requirements as X-ray and synchrotron optics. Acquiring mirrors of outstanding quality is still expensive, but the development costs have largely been borne by the R&D efforts of a highly profitable industry. In cases where X-ray optics specifications push the boundaries, it makes sense to search for related fields that could benefit from advancement. There may be unrecognized market opportunities for companies in fields only tangentially related to X-ray optics. Domestic production of world-class optical systems would raise the worldwide standard in this field and incite demand from foreign markets for U.S. company products. Expanded commercial opportunities may arise in space, defense, and nanotechnology applications for products that can be created to the demanding specifications of advanced X-ray optics.
- 9. Incentivize collaboration.** Improving the internal conditions for industry collaborations within the laboratories may require a system-wide readjustment of what types of work are rewarded, improved processes for technology transfer, and a clear view of the costs of internal development. Despite encouragement to engage industry within laboratory programs, many national laboratory divisions offer little support for scientists who engage in such work. Somewhat incongruous with the high level of attention paid to work with or for commercial companies, DOE performance metrics for facilities do not currently recognize the merit of working closely with industry. For both facilities and individual scientists, time and effort dedicated to industry projects seldom results in high-profile publications and can thereby cause a net detriment to a scientist's ranking among peers. Scientists and engineers who have gone through the process of tech transfer recognize that patents and licensing can be laborious, bureaucratic, time-consuming processes, with little hope of reward in many fields. We recommend that DOE laboratories assimilate positive examples from countries in which industry interactions are promoted and encouraged within their national laboratories. Rewards could begin with recognition of the value of industry partnerships for all parties involved. In addition, the tech-transfer divisions could be more responsive, engaged, and proactive in seeking opportunities for commercialization through licensing. Finally, an accurate weighing of in-house versus external development costs for advanced components must account for the true cost of laboratory labor, in dollars and in time. Such costs can be obscured within block-grant divisions, thereby biasing judgment.
- 10. Standardize.** Part of the cost, complexity, and long lead time associated with acquiring specialized components for X-ray optics comes from the custom nature of what is required. If principal investigators can agree on a number of common components and specifications (even a subset of required gratings, mirrors, zone plates, refractive lenses, metrology tools, etc.), overall costs could be reduced by sharing or amortizing the nonrecurring engineering (NRE). There will always be cases where customization and design freedom are required for optimal outcome; yet potential cost savings from component standardization may drive the designers of future experimental systems toward the balanced goals of performance and cost.
- 11. Find funding opportunities.** One mechanism to facilitate development is through the DOE's Small Business Innovation Research (SBIR) and STTR programs. DOE funds company research through directed, topical calls for proposals. Despite the relatively small size of the initial awards, industry representatives have expressed strong support for these programs. They suggest that a successful mechanism for these programs is to form direct partnerships with laboratory scientists — initiated either by a company or laboratory staff —

to develop ideas into commercial products. In addition, SBIR directed at key segments of the optics industry would greatly help in the development of new tools and ultimately the advancement of the state of the art in manufacturing.

## Conclusions

While delivering advanced components to DOE light sources, well-organized and well-managed partnerships — among laboratories and with industry — have the potential to transform and invigorate U.S. optics-manufacturing capabilities, opening new markets and creating spillover opportunities for technologies both near and far afield. In an era of tightening budgets, the difference between minor technological improvements and major advances hinges on the ability to optimize these interactions for the benefit of all parties.

We have recommended a framework for progress that begins with coordinated, collective action among the national laboratories and branches into collaborations and partnerships that broaden knowledge, minimize redundancy, and seek economies of scale to contain costs. At the same time, we recognize that components with advanced specifications will be an expensive yet essential part of new facilities and tools. Costs should be projected as accurately as possible, including labor, optics development, and instrumentation.

We believe that DOE can spur progress toward scientific and programmatic goals through intralaboratory and public-private partnerships, and by building incentives to action into laboratory management and oversight policies. These begin with a greater recognition of the positive outcomes that can arise when the laboratories' expertise and unique facilities are brought together with U.S. manufacturing capabilities.

The path to U.S. leadership in X-ray science requires (1) collective action by the national laboratories to develop a prioritized list of advanced optics needs, (2) incentivized collaboration with U.S. domestic industry, (3) the formation of public-private partnerships, and (4) long-term planning to assure as stable a funding environment as possible.



# Agenda

## Day 1

7:30 am – 8:30 am	Registration	
8:30 am – 8:45 am	<b>Welcome, Overview and Perspectives</b>	
8:45 am – 9:15 am	<b>BES Perspectives</b> - James Murphy	<b>Session Chair</b> Denny Mills (ANL)
9:15 am – 9:45 am	<b>Spectroscopy/Inelastic Scattering of Complex Materials</b> J. Hill (BNL)	
9:45 am – 10:15 am	<b>Nano-materials Science</b> - S. Kevan (LBNL)	
10:15 am – 10:30 am	<b>Break</b>	
10:30 am – 11:00 am	<b>Activities in Europe (SXR):</b> A. Erko (HZB)	<b>Session Chair</b> Howard Padmore (LBNL)
11:00 am – 11:30 am	<b>Activities in Europe (HXR):</b> J. Susini (ESRF)	
11:30 am – 12:00 pm	<b>Activities in Asia:</b> T. Ishikawa (Spring 8)	
12:00 pm – 12:30 pm	<b>Activities in NASA:</b> B. Ramsey (NASA)	
12:30 pm – 1:30 pm	<b>Lunch</b>	
1:30 pm – 2:30 pm	<b>Nanodiffractive Optics</b> Working Group Chairs: P. Naulleau (LBNL), S. Vogt (ANL)	<b>Session Chair</b> Gene Ice (ORNL)
2:30pm – 3:30 pm	<b>Metrology</b> Working Group Chairs: V. Yashchuk (LBNL), M. Idir (BNL)	
3:30 pm – 3:45 pm	<b>Break</b>	
3:45 pm – 4:45 pm	<b>Mirrors</b> Working Group Chairs: L. Assoufid (ANL), T. Rabedeau (SLAC)	<b>Session Chair</b> Gene Ice (ORNL)
4:45 pm – 5:45 pm	<b>Thin films</b> Working Group Chairs: R. Conley (BNL), R. Soufli (LLNL)	
6:30 pm – 8:30 pm	<b>Dinner (Speaker)</b> - M. Weisskopf (NASA)	

**Day 2**

8:30 am — 9:30 am	<b>Crystal Optics</b> Working Group Chairs: T. Toellner (ANL), P. Siddons (BNL)	<b>Session Chair</b> Peter Eng (UC)
9:30 am — 10:30 am	<b>Refractive Optics</b> Working Group Chairs: K. Evans-Lutterodt (BNL), A. Sandy (ANL)	
10:30 am — 10:45 am	<b>Break</b>	
10:45 am — 11:45 am	<b>Simulation and Modeling</b> Working Group Chairs: O. Chubar (BNL), J. Krzywinski (SLAC)	
11:45 am — 12:45 pm	<b>Adaptive Optics</b> Working Group Chairs: L. Poyneer (LLNL), N. Kelez (SLAC)	
12:45 pm — 1:45 pm	<b>Lunch</b>	
1:45 pm — 2:45 pm	<b>Grating Optics</b> Working Group Chairs: D. Cocco (SLAC), T. Warwick (LBNL)	<b>Session Chair</b> Stefan Hau-Riege (LLNL)
2:45 pm — 3:45 pm	<b>Interactions with Industry</b> Working Group Chairs: K. Goldberg (LBNL), A. Khounsary (ANL)	
3:45 pm — 4:45 pm	<b>Models for Optics Facility Operation and R&amp;D</b> Working Group Chairs: M. Pivovarov (LLNL), J. Arthur (SLAC)	
4:45 pm — 5:00 pm	<b>Break</b>	
5:00 pm — 6:00 pm	Focus group breakout sessions and report writing	

**Day 3**

8:30 am — 10:30 am	Focus group breakout sessions and report writing	
10:30 am — 10:45 am	<b>Break</b>	
10:45 am — 12:00 pm	Working Group updates	Denny Mills Howard Padmore
12:00 pm — 12:15 pm	Next steps and closeout	Denny Mills Howard Padmore
12:15 pm	Adjourn	

# Attendees

Arthur, John, SLAC

Assoufid, Lahsen, ANL

Bajuk, Dan, Zygo

Cerrone, Linda, DOE

Chu, Yong, BNL

Chubar, Oleg, BNL

Cocco, Daniele, SLAC

Conley, Ray, BNL

Eng, Peter, U. Chicago CARS

Erko, Alexei, Helmholtz

Evans-Lutterodt, Ken, BNL

Falcone, Roger, University of California

Feser, Michael, Xradia, Inc.

Goldberg, Ken, LBNL

Griesmann, Ulf, NIST

Hau-Riege, Stefan, LLNL

Heilmann, Ralf, MIT

Hill, John, BNL

Ice, Gene, ORNL

Idir, Mourad, BNL

Ishikawa, Tetsuya, Spring 8

Kelez, Nicholas, SLAC

Kevan, Stephen, LBNL

Khounsary, Ali, ANL

Kirz, Janos, SBU/LBNL

Krause, Jeff, DOE

Kraushaar, Phil, DOE

Krzywinski, Jacek, SLAC

Kung, Harriet, DOE

Lee, Peter, DOE

Lessner, Eliane, DOE

Mills, Denny, ANL

Murphy, James, DOE

Naulleau, Patrick, LBNL

Nguyen, Van, DOE

Padmore, Howard, LBNL

Pivovarov, Michael, LLNL

Platanov, Yuri, Rigaku

Poyneer, Lisa, LLNL

Rabedeau, Tom, SLAC

Ramsey, Brian, NASA MSFC

Rhyne, James, DOE

Robichaud, Joseph, L-3 Communications

Sandy, Alec, ANL

Shapiro, David, LBNL

Siddons, Peter, BNL

Smith, Douglas, Plymouth Grating Laboratory

Soufli, Regina, LLNL

Susini, Jean, ESRF

Tabeling, Joe, Delaware Diamond Knife

Tessema, Guebre, NSF

Toellner, Tom, ANL

Tonnessen, Tom InSync

Tricard, Marc, Zygo Corporation

Vogt, Stefan, ANL

Warwick, Tony, LBNL

Webb, Sam, SSRL

Weisskopf, Martin, NASA

Williams, Garth, LCLS

Wilson, Lane, DOE

Yashchuk, Valeriy, LBNL

# Glossary

AFM	atomic force microscopy	KB	Kirkpatrick-Baez
ALS	Advanced Light Source	KL	kinoform lens
AO	adaptive optics	LCLS	Linac Coherent Light Source
APS	Advanced Photon Source	LTP	long trace profiler
ARPA-E	Advanced Research Projects Agency-Energy	MLL	multilayer Laue lens
BES	Basic Energy Sciences	MTF	modulation transfer function
BPRA	binary pseudorandom array	MX	macromolecular crystallography
CCD	charge-coupled device	NASA	National Aeronautics and Space Administration
CHX	Coherent Hard X-ray	NOM	Nano-Optic-Measuring machine
CMP	chemical-mechanical polishing	NRE	nonrecurring engineering
CNM	Center for Nanoscale Materials	NRS	nuclear resonant spectroscopy
CRADA	Cooperative Research and Development Agreement	NSLS	National Synchrotron Light Source
CRL	compound refractive lens	PSD	power spectral density
CVD	chemical vapor deposition	RIXS	resonant inelastic X-ray scattering
CXRO	Center for X-ray Optics	rms	root mean square
DOE	Department of Energy	SASE	self-amplified stimulated emission
DRIE	deep reactive-ion etching	SAXS	small-angle X-ray scattering
DWOL	direct-write optical lithography	SBIR	Small Business Innovation Research
EBL	electron beam lithography	SEM	scanning electron microscopy
EEM	elastic-emission machining	SOFC	solid-oxide fuel cell
ERL	energy recovery linac	SR	synchrotron radiation
ESRF	European Synchrotron Radiation Facility	STTR	Small Business Technology Transfer
EUV	extreme ultraviolet	SXR	soft X-ray
FEL	free electron laser	TEM	transmission electron microscopy
FFT	Fast Fourier Transform	VSB	variable-shaped beam
FIB	focused ion beam	VUV	vacuum ultraviolet
FOM	figure of merit	WFO	Work for Others
FWHM	full width half maximum	XES	X-ray emission spectroscopy
HEDM	high-energy diffraction microscopy	XFEL	X-ray free electron laser
HMLM	high-heat-load monochromator	XPCS	X-ray photon correlation spectroscopy
HZB	Helmholz-Zentrum Berlin	XRS	X-ray Raman spectroscopy
IBF	ion beam figuring/finishing	YSZ	yttria-stabilized zirconia
IXS	inelastic X-ray scattering	ZP	zone plate



