

Next Generation Photon Sources for Grand Challenges in Science and Energy

A REPORT OF A SUBCOMMITTEE TO THE BASIC ENERGY SCIENCES
ADVISORY COMMITTEE | MAY 2009

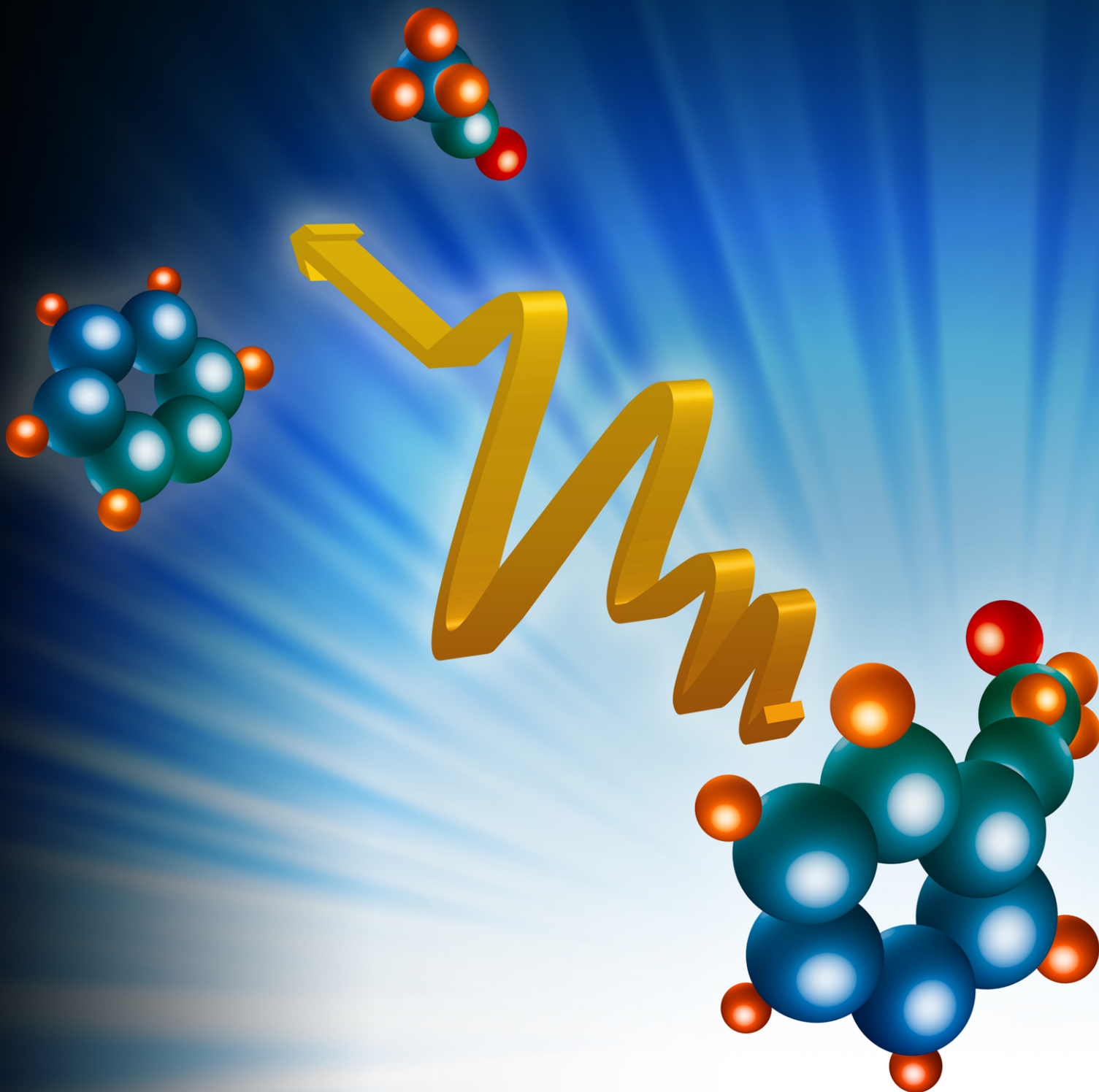

On the Cover:

Laser pulses can be shaped or tailored in order to control the pathway of a photochemical reaction. For example, different dissociation products can be produced from a given molecule, depending on the temporal and spectral shape of the laser pulse. Fourth generation X-ray light sources can reveal the structure and electronic energies of the intermediate and final states during the course of the photochemical reaction by interrogation with an X-ray pulse, correlated in time with the laser pulse driving the reaction.

Next-Generation Photon Sources for Grand Challenges in Science and Energy

Report of the Workshop on Solving Science and Energy Grand Challenges with Next-Generation Photon Sources

**October 27-28, 2008
Rockville, Maryland**

Co-Chairs

Wolfgang Eberhardt
Helmholtz Center, Berlin
and

Franz Himpfel
University of Wisconsin - Madison

Discussion Leaders

Nora Berrah (Western Michigan)
Gordon Brown (Stanford)
Hermann Dürr (Berlin)
Russell Hemley (Carnegie Institution, D.C.)
John C. Hemminger (Irvine)
Janos Kirz (Berkeley)
Rick Osgood (Columbia)
Julia Phillips (Sandia)
Robert Schlögl (Berlin)
Z.X. Shen (Stanford)

Scientific Editors

Simon Bare (UOP LLC)
Michelle Buchanan (Oak Ridge)
George Crabtree (Argonne)
Wolfgang Eberhardt (Berlin)
Franz Himpfel (Wisconsin)
Marc Kastner (MIT)
Michael Norman (Argonne)
John Sarrao (Los Alamos)

A Report of the Basic Energy Sciences Advisory Committee

Chair:

John C. Hemminger
University of California - Irvine

**Prepared by the BESAC Subcommittee on
Facing Our Energy Challenges in a New Era of Science**

Co-chairs:

George Crabtree
Argonne National Laboratory
and
Marc Kastner
Massachusetts Institute of Technology

U.S. Department of Energy
May 2009

Basic Energy Sciences Advisory Committee

Chair:

John C. Hemminger (University of California-Irvine)

Simon Bare (UOP LLC)

Nora Berrah (Western Michigan University)

Sylvia Ceyer (Massachusetts Institute of Technology)

Sue Clark (Washington State University)

Peter Cummings (Vanderbilt University)

Frank DiSalvo (Cornell University)

Mostafa El-Sayed (Georgia Institute of Technology)

George Flynn (Columbia University)

Bruce Gates (University of California-Davis)

Laura Greene (University of Illinois at Urbana-Champaign)

Sharon Hammes-Schiffer (Pennsylvania State University)

Michael Hochella (Virginia Polytechnic Institute)

Bruce Kay (Pacific Northwest National Laboratory)

Kate Kirby (Smithsonian Center for Astrophysics)

William McCurdy, Jr. (University of California-Davis)

Daniel Morse (University of California-Santa Barbara)

Martin Moskovits (University of California-Santa Barbara)

Kathryn Nagy (University of Illinois at Chicago)

John Richards (California Institute of Technology)

John Spence (Arizona State University)

Kathleen Taylor (General Motors, retired)

Douglas Tobias (University of California-Irvine)

John Tranquada (Brookhaven National Laboratory)

Designated Federal Officer:

Harriet Kung

Associate Director of Science for Basic Energy Sciences

Subcommittee on Facing our Energy Challenges in a New Era of Science

Co-chairs:

George Crabtree (Argonne National Laboratory)

Marc Kastner (Massachusetts Institute of Technology)

Simon Bare (UOP LLC)*

Michelle Buchanan (Oak Ridge National Laboratory)

Andrea Cavalleri (Oxford University, UK)

Yet-Ming Chiang (Massachusetts Institute of Technology)

Sue Clark (Washington State University)*

Don DePaolo (Lawrence Berkeley National Laboratory)

Frank DiSalvo (Cornell University)*

Wolfgang Eberhardt (BESSY-Berlin)

John C. Hemminger (*ex officio*, University of California-Irvine)**

Wayne Hendrickson (Columbia University)

Franz Himpsel (University of Wisconsin-Madison)

Michael Klein (University of Pennsylvania)

Carl Lineberger (University of Colorado)

Patrick Looney (Brookhaven National Laboratory)

Thomas Mallouk (Pennsylvania State University)

Michael Norman (Argonne National Laboratory)

Arthur Nozik (National Renewable Energy Laboratory)

Julia Phillips (Sandia National Laboratories)

John Sarrao (Los Alamos National Laboratory)

Technical Support:

Michael Casassa (Basic Energy Sciences)

Jim Horwitz (Basic Energy Sciences)

Roger Klaffky (Basic Energy Sciences)

* *BESAC Member*

** *BESAC Chair*

TABLE OF CONTENTS

Notations	iii
1. Executive Summary	1
2. Introduction	3
3. Photon Science Drivers	13
4. Cross-Cutting Challenges	31
5. Conclusion	45
Appendix 1: Photon Sources	47
Appendix 2: New Scientific Opportunities	67
Appendix 3: Related Studies	109
Appendix 4: Photon Workshop Charge	111
Appendix 5: Photon Workshop Agenda	113
Appendix 6: Photon Workshop Participants	117

NOTATION

ARPES	angle-resolved photoemission spectroscopy
ASISI	Argonne Scattering, Imaging and Spectroscopy Institute
BES	Basic Energy Sciences
BESAC	Basic Energy Sciences Advisory Committee
BNL	Brookhaven National Laboratory
BRN	Basic Research Needs
CGH	computer-generated hologram
CW	continuous wave (also cw)
DNA	deoxyribonucleic acid
DOE	U.S. Department of Energy
EOS	equation of state
ERL	energy recovery LINAC
ESFRI	European Strategy Forum on Research Infrastructures
EUV	extreme ultraviolet
EXAFS	extended X-ray absorption fine structure
FEL	free electron laser
GIXD	grazing-incidence x-ray diffraction
HGHG	high gain harmonic generation
HHG	high harmonic generation
ICF	inertial confinement fusion
ID	insertion device
IR	infrared
IXS	inelastic X-ray scattering
LCLS	LINAC Coherent Light Source
LINAC	linear accelerator
MAD	multiwavelength anomalous dispersion
MCD	magnetic circular dichroism
MEG	multiple exciton generation
NEXAFS	near-edge X-ray absorption fine structure
NSLS	National Synchrotron Light Source
NSRC	Nanoscale Science Research Center
PCM	phase-change memory
PDF	pair distribution function
PEEM	photoemission electron microscopy
PES	photoemission
P-T	pressure-temperature

QD	quantum dot
R&D	research and development
RF	radion frequency
RIXS	resonant inelastic X-ray scattering
SASE	self-amplified spontaneous emission
SAXS	small-angle X-ray scattering
SCSS	SPring-8 Compact SASE Source
SEM	scanning electron microscopy
SPES	scanning photoelectron spectromicroscopy
SPP	surface plasmon polariton
STFC	Science and Technology Facilities Council
STXM	scanning transmission X-ray microscopy
TIPS	Theory Institute for Photon Sciences
UCLA	University of California at Los Angeles
UV	ultraviolet
VUV	vacuum ultraviolet
WAXS	wide-angle X-ray scattering
WDM	warm dense matter
XANES	X-ray absorption near edge structure
XAS	X-ray absorption spectroscopy
XES	X-ray emission spectroscopy
XPCS	X-ray photon correlation spectroscopy
XPS	X-ray photoemission spectroscopy
XRD	X-ray diffraction
2-D	two-dimensional
3-D	three-dimensional

Units of Measurement

as	attosecond
eV	electron volt
fs	femtosecond
Gbar	gigabar
K	Kelvin
keV	kiloelectron volt
Mbar	megabar
meV	millielectron volt
nm	nanometer
ps	picosecond
s	second
THz	terahertz

1. EXECUTIVE SUMMARY

The next generation of sustainable energy technologies will revolve around transformational new materials and chemical processes that convert energy efficiently among photons, electrons, and chemical bonds. New materials that tap sunlight, store electricity, or make fuel from splitting water or recycling carbon dioxide will need to be much smarter and more functional than today's commodity-based energy materials. To control and catalyze chemical reactions or to convert a solar photon to an electron requires coordination of multiple steps, each carried out by customized materials and interfaces with designed nanoscale structures. Such advanced materials are not found in nature the way we find fossil fuels; they must be designed and fabricated to exacting standards, using principles revealed by basic science. Success in this endeavor requires probing, and ultimately controlling, the interactions among photons, electrons, and chemical bonds on their natural length and time scales.

Control science—the application of knowledge at the frontier of science to control phenomena and create new functionality—realized through the next generation of ultraviolet and X-ray photon sources, has the potential to be transformational for the life sciences and information technology, as well as for sustainable energy. Current synchrotron-based light sources have revolutionized macromolecular crystallography. The insights thus obtained are largely in the domain of static structure. The opportunity is for next-generation light sources to extend these insights to the control of dynamic phenomena through ultrafast pump-probe experiments, time-resolved coherent imaging, and high-resolution spectroscopic imaging. Similarly, control of spin and charge degrees of freedom in complex functional materials has the potential not only to reveal the fundamental mechanisms of high-temperature superconductivity, but also to lay the foundation for future generations of information science.

This report identifies two aspects of energy science in which next-generation ultraviolet and X-ray light sources will have the deepest and broadest impact:

- The temporal evolution of electrons, spins, atoms, and chemical reactions, down to the femtosecond time scale.
- Spectroscopic and structural imaging of nano objects (or nanoscale regions of inhomogeneous materials) with nanometer spatial resolution and ultimate spectral resolution.

The dual advances of temporal and spatial resolution promised by fourth-generation light sources ideally match the challenges of control science. Femtosecond time resolution has opened completely new territory where atomic motion can be followed in real time and electronic excitations and decay processes can be followed over time. Coherent imaging with short-wavelength radiation will make it possible to access the nanometer length scale, where intrinsic quantum behavior becomes dominant. Performing spectroscopy on individual nanometer-scale objects rather than on conglomerates will eliminate the blurring of the energy levels induced by particle size and shape distributions and reveal the energetics of single functional units. Energy resolution limited only by the uncertainty relation is enabled by these advances.

Current storage-ring-based light sources and their incremental enhancements cannot meet the need for femtosecond time resolution, nanometer spatial resolution, intrinsic energy resolution, full coherence over energy ranges up to hard X-rays, and peak brilliance required to enable the new science outlined in this report. In fact, the new, unexplored territory is so expansive that no single currently imagined light source technology can fulfill the whole potential. Both technological and economic challenges require resolution as we move forward. For example, femtosecond time resolution and high peak brilliance are required for

following chemical reactions in real time, but lower peak brilliance and high repetition rate are needed to avoid radiation damage in high-resolution spatial imaging and to avoid space-charge broadening in photoelectron spectroscopy and microscopy.

But light sources alone are not enough. The photons produced by next-generation light sources must be measured by state-of-the-art experiments installed at fully equipped end stations. Sophisticated detectors with unprecedented spatial, temporal, and spectral resolution must be designed and created. The theory of ultrafast phenomena that have never before been observed must be developed and implemented. Enormous data sets of diffracted signals in reciprocal space and across wide energy ranges must be collected and analyzed in real time so that they can guide the ongoing experiments. These experimental challenges—end stations, detectors, sophisticated experiments, theory, and data handling—must be planned and provided for as part of the photon source. Furthermore, the materials and chemical processes to be studied, often *in situ*, must be synthesized and developed with equal care. These are the primary factors determining the scientific and technological return on the photon source investment.

Of equal or greater concern is the need for interdisciplinary platforms to solve the grand challenges of sustainable energy, climate change, information technology, biological complexity, and medicine. No longer are these challenges confined to one measurement or one scientific discipline. Fundamental problems in correlated electron materials, where charge, spin, and lattice modes interact strongly, require experiments in electron, neutron, and X-ray scattering that must be coordinated across platforms and user facilities and that integrate synthesis and theory as well. The model of users applying for one-time access to single-user facilities does not promote the coordinated, interdisciplinary approach needed to solve today's grand challenge problems. Next-generation light sources and other user facilities must learn to accommodate the interdisciplinary, cross-platform needs of modern grand challenge science. Only through the development of such future sources, appropriately integrated with advanced end stations and detectors and closely coupled with broader synthesis, measurement, theory, and modeling tools, can we meet the demands of a New Era of Science.

2. INTRODUCTION

1. THE SCIENTIFIC CHALLENGES OF ENERGY SCIENCE AND THE PROMISE OF CONTROL SCIENCE

Meeting our future energy needs sustainably and securely is one of our most difficult societal challenges [1]. The next generation of sustainable energy technologies will revolve around transformational new materials and chemical processes that convert energy efficiently among photons, electrons, and chemical bonds. New materials that tap sunlight, store electricity, or make fuel from splitting water or recycling carbon dioxide will need to be much smarter and more functional than today's commodity-based energy materials. To control and catalyze chemical reactions or to convert a solar photon to an electron requires coordination of multiple steps, each carried out by customized materials and interfaces with designed nanoscale structures. Such advanced materials are not found in nature the way we find fossil fuels; they must be designed and fabricated to exacting standards, using principles revealed by basic science. Probing, and ultimately controlling, the interactions among photons, electrons, and chemical bonds on their natural length and time scales requires next-generation light sources.

The task of creating materials with novel advanced properties and behaviors is enormously empowered by a transformation now occurring in science: the rise of "control science" from observational science. The 20th century witnessed revolutionary advances in observational science, allowing us to observe structure and dynamics on ever decreasing length and time scales with ever increasing precision and detail. Photon sources with energies that span the infrared to the ultraviolet and X-ray domains have played an essential role in this progress. In parallel with these advanced observational capabilities, we have made remarkable materials discoveries, such as high-temperature superconductors that enable high-capacity electricity transmission, and carbon nanotubes that combine the strength of steel with the mass of a feather. The confluence of advanced observational tools and accelerated materials discovery foreshadows a new era of science.

Control science takes observational science one step farther, mastering the complexity of materials and chemical change and replacing serendipity with intention. The accumulated knowledge derived from observations allows us to design, initiate, and direct the chemical and physical behavior of materials at atomic and nanoscales. We are on the verge of being able to intentionally design, as well as serendipitously discover, complex materials and chemical processes to carry out specific functions. The intersection of control science with energy challenges creates a tipping point for sustainable energy. Creating the transformational new materials and chemical processes for next-generation sustainable energy technologies will require a new generation of photon sources with capabilities not previously imagined. This report identifies the phenomena and processes that must be harnessed, and the attributes of the photons required, to meet this challenge with temporal and spatial resolution and spectral characteristics far beyond current capability.

To envision this next generation of control of complex materials and chemical phenomena, imagine "movies" of complex chemical reactions that show the chemical bonds of the reactants breaking and reforming on their natural time scales as they create a sequence of intermediate states, some with catalyst molecules, and finally producing stable end products. Such movies may be within reach using images from next-generation light sources. Then imagine using photons from these same light sources to coherently control the course of chemical reactions, in analogy with the precise sequence of light-induced oxidation and reduction reactions that occur in photosynthesis. Similarly, imagine a dynamic nanoscale landscape of electrons, spins, and atomic assemblies, and orchestrating these intrinsically quantum phenomena with a sequence of precisely designed light pulses to generate revolutionary functionality. The ability to access the natural temporal and spatial scales on which complex materials and chemical

processes “work” is presently beyond our reach, but it begins to emerge with the next generation of photon sources.

The full potential of control science, if realized through next-generation ultraviolet and X-ray photon sources, would be transformational for the life sciences and information technology, as well as for sustainable energy. Current synchrotron-based light sources have revolutionized macromolecular crystallography. The insights thus obtained are largely in the domain of static structure. The opportunity is for next-generation light sources to extend these insights to the control of dynamic phenomena through ultrafast pump-probe experiments and time-resolved coherent imaging. Similarly, control of spin and charge degrees of freedom in complex functional materials has the potential not only to reveal the fundamental mechanisms of high-temperature superconductivity but also to lay the foundation for future generations of information science.

From the outset, it is important to note that meeting the challenges discussed above requires additional sources of photons at lower energies, in the infrared (IR) and terahertz (THz) domains. Photons of these energies can directly probe the vibrational spectra of relevant molecules and solids, while longer-wavelength excitations can selectively stimulate reaction pathways. Furthermore, additional materials synthesis and measurement tools beyond photons are needed. In fact, the need to integrate these capabilities with next-generation ultraviolet and X-ray photon sources is a central conclusion of this report. A detailed analysis of these needs, however, is beyond the scope of this report. The focus here is on new science that can be done by photons in the soft and hard X-ray domains with shorter pulse lengths, higher average and peak brightness, and greater coherence.

2. X-RAY SCIENCE AND THE STUDY OF MATTER IN THE 20TH CENTURY

For many decades, X-ray tubes like those now used to make medical X-rays were at the leading edge of materials research. Even before the advent of dedicated synchrotron radiation sources in the early 1970s the application of X-rays in the study of materials had not only revolutionized our knowledge of matter on the fundamental level of atoms, electrons, and spins but also redefined entire fields of physics, chemistry, biology, and medicine by revealing previously unseen atomic order in solids, the nature of chemical bonds, the cellular structure of living things, and the organs, muscles, and bones inside the human body. The transformations enabled by laboratory-scale sources were profound and inspired the development of larger-scale user facilities.

There have now been three generations of synchrotron-based ultraviolet and X-ray light sources. With each light source generation, new performance parameters (labeled “photon attributes” in this study) have emerged. Typically, the performance of these light sources has improved by about four orders of magnitude from one generation to the next, leading to qualitatively new capabilities and to an enormous growth in the user community. The first generation operated in a parasitic mode at synchrotrons built for high-energy physics, with highly variable beam intensity. The second generation saw dedicated storage rings with stable beam currents and a photon flux that was four orders of magnitude higher. The third generation conditioned the electron beam with magnetic insertion devices to produce unprecedented spectral brilliance, which allowed spectroscopy with high energy resolution and microscopy and crystallography with high spatial resolution.

Currently, there are more than eight thousand annual users at the four U.S. Department of Energy (DOE) light sources performing state-of-the-art experiments. Their efforts have resulted in new and groundbreaking science that is changing our understanding of many research fields. Such facilities have provided the basis for the high-throughput determination of the structures of proteins by X-ray crystallography, without which modern molecular biology would not exist. Hard X-rays with energies from about 3 keV to 100 keV image complex structures on sub-nanometer length scales. Soft X-rays with

energies from about 10 eV to 3 keV probe the electronic structure of matter using near-edge X-ray absorption fine structure (NEXAFS), X-ray emission spectroscopy (XES), and photoemission spectroscopy (PES). These hard and soft X-ray tools are routinely used at synchrotron facilities today in forefront research in materials science, chemistry, biology, and atomic and molecular physics. To date, nineteen Nobel Prizes have been awarded for X-ray science, four of which were linked to work done at synchrotron sources.

We are presently on the brink of a fourth generation of ultraviolet and X-ray light sources. These sources will bring two new capabilities, femtosecond time resolution and laser-like coherence, along with many-orders-of-magnitude increases in peak and average brilliance. Given the magnitude of the opportunity, a number of recent studies have investigated the prospects and potential for fourth-generation ultraviolet and X-ray light sources (see the references in Appendix 3 for a partial list). This report builds on these prior studies by emphasizing the currently unfulfilled needs in controlling complex materials and chemical processes that are central to meeting our energy challenges.

3. X-RAYS AND ENERGY SCIENCE IN THE 21ST CENTURY

The scientific problems we must solve to address challenges in sustainable energy, information technology, and biomedicine involve the valence orbitals of atoms, the band gaps of semiconductors, and the chemical bonds of molecules, all with energies of electron volts, approximately the energy of a photon of visible or ultraviolet light. Soft and hard X-rays carry much greater energies, up to 100 keV. Remarkably, the relatively high energy of soft and hard X-rays is not only useful but also essential for probing the low-energy electronic and bonding states in molecules and materials.

High-energy X-rays are required to probe the atomic structure of molecules and materials, where atoms typically are separated by a few tenths of nanometers. To image these tiny distances and to diffract from atomic lattices with this spacing requires hard X-rays with comparable wavelengths. A second use of high-energy photons is chemical selectivity. The atoms and ions that make up molecules and materials are distinguishable by the excitation spectra of their core electrons, typically with energies of less than 1 kiloelectron volts to 100 keV. The core excitation spectra not only identify the targeted atomic species, but also contain fine structure, obtained via extended X-ray absorption fine structure (EXAFS) and NEXAFS, that is a fingerprint of the surrounding atomic arrangements. Penetrating power is a third important feature; *in situ* experiments often must scatter X-rays from target structures surrounded by gaseous or liquid environments, contained in pressure vessels, or buried in the interior of a solid. High-energy X-rays are essential for this. A fourth important probe is the energy lost by X-rays inelastically scattered from materials and molecules. Energy loss spectra, measured to a fraction of an electron volt, interrogate subtle features of electronic structure, correlation, and bonding, even if the incoming energy of the X-ray is hundreds or thousands of electron volts. Pump-probe experiments enable a fifth use of soft and hard X-rays. An external pump, such as a short pulse of visible light from a laser, excites the valence or bonding electrons, while an X-ray pulse following the pump excitation by a synchronized delay time interrogates the structure or energy of the system as it relaxes to its equilibrium state or transitions to a new state.

This report identifies two aspects of energy science in which next-generation ultraviolet and X-ray light sources will have the deepest and broadest impact:

- The temporal evolution of electrons, spins, atoms, and chemical reactions, down to the femtosecond time scale.

- Spectroscopic and structural imaging of nano objects (or nanoscale regions of inhomogeneous materials) with nanometer spatial resolution and ultimate spectral resolution.

The techniques required to achieve temporal resolution on the femtosecond scale have been pioneered using tabletop optical laser sources. Pump-probe methods have progressed in response to the rapid evolution of ever more powerful infrared and visible-light lasers, which have played the role of either pump or probe in different experiments. Laser pulses have grown ever shorter, down to the vicinity of femtoseconds, where the duration of the pulse is comparable to the period of a molecular vibration. The potential combination of these optical laser pulses with similarly short, intense pulses of X-rays has inspired the dream of entirely new classes of experiments that will probe the motion of atoms in molecules and solids on their own time scale.

The technique of high harmonic generation (HHG) produces femtosecond to attosecond pulses of extreme ultraviolet or shorter wavelength light triggered by short optical laser pulses. These pulses are orders of magnitude less intense than synchrotron radiation, but they are allowing the first efforts to probe the correlated motion of electrons on their own time scale. It is these new techniques and pioneering early experiments at ultrashort time scales that have fueled the momentum for developing X-ray sources that reach these same time scales with intensities that exceed that of the third-generation light sources by orders of magnitude. Such capability would open up new frontiers of discovery.

Complementing the drive for ever shorter time scales is a similar push for imaging at ever higher spectral resolution, revealing bond orbitals in molecules and electron energy levels in solids. The development of coherent sources enables ultimate spectroscopic imaging with diffraction-limited spatial resolution. Even higher spatial resolution can be achieved by imaging the photoelectrons, which can be accelerated to have much smaller wavelengths than the photons themselves. Coherence of the incident beam allows the phase information of the diffracted signal to be recovered, enabling the reconstruction of the real space object by inverse Fourier transform of the diffracted signals, without the need for focusing X-ray optics. With no degradation of the image by imperfect X-ray optics, this kind of diffractive or lensless imaging has the potential to achieve diffraction-limited resolution in three dimensions, provided the degree of coherence of the incident beam is sufficiently high. For non-symmetrical objects, coherent diffractive imaging opens broad new horizons for structure determination and visualization that were unthinkable only ten years ago. Combined with high peak brilliance and femtosecond pulses, diffractive imaging enables the time evolution of dynamic structures to be captured. These advances are especially valuable for *in situ* studies of complex functional materials in realistic environments, such as a catalytic reactor or a fuel cell, where not only the material but also the environment is inhomogeneous on the nanoscale. Imagine the potential of chemically imaging a single active catalytic or charge storage site in an operating fuel cell or advanced battery. The primary feature enabling this breakthrough is the coherence of next-generation X-ray sources.

Spatial resolution on the nanoscale, enabled by coherent sources, will advance not only the frontiers of imaging but also spectroscopic resolution. The ability to illuminate individual nanometer-scale objects eliminates the blurring of the energy levels by particle size, shape, orientation, and defect distributions and reveals the energetics of single functional units rather than ensemble averages. Imagine resolving the attractive interactions between electrons in a high-Tc superconductor with sufficient spatial and energy resolution to differentiate various coupling mechanisms.

One of the most remarkable and promising opportunities of next-generation light sources is the combination of high peak brilliance, short pulses, and diffractive imaging that has the potential to capture structural images without radiation damage from the intense photon beam. The key feature is very different time scales: the image is collected on the scale of the pulse length, while structural damage

occurs on the scale of atomic motion and vibrational frequencies. With sufficiently high photon intensity and short pulse length, complete phase-coherent images and spectroscopic information can be acquired on time scales faster than the damage occurs. As with the promise of temporal resolution on the femtosecond scale, the promise of nanoscale spatial resolution enabled by lensless imaging with coherent sources motivates the excitement about next-generation sources.

The dual advances of temporal and spatial resolution promised by fourth-generation light sources ideally match the challenges of control science. Femtosecond time resolution opens completely new territory, where atomic motion can be followed in real time and the energy of electronic excitations can be resolved limited only by the uncertainty principle. Coherent imaging will make it possible to access the nanometer length scale, where intrinsic quantum behavior becomes dominant. Performing spectroscopy on individual nanometer-scale objects rather than on conglomerates will eliminate the blurring of the energy levels induced by particle size and shape distributions and reveal the energetics of single functional units. Energy resolution limited only by the uncertainty relation is enabled by these advances.

Beyond previously unrealized spatial and temporal resolution, the orders-of-magnitude advances in source intensity of next-generation light sources enable whole classes of measurements that present-generation sources are too weak to pursue. *In situ* measurements of materials responding to extreme environments, such as high pressure and temperature, reactive chemicals, and high radiation doses, allow capturing the atomic and molecular dynamics of chemical and structural phase transformations as they take place. Imaging critical components of devices operating in their intended environments enables insights into performance limitations and failure modes. Observing the influence of synthesis parameters like temperature, pressure, and chemical environment on the growth of crystals and films and the self-assembly of macromolecules allows the refinement and development of entirely new synthesis techniques for complex materials. Such temporally and spatially resolved *in situ* measurements are only possible with qualitative advances in source intensity.

One simple example that embodies the excitement of next-generation sources is the observation and control of chemical and biochemical reactions in real time. Complex reactions typically comprise many elementary steps, including bond making and breaking with catalysts and the formation of intermediate chemical species before the final products are created. Most of these steps remain hidden from observation because their space and time scales are beyond the resolution of existing X-ray experiments and the number of photons scattered from the reacting molecules is too small to detect. Next-generation light sources, with several orders of magnitude higher peak brightness, femtosecond time structure, and coherent beams that enable nanometer-scale diffractive imaging, will bring characterization of the elementary steps of chemical reactions within reach.

The coherence of next-generation sources enables an intriguing new probe of the statistical behavior of complex systems composed of many subassemblies. A polycrystal composed of many grains and exposed to coherent X-rays, for example, produces a speckle pattern that distinguishes the image of each grain and contains information on grain size and orientation. Instead of the average signal from all grains produced by incoherent light, coherent illumination gives a separate image, or speckle, for each grain. With short pulses and high peak intensity, the time-resolved dynamic response of each individual component of a composite system could be followed. The statistical behavior of nanocomposite materials, the response of magnetic domains to a changing field, and the reaction of bacteria cultures to external stimuli are examples of coherently diffracted speckle patterns tracking dynamic statistical behavior.

Current storage-ring-based light sources and their incremental enhancements cannot meet the need for femtosecond time resolution, nanometer spatial resolution, full coherence over energy ranges up to hard X-rays, and peak brilliance required to enable the new science outlined in this report. In fact, the new, unexplored territory is so expansive that no currently imagined light source technology can fulfill the

whole potential. Femtosecond time resolution and high peak brilliance are required for following chemical reactions in real time, for example, but lower peak brilliance and high repetition rate are needed to avoid radiation damage in high-resolution spatial imaging and to avoid space-charge broadening in photoelectron spectroscopy and microscopy. In the following chapters, we discuss a wide range of specific energy challenges and the photon attributes required to meet them.

4. THE WORLDWIDE LANDSCAPE FOR ENTIRELY NEW CLASSES OF X-RAY FACILITIES

Advances in particle accelerators, lasers, and superconductivity have led to the development of technologies that are making possible the construction of entirely new classes of light sources. Essential aspects of the technology that underpin proposals for energy recovery linacs (ERLs), free electron lasers (FELs), and “ultimate” storage rings are described in Appendix 1, as well as opportunities with such high harmonic laboratory-scale sources as high harmonic generation lasers. Both technology and economic drivers prevent the full achievement of desired capabilities. For example, the ability to produce and transport the required high electron bunch charges at very high brightness and high repetition rates does not exist. These and similar issues could improve in the face of targeted research and development over the next few years. It is also clear that directed research and development would be able to substantially reduce the building and operating costs and improve the performance of the desired multi-gigaelectron-volt superconducting accelerators.

An international debate on these technologies and how best to develop and deploy them is now under way, marked by workshops and detailed proposals for this new generation of light sources as outlined in Appendix 3. A few frontier facilities, like the LINAC Coherent Light Source (LCLS), which operates primarily in the hard X-ray regime; FLASH, which thus far operates at soft X-ray energies; and the SPring-8 Compact SASE Source (SCSS) have been completed or are under construction. It is notable that only one project, LCLS, is funded for construction in the United States and that there is a wide variation in the capabilities of the light sources under consideration.

To understand how scientific needs are driving the development of these technologies, we note below their differences from today’s storage rings:

- (1) Fourth-generation light sources will provide orders of magnitude more brightness than those of the third generation—enabling, among other important advances, the ability to image the electronic structure of materials at the nanoscale.
- (2) Fourth-generation light sources will provide time resolution never before achieved in combination with the brightness of these new, intense sources of X-rays. They will produce pulses with durations of hundreds of femtoseconds (10^{-15} s) down to ultrashort pulses of a few femtoseconds or even a few hundred attoseconds (10^{-18} s).
- (3) Fourth-generation light sources will provide laser-like coherence, far greater and at far higher energies than today’s X-ray light sources.

5. THE WORKSHOP THAT PRODUCED THIS REPORT

Under the auspices of the “New Era” Subcommittee of the Basic Energy Sciences Advisory Committee (BESAC), a workshop was held in October 2008, with over 100 invited participants from around the globe representing diverse areas of energy-related science. Participants were selected for their scientific leadership and broad knowledge of energy-related areas of science, as well as their knowledge of synchrotron light sources. This created an environment in which both future energy challenges and future

light source capabilities could be discussed on equal footing. The workshop's central purpose was to identify the photon attributes needed to meet the scientific challenges in a diverse array of energy-related fields, without consideration for particular architectures or designs that might be the source of these photons.

The principal work of the workshop was carried out by the participants in ten discussion groups. The topical areas for these groups are indicated below, with their leaders:

- | | |
|--|---|
| 1. Nanoscale Electrons and Spins | Hermann Dürr (Berlin) |
| 2. Correlated Electrons | Z.X. Shen (Stanford) |
| 3. Catalysis and Chemistry | Robert Schlögl (Berlin) |
| 4. Nano-Materials for Energy Applications | Rick Osgood (Columbia) |
| 5. Life Sciences | Janos Kirz (Berkeley) |
| 6. Atomic and Molecular Physics | Nora Berrah (Western Michigan) |
| 7a. Matter under Extreme Environments | Rus Hemley (Carnegie Institution, D.C.) |
| 7b. Environmental Science, Earth Science | Gordon Brown (Stanford) |
| 8. Novel Structural and Electronic Materials | Julia Phillips (Sandia) |
| 9. Cross-Cutting Issues | John C. Hemminger (Irvine) |

The charge to the discussion groups emphasized identifying connections between major new research opportunities and the capabilities of next-generation light sources. They were asked to identify “killer applications” in basic energy research — capabilities that will lead to dramatic advances in observational and control science, or that are essential to remain competitive internationally. Both accelerator-based light sources and novel laser-based sources for the vacuum ultraviolet (VUV) to X-ray range were considered. In contrast to many other studies, however, the design of the light sources was off-limits. Only the required performance was to be defined and quantified in terms of “photon attributes,” such as:

- Energy range (from VUV to hard X-rays)
- Coherence (both transverse and longitudinal)
- Intensity (photons per pulse and photons per second)
- Brightness (ultrahigh brightness plus low electron emittance)
- Temporal structure (nano- to attoseconds)

To help stimulate the deliberations of the discussion groups, the workshop featured four plenary talks that highlighted the current state of the art for four potential classes of future photon sources:

- Free Electron Lasers, presented by Claudio Pellegrini (UCLA)
- Energy Recovery Linacs, presented by Georg Hofstaetter (Cornell)

- Laser-based Sources, presented by Wolfgang Sandner (Berlin)
- Next-generation Storage Rings, presented by Nils Martensson (Lund)

After lively discussion of the science opportunities presented in this report, the participants concluded that no single light source that is now envisioned is capable of spanning the space of all the science opportunities. High peak brilliance and ultrashort pulses are needed to probe the small numbers of molecules in a chemical reaction and capture the fast dynamics of bond breaking and making, for example, but high average brilliance at lower peak intensity and high repetition rate are needed for high-resolution spatial imaging to avoid radiation damage and space-charge effects. Research and development on multiple kinds of sources should be pursued to define and extend the limits of their performance and to enhance their practicality, affordability, and usability.

The participants also noted that the photon source itself, no matter how brilliant, fast, or coherent, is not enough to solve grand challenge problems in science and energy. Beyond the source, sophisticated, fully equipped end stations, wide-angle ultrafast detectors with high energy resolution, and massive and efficient data-handling capability must be implemented. The scientific payoff of next-generation light sources depends crucially on full support for these key experiment-based technologies. Although light sources are experimental tools, the theory of as-yet-unobserved ultrafast phenomena will play a major role in understanding this new frontier and in developing the control science needed to apply it. The integration of theory with next-generation light source experiments should be specifically supported.

Another theme that emerged from the workshop is the need for interdisciplinary approaches to grand challenge science. Such grand problems as the functionality of protein assemblies in cells; the strong correlation of electrons in superconductors, insulators, and magnets; the rational design of catalysts; and the efficient conversion of energy between chemical bonds and electricity are not confined to one experiment or one field of research. They often require multiple experiments across facilities for scattering X-rays, electrons, and neutrons, and they must integrate sophisticated materials synthesis and forefront theory. The traditional model of single investigators applying for one-time use of a single facility does not encourage this kind of interdisciplinary grand challenge science. Fourth-generation light sources and other facilities should learn to accommodate the cross-platform and interdisciplinary needs of grand challenge science.

6. ORGANIZATION OF REPORT

This report is organized as follows. Chapter 3 outlines science drivers for next-generation light sources, taken from sustainable energy, information science, catalysis and chemical change, environmental science, materials for extreme environments, life sciences, enzyme chemistry, and correlated electrons. These science opportunities exploit the cross-cutting capabilities of fourth-generation light sources on the basis of their unique brilliance, time structure, and coherence; these cross-cutting capabilities are presented in Chapter 4. Summary conclusions are presented in Chapter 5.

Appendix 1 describes the expected photon attributes of the light sources and lasers now being built or proposed for consideration, including third-generation synchrotron rings, fourth-generation free electron lasers, energy recovery linacs, and high harmonic generation lasers. The science drivers for next-generation light sources are elaborated in detail in Appendix 2, supplementing the discussion of scientific opportunities in Chapters 3 and 4. Appendix 3 summarizes the related workshops, reports, and studies that complement this report. Appendices 4, 5, and 6 present the charge, agenda, and participant list of the Photon Workshop.

7. CONCLUSION

As articulated in this report, workshop attendees concluded unambiguously that the X-ray sources needed to meet the challenges of energy research in the future do not exist. Furthermore, no one source currently envisioned can meet the competing demands of peak brilliance and average brilliance. As such, concerted efforts to define a suite of photon sources that collectively can meet these needs should be pursued. The enabling research and development to meet the technology challenges associated with these next-generation sources should be vigorously pursued. Only through the development of such future sources, appropriately integrated with advanced end stations and detectors and closely coupled with broader synthesis, measurement, theory, and modeling tools, can we meet the demands of a New Era of Science.

REFERENCE

1. *New Science for a Secure and Sustainable Energy Future*, Basic Energy Sciences Advisory Committee, December 2008, <http://www.sc.doe.gov/bes/reports/list.html>.

3. PHOTON SCIENCE DRIVERS

1. NANOMATERIALS FOR ENERGY APPLICATIONS

Advanced systems for the sustainable production, storage, and utilization of energy, such as solid-state lighting, photovoltaics, batteries, and fuel cells, depend critically on the development of new materials that can meet demanding performance requirements. Key challenges include observing the formation mechanisms of desired material and molecular phases, determining the nanoscale structure of nucleation sites, and following the dynamics of structural and electronic changes on attosecond to second time scales. Developing a capability to observe *in situ* the atomistic mechanisms of materials synthesis is essential if we are to achieve the fundamental understanding that will enable transformation of empirical trial-and-error efforts at synthesis into science-based materials and process design. A second area of emphasis is the need for understanding the effect of specific defects on the performance of a material or device. The ability to observe the evolution of defects and the nanostructural changes they induce in a material during device operation will enable unprecedented understanding and control of such features in real devices. In addition, electronic properties crucially determine the device performance. Generation, transport, and trapping of charges are key parameters that need to be observed in real time and with sufficient spatial and temporal resolution to characterize their behavior at interfaces, grain boundaries, and nanostructural features that control macroscopic performance.

Application I: Spectroscopy of Individual Nanoparticles in a Solar Cell

One promising approach to high-efficiency solar cells is to utilize quantum-dot nanostructures for charge generation and separation. Quantum dots (QDs) offer a unique advantage, exploiting quantum confinement to control the relaxation dynamics of photogenerated carriers so as to yield either a) enhanced photocurrent through efficient multiple exciton generation or b) enhanced photopotential through hot-electron transport and transfer processes (Figure 1). To realize these desirable effects, it is necessary to determine and control the dynamics of hot-electron and hot-hole relaxation, charge transport, and interfacial charge transfer. These processes have characteristic lifetimes and relaxation times, ranging from femtoseconds to nanoseconds, and they are extremely sensitive to the quantum-dot material and its interfacial properties.

Because nanoparticle surfaces and interfaces play a key role in multiple exciton generation and its efficiency, it is crucial to understand these interfaces. X-ray photoemission spectroscopy (XPS) will provide unique characterization of the individual nanoparticle and its interface. The small size of the dot makes this a demanding task, requiring much higher average brilliance than today's soft X-ray sources offer. Following the picosecond relaxation of hot electrons and holes requires 100 femtosecond or shorter X-ray pulses and high peak brightness available only on next-generation light sources.

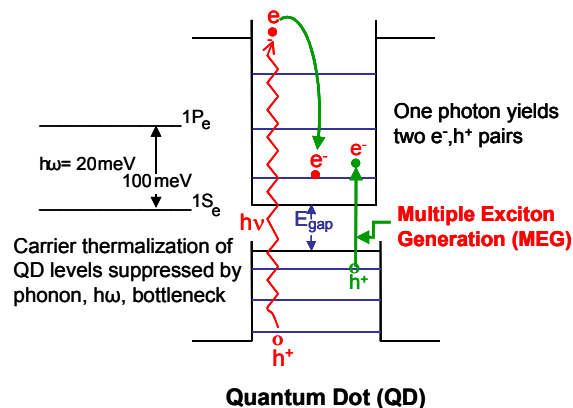

Figure 1 In quantum dots used for solar cell applications, the absorption of one incident photon can lead to the creation of more than one electron-hole pair. This is an inverse-Auger process, which is enhanced in a quantum dot by quantum confinement and the relaxation of the requirement to conserve momentum. Furthermore, thermalization of high-energy carriers is suppressed by the phonon bottleneck produced by the large energy separation of quantized levels. A.J. Nozik, *Physica E* **14**, 115 (2002).

Application II: Charge Transfer Dynamics in Photosynthesis

Critical scientific challenges in solar fuels generation require the efficient coupling of ultrafast, single-electron, excited-state photochemistry in molecular photosensitizers to catalysts for generating chemical fuels using transition metal complexes. In fact, biology has already achieved the goal of efficient solar-initiated water splitting coupled to reductive chemical-energy storage using abundant, renewable, self-assembling “soft” materials. Emerging work suggests promising bio-inspired synthetic pathways for achieving comparable solar fuels catalysis in organometallic and inorganic systems. However, progress in the development of solar-energy-converting materials is restricted by the lack of information on time-dependent photoexcited electronic and structural changes and by the determination of how these structural dynamics are linked to reaction chemistry (Figure 2).

The development of advanced light sources for dynamic structure determination would create opportunities for the ground-breaking discovery of the chemical processes that underlie solar-energy conversion across the full range of photocatalytic materials. It would also provide a strategy to accelerate solar-fuel catalyst development by enabling information on structure-dependent, excited-state energy-conversion processes to be included in synthetic design. Particularly significant would be the development of advanced light source facilities with capabilities for photoexcited-structure mapping using short-pulse X-rays across a broad X-ray energy range. These studies would require a) tunable femtosecond pulses at hard X-ray energies for combined high-resolution spectroscopy and anomalous-scattering experiments; b) high-energy pulsed X-rays for high-resolution, time-resolved pair distribution

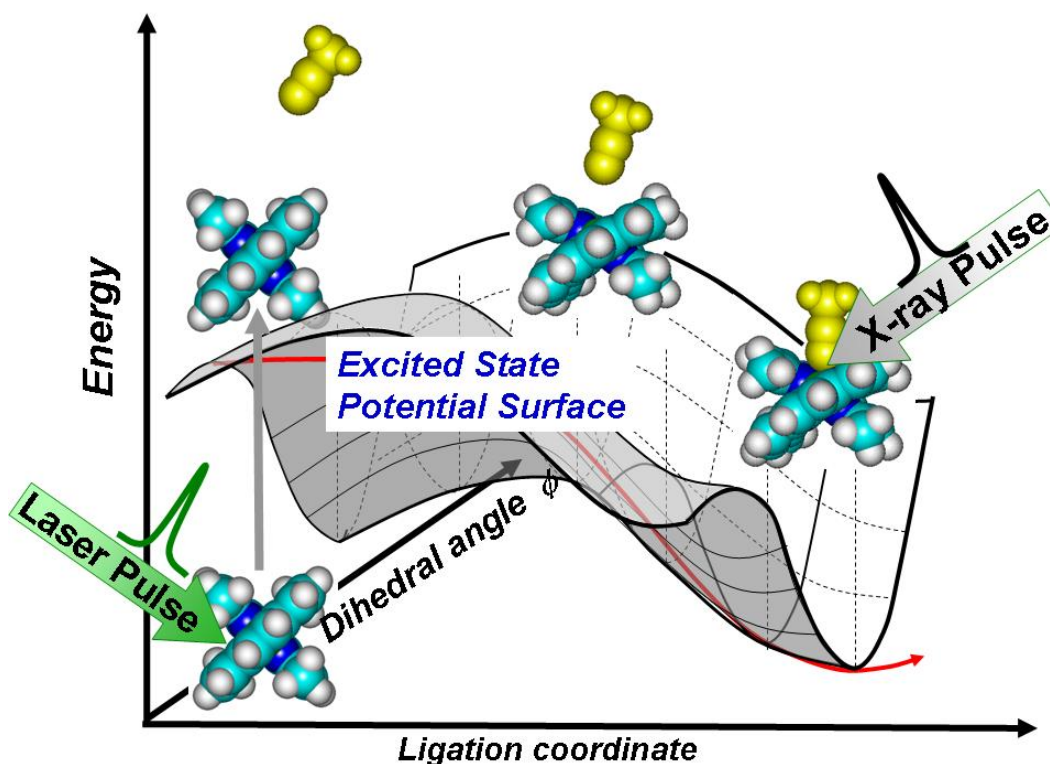

Figure 2 Structural dynamics of a photoactive copper complex excited state created by green laser pulses followed by X-ray pulses to capture both dihedral angle movements on 100-fs time scale and ligation coordinate changes on ps to ns time scale. [Chen et al., *J. Am. Chem. Soc.* **124**, 10861-10867 (2002); **125**, 7022-7034 (2003); **129**, 2147-2160 (2007)]. This research may guide synthesis in finding low-cost first-row transition metal complexes to replace precious metals in solar-energy-conversion processes.

function analyses; c) low-energy X-rays for time-resolved electronic structure analyses of transition metals and sulfur ligands; and d) continuously tunable, ultrafast two-dimensional (2-D) IR techniques extending into the far infrared and terahertz regions of the electromagnetic spectrum for directly measuring functionally critical vibronic and electronic coupling of the photosensitizers and active sites to their environments.

Application III: Battery Stress and Degradation—Single-Particle Imaging and Spectroscopy

Battery technology is critical to a wide range of applications, but it is particularly important for transforming transportation from an oil-based to a charge-storage-based technology. It is estimated that improvements in battery-storage efficiency by a factor of five are needed. This enhancement demands a fundamentally new understanding of the factors that limit battery performance. The current frontiers in structural science that are related to energy-storage materials are complexity, heterogeneity, size, and defects in the materials of interest under a diverse array of special conditions, including extreme chemical gradients. Several general features are desirable in investigating heterogeneous materials for battery applications. For example, simultaneous real-time imaging of changes in chemistry and atomic arrangements is desirable, with a time resolution appropriate for the process of interest, typically ~ 1 millisecond to 1 minute for the charge-discharge cycles of batteries. We need new ways of following these processes, including a) *in situ* measurements of atomic arrangements, using combined X-ray scattering and absorption techniques under severe chemical gradients; b) combined hard X-ray microdiffraction and fluorescence for simultaneous identification of phase, composition, and contaminant sorption; c) time-resolved *in situ* measurements of reaction pathway and kinetics; and d) small- and wide-angle X-ray scattering and pair distribution function analysis to explore nanomaterials during the particle nucleation-ripening-growth cycle.

Nanophase materials have particular importance for advanced battery technology because they can tolerate high internal mechanical stress during charging (Figure 3). Coherent (lensless) imaging is an X-ray technique with the ability to resolve ultrasmall sample features. Coherent imaging techniques are being developed on today's third-generation X-ray sources, but the coherence of the beams is too small to achieve the sensitivity and resolution needed for analyzing nanophase structural materials for batteries, hydrogen storage, or solar cells. The achievable spatial resolution improves as the coherent flux to the inverse fourth power.

Extrapolating from today's demonstration experiments, a coherent dose of about 10^{14} photons in a $10 \times 10 \text{ nm}^2$ beam is needed to record an image with the required atomic resolution of $\sim 0.2 \text{ nm}$. Studies of the structural evolution of nanophase materials *in situ* and under operating conditions are envisioned, including the ability to record images with a time resolution of seconds or faster. Similarly, spatially resolved electronic properties can be studied using X-ray emission spectroscopy under operating conditions, using the high brilliance of next-generation sources. High average brightness and high

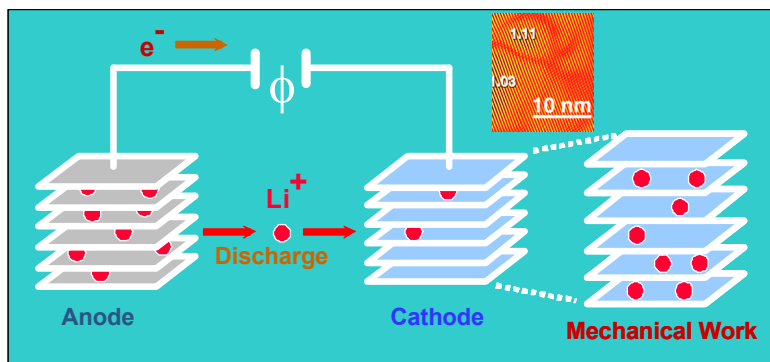

Figure 3 Nanoparticles and nanophase materials can be used in advanced batteries, where their resilience to battery charging can enhance battery performance. The inset shows nanophase tetragonal $\text{Li}_2\text{Mn}_2\text{O}_4$ (image courtesy of Yet-Ming Chiang, MIT).

coherence are the required light source attributes. Although high average brightness is needed, high peak brightness is a major challenge in these experiments because of the sample damage it can cause.

Application IV: Structure and Properties of Individual Mass-selected Clusters

Clusters and cluster-assembled materials represent novel nanosystems with great technological promise in the areas of catalysis, new materials, fuel cell applications, aerosol chemistry, combustion, and magnetic data storage. Understanding and controlling the physical and chemical properties of these materials is important for realizing these goals.

Direct structural determination and manipulation of individual size-selected clusters constitute major scientific grand challenges in nanoscience. The physical and chemical properties of atomic clusters change dramatically with size and structure, a fundamental feature of nanoscience. Size-selected clusters provide the best-defined models for heterogeneous catalysts. Furthermore, size-selected clusters provide the means to discover and fabricate tailor-made new materials with specific magnetic, optical, or electronic properties. Atomic structures are the most fundamental properties of size-selected clusters, but there are currently no experimental methods for directly determining them.

Individual clusters are generally produced by evaporation of the bulk material and condensation in a molecular beam, followed by mass selection of the ionized species. This creates a very dilute target for X-ray diffraction studies. Target density can be increased by storing the particles in an electromagnetic ion trap. Multiple complementary techniques must be exploited for the characterization of these dilute systems. These include XPS for chemical characterization and structural information, ultraviolet photoelectron spectroscopy for electronic properties, circular magnetic X-ray dichroism for magnetic properties, and EXAFS for structural determination (Figure 4). Still, the number of clusters in the trap, 10^4 to 10^6 , is too small to allow reliable EXAFS measurements. Good signal-to-noise data should be obtainable, given the high average brilliance of the next-generation sources supplying 10^{16} to 10^{18} photons per second and their tunability. The most comprehensive structural information comes from X-ray diffraction. The most exciting prospect would be to use a single intense X-ray pulse to scatter off a single size-selected cluster to yield its entire three-dimensional structure. Such experiments may be within reach with the high peak brilliance of next-generation light sources and the development of sophisticated scattering analysis procedures.

2. INFORMATION TECHNOLOGY: CONTROLLING SPIN AND CHARGE IN COMPLEX MATERIALS

Spin and charge are the basic ingredients for storing and processing information. Technology constantly strives to push the limits of storage density as well as the speed of storing, retrieving, and processing information. Moreover, coupling of charges and spins can lead to new phenomena, such as high-temperature superconductivity, which have important implications for the energy grid of the future.

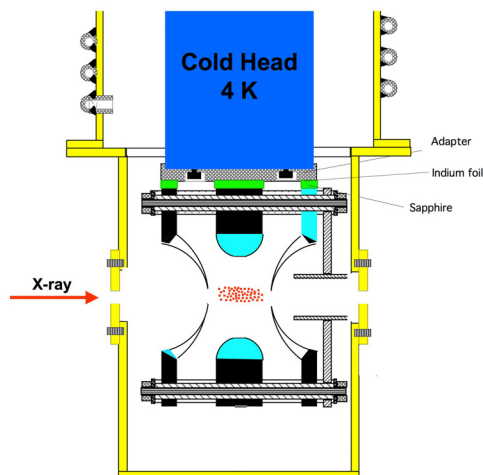

Figure 4 A temperature-controlled ion trap for EXAFS of size-selected clusters. X.B. Wang and L.S. Wang, *Rev. Sci. Instrum.* **79**, 073108 (2008).

Application I: Coherent Manipulation and Time-resolved Imaging of Spin and Magnetic Properties

Quantum-dot-based materials are the storage materials with the highest data density known. Coherent rotation of spins in these dots significantly enhances the writing speed of magnetic memory. Using conventional magnetic fields, writing speeds of less than 100 picoseconds can be achieved, whereas with a femtosecond photon pulse, it has been demonstrated that the magnetization can be changed on the 100-femtosecond time scale, although the exact nature of this switching process is not yet resolved (Figure 5).

Time-resolved holographic imaging with circular magnetic X-ray dichroism will allow mapping of the spatially resolved changes in the spin and orbital momentum, following stimulation by a femtosecond laser pulse. This will reveal new details about the transfer of spin momentum to other degrees of freedom, such as the lattice, which enables the change in magnetization. This requires a short-pulse, soft X-ray circularly polarized source with a photon energy tuned to individual absorption edges and synchronized with an external laser.

Application II: Ultra-high-resolution Spectroscopy of Electronic Properties and Correlation Effects in Complex Oxides and Related Materials

Transition metal oxides and related materials will be the basis for many future energy and information-based technologies. X-rays can be utilized to understand, predict, and control the electronic structure and dynamics underlying the functionality of these materials. This will enable the understanding of emergent phenomena and collective excitations resulting from the coupled degrees of freedom and competing ground states that drive novel electronic behavior. For instance, high-resolution resonant inelastic X-ray scattering (RIXS) can reveal information on low-energy charge correlations that may help solve the puzzle of the pairing mechanism responsible for high-temperature cuprate superconductivity. This new understanding will also enable the design and control of these materials and their interfaces to bring about new functionalities. This can be achieved by probing the electronic structure with unprecedented space, time, spin, and energy resolution. This requires much higher photon flux density to enable spin-resolved angle-resolved photoemission spectroscopy (ARPES) and nano-ARPES to be performed with meV resolution, and short photon pulses to access fundamental time scales ranging from 1 femtosecond (characteristic of electron correlations) to hundreds of femtoseconds (characteristic of coupling to lattice modes), using pump-probe ARPES (Figure 6). In addition, high flux is necessary in order to perform coincidence experiments involving more than one photoelectron that directly quantify electron-electron correlations. ARPES and X-ray measurements with a circularly polarized photon beam can provide information on the presence of unconventional or “hidden” electronic order. All of these experiments will require a photon source with high average brilliance.

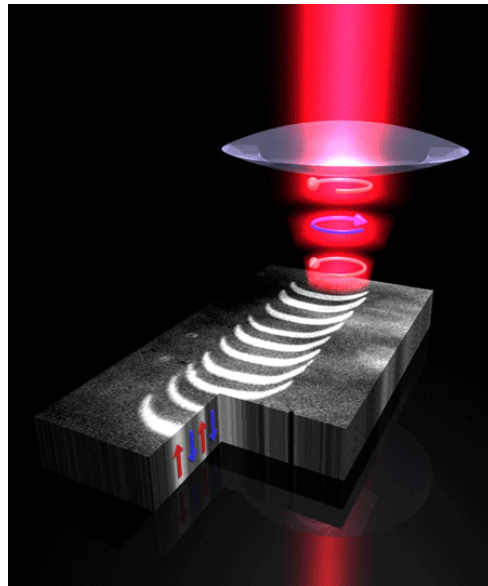

Figure 5 Magnetic domain pattern written by circularly polarized laser pulses. The magnetization reversal is thought to proceed via a coherently excited intermediate state that could be characterized by future light sources. C.D. Stanciu *et al.*, Phys Rev. Lett. **99**, 047601 (2007).

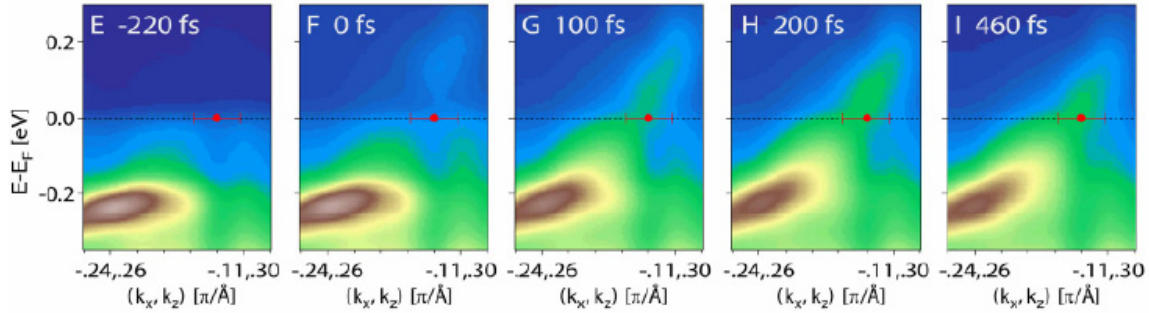

Figure 6 Melting of the charge density wave state in TbTe_3 and its evolution with time as revealed by pump-probe ARPES. Oscillations in time of the electronic structure give important information on the coherent collective excitations of the correlated state. F. Schmitt *et al.*, *Science* **321**, 1649 (2008).

Industrial Involvement at Photon Sources: Examples from IBM

IBM, a major microelectronics company, has been a continuous user of the DOE/BES synchrotrons for over 30 years. The information content gleaned from the data collected at various beamlines at the synchrotron has provided insight into the structure and operation of many innovative microelectronic devices. Data collected from the synchrotron has become engrained into the R&D culture at IBM.

- Time-resolved X-ray diffraction (XRD) recorded at the National Synchrotron Light Source (NSLS) has been used for years to improve on three generations of metal silicides for microelectronics: first TiSi_2 , which was replaced by CoSi_2 , which is currently being replaced by NiSi (Figure 7). In each case, the ability to quickly assess phase formation of thousands of samples in real time during process-like annealing conditions has enabled IBM to develop optimal compositions and processes for the metal silicides. These materials are used to form low-resistance contacts between the “wiring” and device (transistor or memory) parts in a chip. The development of alloyed metal silicides, achieved by substantial time usage of a beamline at the NSLS, has had a significant monetary impact on IBM's chip business bottom line.

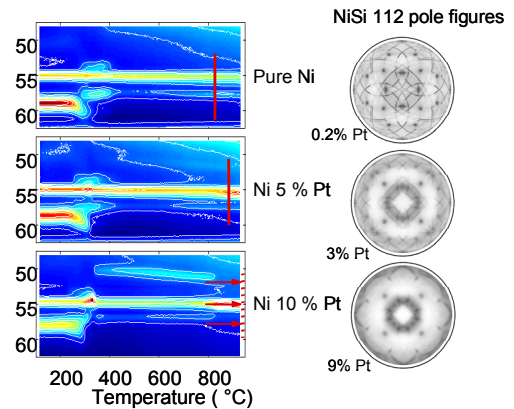

Figure 7 *In situ* temperature-resolved pole figures of NiSi alloyed with different amounts of Pt. Stability is increased by adding small amounts of Pt. From C. Detavernier *et al.*, *J. Appl. Phys.* **93**, 2510 (2003); *Appl. Phys. Lett.* **84**, 3549 (2004).

- Phase-change memory (PCM) is a new type of memory device being developed for “universal memory.” The advantages of PCM include rapid switching – PCM is more than 500 times faster than RAM; low power – PCM uses less than one-half the power to write data; and extreme density – PCM cell is nanotechnology (3 nm by 20 nm in size). It is predicted to grow to a \$76 billion industry by 2019 and occupy 80% of the memory market. IBM introduced a prototype device in 2006, based on a new GeSb alloy. *In situ* temperature-resolved XRD and grazing-incidence X-ray diffraction (GIXD) data collected at the NSLS were utilized to find optimal materials and test for scalability (Figure 8).

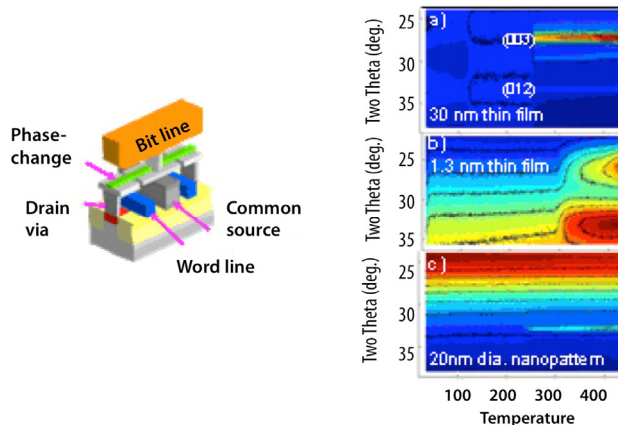

Figure 8 Time-resolved X-ray diffraction plots showing GeSb phase-change material scaling effects. From S. Raoux *et al.*, *J. Appl. Phys.* **102**, 094305 (2007) and **103**, 114310 (2008).

3. CATALYSIS AND THE ENERGY CHALLENGE: IMAGING AND CONTROLLING CHEMICAL REACTIONS

Catalysis—the essential technology for accelerating and directing chemical transformation—is the key to realizing environmentally friendly, economical processes to supply sustainable chemical fuels for our growing energy needs. Producing such fuels as hydrogen from solar water splitting, alcohols from the cellulose of plants, and hydrocarbons from recycled carbon dioxide requires the design and optimization of a diversity of novel catalytic processes. Despite enormous efforts in catalysis science, the rational design of catalysts and chemical reaction pathways for sustainable production of fuels is not possible today. Instead, technical chemical processes are developed by empirical and combinatorial methods that add little to fundamental knowledge of catalysis. The required step change in catalysis can be achieved by understanding the course of chemical reactions on all relevant scales of space, time, and energy. Such a complete picture has not been achieved in any relevant reaction due to the absence of analytical tools that allow probing of the reactions without severe compromises to the reaction conditions. This challenge is magnified by the intrinsic complexity of catalyst surfaces, the number of intermediate chemical states, and the variety of competing chemical pathways for converting reactants into products. Future photon sources will provide, for the first time, the possibility of obtaining a complete picture of chemical reaction dynamics, thereby enabling the rational design of chemical transformations.

The electronic and geometric structures of catalytic materials under reaction conditions determine their efficiency, selectivity, and lifetime. Of particular value is the observation of the temporal evolution of catalyst structure at temperatures, pressures, and reactant concentrations similar to those used in industrial practice. Preliminary measurements of this type clearly illustrate that catalyst structure and morphology typically change under reaction conditions and over time. Even extended solid surfaces, traditionally thought to be static, may undergo thermal fluctuations and rearrangement, in addition to undergoing substantial changes in morphology as the catalyst makes and breaks bonds with the reactants and products. Because the geometric and electronic structures of catalysts are inextricably linked, a comprehensive knowledge of both is central to controlling catalytic efficiency and selectivity.

The challenge of energy production in living systems has been solved by evolution. It is of fundamental importance to understand the catalytic strategies and energy conversion pathways that nature has developed. These typically operate effectively at ambient conditions and with inexpensive, abundant

materials, unlike human-engineered chemical reactors that often require high temperatures and precious metal catalysts. Only a firm, mechanistic understanding of biological energy conversion will allow decisions about the potential usefulness of biological or bio-inspired approaches for human energy applications. Next-generation light sources are critical for creating this understanding.

Application I: Time-resolved Spectromicroscopy of Real Catalyst Surfaces under Reaction Conditions

Knowledge of the reaction mechanism is central to understanding catalytic reactions. The atomic structure, energies, and electronic structure of the initial reactant state, the final product state, and the activated complex transition state must be characterized for each elementary step. The design of improved catalysts and photocatalysts requires an understanding of how the energetics and dynamics for each step depend on the details of the dynamic structure of the active site and its surroundings, including the reaction media. Achieving this depth of understanding will require temporal measurements on time scales ranging from 10^{-18} s for electronic excitations, 10^{-15} s for atomic rearrangements, to 10^4 s for macroscopic morphological changes occurring over many reaction cycles. This has to be performed with nanometer spatial resolution, since catalysts are by design inhomogeneous materials (Figure 9). Photoemission microscopy will provide a key approach to this challenge, requiring the highest possible average brilliance of the source in the soft X-ray range.

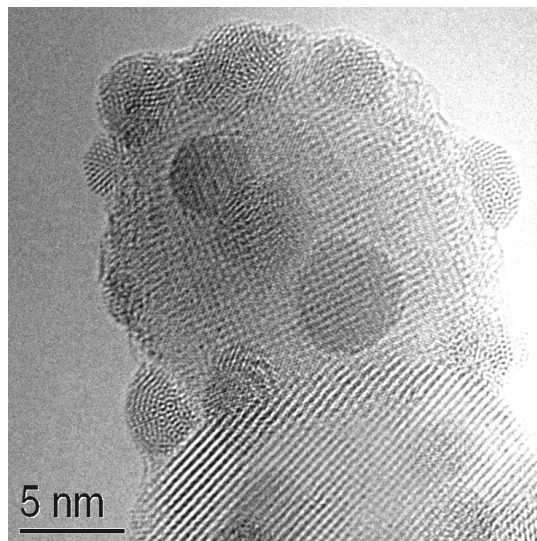

Figure 9 Structural complexity of a heterogeneous catalyst: the system Ag/TiO₂ is used for selective hydrogenation of unsaturated hydrocarbons. Inspection of high-resolution TEM shows large variations in local structure that presently cannot be assessed in their functional consequences, as we have no local probes at this level of resolution (image courtesy of Wang Di and Robert Schlögl, FHI Berlin).

Application II: Femtosecond Movies of a Chemical Reaction—Capturing and Controlling the Transition States

The ultimate goal for making “molecular movies” is to learn how to drive a chemical reaction down a desirable path. Current coherent control studies modulate laser pulses to drive reactions, but virtually no structural information is available from these studies. For an in-depth understanding and control of a chemical reaction, the transition states of the activated complex must be known. The transition states in a chemical reaction are defined as the states with the highest energy barriers along a reaction pathway. Structures of these states show how and which atomic movements transform reactants to products. Although the transition states have been predicted by theory and simulation, they have eluded experimental observation due to the lack of tools for structural imaging with a time resolution compatible with the barrier crossing time (Figure 10). Therefore, it is essential to image molecular structures in the entire chemical reaction pathway, including the transition state structures, on time scales as small as 10 femtoseconds and longer. Using femtosecond X-ray spectroscopy combined with wide-angle scattering, the structural information for reaction intermediates during coherent control processes can be obtained. These methods map out reaction potential hypersurfaces and identify key reaction coordinates that are the most relevant in driving reactants to products through coherent control. This requires femtosecond X-ray pulses with the highest peak brilliance, synchronized to an external laser.

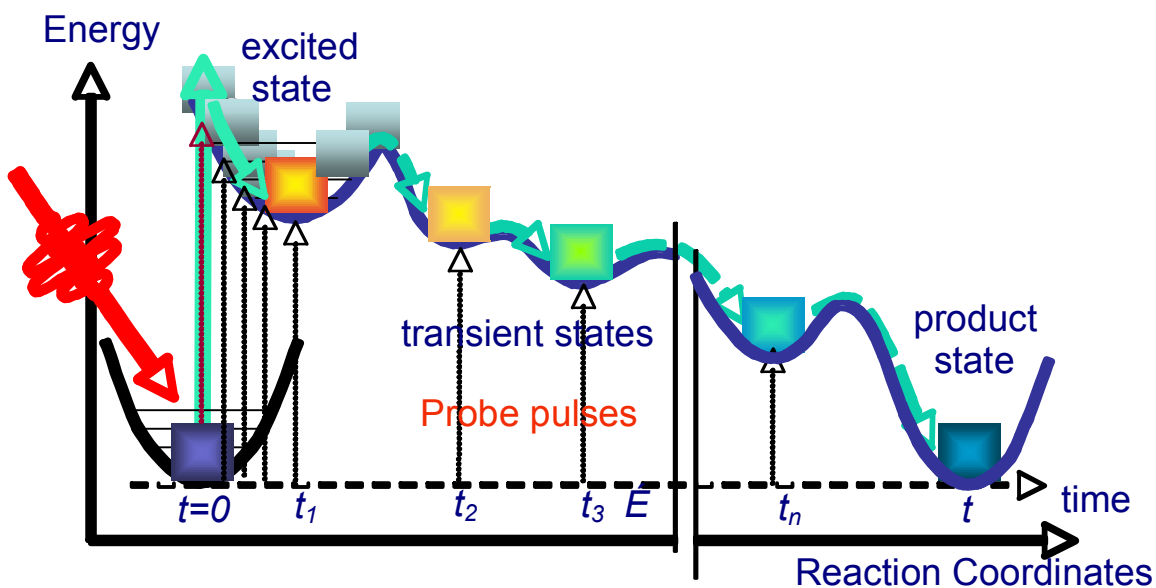

Figure 10 A femtosecond molecular movie. A laser pulse excites the system, and then the resulting cascade of transient states is probed at various time intervals until the product state is formed (image courtesy of Lin Chen, Argonne).

4. ENVIRONMENTAL SCIENCES: IMAGING STRUCTURE AND REACTIVITY OF INDIVIDUAL NANOPARTICLES

Nanoparticles have highly reactive surfaces in biological, catalytic, and environmental settings; these surfaces are thought to be the locations of most of the naturally occurring chemical reactions in the Earth's biosphere. High-priority science targets include characterization of the mineral-water interface structure and dynamics, nanoparticle reactivity and transport, interactions of microbial organisms with mineral surfaces, and life in extreme environments. These goals require structural and dynamic studies of chemical and biological reactions at the surfaces of nanoscale earth materials as a function of particle size, chemical conditions, biological environment, temperature, and pressure. The systems of interest range from the purely inorganic to complex mixtures of inorganic and organic matter and biological organisms. Understanding reactivity on nanoparticle surfaces is crucial for a wealth of energy-related and environmental processes and materials, including the remediation of environmental damage, viability of carbon sequestration in deep geological reservoirs, and the stability and dynamics of clathrate hydrates that store methane.

Application: Imaging Structure and Reactivity of Mineral Particles in a Wet Environment

CO₂ sequestration in deep geologic reservoirs, and understanding the interaction of geothermal fluids with earth materials, will require studies of the interaction of supercritical CO₂-H₂O fluids with rocks and minerals deep underground, under conditions that add significant complexity to synchrotron-based scattering and spectroscopic studies of nanoparticle surfaces. The structure of solids in contact with aqueous solutions and supercritical CO₂-H₂O-brine mixtures characteristic of deep (> 800 m) geologic formations could be determined through X-ray scattering studies of individual nanoparticles. This objective is extremely challenging, however, requiring synchrotron light sources with average brightness four to five orders of magnitude greater than that of any existing light source, and sample cells that can produce the full range of temperature, pressure, and chemical environments that such particles experience in deep-Earth geologic formations, while also allowing access for X-ray beams for scattering,

spectroscopy, and imaging studies. In addition, EXAFS studies of diagnostic probe ions adsorbed on nanoparticle surfaces at low surface coverages ($< 10\%$ of a monolayer) will yield information on reactive surface sites because of the sensitivity of EXAFS to second-neighbor distances. At present, such experiments can be carried out only on collections of nanoparticles having significant interface areas of tens of square micrometers (Figure 11). A next-generation light source with the high average brilliance and tunability needed for EXAFS would make it possible to carry out such studies on individual nanoparticles in a size range of 5-10 nm, or on accessible surfaces of irregular or dynamically changing materials.

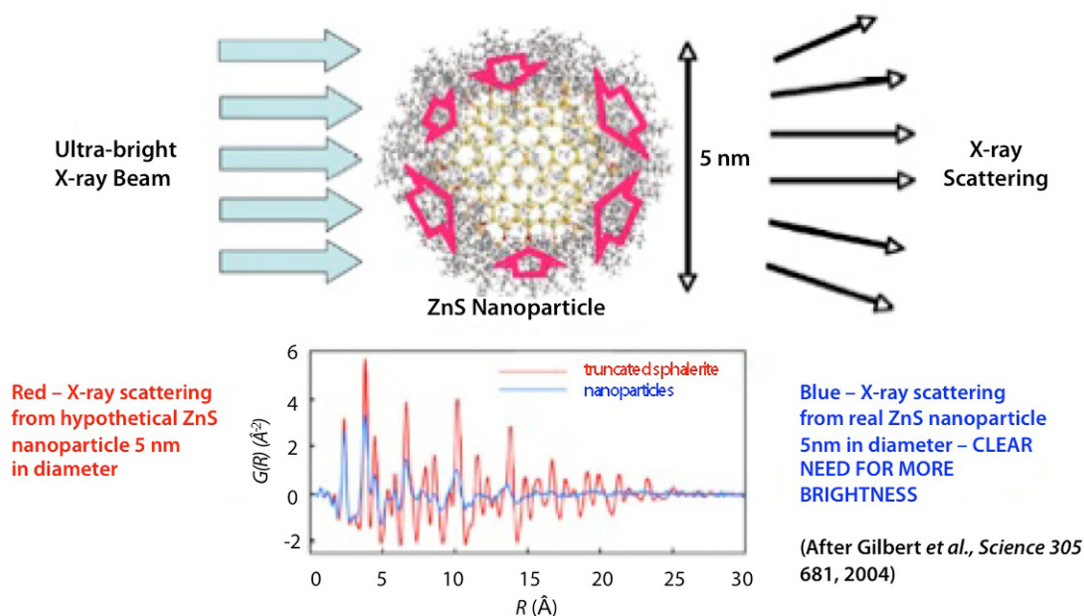

Figure 11 X-ray scattering from a hypothetical individual 5-nm ZnS nanoparticle, compared with experimental scattering from a collection of 5-nm ZnS nanoparticles, showing the clear need for increased brightness. B. Gilbert *et al.*, *Science* **305**, 651 (2004).

5. MATERIALS AND PROCESSES UNDER EXTREME ENVIRONMENTS

Extreme conditions are crucial for understanding and making new materials with novel properties for energy production, storage, and use that are superior to those of any material known today. Extreme environment studies provide a route toward discovering new materials with enhanced performance for a broad range of applications, from energy transformation, to energy storage, to energy transmission, sensing, and monitoring. Next-generation energy technologies also demand enhanced performance of components exposed to thermomechanical, chemical, radiation, and electromagnetic extreme environments. A good example is nuclear reactors operating at twice the temperature and several times the neutron radiation dose used today. Components must show minimal fatigue, corrosion, and degradation over time. Moreover, the ultimate clean energy solution, fusion, occurs only under extreme conditions of density, temperature, and pressure. Research on materials and processes in these environments provides the fundamental knowledge needed to address and solve these energy-related problems.

Application: Characterization of Fusion Plasmas by X-ray Imaging

High fluxes of photons can be used to drive materials into new states of matter. Shock compression increases pressure and temperature, and with new techniques, the compressive drives can be shaped to program the strain rate from near-shockless loading to extremely high deformation rates that generate transient gigabar pressures and 10^3 electron-volt (keV) temperatures. These classes of experiments on large laser platforms for hydrogen are important for inertial confinement fusion. They explore the outer limits of material physics (i.e., warm dense matter).

A detailed understanding of material properties over a very broad range of pressure and temperature is required for truly predictive capability regarding inertial confinement fusion implosions. For example, the hydrogen fuel in a typical ignition implosion design spans temperatures from 20 K to 10^8 K, pressures up to 10^8 Mbar, and densities ranging from 0.2 g/cm^3 to 1000 g/cm^3 (Figure 12). The opacity, density, and compressibility of the ablator material surrounding the fuel pellet, combined with the density of the compressed fuel, will determine how sensitive the implosion is to instabilities, which can potentially quench ignition. Transport properties of the hot dense ablator, the cold dense fuel, and the central hot-spot in the fuel that ignites fusion can also significantly affect the performance of ignition implosions. The production and characterization of some of these states requires next-generation light sources in combination with large, high-energy-density drivers, such as lasers. For example, ultrahigh-resolution X-ray images taken during a sequence of strong shocks are needed to determine density profiles, thereby revealing equation-of-state and transport information. The optical properties of this warm-to-hot dense matter, using broadband X-ray sources, are needed to determine opacities. Compton scattering from dense fuel can give temperature and collisionality of the dense plasma. Each of these experiments would require significantly greater capability than currently exists for the light source, as well as for the high-energy-density driver creating the compressed states of matter. For instance, the Compton experiment would require a narrow bandwidth with 10^{10} – 10^{13} photons per pulse every 10–100 picoseconds.



Figure 12 The “warm dense matter” regime is not only important for understanding dense plasmas in planets like Saturn, but also for understanding inertial confinement fusion implosions.

6. LIFE SCIENCES: IMAGING OF CELLS AND CHROMOSOMES

The biosciences have the potential to deliver scientific knowledge and strategies that can significantly enhance, even revolutionize, energy sustainability and security, environmental remediation, and global climate change. Understanding how nature designs and builds functional architectures, ranging from the arrangements of atoms that make up proteins, through proteins interacting as complex molecular machines that drive living processes, to the organelles and cells that package, regulate, and control the systems of life, is truly an overarching grand challenge. Achieving a molecular-level understanding of the structure of large macromolecules and their complexes, the interactions between macromolecules in larger assemblies that confer and control function, and ultimately the organization and networking of these assemblies at the cell and tissue level will provide a knowledge base and a predictive understanding of complex biological systems from the sub-nanometer scale through the cellular level. A combination of experimental approaches, including macromolecular crystallography of sub-micrometer-sized crystals, sub-picosecond to microsecond time-resolved diffraction, and small-angle X-ray scattering experiments, will be needed to address these complex problems. Information from such studies will be combined with that from other methodologies, such as imaging on the nanoscale, and molecular dynamics simulations to

achieve a global biological systems perspective. Success in this area will transform medicine, renewable energy research, environmental remediation, and other fields that are informed by or harness biological systems.

Application I: Flash Imaging of Cells and Other Biological Structures

How are macromolecular complexes organized into organelles, and how are organelles organized within the cell? The bulk of our knowledge in this area comes from electron microscopy. While providing superb resolution, it is limited to very thinly sliced samples. In contrast, visible-light microscopes are limited in resolution but penetrate more deeply into biological materials. X-ray microscopy and, specifically, cryo-X-ray three dimensional (3-D) tomography, has been developing rapidly, with the goal of filling the gap between electron and visible-light microscopies. This powerful new technique is providing exciting results at the 30–50-nm resolution level in intact cells, limited only by available X-ray optics. To go beyond the optics limitation, diffraction microscopy and other lensless forms of 3-D X-ray microscopy are being developed that require intense, coherent X-ray beams.

Coherent beams from light sources with high peak brilliance offer an additional advantage. Illumination with an ultrashort and extremely bright X-ray pulse can outrun key damage processes. A detailed analysis of imaging live cells with X-ray lasers suggests that nanometer to sub-nanometer resolutions could be achieved with intense, ultrashort X-ray pulses at wavelengths of ~ 0.5 -1.5 nm (Figure 13). This is substantially higher than resolutions possible in any other type of biological imaging experiments on non-reproducible objects. A high-resolution 3-D dataset from a non-reproducible object will require simultaneous flash illumination by pulses from many directions. This could, in principle, assure that significant damage does not occur during data collection. Orthogonal illumination can be realized in split-beam geometry with soft X-ray pulses, using multilayer mirrors.

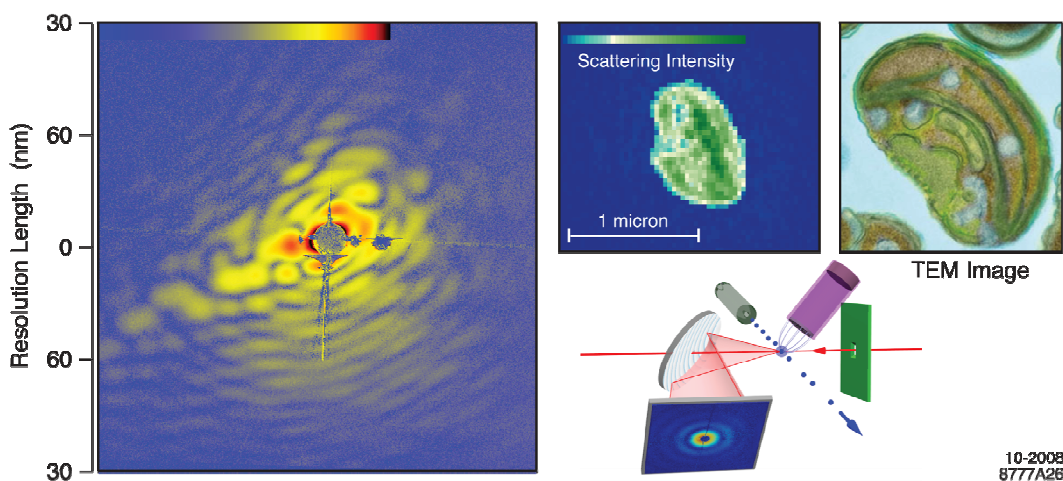

Figure 13 *Left*: Femtosecond single-shot X-ray scattering pattern. *Top middle*: The reconstructed image of a live picoplankton that was injected at 200 m/s into the beam of the soft X-ray laser FLASH operating at 7-nm wavelength, 15-fs pulse duration, and $\sim 10^{14}$ W/cm² power density; image reconstructed using Shrinkwrap (Sebastien Boutet) (Source: J. Hajdu *et al.*, private communication). *Top right*: transmission electron microscopy (TEM) image (Source: W. Eikrem and J. Thronsen, Univ. of Oslo). *Bottom right*: Schematic setup of the diffraction experiment. The soft X-ray image can be extended to molecular resolutions with an X-ray laser operating in the wavelength range from 0.5 to 1.5 nm.

Application II: DNA Packaging in Cell Nuclei

The chromosome is the blueprint of life. The molecular makeup of the chromosome can be sequenced, but among the many scientific questions in life sciences, the question of how deoxyribonucleic acid (DNA) and its associated proteins are arranged and packaged to fit within the $\sim 10\text{-}\mu\text{m}$ diameter in the cell nucleus is unknown. Moreover, the tightly packaged DNA is not genetically active and its structure, especially during activity, has remained largely inaccessible. The normal cellular contingent of DNA is $\sim 10^5$ -fold longer than the nuclear diameter. A DNA compaction of ~ 6 -fold can be accounted for by its wrapping around nucleosomes. The nucleosomal fiber is itself probably folded to yield a thicker fiber of $\sim 30\text{-nm}$ thickness, providing ~ 7 -fold more compaction. How this 30-nm fiber is folded to achieve the further necessary compaction is unknown. During activity, part of the structure has to be unraveled and only then becomes accessible to fulfill its genetic function.

The ability to obtain nanometer-resolution images of the higher-order DNA structure while active would represent a revolutionary advance in our understanding of function in the life sciences. The active regions can be labeled with fluorescent markers and made observable in a fluorescence microscope (Figure 14). Correlative X-ray microscopy of these regions will then be able to reveal the actual structure and conformation of the chromatin fibers in these active regions with a resolution of 25 nm (at present). Some improvement can be made with improved optics, but higher-resolution detail in the sub-10-nm region can be obtained only with sources delivering high average brilliance.

7. METALS AND METALLO-ENZYMES IN LIFE, DISEASE, AND THE ENVIRONMENT

Without trace elements and metallo-enzymes, there would be no life. To understand the biological significance of trace elements, especially metals, in health, disease, and the environment, it is important to determine their role as active components of proteins and macromolecular complexes, including their chemical state and dynamics in the environment of cells and tissues.

Important first steps toward the high-resolution mapping of trace elements have been taken at third-generation light sources, but restrictions in source brightness have made the process too slow to make a major impact and have limited resolution in many cases.

Application: 3-D Imaging and Spectroscopy of the Enzyme Chemistry in Cells and Tissues

X-ray fluorescence coupled with X-ray absorption spectroscopy techniques offers superb trace-element sensitivity and the ability to determine chemical speciation and local electronic and geometric structure of metal constituents in biological systems. The approach to the highest spatial resolutions involves a hard X-ray nanoprobe with tunable excitation energy. The specimen is prepared in frozen, hydrated form and mechanically scanned to acquire a 3-D tomographic dataset using both phase-contrast imaging in

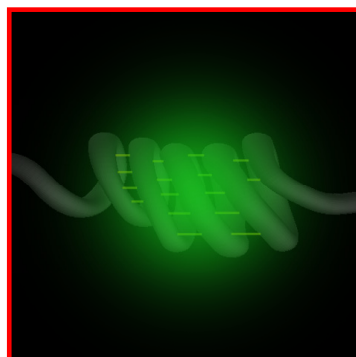
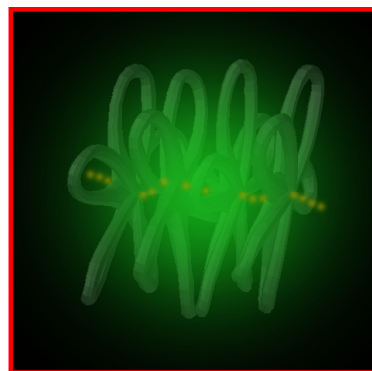

Figure 14 Packaging of DNA. The DNA helix is wrapped around nucleosomes that aggregate to form a “supercoil.” How this is further compacted to form chromosomes is currently not understood but should be revealed by future light sources. (Source: G. Schneider (Bessy, HZB) and J. McNally (NIH))

transmission and fluorescence detection (Figure 15). Chemical state sensitivity is achieved by tuning the photon energy for excitation. High-average-brightness X-ray sources are required to bring this technique to the forefront of metal toxicology, pharmacology, and physiology. This will also enable the study of metal-containing systems at *in vivo* concentrations and under conditions where they are actually undergoing reactions and changes in the sub-millisecond time domain.

In all areas of life science and soft matter research with X-rays, radiation damage is a critical limitation. In moving to higher resolution, smaller samples, and higher sensitivity, more care must be taken in the design of the experiment to make sure that the information collected is not compromised. There is considerable effort going into understanding these issues and finding mitigation strategies. In some cases, making the exposure at cryogenic temperatures is sufficient. In other cases, a useful approach is to continually refresh samples, using nanofluidics, a stream of molecules, or droplets.



Figure 15 3-D tomographic reconstruction of frozen hydrated specimens of *Schizosaccharomyces pombe* at different stages of the cell cycle. Currently, this technique is limited to 30–50-nm resolution due to existing X-ray optics (image courtesy of Carolyn Larabell, National Center for X-ray Tomography).

8. QUANTUM CONCEPTS: CONTROLLING THE MOTION OF INDIVIDUAL ELECTRONS

The conversion of energy in physical, chemical, and biological systems is ultimately governed by the flow of electrons, often by a single electron in an atomic or molecular assembly. The time scales of electron-electron and electron-ion correlations are very short, and their thorough characterization is beyond the reach of present-day light sources.

The ability to experimentally observe the dynamics of electrons for natural length and time scales with powerful attosecond and femtosecond pulses in the ultraviolet and X-ray regime will reveal how correlated electronic motion determines the properties of matter. These dynamics are also at the heart of all light harvesting, photochemical, or photovoltaic processes. The grand aspiration is to find more efficient and economical ways of harvesting sunlight to produce electrical or chemical forms of energy for a secure and sustainable energy supply. Experiments that probe and manipulate electronic dynamics on this natural time scale, on the order of a hundred attoseconds, are fundamental to this task. These studies must necessarily be correlated with investigations that probe the chemical state and atomic motion on the time scale of femtoseconds to picoseconds. Time resolution, on multiple time scales appropriate for electronic to nuclear motion, is the central quality of the tools required to meet this challenge.

Application: Manipulation and Control of the Correlated Motion of Electrons

While there have been recent major breakthroughs based on the technology of high harmonic generation to produce attosecond pulses in the ultraviolet and soft X-ray regions of the spectrum, the low intensity of

these laser-based attosecond sources, $\sim 10^4$ – 10^5 photons/pulse, severely limits the types of experiments that can be performed. A new generation of intense, tunable ultrashort pulses of ultraviolet and soft X-ray radiation has important scientific and technological consequences for this area of science. The essential idea in these experiments is to catch electrons “in the act” as they transition between electronic states triggered by an attosecond light pulse. Typically, in these experiments, a first sub-femtosecond pulse pumps an atom or molecule into an excited state, and then a second pulse probes the excited state by ionizing or double-ionizing the target. These experiments will make use of momentum-imaging detection of the electrons and ions produced in coincidence to give a complete momentum map of the final state, in which the signatures of correlation of the initially pumped metastable state and its decay are recorded as a function of the pump-probe delay (Figure 16). Experiments such as these will push the limits of high peak brilliance and time structure of light sources, since they require intense, tunable sub-femtosecond pulses in the VUV to soft X-ray range at high repetition rates, synchronized with other sources (such as lasers).

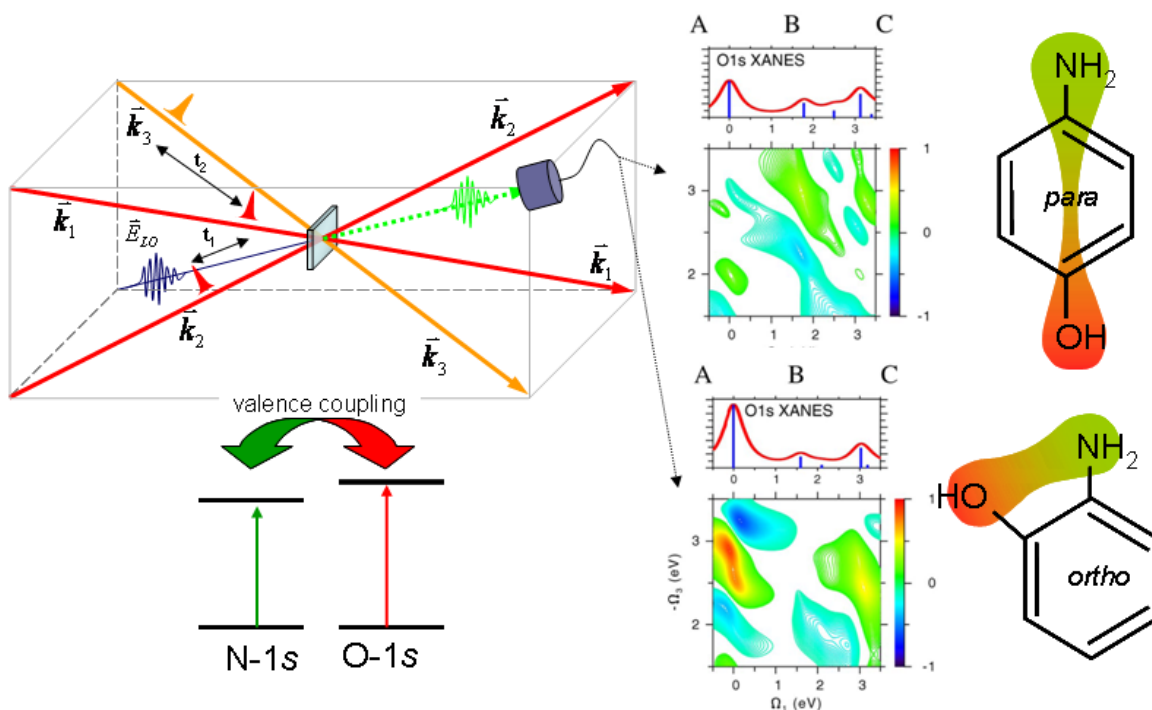

Figure 16 Proposed four-wave mixing of ultrashort X-ray pulses resonant with the oxygen-1s and nitrogen-1s levels that would provide multidimensional images of electron-electron correlations. This experiment would require a higher-intensity X-ray source than is currently available. I.V. Schweigert and S. Mukamel, Phys. Rev. Lett. **99**, 163001 (2007).

9. SYNERGY BETWEEN EXPERIMENT AND THEORY

There is a compelling need for theory associated with fourth-generation light sources, both for motivating and leading new experiments and for explaining the novel phenomena that will be discovered in ultrafast and ultra-intense photon environments. The essential role of theory has been elaborated in Section V of the BESAC report, *Opportunities for Discovery: Theory and Computation in Basic Energy Sciences* [1]. Theoretical studies help determine the designs and specifications of the experiments themselves, particularly when they explore new physical phenomena in ultra-brilliant and ultrafast photon regimes. With the terabytes of data being generated or anticipated from many modern experiments, a serious in-house computational capability is essential. Theoretical and computational programs coupled to experimental research should be incorporated in the plans for new facilities from the outset, as is the practice in high energy physics.

There are several specific roles that theory and computation should play. First, to accommodate its burgeoning computational needs, photon science is on the threshold of a major change in its approach to computing. Such issues as source-detector-data analysis integration, data archiving, and public access will have to be reconsidered in this new era. Fourth-generation sources, for instance, will be able to obtain atomic resolution images of single macromolecules in real time by capturing many 2-D diffraction patterns of a given target sample from many different angular orientations, and then numerically reconstructing the 3-D structure from the patterns. The need to obtain full 3-D information may require 10^5 – 10^6 diffraction patterns to be collected from a series of identical particles, corresponding to tens of terabytes of data. This volume of data could be collected in less than a day's operation, and computing and data-handling resources must be able to keep pace with this generation rate. The growth of the number of photons available and the desired complexity of the imaged structures to billions of resolution elements in space and time will require the development of novel ideas, constant feedback, and interaction between computational and experimental scientists to push the limits of imaging techniques. In particular, there is a pressing need to develop advanced numerical algorithms to deal with the large, complex data sets generated by existing and future light sources.

Second, with the large amounts of data being produced at modern light sources, unified pictures and simple interpretations of the data are often missing. Without theory as a guide, the true nature of these systems may remain hidden or perhaps even be misrepresented. At the same time, improvements in computational methods and architectures enable detailed numerical studies of spectral features revealed, for example, by angle-resolved photoemission spectroscopy and resonant inelastic X-ray spectroscopy. With increases in memory capacity, clock speed, and networking techniques, highly accurate simulations of photon-based spectroscopies can be carried out in parallel on shared-memory machines that quantitatively describe measured spectra. Combined with close experimental collaboration, these unique advances offer unrivaled quantitative insight into ultrafast phenomena in complex atomic and molecular architectures. To realize these insights widely across the scattering-science community requires developing and maintaining community software codes targeted to the forefront experiments at photon science facilities, as well as making such codes readily accessible to experimentalists and theorists.

Finally, the role of pure theory cannot be overemphasized. New theoretical concepts not only play a fundamental role in explaining existing data, but they also are instrumental in suggesting novel experiments that probe unexplored phenomena. The search for new phenomena motivated by theoretical suggestions drives much of the development of new photon sources and the experiments they enable. In that context, the strong integration of theory and experiment, like that already established in high energy physics facilities, is a worthy goal to strive for at future BES photon sources.

10. PHOTON ATTRIBUTES FOR SCIENCE DRIVERS

The correlation matrix below outlines the photon attributes required to realize the science drivers presented in this report.

Table 1 Correlation Matrix: Science Beyond Third-Generation Light Sources

Science Opportunities	Photon Attributes						
	Coherence	Brilliance (average)	Spatial Resolution (<1 nm)	Time Resolution (<1 ps)	Peak Brilliance	Energy Resolution	Polarization (circular, linear)
Nanoparticle spectroscopy for solar cells	Nano-XPS		Charge-carrier dynamics spectroscopy				
Charge-transfer dynamics in photosynthesis			Scattering and spectroscopy to identify and control individual steps				
Battery stress and degradation	Functional imaging and spectroscopy					X	
Magnetic quantum dot materials			Imaging femtosecond magnetization dynamics				X
Understanding and development of novel superconductors		Spatially resolved electronic characterization Nano-ARPES, RIXS				X	
Chemistry at the surface of mineral particles	Imaging structure and function of mineral particles in a wet environment					X	
Catalysis and chemistry		Monitor catalysts with atomic resolution under process conditions		“Movies of a chemical reaction,” femtosecond spectroscopy and scattering			
Life sciences		Flash imaging of function at the cellular level					
	3-D mapping of DNA conformations Imaging and spectroscopy of enzyme chemistry					X	X
Nano-materials	X	EXAFs of clusters			Spectroscopic characterization and imaging of individual clusters		
Quantum control				Resolving and controlling electron dynamics			
Extreme environments				X-ray imaging of plasma processes			

Reference

1. *Opportunities for Discovery: Theory and Computation in Basic Energy Sciences*, Subcommittee on Theory and Computation of the Basic Energy Sciences Advisory Committee (BESAC), U.S. Department of Energy, January 2005, <http://www.sc.doe.gov/BES/reports/abstracts.html>.

4. CROSS-CUTTING CHALLENGES

In the previous chapter, key energy science challenges and the photon attributes required to meet them were discussed. In order to convey the breadth of experiments enabled by next-generation light sources, this chapter describes the opportunities through a set of cross-cutting themes. Chapter 3 and Appendix 2 provide greater detail on the themes presented here. The opportunities for future photon sources can be divided into five cross-cutting challenges that fall into three groups, as summarized in Table 2 and elaborated below.

Table 2 Five Cross-cutting Scientific Challenges that Require Next-generation Light Sources

Group	Cross-Cutting Challenges
1	4.1 <i>Control of Complex Materials and Chemical Processes</i>
2	4.2. <i>Real Time Evolution of Chemical Reactions, Motion of Electrons and Spin</i> 4.3. <i>Imaging and Spectroscopy of Individual Nano Objects</i>
3	4.4. <i>Statistical Laws of Complex Systems</i> 4.5. <i>Simultaneous Ultrashort and Ultrafast Measurements</i>

The first group, consisting of Challenge 4.1 in Table 2, extends techniques and applications of synchrotron radiation to environments that are inaccessible to present-day light sources due to insufficient intensity or brightness (for example, *in situ* measurements under realistic catalysis conditions). The four-orders-of-magnitude increase in brightness of next-generation light sources opens whole new fields of materials behavior and chemical change to investigation by photon scattering.

The second group, comprising Challenges 4.2 and 4.3 in Table 2, exploits the short pulse lengths and high coherence of the photon beam to probe the ultrafast femtosecond time scales and few-nanometer spatial scales, revealing previously hidden dynamics of the energy spectra and three-dimensional spatial structure of complex materials and phenomena. Taken together, these two challenges explore the ultrafast dynamics and spectroscopy of small objects where quantum behavior dominates.

The third group, comprising Challenges 4.4 and 4.5 in Table 2, poses some of the most demanding and rewarding opportunities of fourth-generation photon sources. Challenge 4.4 presents an intellectual challenge, finding the laws that govern the collective behavior of complex systems by using the power of coherent beams to image simultaneously the behavior of each constituent of an interacting ensemble. Using the ultrafast time structure of fourth-generation light sources, Challenge 4.4 probes the collective behavior of interacting ensembles down to femtosecond time scales. Challenge 4.5 requires the most aggressive light source design, combining the ultrafast time resolution of Challenge 4.2 with the diffraction-limited spatial resolution of Challenge 4.3 to push the fundamental limits of spatial and temporal resolution. Such measurements carry the risk of altering or destroying the measurement object due to the high photon flux density.

1. CONTROL OF COMPLEX MATERIALS AND CHEMICAL PROCESSES

The report *New Science for a Secure and Sustainable Energy Future* [1] outlines the range of transformational new materials that will be required to produce, store, distribute, and utilize sustainable energy. These materials must be controllable on the atomic scale, and their electronic and mechanical

properties must be tunable. They must also be highly functional — for example, carrying out the conversion of a photon into an electron in a solar cell, the reverse conversion of an electron into a photon in solid state lighting, or the conversion of energy in chemical bonds into electrons via an electrocatalyst for fuel cells.

These complex phenomena often comprise several interlocking steps that occur in neighboring molecular or electronic environments at ultrafast time scales. Observing and controlling such phenomena requires spatial, temporal, and energy resolution beyond the reach of third-generation synchrotrons. With orders of magnitude more brilliance, fourth-generation sources will be able to probe, for the first time, electronic and molecular phenomena that involve much smaller numbers of atoms and electrons. High beam coherence up to hard X-ray energies dramatically increases the spatial resolution of imaging, and femtosecond pulse width captures the fast dynamics of molecular energy conversion phenomena. These capabilities to observe electronic and molecular energy-conversion phenomena on their natural length and time scales are essential to understanding and ultimately controlling the materials and chemistry of next-generation sustainable energy technology.

Understanding is the critical first step in controlling sustainable energy materials, but understanding alone is not enough. Controlling conversion phenomena requires tuning the atomic and molecular structures of materials to increase efficiency and to couple multiple steps in the energy-conversion chain, such as the intermediate steps in a sequence of catalyzed chemical reactions or the transfer of a cation from a battery electrode to an electrolyte. Once the principles governing these phenomena are understood, complex materials architectures must be synthesized to implement and optimize the targeted function. This requires new approaches to materials synthesis, often involving elaborate control of temperature and pressure gradients, complex chemical environments, and multiple material constituents. There must be a close coupling of materials synthesis and characterization experiments at light sources where the ability of the synthesized materials to control electronic and molecular energy conversion can be evaluated. Fast turnaround is critical: materials synthesized one day must be evaluated in the light source the next day. In many cases, synthesis itself needs to be carried out *in situ* at the light source, so that the growth modes of the crystal, film, or macromolecular assembly can be observed and tuned to learn how to optimize the composition, structure, and architecture that controls function. This close coupling of synthesis and light source characterization requires establishing new modes of facility operation that go well beyond the traditional application-approval model with its months-long turnaround times.

Beyond synthesis, understanding the performance limitations of the complex materials of sustainable energy conversion often requires sophisticated *in situ* experiments. The study of well-defined chemical reactions on single-crystal surfaces must be supplemented with experiments on realistic, supported catalysts inside a nano-structured matrix; these often require high pressure and high temperature to become catalytically active. High-capacity batteries experience a dramatic volume change with each charge-discharge cycle, which eventually destroys the battery electrodes by sheer mechanical stress. To overcome this difficulty, one option being considered is a composite of rigid nanoparticles in a soft matrix—a nano-structured composite whose performance must be characterized *in situ* at a light source. The current density in semiconductor electronics has been pushed to the electromigration limit, where the “electron wind” actually moves atoms around. Organic conductors in photovoltaics and solid-state lighting are even more susceptible to degradation at high current densities, and their failure mechanisms are completely different from those of inorganic metals and semiconductors. The nature of these performance barriers needs to be observed, understood, and controlled with *in situ* experiments at fourth-generation light sources.

The need for higher spatial resolution of catalytic reactions is illustrated in Figure 17, showing one of the Fischer-Tropsch reactions that convert coal to liquid fuel that could replace gasoline produced from oil. The Fischer-Tropsch process, used in Germany during World War II to produce fuel from coal and now

used in South Africa, is an alternative to imported oil, but still too expensive in its present form for widespread use. New catalysts are the key to making Fischer-Tropsch chemistry cost-competitive and cleaner. Experiments with high spatial and temporal resolution at fourth-generation light sources are needed to understand, control, and design these new, more effective catalysts.

Correlated electron materials, such as high-temperature superconductors and transition metal magnets, defy traditional explanations in terms of one-electron theory. Angle-resolved photoemission is a powerful technique for characterizing the electronic structure of these materials; however, it must be combined with other probes, such as inelastic X-ray scattering, to explore the two-electron correlations in detail. Inelastic X-ray scattering measures the structure factor for *charge* excitations, complementary to the structure factor for *magnetic* excitations that is obtained by inelastic neutron scattering at neutron sources.

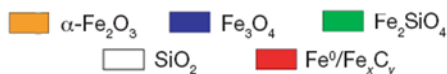
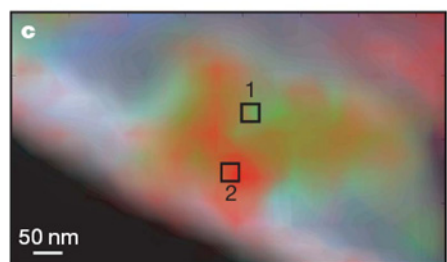
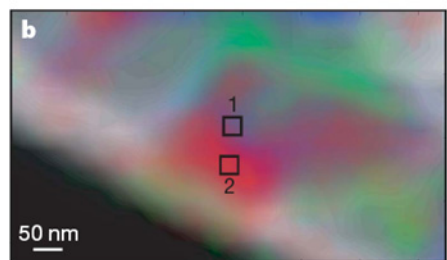
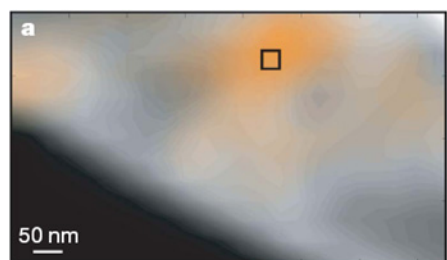

Figure 17 Observation of catalytic reactions under realistic conditions: Chemical images of a real catalyst are obtained at various steps of the Fischer-Tropsch process, which converts abundant coal to liquid fuel as a replacement for gasoline produced from oil. With the resolution of tens of nanometers obtainable at state-of-the-art synchrotron light sources, one can clearly detect local chemical reactions that change the oxidation state of iron near the catalytic iron particles. However, to get down to the sub-nanometer resolution required for understanding the catalytic process on an atomistic level requires next-generation light sources and microscopes. From E. de Smit, I. Swart, J.F. Creemer, G.H. Hoveling, M.K. Gilles, T. Tyliczszak, P.J. Kooyman, H.W. Zandbergen, C. Morin, B.M. Weckhuysen, and F.M.F. de Groot, *Nanoscale chemical imaging of a working catalyst by scanning transmission X-ray microscopy*, Nature **456**, 222 (2008).

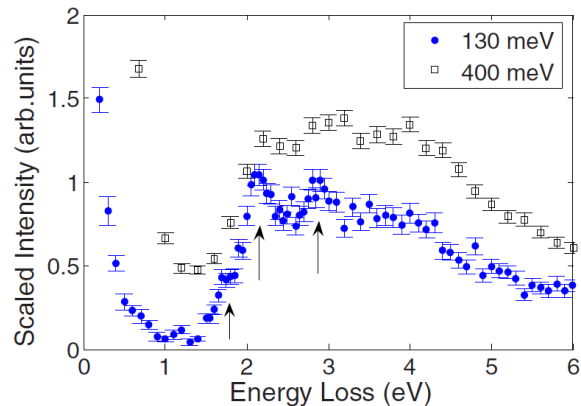

Figure 18 Resonant inelastic X-ray scattering (RIXS) from the parent compound of a high-temperature superconductor: Characteristic energy transfers $\hbar\omega$ can be observed in the 2–4-eV range that represent electronic excitations. While the improvement of the resolution from 400 meV to 130 meV (the current state of the art) reveals new features, a much better energy resolution would be required to get down to the energy scale of ≤ 40 meV that is relevant for the pairing of electrons in high-temperature superconductors. A light source with much higher brightness than currently available will be required for that. From D.S. Ellis, J.P. Hill, S. Wakimoto, R.J. Birgeneau, D. Casa, T. Gog, and Young-June Kim, *Charge-transfer exciton in La_2CuO_4 probed with resonant inelastic X-ray scattering*, Phys. Rev. B **77**, 060501R (2008).

A limitation of inelastic X-ray scattering is its extremely low cross section, as demonstrated in Figure 18. Existing light sources do not have enough brightness to enable the millielectron-volt energy resolution that is required to examine the charge excitations of superconductors and other electronic materials. Resolution much better than the thermal energy scale $k_B T$ of 25 meV at room temperature, and at least three times lower for superconductors, must be achieved. With higher energy resolution, inelastic X-ray scattering could probe the excitations that drive pair formation in high-temperature superconductors. A magnetic excitation observed in cuprates at about 40 meV by neutron scattering is a potential candidate for the pairing excitation. Inelastic X-ray scattering at fourth-generation light sources would provide crucial insights into this and other excitations that govern superconducting pairing correlations.

2. REAL-TIME EVOLUTION OF CHEMICAL REACTIONS, MOTION OF ELECTRONS, AND SPINS

Observing chemical reactions in real time, a cherished scientific dream, is a difficult challenge because of the short time scales on which atoms move, typically 10-100 fs. Synchrotron-based ultraviolet and X-ray sources operate with pulses in the picosecond to nanosecond regime, too slow to image most sustainable energy-conversion reactions but fast enough for relatively slow biochemical reactions, as shown in Figure 19. A fast visible laser pulse triggers a biochemical reaction, and the evolution of the protein structure is probed at various delay times using X-ray crystallography. This example shows desorption and re-adsorption of carbon monoxide by myoglobin, the oxygen-bearing protein in tissue and a relative of hemoglobin, the blood-borne protein that carries oxygen throughout the body.

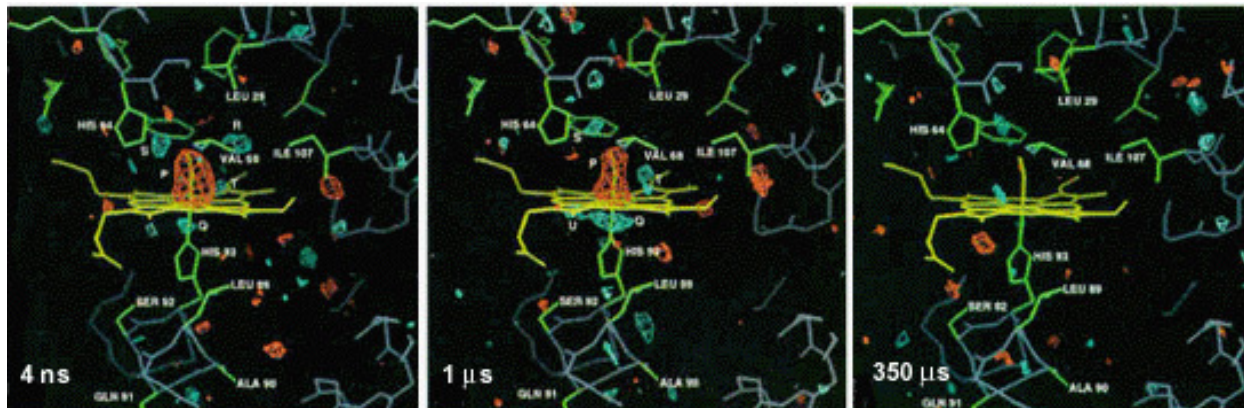

Figure 19 Time evolution of a protein structure after applying a chemical stimulus with a femtosecond pump pulse. Difference Fourier maps of carbonmonoxy myoglobin at room temperature reveal photolysis of the carbon monoxide ligand (red, negative difference density) from the heme iron 4 ns after a myoglobin crystal receives a laser pulse. Subsequent loss of this negative difference feature at 1 μ s and 350 μ s indicates ligand rebinding to the heme. The initial photolysis step cannot be observed with the time resolution available at present light sources. (From the Moffat Lab: <http://moffat.bsd.uchicago.edu/>.)

Results like these inspire dreams of producing movies of proteins in action, as well as of the much faster catalytic reactions that govern chemical energy conversion. Laser-like X-ray sources with femtosecond pulse widths at fourth-generation light sources could make this possible.

The mechanism of photosynthesis in nature is the model for artificial photosynthetic processes that convert water and carbon dioxide to fuel. Despite decades of study and remarkable progress in revealing structure, the dynamics of the water-splitting protein complex photosystem II still harbors essential mysteries. The water-splitting process, one of the most energetically challenging in nature, involves a complex sequence of steps with time scales ranging from 100 fs to 30 ps. This process dynamics would become accessible using the ultrashort pulse width and high peak brilliance of next-generation X-ray sources. Imaging the photo-induced electron dynamics in natural light-harvesting systems would provide key information for controlling the transformation of photon energy into electron energy or chemical energy in sustainable energy systems of the future.

Even more difficult than following the motion of atoms is keeping track of electrons, which move a thousand times faster at the same kinetic energy. Typical Fermi velocities of electrons in metals are about a nanometer per femtosecond. To follow the motion of electrons in nano-structured materials would require femtosecond time resolution. For example, one could consider the temporal evolution of charge transfer in solar cells to find out when and where charge carriers are lost. Similarly, the efficiency of light-emitting diodes in solid-state lighting is directly affected by the loss of charge carriers and could be followed with femtosecond time resolution at next-generation photon sources.

Speed is one of the most important factors in microelectronics. While the charge switching of electrons is rather well understood, the magnetic switching of spins in spintronic materials is under intense scrutiny. From the small energies involved in the spin-orbit interaction, one would expect a rather slow switching time for spins. Nevertheless, switching times in the femtosecond regime have been observed by pump-probe techniques combining a laser and synchrotron radiation. Figure 20 shows results for ferromagnetic Ni. Such experiments clearly demonstrate that spin angular momentum is transferred to the lattice, even on ultrafast time scales. While in Figure 20 the ferromagnetic moment is quenched to zero, experiments with polarized laser excitation [2] demonstrate that a complete reversal of the spin is

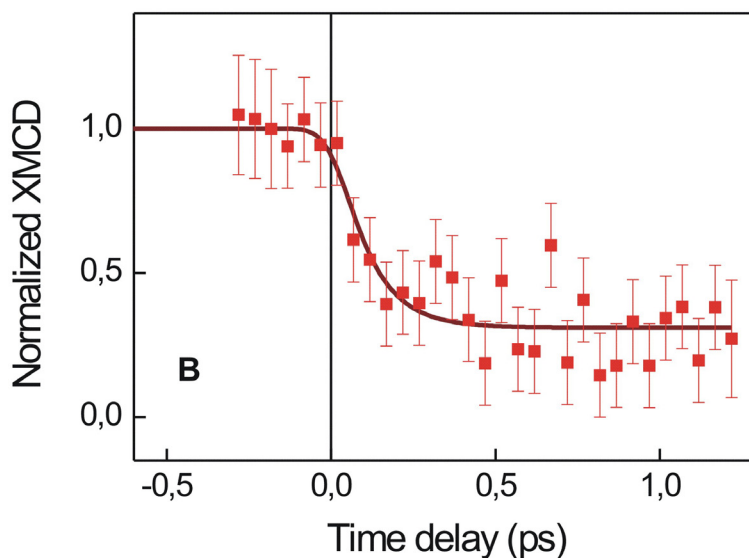
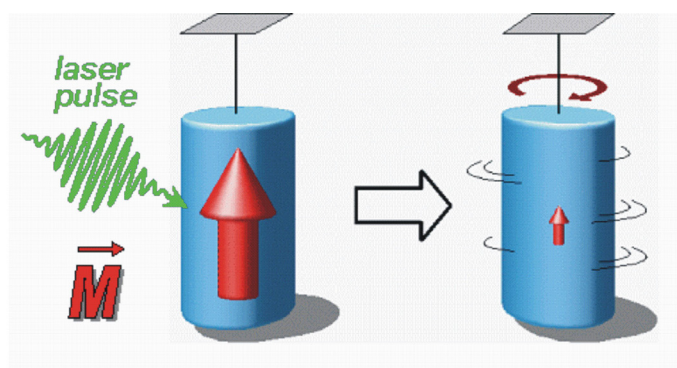

Figure 20 Femtosecond temporal evolution of the Ni magnetic moment following optical laser excitation. Bottom: Time delay scan of the magnetic dichroism at the Ni L_3 edge, representing the Ni $3d$ magnetic moment. The signal drops within the first 500 fs, implying that angular momentum is dissipated out of the Ni $3d$ valence shell and somehow transferred to the lattice. Top: Schematic illustration of a time-resolved analogue to the Einstein-de-Haas effect. Laser-induced quenching of the ferromagnetic order changes the spin angular momentum. Angular momentum conservation would require that a suspended ferromagnet would start to rotate. It remains a challenge for future light sources to directly detect such an effect. [From C. Stamm, T. Kachel, N. Pontius, R. Mitzner, T. Quast, K. Holldack, S. Khan, C. Lupulescu, H.A. Dürr, W. Eberhardt, *Femtosecond modification of electron localization and exchange of angular momentum in Ni*, *Nature Materials* **6**, 740 (2007).]

possible. One or more new, not-yet-understood mechanisms must be at work. Speculations range from phonon-enhanced spin-orbit coupling to novel states of matter formed during optical laser excitation. Such experiments, which are a *tour-de-force* with currently available light sources, would become mainstream at fourth-generation light sources.

A typical pump-probe NEXAFS time-resolved measurement is shown in Figure 21. From such measurements on the 100-ps time scale, one can begin to extract important information about spin excitations and their lifetimes. At present sources, reaching the 100-fs time scale characteristic of structural dynamics requires heroic proof-of-principle experiments that exploit a special time-slicing setup and require extremely long data-taking times. Extending these heroic measurements to the few-femtosecond regime characteristic of electronic excitations is impossible at today's light sources. The fast time resolution of fourth-generation sources, however, would put these measurements well within reach.

The magnetism of 3d transition metals and 4f rare earths is key to the operation of many magnetic materials, catalysts, and metallo-proteins. Their magnetic states are probed by photoexcitation of core electrons in the 500–1,500-eV energy range, such as the Fe 2p level shown in Figure 21. Highly dilute solutions of important metallo-proteins, such as the Fe-containing heme or the Mn-containing photosystem II, provide small spectroscopic signals. New, ultrafast, tunable X-ray sources are required to directly probe the excitation of 3d and 4f levels with suitable sensitivity. Transition metals are important not only for magnetism, but also for catalysis. An example is the Haber-Bosch ammonia synthesis, which is the key for producing fertilizer and consumes significant energy in the process. It uses an iron-based catalyst, while nature's way of fixing nitrogen, the enzyme nitrogenase, uses a Fe₆Mo-cofactor active site. Fourth-generation sources are needed to understand and ultimately control, modify, and adapt the elementary steps in these catalytic processes to sustainable energy-conversion materials.

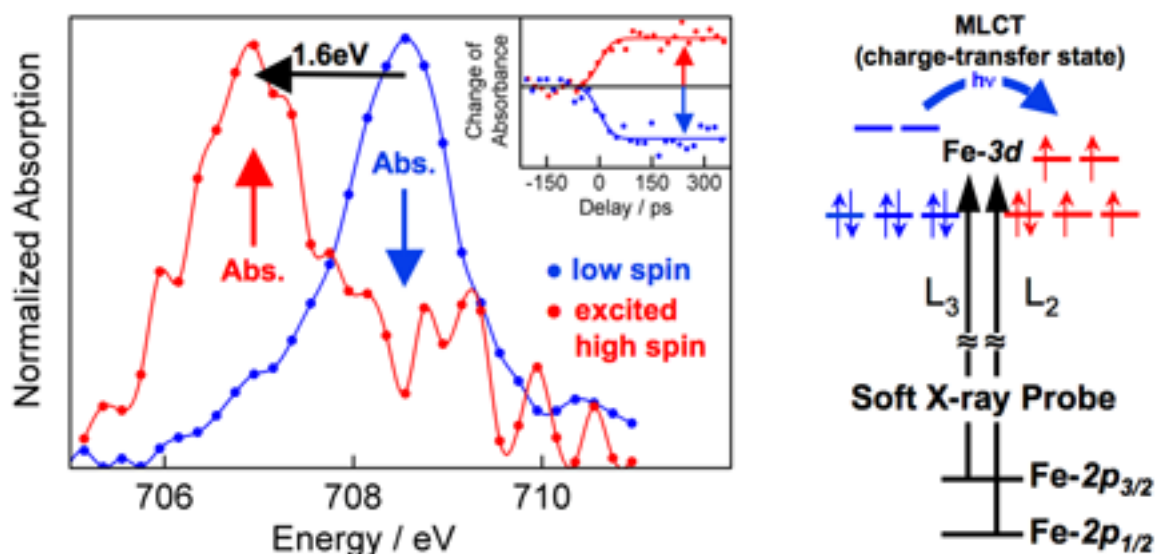

Figure 21 A pump-probe NEXAFS spectrum revealing a change in the electronic structure of an organometallic molecule on a picosecond time scale: Left: Absorption spectra of the Fe(II) L₃ edge for the ground state with low-spin (blue) and excited high-spin states (red) at 5-ns delay. Inset: Time delay scans at the absorption maxima of the low- and high-spin states. Right: Simplified level scheme and the soft X-ray probe transition. Solvated transition-metal complexes, such as that studied here, are of fundamental interest for artificial photosynthesis, heme proteins, and opto-magnetic data storage, due to their strong interaction between electronic and molecular structure. To reach the intrinsic femtosecond time scale for electronic excitations requires a new generation of light sources. From Nils Huse and Robert Schoenlein, *ALS News* Vol. **292**, October 29, 2008.

3. IMAGING AND SPECTROSCOPY OF INDIVIDUAL NANO OBJECTS

Nanotechnology often involves self-assembled objects with single-digit nanometer dimensions, such as nanoparticles in solar cells and batteries, quantum dots in semiconductor electronics, and metallic clusters in heterogeneous catalysis. The size and shape distributions of these objects are a fundamental problem, because they broaden the spectrum of energy levels and make catalysts less controllable. It is highly desirable to eliminate this problem by probing the true properties of an isolated nano object. The reconstruction of a single nano object from coherent X-ray diffraction has become a highly active field of research in recent years. It provides a new way to look at the structure of individual nano objects, such as nanocrystals, cells, viruses, and possibly proteins, with next-generation X-ray light sources. Diffractive or lensless imaging of a gold nanocrystal has been demonstrated with partially coherent X-rays from a

storage ring [3]. However, to get down to atomic resolution will require a far more coherent and brilliant light source.

Figure 22 shows an example of lensless coherent imaging from the soft X-ray region, where chemical imaging is possible using resonant diffraction at the C1s, N1s, and O1s absorption edges. Recent work at the ultraviolet FEL FLASH in Germany demonstrates that lensless images can be captured with a single femtosecond pulse [4]. The intense photon beam ultimately converts the object to a high-temperature plasma, but the diffraction pattern is recorded before the constituent atoms have a chance to move far enough to blur the image at the ~ 60 -nm resolution of the experiment. In many cases, one wants a full three-dimensional image to learn about the architecture of the object. This requires 3-D diffraction data, setting higher requirements on the coherence of the source. This form of imaging has been demonstrated in a few cases [5] requiring a day or more to collect the data at third-generation storage rings. For routine imaging, fourth-generation sources with higher coherence will be necessary.

A novel approach to coherent imaging uses photoelectrons excited by X-rays. A first attempt in this direction appears promising, as shown in Figure 23 [6]. The wave functions of electrons confined to a terrace at a stepped surface can be retrieved from their photoelectron diffraction pattern by methods similar to coherent X-ray imaging, such as over-sampling and iterative phase retrieval. By setting the energy of the spectrometer to the three lowest quantum well states on a terrace and mapping the intensity distribution in k -space, three different wave functions are obtained. Implementing methods such as this at fourth-generation sources would dramatically expand the range of valence electron wavefunctions and phenomena that can be accessed.

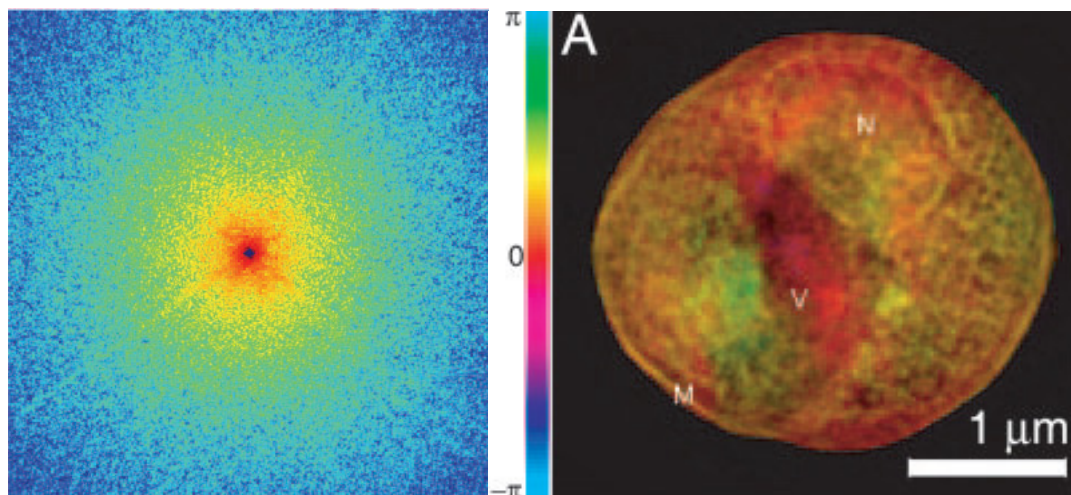

Figure 22 Coherent diffraction from a yeast cell, demonstrating lensless imaging. The diffraction pattern is shown on the left; the reconstruction, on the right. A more coherent light source is required to extend this type of imaging from the micrometer down to the nanometer regime. From David Shapiro, Pierre Thibault, Tobias Beetz, Veit Elser, Malcolm Howells, Chris Jacobsen, Janos Kirz, Enju Lima, Huijie Miao, Aaron M. Neiman, and David Sayre, *Biological imaging by soft X-ray diffraction microscopy*, PNAS **102**, 15343 (2005).

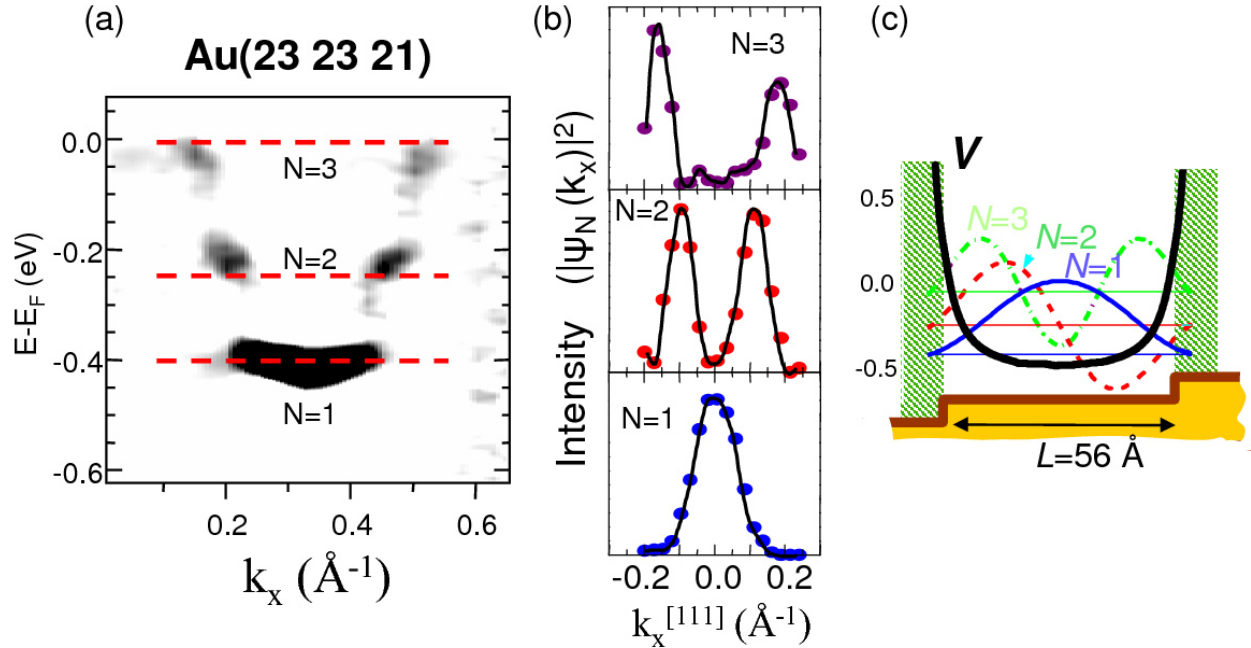

Figure 23 Obtaining the wave function of electrons in a nano object (right) from the angular distribution of their photoemission pattern (left and center): Iterative reconstruction techniques are used to retrieve the wave functions of three quantum well states confined to a 5.6-nm-wide terrace at a stepped gold surface. The method is analogous to lensless imaging with X-rays, but applied to electrons. [From A. Mugarza, J.E. Ortega, F.J. Himpsel, and F.J. García de Abajo, *Measurement of electron wave functions and confining potentials via photoemission*, Phys. Rev. B **67**, 081404 [R] (2003).]

In addition to atomic structure, the electronic structure of a nano object can be explored using spectroscopy. Nano-sized grains or crystals are often the largest samples available for novel materials, such as high-temperature superconductors, complex oxides, f-electron compounds, and multiferroics. When large samples exist, their composition, atomic structure, and electronic structure often vary on nanometer length scales due to dopant or alloy distribution fluctuation, or spontaneous quantum phase separation driven by competing order parameters. Even in perfect single crystals, the electronic structure can vary within a single unit cell due to intrinsic structural features; the occurrence of two-dimensional CuO_2 planes and one-dimensional CuO chains in the $\text{YBa}_2\text{Cu}_4\text{O}_8$ high-temperature superconductor is a good example [7]. These spatial variations can be key features of the functionality of these materials. The length scales of interest can vary from tens of micrometers to nanometers, and a tightly controlled probe size is essential for uncovering the spatial modulation and its consequences. Attempts at existing light sources to restrict the beam in angle-resolved photoemission to micrometer sizes already show that important local information can be revealed. The high coherence of fourth-generation light sources would enable focusing the beam to nanometer spot sizes, exposing a wealth of intrinsic disorder, nano-phase separation, and quantum confinement effects that are now beyond reach.

Eventually, it would be desirable to push toward spectroscopy of a single nano object. How much spatial resolution is required to achieve this goal? As Figure 24 shows, a spot size on the micrometer scale restricts the broadening induced by the size distribution of self-assembled quantum dots significantly, allowing the first signs of sharp energy levels to appear out of a broad background. Producing nanometer spot sizes routinely, however, requires the coherence and brilliance of a fourth-generation source.

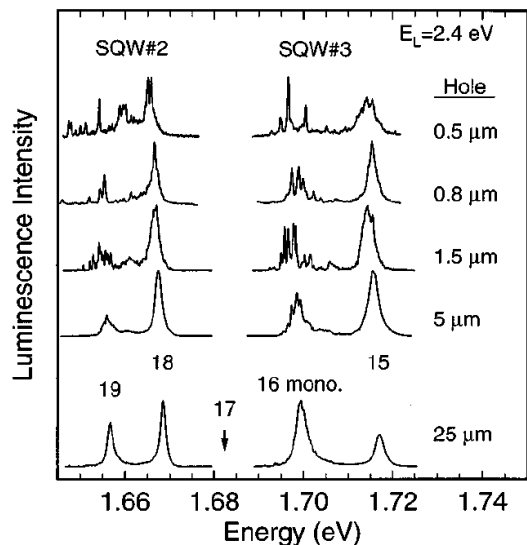

Figure 24 Toward spectroscopy of a single nano object. The energy levels in an array of self-assembled semiconductor quantum dots are probed by laser spectroscopy. The size distribution of the dots smears the spectra into broad peaks. Using a small aperture reduces the number of dots that are sampled and thereby leads to sharper spectra. The ultimate goal is a spectrum from a single quantum dot. The spectrum of such an “artificial atom” consists of a characteristic pattern of δ -functions. [From Gammon et al., *Appl. Phys. Lett.* **67**, 2391 (1995).]

Instead of focusing on a single nano object, one can perform spectroscopy on an ensemble of identical clusters that has been precisely mass-selected. Although possible, this creates an enormous loss of signal; the density of a mass-selected atomic cluster beam is comparable to that of the residual gas in a vacuum chamber. Nevertheless, with high-powered conventional lasers it is possible to probe the energy levels around the fundamental band gap of atomic clusters, as shown in Figure 25. Deeper levels are not accessible with conventional lasers and require a high intensity of deep ultraviolet photons from fourth-generation light sources.

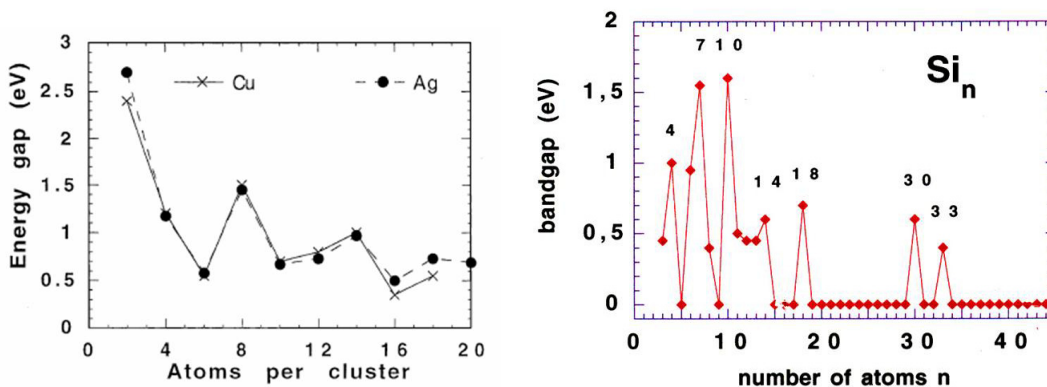

Figure 25 Spectroscopy of isolated nano objects with well-defined atomic structure. The gap between the highest occupied and lowest unoccupied state of mass-selected metal clusters and silicon clusters is determined by conventional laser spectroscopy. New laser-like light sources with higher photon energy are needed to reach deeper occupied states and higher-lying unoccupied states. From H. Handschuh, C.Y. Cha, P.S. Bechthold, G. Ganteför, W. Eberhardt, *J. Chem. Phys.* **102**, 6406 (1995); C.Y. Cha, G. Ganteför, W. Eberhardt, *J. Chem. Phys.* **99**, 6308 (1993); M. Maus, G. Ganteför, W. Eberhardt, *Appl. Phys.* **A 70**, 535 (2000).

4. STATISTICAL LAWS OF COMPLEX SYSTEMS

Complex systems, such as the human brain and the biochemistry of life, are fundamental to advanced functionality. Often, complex systems are composed of large ensembles of simple building blocks, such as neural networks, magnetic domains in thin films, and block copolymer assemblies. The speckle patterns produced by coherent visible light from lasers can simultaneously image each member of a large ensemble of building blocks, such as the magnetic domains shown in Figure 26. The ensemble of magnetic domains is neatly sorted by size and orientation in reciprocal space. The radius of the diffuse ring in Figure 26, for example, provides the average domain size, and the width of the ring provides the size distribution. The speckle pattern provides much more than these average measures, however—each domain is represented by a speckle, allowing the behavior of each individual member of the ensemble to be followed independently. This type of experiment fully utilizes the coherence of a laser beam.

Extending such measurements to shorter wavelengths with fourth-generation light sources allows sampling of smaller building blocks, with soft X-rays probing down to the nanometer scale and hard X-rays extending the range down to atomic dimensions. In Figure 26, the details of the speckle pattern faithfully represent the orientations of all the magnetic domains. By correlating speckle patterns taken at different times, it becomes possible to draw detailed conclusions about how magnetic data-storage media remember their previous state and how they forget after being cycled through a hysteresis loop. This search in the time domain can be extended by many orders of magnitude with pulsed light sources, from many seconds to femtoseconds. This opens a vast region of spatial and temporal frequencies that has remained completely uncharted.

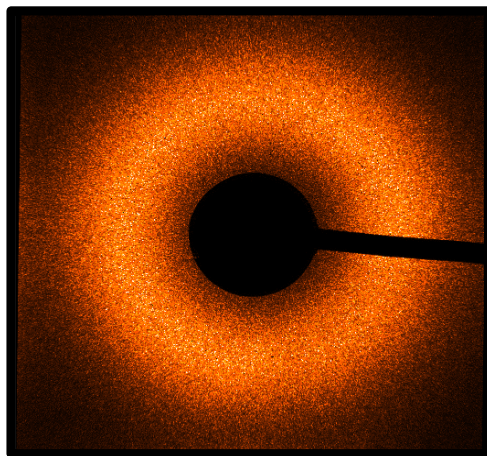

Figure 26 Revealing simple statistical laws of complex systems. The image shows the coherent diffraction pattern (“speckles”) of a magnetic Co:Pt film at $\lambda=1.6$ nm, where a resonant transition from the Co2p to the magnetic Co3d valence states occurs. Coherent diffraction can be combined with time resolution to explore the spatial and temporal behavior of complex systems, such as soft matter and magnetic systems. By extending the coherence and time resolution with new light sources, a vast new region of space-time (or momentum-energy) combinations can be explored. From Michael S. Pierce, Rob G. Moore, Larry B. Sorensen, Stephen D. Kevan, Olav Hellwig, Eric E. Fullerton, and Jeffrey B. Kortright, *Quasistatic X-ray Speckle Metrology of Microscopic Magnetic Return-Point Memory*, Phys. Rev. Lett. **90**, 175502 (2003).

5. SIMULTANEOUS ULTRASHORT AND ULTRAFAST MEASUREMENTS

Advanced electronic devices are often based on quantum effects that occur when electrons are confined to nanometer-scale regions. An example is the ubiquitous quantum well laser, where electrons and holes are confined to a region in the single-digit nanometer regime. By bringing electrons and holes together, such a confinement enhances their probability of recombining and emitting a photon, a liability of solar cells but an advantage for solid-state lighting. Furthermore, the quantization of the electron energy spectrum compresses the density of states into δ -functions, leading to sharp optical transitions with high oscillator strength. Another example is the optimization of solar cells for high efficiency. A key factor limiting the efficiency of inexpensive polycrystalline or nanocrystalline solar cells is the loss of electrons and holes at interfaces, such as grain boundaries. Resolving the loss mechanism on an atomic scale during a short carrier lifetime is a demanding task. More generally, understanding the motion and loss of charge carriers in nanometer-scale structures is a key to advancing nanoscale science and technology. Electronic velocities in solids are typically nanometers per femtosecond. Typical carrier lifetimes of tens of femtoseconds in metals lead to inelastic mean free paths of about 10 nm. This determines the signal propagation behavior of charge transport in conventional integrated circuits.

Even faster signal propagation speeds can occur if light is trapped by electronic excitations. For instance, at noble metal surfaces, surface plasmon polaritons (SPPs) at infrared light frequencies can propagate close to the speed of light. SPPs can also propagate in media with sub-wavelength dimensions, since the electromagnetic field of SPPs is confined to the metal-dielectric interfaces. This makes SPPs promising candidates for use in integrated high-density electro-optical circuits with ultra-broadband data-transmission capabilities. Perhaps one of the best-known examples of such plasmonics applications is the extraordinary optical transmission through sub-wavelength hole arrays [8].

An example of spatio-temporal imaging of SPPs in an Ag wire is shown in Figure 27. Temporal control is achieved by the interference of two 10-fs optical laser pulses with 330-as precision. Laser-emitted photoelectrons are imaged with 50-nm spatial resolution. This state-of-the-art example clearly demonstrates how coherent excitation of collective excitations, as well as their subsequent dephasing in time and space, can be determined with fully coherent light sources and modern imaging techniques. It was recently shown that SPPs can be used to initiate femtosecond spin dynamics on length scales below 60 nm [9]. However, such studies are severely limited by inefficient spin detection. Combining powerful direct magnetic imaging techniques, such as magnetic dichroism [10], with fully coherent femtosecond X-ray pulses would revolutionize this field. Furthermore, SPPs might be the ideal way to control chemical reactions on the nanoscale. Although SPPs can be probed optically, the possibility of induced chemical dynamics requires element-specific femtosecond X-ray probes that are beyond present-day capabilities.

One might imagine eventually pushing the spatial and temporal resolution to the limits given by the atomistic structure of matter and the uncertainty relation, which broadens the energy resolution when decreasing the time resolution. For example, a one-femtosecond-width pulse has an intrinsic energy width of at least 0.3 eV. It has been a long-standing problem to resolve in real time the transfer of electrons in chemical reactions that couples the motion of electrons and nuclei and violates the Born-Oppenheimer approximation. The field of nonlinear X-ray optics, including four-wave mixing in the X-ray regime and other multi-spectral techniques, is still uncharted. Such experiments require a sufficiently high concentration of photon flux in space and time that most samples will be destroyed. Even with extremely sturdy samples, such as atoms or atom clusters, the rapidly rising electric field during a pulse will modify the electronic structure while attempting to probe it. These issues present intriguing intellectual as well as technical challenges that can only be explored with fourth-generation light sources.

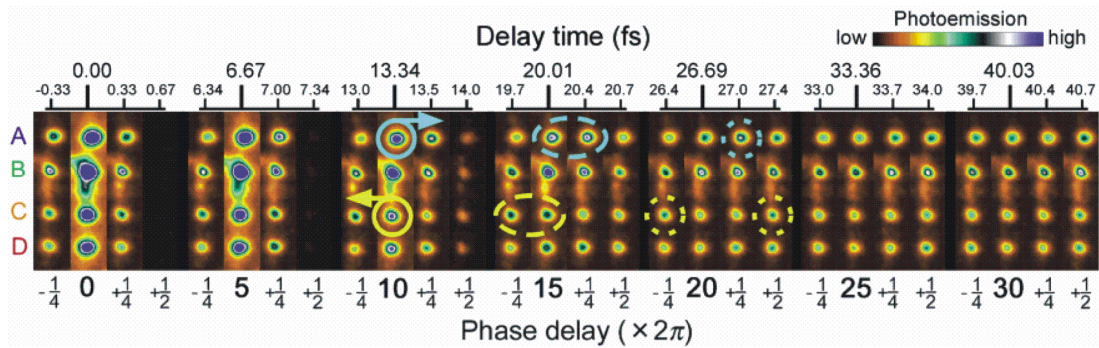

Figure 27 Light interacting with nanostructured metals excites the collective charge-density fluctuations known as surface plasmon polaritons (SPPs). Incident light is trapped in nanometer regions during femtoseconds by excitation of localized modes, resulting in a strong field enhancement. This series of time-resolved photoelectron micrographs demonstrates the control of SPPs in a microstructured silver film on a femtosecond time scale (3 μm vertically, 0.7 μm horizontally, probed with 10-fs visible laser pulses and 0.3-fs precision). From left to right, the phase between two incident pulses is changed while the photoelectron yield is imaged with a spatial resolution of 50 nm. Initially, the localized SPPs oscillate in phase with the optical driving field (left), but they de-phase within tens of femtoseconds and oscillate with their intrinsic resonance frequency (right). Spatial de-coherence can be imaged as well, indicated by circles. From A. Kubo, K. Onda, H. Petek, Z. Sun, Y.-S. Jung, H.-K. Kim, *Femtosecond imaging of surface plasmon dynamics in a nano-structured silver film*, Nano Lett. **5**, 1123 (2005).

REFERENCES

1. *New Science for a Secure and Sustainable Energy Future*, Basic Energy Sciences Advisory Committee, December 2008, <http://www.sc.doe.gov/bes/reports/list.html>.
2. C.D. Stanciu, F. Hansteen, A.V. Kimel, A. Kirilyuk, A. Tsukamoto, A. Itoh, and Th. Rasing, *All-Optical Magnetic Recording with Circularly Polarized Light*, Phys. Rev. Lett. **99**, 047601 (2007).
3. G.J. Williams, M.A. Pfeifer, I.A. Vartanyants, and I.K. Robinson, *Three-Dimensional Imaging of Microstructure in Au Nanocrystals*, Phys. Rev. Lett. **90**, 175501 (2003).
4. H.N. Chapman *et al.*, *Femtosecond diffractive imaging with a soft X-ray free-electron laser*, Nature Physics **2**, 839 (2006).
5. H.N. Chapman, A Barty, S. Marchesini, A. Noy, S.P. Hau-Riege, C. Cui, M.R. Howells, R. Rosen, H. He, J.C.H. Spence, U. Weierstall, T. Beetz, C. Jacobsen, and D. Shapiro, J. Opt. Soc. Am. **A 23**, 1179 (2006); Y. Nishino, Y. Takahashi, N. Imamoto, T. Ishikawa, and K. Maeshima, *Three-Dimensional Visualization of a Human Chromosome Using Coherent X-ray Diffraction*, Phys. Rev. Letters **102**, 018101 (2009).
6. A. Mugarza, J.E. Ortega, F.J. Himpsel, and F.J. García de Abajo, *Measurement of electron wave functions and confining potentials via photoemission*, Phys. Rev. B **67**, 081404 [R] (2003).
7. T. Kondo *et al.*, *Dual character of the electronic structure of $\text{YBa}_2\text{Cu}_4\text{O}_8$: the conduction bands of CuO_2 planes and CuO chains*, Phys. Rev. Lett. **98**, 157002 (2007).
8. T.W. Ebbesen, H.J. Lezec, H.F. Ghaemi, T. Thio and P.A. Wolff, *Extraordinary Optical Transmission through Sub-Wavelength Hole Arrays*, Nature **391**, 667-69 (1998).

9. B. Heitkamp, F. Kronast, L. Heyne, H.A. Dürr, W. Eberhardt, S. Landis, and B. Rodmacq, *Femtosecond spin dynamics of ferromagnetic thin films and nanodots probed by spin polarized photoemission electron microscopy*, J. Phys. D **41**, 164002 (2008).
10. Y. Acremann, J.P. Strachan, V. Chembrolu, S.D. Andrews, T. Tyliczszak, J.A. Katine, M.J. Carey, B.M. Clemens, H.C. Siegmann, and J. Stöhr, *Time-Resolved Imaging of Spin Transfer Switching: Beyond the Macrospin Concept*, Phys. Rev. Lett. **96**, 217202 (2005).

5. CONCLUSION

The Photon Workshop summarized in this report identified the vast unfulfilled need for probing the interaction of light with matter at ever decreasing length and time scales and in ever increasing precision and detail. Secrets hidden just beyond our reach include the elementary steps in catalysis and chemical transformation through bond making and breaking; correlations among electrons and spins that create high-temperature superconductors, multiferroics, and the phase transitions among metals, insulators, and magnets; and biological complexity that enables remarkable levels of functionality well beyond human design capability. The orders-of-magnitude greater photon intensity, shorter pulse width, and greater coherence of fourth-generation light sources will bring these fundamental mysteries of the natural world within our grasp. The benefits of solving these mysteries will accrue not only to science itself but also to new technology for solving societal problems, including sustainable energy, climate change, information technology, medicine, and economic growth.

Interactions of light with matter play a dual role in advancing the frontier of science and technology. On the one hand, they dramatically extend our observational reach. We will be able to see the subtle structural and dynamic features that govern the behavior of matter and flow of energy at nanometer length and femtosecond time scales. This unprecedented access to the ultrasmall and ultrafast world of electrons, molecules, and photons will add immeasurably to our knowledge of how and why things happen. On the other hand, this knowledge and the ability to manipulate the interactions between light and matter on these same length and time scales will allow us to control the phenomena we see. Exploiting our new-found observational knowledge, we can create new structures of increasing complexity that will control the flow of photons, electrons, and spins at nanometer length scales to achieve new functionality. The rise of control science—the application of knowledge at the frontier of science to control phenomena and create new functionality—will be one of the primary scientific developments of the next half-century. Fourth-generation light sources are at the leading edge of this emerging trend.

Control of matter and energy on ultrasmall and ultrafast time scales will have an especially large impact on next-generation sustainable energy technology. The materials and chemistry of sustainable energy are much more complex and must be much more functional than the commodity-based materials of fossil energy. Sustainable energy materials must efficiently convert energy among photons, electrons, and chemical bonds, processes that are intrinsically embedded in the ultrasmall and ultrafast domains that we are just beginning to master. The observation and control of nanoscale structure and ultrafast dynamics enabled by fourth-generation light sources open broad new horizons for advancing sustainable energy.

As this report shows, next-generation light sources bring order-of-magnitude advances in average brilliance, peak brilliance, ultrafast time structure, and coherence. The wealth of promising new science directions enabled by these quantitative advances is so broad that a single photon source cannot cover them. Several of the new directions have conflicting requirements. High peak intensity and ultrashort pulses are needed, for example, to probe the small numbers of molecules in a chemical reaction and capture the fast dynamics of bond breaking and making, whereas high average brilliance at lower peak intensity and high repetition rate are needed for high-resolution spatial imaging to avoid radiation damage and space-charge effects. To realize the full spectrum of science that fourth-generation photon sources enable requires pursuing research and development on separate sources for high peak brilliance and ultrashort pulse length for dynamic studies on the natural time scales of electronic and molecular motion, and high average brilliance at lower peak intensity and higher repetition rate for studies of the three-dimensional spatial structure and energy-level spectroscopy of static or slowly changing nanoscale systems. Each class of sources opens compelling new horizons in observational and control science. Research and development should be undertaken to define and extend source performance limits and enhance the practicality, affordability, and usability of such facilities.

But light sources alone are not enough. The photons produced by light sources must be channeled into state-of-the-art experiments installed at fully equipped end stations. Sophisticated wide-area detectors that operate on sub-femtosecond time scales with high energy resolution must be designed and created. The theory of ultrafast phenomena that have never before been observed must be developed and implemented. Enormous data sets of diffracted signals in reciprocal space and across wide energy ranges must be collected and analyzed in real time so that they can guide the ongoing experiments. These experimental challenges—end stations, detectors, sophisticated experiments, theory, and data handling—must be planned and provided for as an integral part of the photon source. They are the primary factors determining the scientific and technological return on the photon source investment.

Of equal or greater concern is the need for interdisciplinary platforms to solve the grand challenges of sustainable energy, climate change, information technology, biological complexity, and medicine. No longer are these challenges confined to one measurement or one scientific discipline. Fundamental problems in correlated electron materials, where charge, spin, and lattice modes interact strongly, require experiments in electron, neutron, and X-ray scattering that must be coordinated across platforms and user facilities. Understanding the fundamental mechanisms of catalytic chemical change requires structural imaging, energy-level spectroscopy, and time-resolved dynamics. Probing biological complexity requires protein crystallography and dynamic studies of macromolecular structure and conformation. In all of these interdisciplinary challenges, materials synthesis, theory, and modeling must be integrated at a fundamental level. The model of users applying for one-time access to single-user facilities does not promote the coordinated, interdisciplinary approach needed to solve today's grand challenge problems. Next-generation light sources and other user facilities must learn to accommodate the interdisciplinary, cross-platform needs of modern grand challenge science.

The Photon Workshop revealed broad new opportunities for understanding and controlling the fast dynamics of catalysis and chemical reactions; the structure, interaction, and function of biological macromolecules; and the correlation of electrons, spins, and atoms that enable the functionality of complex materials. This report recognizes these promising new directions as the next frontier in observational and control science and endorses pursuing them through the development of fourth-generation photon sources.

APPENDIX 1: PHOTON SOURCES

A-1.1 STORAGE RINGS

Storage ring sources have formed the basis for the success of accelerator-based light sources over the last decades. They have reached such a level of technical sophistication that they are operating extremely reliably and reproducibly, close to the theoretically calculated performance limits. This is demonstrated by the use of storage rings as (legal) calibration standards for electromagnetic radiation over the wavelength range of terahertz (THz) to X-rays. Third-generation synchrotron radiation sources based on high-brilliance storage rings equipped with a multitude of specialized insertion devices for ultimate photon source performance are serving an ever-increasing community of scientists and science disciplines. Worldwide, more than 50 facilities are involved in research, metrology, and fabrication, with tens of thousands of researchers performing their individual experiments at a highly competitive level. Twelve of these facilities belong to the most modern, third-generation sources. Several more facilities are under construction worldwide, but the demand for beam time still outpaces the development of new capabilities.

The wavelength range of storage rings covers the full spectrum, from terahertz radiation to hard X-rays, with selectable and precisely controlled polarized light produced in undulators and wigglers installed in straight sections of the storage rings. The pulse length is typically several tens of picoseconds (ps), even though special electron-optic schemes or femtosecond (fs) slicing with an external laser have been incorporated at several facilities, allowing for studies with substantially reduced pulse lengths (down to less than 100 fs), even though at a considerably reduced intensity. State-of-the-art facilities have 50 or more experiment stations, where research can be performed with individually and independently selectable photon characteristics matched to the requirements of the experiments.

As with all accelerator-based sources, performance is based upon a combination of properties of the electron beam, as well as the magnetic devices used to generate the radiation. Emittance (ϵ) is the intrinsic parameter describing the source size and divergence of the electron beam and, thus, the intrinsic quality factor of the electron beam. The emittance of storage rings is measured in terms of E^2/R , where E is the electron energy and R the bending radius. Superimposed on the electron beam emittance are the characteristics of the insertion device used to produce the photon beam. The combination of these parameters determines the brilliance of the photon beam. Modern storage ring facilities operate in a parameter range where the electron beam emittance contributes significantly to the brilliance of the photon beam.

The brilliance of the photon beam, like the emittance of the electron beam, is an intrinsic quality factor. The brilliance is not altered by focusing (Liouville's theorem), and it essentially limits the number of photons that can be focused into a certain spot size. Obviously, imperfect optical components used to manipulate the photon beam diminish the brilliance. Thus, any kind of microscopy/microanalytics experiment immediately has benefits proportional to the improvement in the brilliance, whereas many conventional experimental techniques measure performance proportional to the total photon flux arriving at the experiment. The coherence of the photon beam scales with the brilliance.

Average brilliance parameters of storage ring sources are shown in Figure 28. Here, European sources are taken as examples. U.S. sources, including those under construction (such as NSLS-II) are projected to exhibit comparable performance.

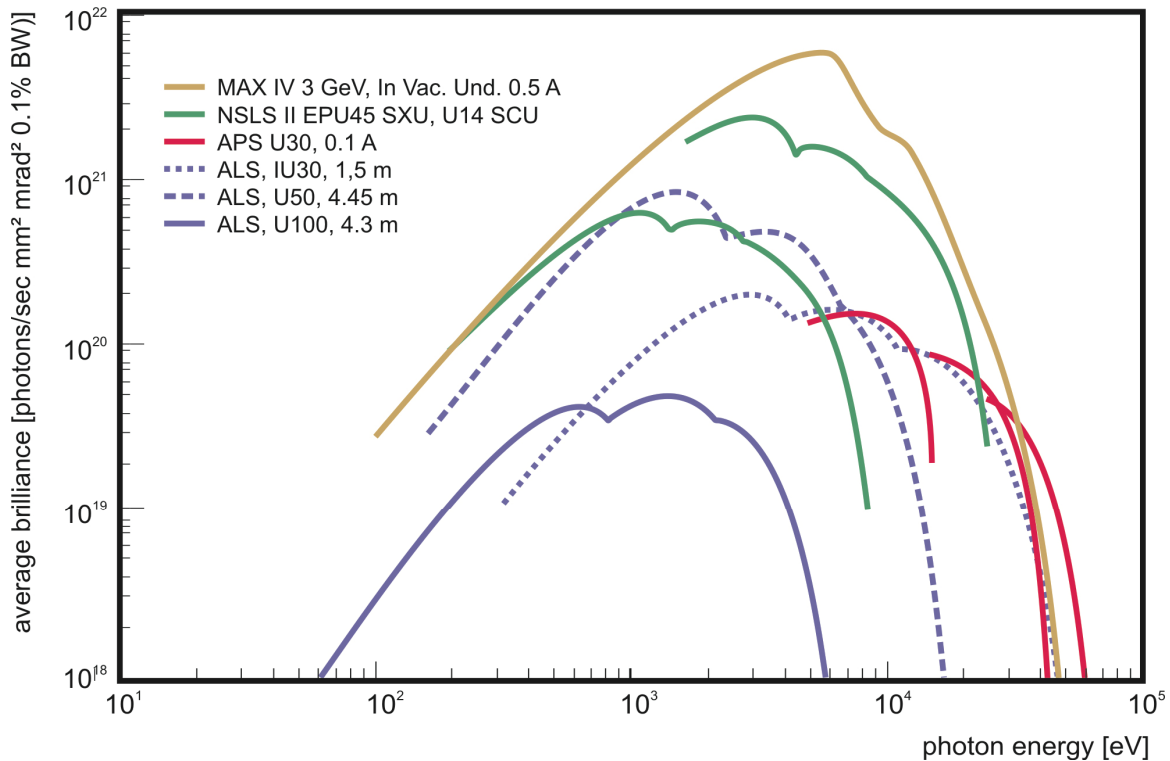

Figure 28 Average brilliance of photon beams generated by various insertion devices at existing (ALS, APS) storage ring sources, including calculations of the NSLS-II and the planned MAX IV facility. All curves are for 500-mA beam current except the APS curves, which are plotted for 100 mA.

Other photon beam properties are of relevance to the experiments as well. One such property is the polarization, which can be freely selected. Circular and linear polarization, and even the plane of the linear polarization, can be arbitrarily rotated from horizontal to vertical using state-of-the-art undulators. Furthermore, at storage rings, the complete photon energy range is accessible, from terahertz to hard X-rays, without any change in the electron beam parameters. The details of the performance and the individual tuning range depend on the specific insertion device and the corresponding beamline. Typically, the photon energy (and resolution) can be tuned on a time scale of seconds. The energy resolution can be as high as $E/\Delta E = 10^6$, depending on the monochromator or optics used. In special cases, even higher resolution values are achievable.

Time resolution is typically limited to 20-50 ps, depending on the length of the electron bunch circulating in the storage ring. Special electron optics allow one to reduce the bunch length to produce photon pulses in the sub-picosecond range, even though overall bunch charge (beam current) is reduced. Slicing the electron bunch with an external laser was pioneered at the ALS and has also been implemented at BESSY-II and the SLS, giving pulses of less than 100 fs in the soft to hard X-ray range, again at a reduced overall intensity. Unlike those from laser-based sources (high harmonic generation), the pulses can be completely controlled with respect to polarization parameters; pulses of similar quality cannot be produced by any laboratory (tabletop) laser scheme.

The coherence length of the photon beam is 10–30 mm, both longitudinally and laterally. The coherence scales directly with the brilliance of the beam and decreases with increasing photon energy. For example, coherence enables holographic imaging techniques to be exploited through careful consideration of photon beam properties.

The question arises about the performance of the “ultimate” storage ring facility. Theoretically, this can be approximated by setting the electron beam emittance to zero in calculated performance curves. Even though this seems an academic exercise, it nevertheless defines the intrinsic limitations of all storage ring light sources. Figure 29 shows the theoretically possible improvement of the photon beam brilliance for some examples (all other parameters are kept fixed). For example, from these graphs, one can deduce that ~ 1 keV photon energy can be expected for a 3-GeV electron beam, an improvement of one order of magnitude, while this improvement is noticeably larger for a 7-GeV electron beam. Also, at higher photon energies of ~ 10 keV, the possible improvement using an “ultimate” storage ring, compared to a state-of-the-art present-day facility, is more than two orders of magnitude higher. This is in line with the above-referenced scaling of electron beam emittance proportional to E^2/R . A “real” storage ring at a larger energy will have an intrinsically larger emittance and produce a less brilliant photon beam.

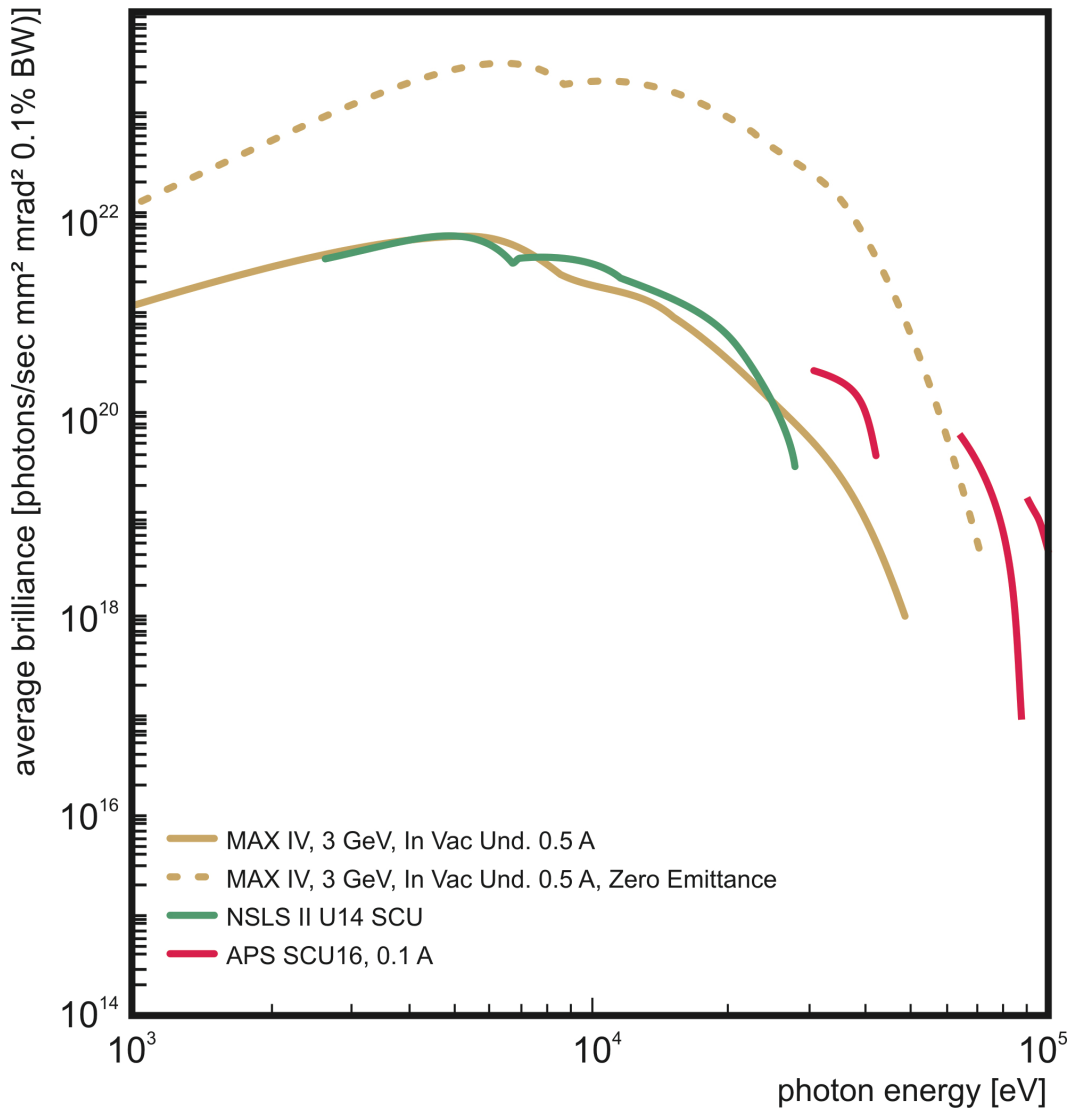

Figure 29 Average brilliance of several insertion devices (IDs) at state-of-the-art storage ring facilities and the influence of the electron beam emittance. The finite emittance reduces the average brilliance from 1 to 3 orders of magnitude. From this comparison, we can estimate the performance of these same IDs in an ultimate storage ring.

A-1.2 LINAC-BASED PHOTON SOURCES: ADVANCING BEYOND THIRD-GENERATION SOURCES

The synchrotron user community continues to grow steadily, attracting new science fields, such as archeology and cultural heritage. Even more important, demands regarding the quality of photon source parameters are also increasing noticeably. Experiments are becoming more demanding and sophisticated. The analysis of nanoscale systems with respect to structure and electronic properties has generated a large increase in interest from the user community, not only in materials sciences, but also in biology, as well as in life and environmental sciences. Individual nano-sized structures and materials tailored to deliver novel, dedicated performance require analytical probes with ever-increasing spatial resolution. The implications for light source design are straightforward. Lower-emittance electron beams result in higher-brilliance photon beams, as well as a higher coherence fraction, and thus directly improve focusing on the nanometer scale for high-resolution microscopy and spectroscopy applications.

In addition, as experiences at the FLASH facility and at LCLS demonstrate, there is a substantial interest in studying dynamic processes requiring high-brilliance, femtosecond X-ray pulses, which are generally outside the range accessible by storage rings. Proposals for experiments range from charge-carrier dynamics in materials to chemical reaction kinetics. Another interesting question relates to the development of an understanding of the processes determining the ultimate time scale of magnetic data recording. Initial, pioneering studies of this kind have been performed at femto-slicing facilities in storage rings, but only with great effort because of the low flux. Furthermore, not only are short pulse lengths important, but so also is the ability to control the exact shape of the pulses and to synchronize these to external (laser) sources.

Realizing these sophisticated and demanding investigations is clearly beyond the capabilities of existing storage-ring-based sources. Accordingly, one has to use a different approach. Next-generation light sources must circumvent the equilibrium beam properties of a storage ring source (i.e., the beam must be discarded before it has a chance to sample and occupy all of the phase space offered by the magnetic lattice of the storage ring). A single-pass linear accelerator represents the most extreme example of such a device. In contrast to the case of storage rings, the electron beam emittance decreases in a linear accelerator as the energy of the electrons increases. Provided one takes care not to disrupt the beam, it maintains the properties generated in the LINAC, with the emittance being *damped* adiabatically by a factor inversely proportional to the beam energy. Ultra-low emittances are thus attainable by acceleration, provided the electron source produces a beam of suitable quality.

Other parameters, especially the bunch length, can be optimized by bunch compression techniques along the LINAC, providing a high degree of flexibility to address user requirements. Sub-picosecond pulses can be generated, up to 1000 times shorter than in a storage ring. These operational modes of a linear-accelerator-driven light source have already resulted in pulse lengths of ~ 10 fs at the FLASH facility in Hamburg.

Two different types of linear-accelerator-based light sources are discussed below.

Free electron laser and energy recovery LINAC sources. Even though both FEL and ERL sources use ultra-bright LINAC-generated electron beams to produce photons, their source characteristics are sufficiently different that they serve different purposes and largely different science areas. The typical layout of an FEL is shown in Figure 30a, and the generic design of an ERL is shown in Figure 30b.

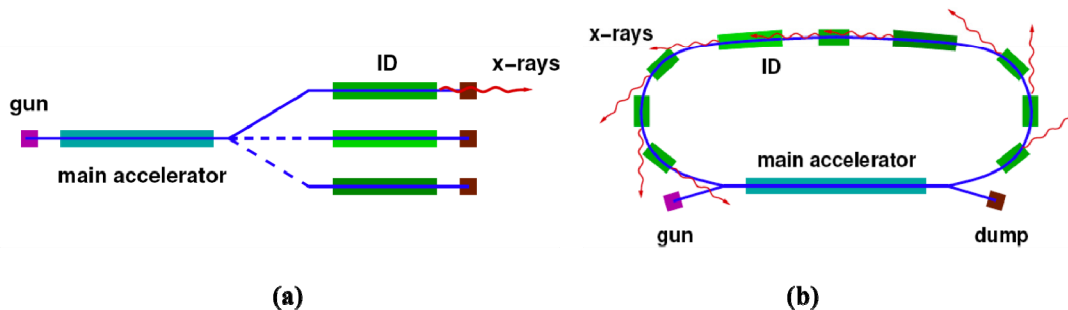

Figure 30 Schematic layout of an FEL facility (a) and an ERL facility (b).

In the FEL, the electron bunches are accelerated in the LINAC and then distributed alternately into several long undulators to produce FEL radiation at the individual wavelength given by the beam energy and the undulator (ID) parameters. After the FEL process, the emittance of the electron bunch has deteriorated such that it cannot be used for the FEL process again (or only at substantially longer wavelengths), and the beam is dumped. Accordingly, the FEL serves only a few experiments at any one time (typically between 1 and 10) with photon pulses of extremely high peak brilliance. Whenever experiments are considered that require a high average brilliance, one has to take into consideration the number of experiments that are served in parallel by the same LINAC.

The ERL, on the other hand, is a true multi-user machine. The ultra-bright electron bunches are accelerated and then passed through an arc of insertion devices, very similar in layout to a storage ring. At the end of the turn, the bunch is passed into the LINAC again, to decelerate the electrons and to regain beam energy. This helps to substantially reduce the operational costs of the facility. The important characteristic of the ERL, however, is that the electron bunches maintain the properties of the LINAC source and never reach the equilibrium properties of a bunch circulating in a storage ring. It typically requires thousands of turns in a storage ring for a freshly injected bunch to reach an equilibrium state. Thus, the ERL operates similar to the storage ring, where all users share the same bunches, but the ERL excels in average brilliance because of the lower emittance of the electron beam.

For the production of photons in the IR range, both FEL facilities and ERL facilities exist and have generated a well-documented scientific impact. The challenge arises from the demand for production of shorter-wavelength photons. The required performance of these accelerator-driven sources is based upon the emittance of the electron beam, which has to scale relative to the wavelength of the light to be generated. Accordingly, an FEL or ERL operating in the X-ray range needs to have an electron beam emittance that is at least a factor of 10^3 smaller than that of an ERL or FEL operating for the production of IR photons.

A-1.3 FREE ELECTRON LASERS

Free electron lasers offer outstanding performance, as far as the peak brilliance of the photon pulse is concerned. They will enable the study of nonlinear phenomena and processes or the investigation of very dilute samples, such as individual size-selected nanoparticles, biological molecules, or highly excited short-lived species in plasma processes. The combination of an FEL with a second, external laser source, used to either excite or create a certain species, offers unique prospects for science.

The basis for the special performance of the FEL is an internal modulation of the electron density in the bunches. Once this modulation has been achieved at a certain wavelength (λ), all the electrons in the bunch will emit coherently at this wavelength; thus, the electron beam has been transformed into a laser

medium. This electron density modulation can be achieved by seeding with an external laser or by spontaneous self-modulation. Such a self-amplified spontaneous emission (SASE) process is illustrated in Figure 31. As the electron bunch travels through a suitably long undulator, it spontaneously emits radiation, which is greatly enhanced at the wavelength given by the harmonics of the undulator radiation. The interaction of this photon field with the electron bunch results in an energy transfer and, subsequently, a spatial modulation of the electron density in the bunch at the wavelength of the emitted radiation. Once this spatial modulation is achieved, all electrons emit coherently. This results in a dramatic gain in the radiation emitted at the principal wavelength of the undulator and at higher harmonics. Eventually the gain saturates, because the spatial modulation of the electron bunch is destroyed by emission of the photons.

This coherent emission process is proportional in scale to n^2 , where n is the number of electrons in the bunch contributing to the process. At a 1-nC bunch charge, which is the canonical number for any FEL project, this corresponds to approximately a factor of 10^9 compared to the superposition of the incoherent emission of the same electrons. This dramatic improvement results in a peak brilliance that is unrivaled by any other source in the X-ray range, as shown in Figure 32. Accordingly, the FEL is uniquely suited for experiments requiring a high peak brilliance. The coherence of the photon beam is proportional to the peak brilliance. The degeneracy of the coherent photon pulse will be up to 10^7 , meaning that there are 10^7 photons per coherence volume. Storage rings have a degeneracy parameter of 1; at an ERL, this value might go up to 10^3 . This will enable new physics to be investigated. Moreover, any investigation involving nonlinear processes clearly benefits directly from this peak brilliance, proportional to the n th power of the peak brilliance for an n -photon process.

The polarization of FEL radiation is determined by the insertion device. Thus, it is absolutely no problem to generate circularly polarized (soft) X-rays, a feat nearly impossible to achieve using conventional laboratory laser sources.

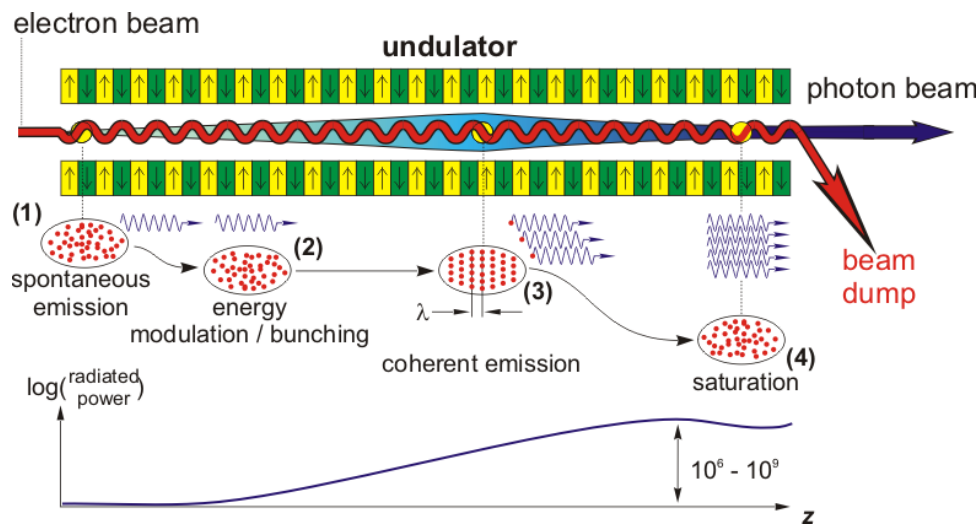

Figure 31 Schematic of the SASE process. The electron bunch is modulated in space by interaction with the photon field it generates. The graph at bottom shows the gain curve for the SASE FEL emission.

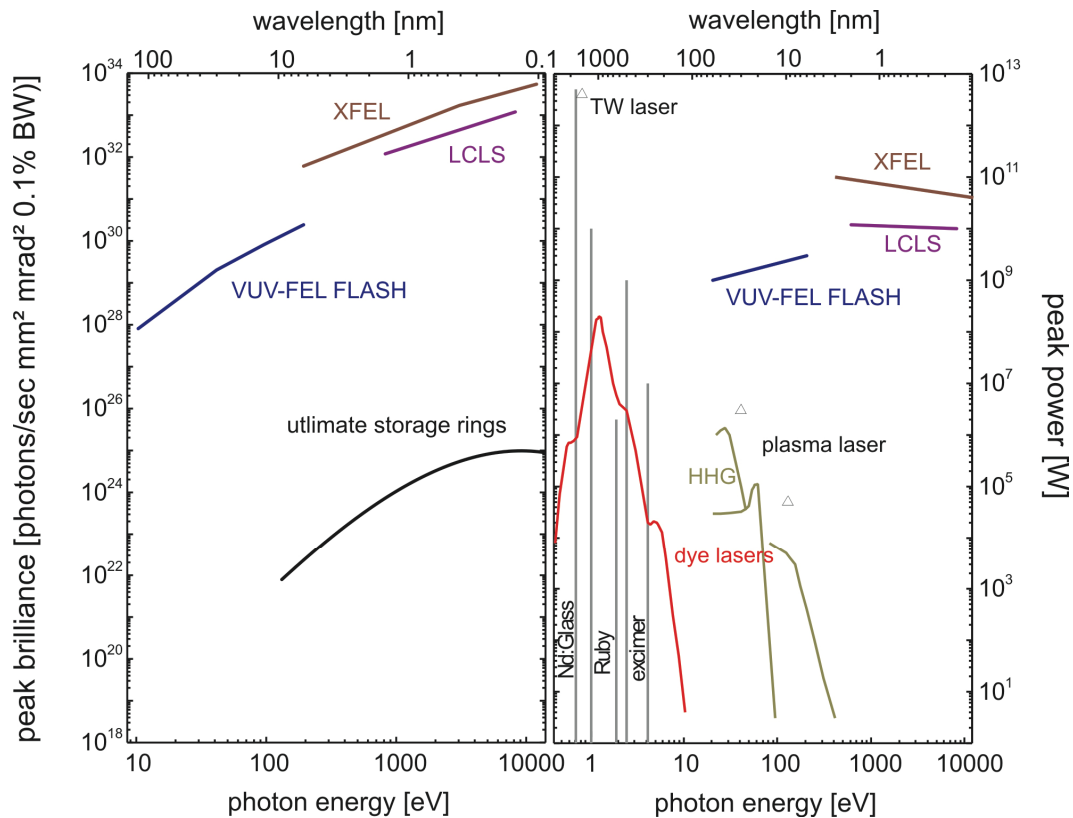

Figure 32 Peak brilliance and peak power of several existing or planned FEL facilities compared with those of storage ring undulators and laboratory laser sources.

The layout of a typical FEL facility is shown in Figure 33, which is taken from the technical design report of the European X-FEL facility. The beam coming from the superconducting LINAC is sent into either one of the two FEL branches, labeled SASE 1 and SASE 2, respectively. After the bunch in SASE 2 has reached saturation, the emittance of the electron beam has grown substantially, such that the same bunch can only be used for normal radiation in the spent beam undulators U1 and U2. Similarly, after SASE 1, a SASE FEL process can only be reached at a substantially longer wavelength (SASE 3), which is proportionally less stringent as far as the emittance is concerned.

Due to the large gain experienced in the coherent FEL process, and despite the low pulse repetition rate, the average brilliance of an FEL facility is quite high, in the range of ERL sources, generally surpassing average brilliance values of today's storage rings. Most tabulated average brilliance values of FEL facilities published so far, however, do not take into account that the accelerator beam will be distributed to 10 stations or more in an advanced FEL facility. Furthermore, the average brilliance has to be viewed with caution to the extent that, for experiments requiring high average brilliance, nonlinear effects could be detrimental; also, special care has to be taken that the high peak brilliance does not destroy the sample. This will be discussed in more detail in the section comparing the various facilities (below).

The second outstanding feature of the FEL is that the pulse lengths are typically 100 fs or less. This enables time-resolved investigations of a quality far beyond anything possible at storage ring sources. Time-resolved diffraction or imaging enables the investigation of structural changes or phase transitions in real time. Time-resolved spectroscopy allows the monitoring of chemical reactions in real time: the

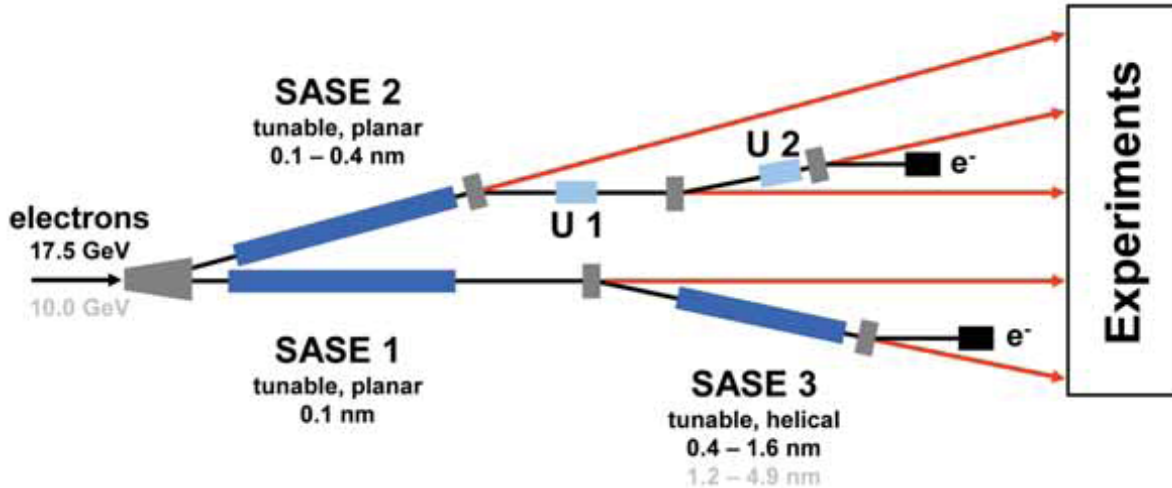

Figure 33 Layout of the photon sources at the initial stage of the European X-FEL facility.

investigation of charge carrier generation, propagation, and collection processes in solar cells, for example. It also allows the identifying of traps and recombination centers that degrade the device performance.

Very often, pump-probe investigations will require the synchronization of an external laser to the FEL pulse. As with synchronizing two independent tabletop lasers operating in the visible or IR range, the jitter and drift of synchronization will cause the temporal resolution achieved in these studies to deteriorate. There is a substantial effort under way at various FEL facilities to develop schemes to reduce the jitter between these sources and, thus, to improve the synchronization. Moreover, advanced seeding concepts will substantially reduce this problem, as described below.

Pulse repetition rates of FEL pulses depend largely on the LINAC design used. Conventional (warm) LINACs operate at a 10–120-Hz cycle. In each cycle, up to several thousand electron bunches can be accelerated, spaced in time according to the frequency of the RF field. Thus, the pulse pattern of an FEL has two characteristic frequencies. The macropulse frequency is given by the main LINAC frequency of 10–120 Hz, while the individual pulses within each macropulse are spaced by 2 ns for a 500-MHz RF frequency. Superconducting LINACs are being proposed for advanced FEL designs operating in a so-called DC mode, where the radio-frequency (RF) field of the LINAC is permanently turned on. This would enable a more evenly spaced pulse pattern; for example, tens of micropulses spaced at a repetition rate of several kilohertz. The limitations with respect to the overall number of pulses of an FEL currently are between 10^4 and 10^5 pulses/s. This limitation arises from the gun design of the accelerator complex.

The energy resolution $E/\Delta E$ of the pulses does not typically exceed 10^3 . This is the inherent bandwidth of the emission from a long undulator. At best, the pulse is transform-limited, and thus the pulse length and energy spread are coupled via the uncertainty limit. Monochromatization is possible at the expense of time resolution. Any grating will lengthen the pulses proportionally to the number of grating lines used. Special compensating optic designs for monochromatization using two gratings have been suggested, but this would reduce the intensity by (typically) one order of magnitude for each grating.

Tuning the photon energy of the FEL is achieved by changing the gap of the undulators, the electron beam energy, or both. Undulator gap tuning typically allows changes by a factor of 4 in photon energy or correspondingly in wavelength. This is comparable to the tuning range of a storage ring undulator in the first harmonic. Since the FEL is a high-performance machine requiring utmost precision in terms of the

emittance and compression of the electron bunch, tuning the FEL to a substantially changed photon energy or wavelength is a lengthy and elaborate process. At presently operating facilities (FLASH), this typically takes hours to accomplish. This corresponds to the situation experienced with tunable femtosecond lasers 15 years ago. Laser technology developments have progressed so that now this can be achieved at the flick of a switch (if no change of optics is required). With more experience and better diagnostics, it should be possible to tune the FEL wavelength to significantly shorter time scales than at present. Nevertheless, changing the photon energy at an FEL will always be much more delicate than at a storage ring source. Experiments requiring a rapid scan of photon energies over a larger range, such as EXAFS investigations, are unsuitable for FELs.

Second-generation FEL Facilities; Seeding Concepts

As the SASE process starts with the spontaneously emitted radiation in the first part of the undulator, the pulse characteristics are stochastic and intrinsically irreproducible. The wavelength and temporal structure will differ from pulse to pulse within certain boundaries, as different modes are contributing to the overall pulse envelope. This very much resembles the case of a short-pulse laser without mode locking. Furthermore, the synchronization of external lasers for pump-probe studies is difficult.

Accordingly, ideas were generated to circumvent the shortcomings of the SASE process. It was demonstrated quite early at Brookhaven National Laboratory (BNL) that an external laser can be used to initiate the spatial modulation of the electron bunch, which prepares the “medium” (the electron bunch) for the coherent laser process. Thus, the pulse properties of the external laser are imprinted onto the laser medium, and the electron bunch then radiates with these pulse properties at the same frequency (wavelength) or at a higher harmonic of it. Essentially, the FEL is used in this mode as a powerful amplifier of externally produced photons. This so-called seeding process results in a much higher stability and reproducibility of the pulse shape of the FEL radiation and also benefits from the exact synchronization to the external seed laser pulse. A split-off portion of this seed laser pulse can be used for pump-probe experiments, thus eliminating the dominant contributions to jitter between the two sources.

The quality improvements by seeding as compared to SASE radiation are shown in Figure 34.

Figure 34 shows numerical simulations of a seeded FEL (left) and the corresponding SASE FEL (right). Clearly, the quality enhancement is visible, even though the peak power of the seeded FEL pulse is reduced by about one order of magnitude. The simple reason for this is that in the seeded FEL, only the part of the electron bunch that is modulated by the seed laser contributes significantly to the FEL emission. The seed laser pulse can be generated by HHG, for example, as will be described later. Alternatively, a cascading scheme can be used; the seeding process is cascaded through several stages, always producing radiation at a higher harmonic (third or fifth) of the seed laser. This is referred to as HGHG (high gain harmonic generation). The present consensus is that these seeding schemes will enable photon energies to reach as high as 1 keV or wavelengths as low as 1.2 nm. For harder X-rays, it is difficult to get a seed laser with sufficient power. In addition, the HGHG cascading is limited in the number of conversion stages, since with each stage the accuracy in reproducing the pulse shape of the seed pulse is not 100% perfect. Because of the obvious advantages of seeding, most of the future low-energy X-ray FEL facilities, planned or under construction, will implement seeding in one form or another.

The importance of seeding and online diagnostic tools for the verification of the pulse shape of the FEL is highlighted by the first actual measurements at the FLASH facility via an autocorrelation experiment. Figure 35 shows the visibility of the two-beam interference pattern, using an autocorrelator to split, delay,

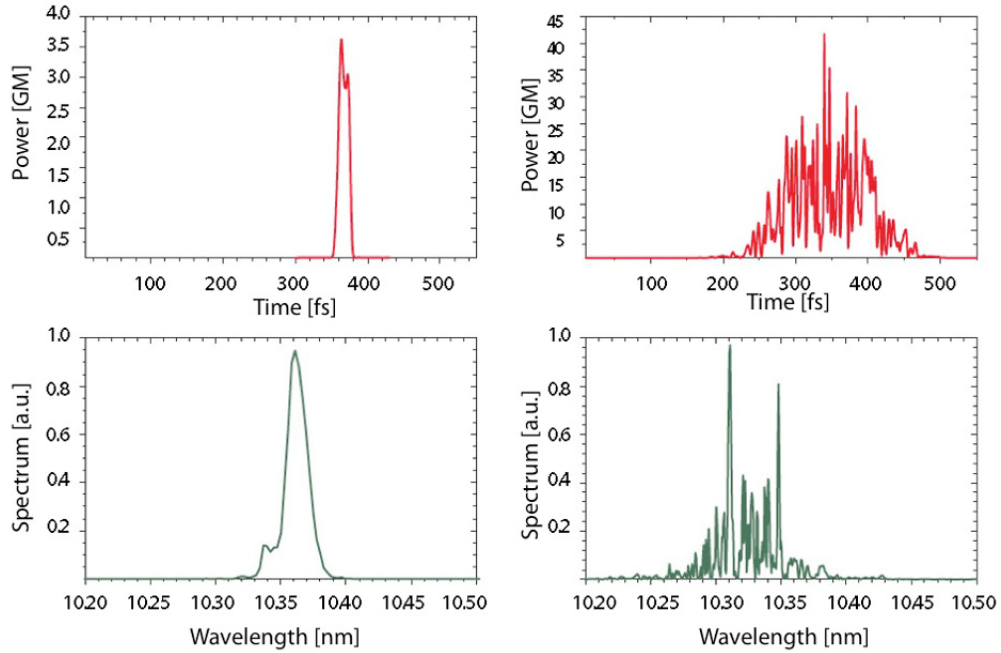

Figure 34 Model calculations of FEL pulses at 10.3-nm wavelength generated in a seeded (HG) FEL (left panels) in comparison with SASE-FEL pulses (right panels).

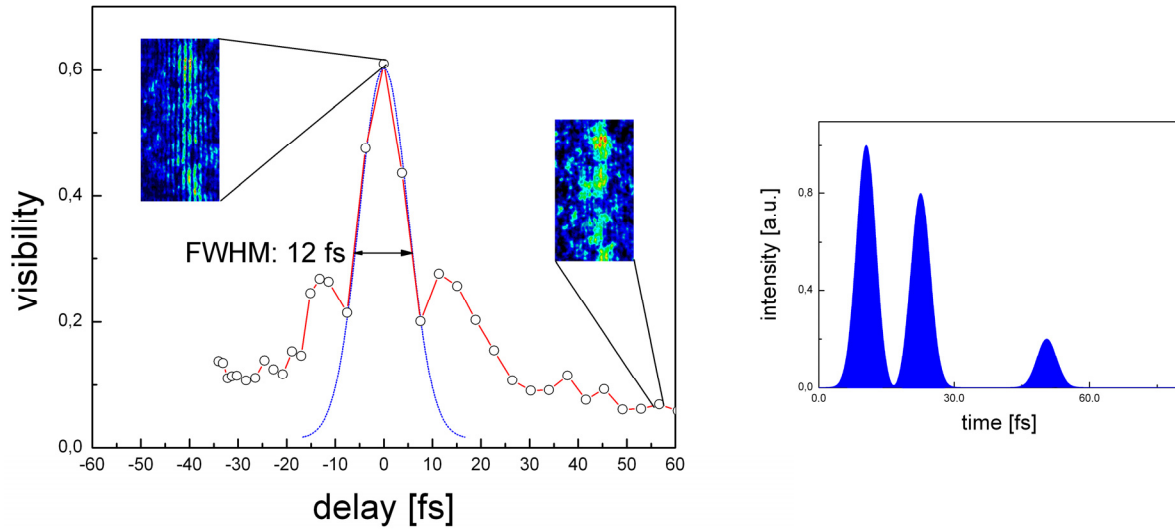

Figure 35 Linear autocorrelation of the FLASH FEL pulse at 23.9 nm, utilizing two-beam interference. Plot of the experimental visibility of the spatial fringes and a Gaussian fit to the main peak (left) and pulse shape deduced from these measurements (right). This experiment provides proof of the principle that pulse lengths in the 10-fs range can be achieved by FELs.

and finally recombine the FLASH pulse. The visibility of interference at a delay of 50 fs directly proves that the FLASH FEL pulse has to have significant intensity over this time span. The pulse shape deduced from these measurements actually corresponds to a triple pulse structure, as shown in the left of the figure.

There is a simple way to discuss the implications for the science enabled by the control of the pulse shape or hampered by the lack of this control. If the experiment uses only one photon per event from the FEL, it is not very much influenced by the exact temporal pulse shape. This is the case in one-photon events in dilute samples. For example, the determination of the structure of an individual nanoparticle by scattering does not depend on the pulse shape of the FEL pulse, unless the nanoparticle is destroyed within the timeframe of the FEL pulse. Spectroscopy on highly diluted species is another possible example, irrespective of the knowledge of the exact pulse shape.

On the other hand, if nonlinear (multiphoton) processes are investigated, then the exact pulse shape is of utmost importance. For example, using lasers in the visible or near ultraviolet (UV), the pathway of a two-photon photochemical reaction can be deliberately changed by changing the temporal shape of the photon pulse. In addition, for any pump-probe study, the temporal shape and synchronization of the photon pulse is of extreme importance.

In summary, FELs are fantastic new photon sources in the soft X-ray range, enabling experiments previously thought impossible. These novel capabilities specifically extend to studies of nonlinear processes and phenomena and to time-resolved studies on the femtosecond time scale. Compared to storage rings, a FEL facility has a substantially reduced number of experimental stations, all of which have to share the beam from the same accelerator. FELs will probably never replace existing storage ring facilities. Rather, they should be viewed as complementary facilities that substantially broaden the horizon for sciences using X-ray photons.

A-1.4 ENERGY-RECOVERY LINACS

While storage rings can accommodate a large number of different experiments over a wide photon energy range, offer a high average flux, and are quite efficient to operate, they also have certain limitations. Since the electron beam is in an equilibrium state, the emittance is on the scale of E^2/R , requiring a very large R to reach small emittances. Furthermore, the energy spread of the electrons and the bunch length are also degraded by the equilibration. The energy spread is typically $>10^{-3}$; the bunch length, between 20 and 50 ps. Sub-picosecond bunches can only be produced with a substantial reduction in beam current, directly reducing the average brilliance.

Energy-recovery LINACs are accelerator-based photon sources that combine the advantages of storage rings with those of a linear-accelerator-driven photon source. ERLs maintain the excellent beam properties of the linear accelerator, where the emittance is on the scale of $1/E$. Essentially, the pulse length of the LINAC is maintained, and the energy spread is on the order of 10^{-4} . The energy spread is important for the generation of higher undulator harmonics. The smaller the energy spread, the more intense are the higher undulator harmonics. Longer undulators also require a low emittance and low energy spread to reach their full potential. Figure 36 shows calculated average brilliance curves for a low-energy (3-GeV) and a high-energy (5-GeV) ERL.

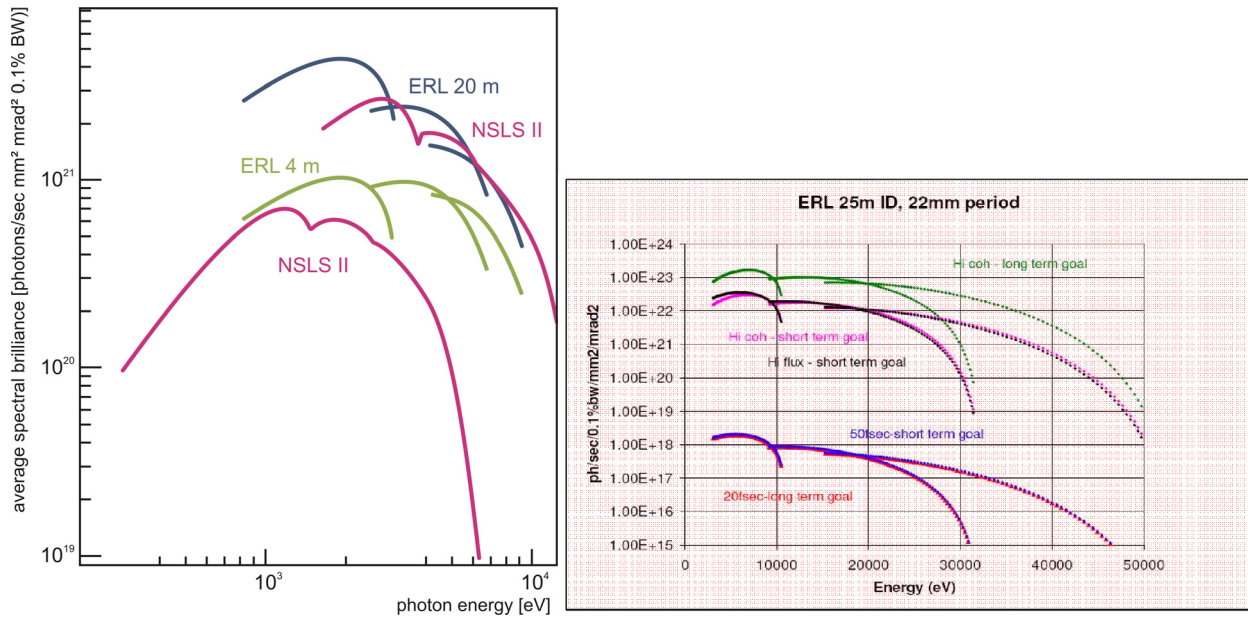

Figure 36 Calculated average brilliance for a 3-GeV ERL (left) and a 5-GeV ERL (right)

The average brilliance of these machines is expected to reach more than 10^{21} at 1-keV and more than 10^{23} at 10-keV photon energy. This is substantially better than any existing or planned storage ring facility (see Figure 28), including the ones under construction now. The brilliance almost reaches the limit of a “zero emittance” accelerator source, as shown in Figure 29. The improvement of the ERL compared with storage rings is more significant at higher photon energies and also at higher electron beam energies, as expected. At low photon energies, corresponding to longer wavelengths, the photon source size is limited by diffraction. This is the case whenever the condition $\varepsilon < \lambda/4\pi$ is met. Under these circumstances, reduction in the emittance of the electron beam alone does not improve the brilliance of the source.

These are not all the effects, however. In a long (25-m) undulator, for example, partial lasing of the electron beam is to be expected for ultra-bright electron beams. This is the same effect as in the FEL described above, but saturation is not reached. Nevertheless, the brilliance can increase by several orders of magnitude. The prediction of the brilliance of ERLs in the extreme ultraviolet (EUV) range accordingly requires detailed dynamic modeling of the electron beam, and this is beyond the scope of this brief review. Seeding the photon beam of such a long undulator with an external laser should also be considered an option, because it offers better control over the photon pulse shape and the synchronization to an external laser for pump-probe experiments.

It should be mentioned that along the beam path around the arc of the ERL, the beam quality will deteriorate, depending on the extraction of photons and the insertion devices installed. The electron bunch properties are not quite the same at the end of the arc as immediately after the LINAC. Care has to be taken that this does not prevent the energy-recovery process.

Another advantage of the ERL versus the storage ring is the round cross section of the beam and the photon source. This is a specific advantage for any imaging application. Furthermore, there is no need to have a large horizontal aperture, which is required for injection into the storage ring. Accordingly, different types of undulators (for example, the APPLE III type) may be constructed and implemented into an ERL. (The Apple III undulator type has a substantially higher field strength on the axis.)

These are not the only advantages of the ERL design as compared to storage rings. In general, the ERL also offers greater flexibility as far as the bunch pattern, repetition rate, and (especially) short-pulse characteristics are concerned. According to present designs, ERLs will operate at an RF frequency of 1.3 GHz. This also is the maximum pulse repetition rate. The ERL offers the possibility of using bunch compression techniques to substantially shorten electron bunches to produce photon pulses as short as 10 fs (at a reduced charge). The ERL offers great flexibility as far as the electron optics and bunch shaping are concerned. This is inherent in ERL design, because the electron beam parameters of the electron gun and the LINAC are essentially the ones determining the photon source. In a storage ring, the photon source is given by the equilibrium reached after thousands of turns. Thus, the electron beam in the storage ring has lost any memory of its source properties.

As far as polarization, wavelength tuning, and resolution of the photon source are concerned, the ERL has properties quite similar to those of a storage ring source. ERLs can satisfy the needs of a large user community *and* enable fascinating new science discoveries not possible with existing machines. The ERL is especially suited for experiments requiring high average brilliance of the photon beam, such as microscopy, microspectroscopy, or high-resolution electron spectroscopy. Compared to an FEL, which is able to reach similar values in average brilliance, the photons of the ERL are spread over at least 10^4 times the number of pulses. Therefore, the danger of nonlinear effects in the sample or in the detector is greatly reduced. Over large wavelength ranges, the ERL achieves performance values close to the theoretical values of the ultimate, zero-emittance accelerator-based sources.

A-1.5 ULTIMATE STORAGE RINGS, ERLs, FELs: WHAT ARE THE DIFFERENCES?

As stated above, the performance of storage rings is ultimately limited by the equilibrium properties of the stored beam. The electron beam emittance is on the scale of $1/R$ of the bending radius, but this also imposes a physical size limit. Thus, the quest for ultimate performance leaves the LINAC-driven light sources as sources for the fourth generation, to replace and complement today's storage rings. FELs offer unique science opportunities whenever a high peak brilliance is crucial. This is the case, for example, for the study of nonlinear phenomena and ultra-low-density dilute samples, as well as whenever short-(femtosecond-) pulse characteristics are required. Seeding the FEL beam with an external laser-driven source will substantially enhance the quality and reproducibility of the shape of FEL pulses. This also will improve synchronization for pump-probe studies. Whenever a high average brilliance is the key requirement for investigation, then the ERL is the source of choice. Such experiments include many imaging applications, as well as high-resolution electron spectroscopy, where space-charge effects are a concern. For time-resolved investigations, the ERL offers 10-fs pulses (whenever the peak brilliance is not required). Accelerator-based light sources are compared to storage rings in Figure 37.

The ERL offers high flexibility. It can be operated with multiple guns and in a set of different modes, emphasizing either high average brilliance, high coherence, or short pulses. Furthermore, pulses can be extracted from the ERL and run into long FEL undulators. Even if the peak current of the accelerator does not match the extreme conditions of the X-ray FEL, lasing is achieved by setting up an optical cavity for the X-ray pulses with a back of reflecting crystals. Such a scheme has been proposed and is outlined in Figure 38.

The scheme is included here to demonstrate the ultimate flexibility of using a superconducting linear accelerator as the basis for a future accelerator-driven X-ray light source facility. There are many clever ideas and concepts around, and more will be generated. One just has to realize that the source of the photons in all these schemes is an electron bunch, shortened to sub-picosecond bunch length, with a very low emittance and high peak current. Once the charge of this bunch is modulated at a certain wavelength, it turns into a laser medium at that wavelength, and all the electrons start to emit coherently.

Third generation x-ray sources

Storage ring

$\epsilon \sim E^2/R$
 $\tau_{lifetime} \gg \tau_{relaxation}$
 bunch charge 1nC

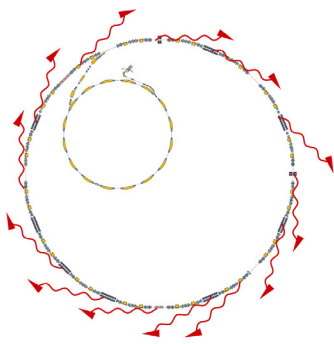

- Many experiments
- Ready tunability
- High flux
- ps pulses

Fourth generation x-ray sources

LINAC source (=> FEL)

bunch charge ≤ 1 nC

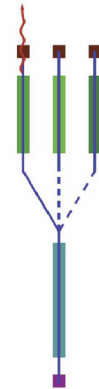

- Extremely high peak brilliance
- Full spatial coherence
- Ultrashort (fs) pulses
- Temporal coherence with seeding in future
- pulse rep. Rate 10^2 to 10^6 Hz
- Few experiments

Energy-Recovery LINAC

$\epsilon \sim 1/E$
 $\tau_{lifetime} \ll \tau_{relaxation}$

bunch charge < 100 pC

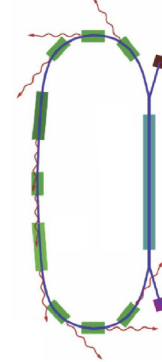

- High average brilliance
- Full spatial coherence
- Many experiments
- Ready tunability
- High flux
- Flexible pulse characteristics
- Fs to ps pulse lengths
- 10^9 pulses/s

Figure 37 Schematic comparison of storage-ring-based and accelerator-based X-ray light sources.

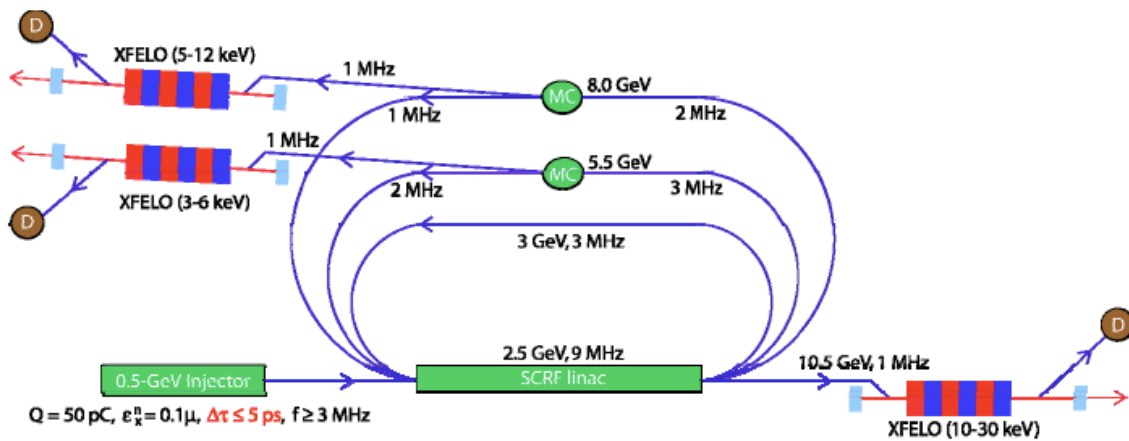

Figure 38 Scheme showing the combination of a superconducting linear accelerator with several return arcs and various X-FEL oscillators (from K.J. Kim).

This points to the ideal tool kit for assembling an X-ray source in the future:

- A superconducting linear accelerator;
- Various electron guns for injection, with different repetition rates, bunch charges, and bunch compression schemes;
- One or more return arcs equipped with a series of sophisticated undulators for multiple experiments; and
- Several fast kickers to extract single bunches into long FEL undulators.

This is a tool kit, and, naturally, the tools chosen for any particular realization will not encompass all these elements but will have to be chosen to match the science target to be addressed.

While an ERL for the IR range has been successfully operating at Jefferson Lab and at the Budker Institute in Novosibirsk, Russia, for quite some time, an X-ray facility based on an ERL does not yet exist. Why? For an X-ray ERL as described in these graphs there are two major developments needed. First and simply, recirculation and energy recovery have not been demonstrated at the level of performance required for X-ray ERL facilities. This leads to the question, why is recirculation required at all? Why not dump the beam, as is done in the FEL? At an average beam current of 100 mA and an energy of 5 GeV, the total energy of the electron beam is 500 MW. Without recovering almost all of this energy, the total RF power installed would have to be in the gigawatt range. Recirculation of electrons to regain energy is a must.

In FEL's the energy stored in the beam is not such a problem. The LCLS beam (120 pulses/s at 15 GeV, 3-kA peak current, and 200-fs length) has a total stored energy of about 1 kW. Even the European X-FEL, which aims at up to 10^5 pulses/second, has a total stored energy of about 1 MW.

In addition to the demonstration of energy recovery on a quantitative scale, the development of an X-ray ERL, as well as the realization of FEL designs with megahertz pulse rates, is also hindered by the lack of technical developments as far as gun performance is concerned. Today's guns cannot yet deliver the bunch charges, emittances, and repetition rates required for the full ERL or FEL designs outlined above. Guns capable of delivering a few mA average current are available, but for an ERL to deliver a flux comparable to a storage ring, the average current has to be on the order of 100 mA. However, both these technological goals are quite well defined and within range. Once these are achieved, there will be a very bright future for accelerator-based X-ray sources.

A-1.6 LASER-BASED SOURCES

Overview

Conventional lasers—devices based on stimulated emission from population-inverted media—are the ultimate source for spectral ranges in and around the visible photon energy range. In this range, they provide the highest peak and average powers, in combination with complete and unparalleled control over the electromagnetic field amplitude and phase, from continuous wave (cw) to femto- or attosecond pulses. Polarization is not usually directly controllable in the primary laser process but can in most cases be controlled by propagation through boundaries or birefringent media.

Extending this range toward shorter wavelengths can, in principle, proceed along two complementary routes:

- a) Extension of the laser principle toward the UV and VUV, by use of suitable active materials and population inversion schemes, or
- b) Nonlinear frequency conversion of visible or near-visible laser light.

Extension of the laser principle toward the UV currently ends at ~ 150 nm for commercial instrumentation and ~ 1 – 10 nm for laboratory tabletop lasers, respectively. Physical limitations result from the sparsity of active materials with highly charged ions, lack of tunability, and lack of circular polarization in the soft X-ray range. Practical limitations arise from the pump-power requirements for achieving both population inversion in highly charged ions and gain in the laser process. As elaborated below, at present there are no competitive schemes known to extend the conventional laser mechanism below the 1 – 10 -nm wavelength region. There is, however, a window of opportunity for tabletop X-ray lasers between a few nanometers and a few tens of nanometers with pulse energies above the microjoule level and intermediate repetition rates up to kilohertz for laboratory applications requiring coherent light without tunability, such as for imaging, diagnostics, or metrology.

Nonlinear frequency conversion can be highly efficient with solid-state media, such as optical crystals, which, however, are limited to wavelengths longer than about 200 nm. For shorter wavelengths, one must use HHG from neutral gases, ions in plasmas, or, more recently, frequency conversion from relativistic free or plasma electrons. Most of the frequency conversion schemes for laser-based generation of VUV and X-ray pulses rely on high-power pico- or femtosecond lasers in the visible or near-IR range as drivers. The average power of such lasers is typically in the range of 1 – 10 W. Multiplied by the low conversion efficiency into the UV or VUV, this results frequently in micro- or nanowatts of usable average power, depending on the desired output wavelength.

More recently, the quest for developing laser-based sources for EUV lithography and for materials processing has resulted in the development of pulsed driver lasers in the 100 -W range with pico- to femtosecond pulse lengths. The goal is to reach or exceed average powers of 1 kW.

Sources based on inverse Compton scattering or plasma surface harmonics rely on relativistic frequency up-shifting during the interaction of photons with relativistic electrons, an efficient process when electrons at solid state density are available, as in the case of relativistic plasma surfaces. These high-average-power lasers are capable of reaching or exceeding the intensity limit of relativistic optics, approximately 10^{18} W/cm², which enables new schemes for frequency conversion with high efficiency and a wavelength range extending to several thousand harmonics.

In addition, laser-plasma interaction at relativistic intensities allows for tabletop particle acceleration that could produce gigaelectron-volt electrons. Accelerated electrons of this energy may be used for inverse Compton or plasma surface photon generation, or in combination with conventional undulators or proposed laser undulators to create tabletop free electron lasers. Projects pursuing tabletop particle accelerators and free electron lasers are under way.

Laser-based VUV and X-ray sources have been used around the world for exciting scientific discoveries. Among the foremost are their unique capabilities to generate pulses that can be used to capture the coupled motion of electrons and atoms in real time. Moreover, under the proper generation conditions, the full spatial coherence of the laser-based sources has enabled static and dynamic diffraction and imaging with resolutions of tens of nanometers. This also includes femtosecond time-resolved diffraction studies at multi-keV photon energies.

National and international research planning organizations, such as the European Strategy Forum on Research Infrastructures (ESFRI) and the UK Science and Technology Facilities Council (STFC), are responding to these opportunities by allocating resources at the 100 -M€ level for novel laser-based VUV and X-ray sources, or combinations of lasers and accelerators.

Most laser sources are for single-user laboratory experiments. In contrast to photon and neutron sources with up to 50 simultaneous users, there is as yet no operational laser-based X-ray facility providing X-rays of independently selectable wavelength, bandpass, or polarization with high reliability and stability to many users worldwide. On the other hand, compact and relatively affordable laser-based short-wavelength sources have the potential for providing a relatively large user community with individually adapted light of high quality for special applications. This makes a synergetic coexistence between laser- and accelerator-based VUV- and X-ray sources a foreseeable and fruitful future scenario.

The peak brilliance of various laser-based sources is compared in Figure 39 with accelerator-based sources.

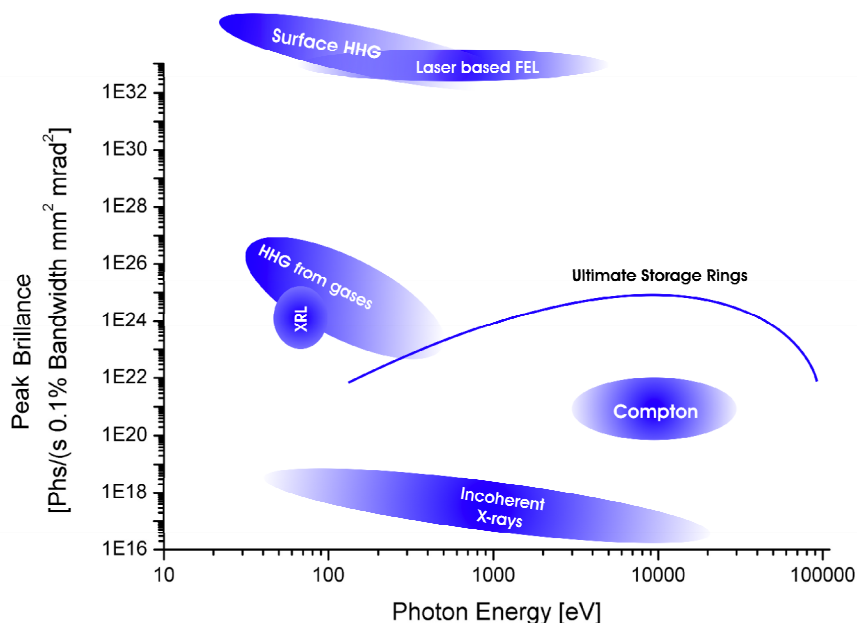

Figure 39 Peak brilliance of laser-based sources in comparison with FEL and storage-ring sources.

Tabletop X-ray Laser Sources

At present, tabletop X-ray lasers, based on population inversion and stimulated emission, offer larger output powers than the most commonly used HHG from gases, both at long wavelengths above 30 nm (using discharge-pumped X-ray lasers) and below 30 nm (using laser-pumped transient inversion schemes). Their output consists of single discrete lines, with spectral purity potentially as high as 10^{-5} , and is nontunable. The practically useful spectral range is likely to be limited to above 1–10 nm; the average output power, to be limited to the megawatt region.

Active materials are usually highly ionized atoms in a plasma, utilizing the fact that atomic transition frequencies scale with the square of the effective charge seen by the active electron. Frequently used ions are Ni-like ions in the $3d^{10}$ configuration, pumped to a $3d^9 4d$ state and lasing down to the $3d^9 4p$ configuration, at wavelengths between 15 nm for Rh ($Z=45$) and 4 nm for Au ($Z=79$). Ne-like ions are used at longer wavelengths, in the range 10–50 nm. Transitions are generally nontunable, with uncontrolled linear polarization. The energy conversion efficiency, pump to output, is typically in the

range of 10^{-5} to 10^{-6} , largely independent of the output wavelength. These efficiencies are higher than present HHG from neutral gases for wavelengths below ~ 30 nm.

Population inversion can be obtained either by radiative recombination, starting from a higher ionized state than used in the transition, inner-shell ionization, or by transient inversion driven by collisions with a dynamically increasing density of hot electrons in a plasma.

Gain is obtained by the SASE principle in an elongated plasma column, or through seeding with HHG light. Problems arise due to strong refraction of the output if the plasma density is not perfectly homogeneous. Gain during the laser process requires pump powers roughly scaling with the inverse 4th power of the X-ray wavelength. At picosecond pump duration, this produces ~ 1 J of pump energy at ~ 10 nm output wavelength, extending to kilojoule energies at 1 nm or megajoules at 0.1 nm. Such pump-pulse energies are difficult to obtain with pump lasers while maintaining reasonable average output powers.

Currently, state-of-the-art tabletop X-ray lasers at 13 nm, with a pulse energy in the multi-microjoule region, ~ 100 -fs pulse duration seeded by HHG, and a repetition rate between 100 Hz and 1 kHz, are under development. Such systems may be attractive for metrology applications in EUV lithography or for many imaging applications, like coherent diffraction or holographic imaging. For these applications, they may complement the portfolio of existing FEL sources and help sustain a growing user community.

High Harmonic Generation from Gases

High harmonic generation from gases occurs through a highly nonlinear frequency conversion process in sufficiently strong, but not too strong, laser fields with intensities around 10^{14} – 10^{15} W/cm² for neutral gases. The unique femtosecond-to-attosecond pulse duration has made it possible to capture the coupled motions of electrons, atoms, and molecules in real time.

In general, the conversion efficiency ranges from approximately 10^{-5} below the 10–50-eV range to approximately 10^{-7} at 100 eV and falls off rapidly for higher photon energies due to lack of phase matching. The generation conditions can be adjusted to emit either discrete harmonic lines or a broadband continuum for applications in spectroscopy and imaging. Recently, elliptically polarized harmonics have been generated from molecules driven by linearly polarized light. The conversion efficiency at each output energy depends on many parameters, such as atomic and molecular properties, ionization and re-collision dynamics, driver laser parameters, and beam propagation in partially ionized gases. These parameters may be adjusted according to the needs of particular applications. Heavier atoms generally have higher conversion efficiencies, by as much as orders of magnitude, but less tuning range toward the blue. Specific output wavelengths or wavelength ranges may be enhanced or suppressed by elaborate driving schemes, such as multi-color drivers, interferences in the ionization dynamics, or adjustment of the driver focus.

The low level of conversion efficiency due to the use of gaseous active media and, more severely, its decrease toward short wavelengths are the most serious drawbacks of this source. In addition, the necessary pump lasers, requiring femtosecond pulses at intermediate intensities around 10^{15} W/cm², are relatively complex systems; however, such lasers are now commercially available with multi-10-W average output powers and the possibility of reaching 100-W or kilowatt powers.

The decrease in conversion efficiency is not fundamental to the HHG process; rather, it results from the large phase mismatch between the harmonic and the driving laser fields above 100 eV. Recent experiments have shown that this phase-matching limit can be extended to 300–400 eV by using longer-wavelength driving lasers in the mid-IR, rather than the usual Ti:sapphire wavelengths of 0.8 μ m. The goal is to phase-match the HHG process at kiloelectron-volt photon energies.

Frequency Conversion by Light Interaction with Relativistic Electrons

The physical frequency-conversion mechanism is either inverse Compton scattering or high harmonic generation from a relativistically oscillating plasma surface. Both approaches exploit the frequency shift of photons interacting with relativistic electrons, which is proportional to g^4 (where g is the dimensionless relativistic velocity parameter of the electrons).

Inverse Compton scattering sources are under development as a dedicated “laboratory” X-ray source in the 10-keV region. The essential requirement, apart from a laboratory-size accelerator reaching several tens of millielectron-volts, is a high-intensity femtosecond laser with high average power, fully synchronized to the accelerator, in order to reach satisfactory X-ray flux despite the relatively low electron flux and interaction cross section. The recent developments in high-average-power diode-pumped femtosecond lasers provide the necessary technology background for such sources, which may reach average brilliances comparable with those of medium-performance storage rings.

High harmonic generation from a relativistic plasma is a novel concept that is potentially capable of delivering very high peak power pulses, in the attosecond range. The method relies on the fact that an ultrahigh-intensity laser incident on a surface immediately creates oscillating plasma electrons at high density. At sufficiently high incident laser intensities, greater than 10^{19} W/cm², the electron motion is highly relativistic, resulting in a substantial frequency shift of the laser light when reflected from the critical electron density. The intriguing features of such sources are manifold; they include a) the use of only one laser to drive the relativistic plasma and, at the same time, provide the fundamental light to be frequency-converted; b) the high density of relativistic electrons, allowing for conversion efficiencies many orders of magnitude higher than in gas harmonics; c) the comparably low drop-off of the efficiency η with X-ray frequency ω , proportional to $\omega^{-5/2}$, reaching up to thousands of harmonics at useful flux; and d) extremely short reflected pulses, down to the attosecond regime. At present, extensive theoretical studies exist, and the first experimental investigations of the frequency conversion process have been undertaken.

In view of the features mentioned above this, may turn out to be a promising way to achieve peak brilliances comparable with those of FELs through frequency conversion of visible light. Theoretically, photon numbers of 10^{16} per pulse at 80-as pulse duration (600-TW power) are predicted in the spectral range 20–70 eV, and 10^{11} per pulse at 5-as pulse duration (6-TW power) in the range above 1.5 keV.

Laser Plasma Acceleration Sources

It has been shown recently that the latest generation of high- and ultrahigh-intensity lasers can be used to accelerate electrons up to gigaelectron-volt energies, and possibly beyond. Several physical mechanisms are currently under investigation, including the bubble acceleration mechanism in plasmas at relativistic laser intensities. In the latter, the ultrashort laser pulse, interacting with a neutral gas or a pre-formed plasma, creates a strong variation of electron densities in its wake—in particular, a roughly spherical depletion region or bubble followed by a high-density region, resulting in a quasi-static potential gradient that follows the incident light. Electrons trapped inside the bubble may be accelerated to gigaelectron-volt energies at moderate laser pulse energies (below 1 J). These electrons can then produce X-rays in conventional undulators or by interaction with a second laser pulse.

Conceptually, the bubble acceleration approach has the potential to enable accelerator-based short-wavelength sources if the persistent problems of electron energy distribution, stability, flux, and reproducibility in the laser acceleration process can be solved. The peak brilliance of this new source could be comparable with that of conventional accelerator-based FELs, while the average brilliance still

needs substantial progress in pulsed-laser technologies to be considered competitive. As with many laser-based sources, the main advantage would not be the replacement of, but rather complementarity with, existing large-scale facilities to benefit a large user community.

APPENDIX 2: NEW SCIENTIFIC OPPORTUNITIES

Advances in many areas of science require the ability to study materials and the interactions of materials, such as a cluster of atoms within the complex matrix of a piece of steel, a chemical reaction at the surface of a catalyst particle, or interactions of two proteins, at the atomic and molecular levels. In addition to static “snapshots,” future scientific challenges require that the dynamics of structure and chemical and physical changes be studied across broad time and spatial domains. Furthermore, many applications demand that these studies be conducted under realistic conditions that include extremes in temperature, pressure, chemical reactivity, photon/particle/ion flux, or electromagnetic fields. This appendix outlines examples of challenging scientific problems in broad areas of science, including energy, environment, medicine, and others, that can be tackled using next-generation ultraviolet and X-ray light sources. While each section is focused on one topical area, there is extensive overlap in the examples from materials, chemical, biological, geological, environmental, and life sciences, reflecting the broad impact next-generation light sources will have on future scientific advances.

A-2.1 REVOLUTIONARY MATERIALS WITH TAILORED FUNCTIONALITIES FOR NEXT-GENERATION ENERGY TECHNOLOGIES

Future systems for energy production, storage, and use—such as batteries, photovoltaics, fuel cells, and others—are critically dependent on the development of new materials that have revolutionary new properties and can meet demanding performance requirements. To realize these new materials requires being able to observe the evolution of materials structure and properties with high spatial and temporal resolution under realistic operating conditions.

The controlled synthesis of advanced materials with designed architectures and tailored functionalities is one of the grand challenges identified by the Basic Energy Sciences Advisory Committee (BESAC) [1] and cuts across many of the Basic Research Needs (BRN) workshop reports [2]. New materials having new properties to meet demanding performance requirements are critical for the development of future systems for energy production, storage, and utilization. To fabricate or synthesize these new materials requires being able to observe and follow the evolution of materials structure and properties at high spatial and temporal resolution—including observing the formation mechanisms of desired phases, determining the nanoscale structure of nucleation sites, and following the dynamics of such phenomena on sub-picosecond to second time scales. Developing new analytical capabilities to observe the processes that occur during materials synthesis *in situ* is essential if we are to achieve the fundamental understanding that will enable transformation of today’s Edisonian approach to new materials into targeted discovery and development of new materials through design and control of materials structure and processes. As emphasized in many of the BRN workshop reports (for example, see *Basic Research Needs for Materials under Extreme Environments* [2]), there is a cross-cutting need for understanding the effect of specific defects on the performance of a material or device. The ability to observe the evolution of defects and other nanostructural features of a material under operational conditions would enable unprecedented understanding of the role of such features in materials performance. Next-generation ultraviolet and X-ray light sources offer exciting opportunities to characterize materials and to observe atomic- and molecular-level processes under realistic conditions and in real time. The ability to observe *in situ* the processes that occur during synthesis of advanced materials, and during the functioning of devices, is critically important. Many analysis techniques cannot be applied to samples in the environments that these samples typically encounter—non-vacuum, reactive, or high-temperature environments. Coherent hard X-rays can penetrate the typical synthesis environment or device structure and analyze, in real time, the nanoscale structures and defects controlling the dynamics of synthesis or device performance.

Current state-of-the-art *in situ* X-ray studies of synthesis typically use diffraction or spectroscopy from millimeter-scale regions to observe the average properties of, for example, the growing surface of an epitaxial film (Figure 40). Recent studies [3, 4] of growth of such metastable phases as InN, desired for solid-state lighting and photovoltaic applications, find intriguing behavior, such as spatio-temporal oscillations between competing phases, as shown in Figure 41. New coherent X-ray sources would allow imaging of the atomic structure and composition of critical features underlying such complex synthesis processes, such as atomic surface steps, nanoscale islands, and nucleation centers. The ability to observe these features in real time on relevant time scales, from nanoseconds to seconds, will revolutionize our understanding of the growth of metastable materials by chemical routes and pave the way for new approaches to materials synthesis under conditions that are far from equilibrium. Below, additional examples are discussed that provide insight into the revolutionary advances in materials science that could be made possible with next-generation light sources.

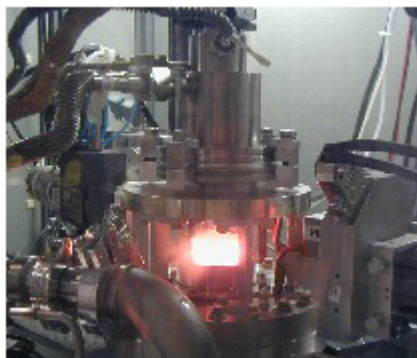

Figure 40 *In situ* X-ray study of (In,Ga)N growth in the high-temperature, reactive environment of metal-organic chemical vapor deposition.

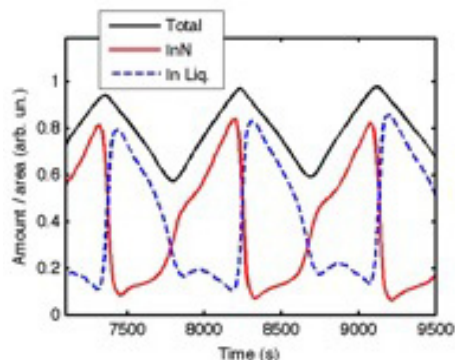

Figure 41 Amounts of InN and In liquid on the surface as a function of time, as determined by *in situ* X-ray diffraction and fluorescence. The oscillating chemistry reflects feedback between surface-catalyzed NH_3 decomposition and the phases present [5].

Understanding Photon-matter Interactions for Energy Applications

The creation of materials that optimize the conversion of photon energy into other forms or vice versa is critical for next-generation energy technologies, such as solar energy and solid-state lighting. This requires an understanding of properties of the dynamic electronic structure of complex materials on the nanoscale. For example, understanding the dynamic structure-property relationships in organic semiconductors may permit the optimization of energy transfer pathways to yield more efficient solid-state lighting or photovoltaic devices. Such understanding may enable the design of molecules with predictable reaction pathways that will suppress any tendency for decomposition on excitation, a primary obstacle to low-cost, organic efficient energy-conversion devices. The overall goal is the creation of actively controllable and tunable materials with multifunctional, broadband electromagnetic response.

For energy applications, it is important to design and develop novel materials that efficiently capture solar photons in excited electronic states, as well as convert the electronic excitations into usable energy. To achieve these goals, we will need to understand, control, and optimize such photon-material interactions as absorption, transmission, and propagation; charge and energy transfer and transport; and the conversion of electronic excitations into optical signals or electrical energy. Many of the important

processes occur at the interfaces between disparate materials, so that the characterization, understanding, and optimization of interfacial processes in materials are essential.

An understanding of the properties of dynamic electronic structure of complex materials on the nanoscale will be essential for understanding both charge and energy transport and electronic relaxation pathways in complex electronic materials. Ultimately, the goal is to understand spatially-resolved, dynamic electrical and dielectric properties in terms of the density-of-states and electronic structure of occupied-core and partially occupied-valence states. This knowledge base will allow us to design and optimize materials for photon-matter interactions and energy and charge conversion.

The combination of ultrashort, coherent extreme ultraviolet pulses and angle-resolved photoemission spectroscopy can be used to characterize and control the nature of electronic structure and dynamics of complex materials. High-resolution ARPES maps both the energy and momentum of electronic states, providing unprecedented insight into the electronic structure of solids. For the study of electron dynamics in materials, pump-probe experiments are carried out with a single femtosecond laser source that is split into a pump and probe beam, the optical photons of which are then up-converted to energies required for photoemission. The required excitation or pump pulses are relatively energetic (~ 1 mJ/pulse), ultrafast (10 fs–10 ps) photon pulses, tunable from the terahertz region through the near-ultraviolet, which create nonequilibrium states of the material. For the time-delayed ARPES pulses, a synchronized ultrafast pulse (10 fs–10 ps) with an energy tunable from the ultraviolet to soft X-rays (6–300 eV) is needed. High repetition rates, from 100 kHz to 10 MHz with photon fluxes of $\sim 10^{14}$ /sec, are required to avoid space-charge effects while yielding a reasonable spectrum.

As an example, carbon-based (organic) materials offer unique properties to control the efficient interconversion of optical and electronic energy (Figure 42). Closely related classes of organic molecules offer the potential to convert sunlight into electricity in organic photovoltaic devices, as well as electricity into high-quality white light for efficient solid-state lighting. In both cases, carbon-based materials have the potential for large-volume, low-cost manufacturing; however, the complex materials systems remain poorly understood at the molecular level, and achieving extended operating lifetimes is a primary challenge. In addition, the strong localization of electronic states on individual molecules or even moieties within molecules means that the relative orientation of nearest neighbors has a strong effect on both energy transfer and charge transfer. High spatial resolution, on a nanometer scale, is therefore desirable to fully characterize the materials.

Closely related to these challenges is the strong coupling between electronic and vibrational modes, which leads to a significant rearrangement of the molecular structure when either a photon or an electron interacts with the molecule. The new structure may include changes in bond length, which can affect the subsequent branching of energy flow into radiative and non-radiative modes, or may lead to intermediate chemical bonding configurations from which a return to the original ground state is not possible. In this respect, organic

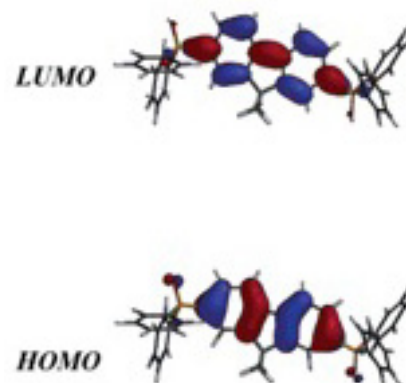

Figure 42 Computed highest occupied and lowest unoccupied (HOMO and LUMO, respectively) orbital amplitude plots (B3LYP/6-31G*) of an electron-transporting organic molecule made by 2,7-disubstitution of a dimethyl fluorene bridge with diphenylphosphine oxide (PO6), showing the localization of the electronic states. The relative positions of adjacent molecules, even in a macroscopically amorphous film, can therefore dramatically affect electron and energy transport. From A.B. Padmaperuma *et al.*, *Chem. Mater.* **2006**, *18*, 2389-2396.

semiconductors bridge the disciplines of physics and chemistry, since optoelectronic excitations are intimately linked to chemical transformations.

This strong electron-vibration coupling makes it challenging to achieve predictive control of the energy pathway after an initial excitation. State-of-the-art X-ray absorption spectroscopy has been used to determine the steady-state ground and excited state geometries of an organometallic complex in solution, but similar measurements on devices in the solid state with sufficient time resolution to follow the evolution of induced vibrational modes remain out of reach. Such measurements will require photon pulses in the 10-fs range, with the ability to synchronize with a variety of pump modes, including different optical frequencies to excite either electronic or vibrational modes. In real devices, the region of interest will be an interface buried beneath organic charge transport layers or metal electrodes, and the materials themselves will be susceptible to damage from the intense photon beam from a light source. Either ultrashort, intense pulses that extract useful information before degradation occurs or broader, coherent beams coupled with innovative collection technologies, allowing structural data to be reconstituted from the speckle pattern and known information about molecular structure, should be considered.

Another class of materials that may be useful for optical-electronic energy conversion is electromagnetic metamaterials, structured composites with patterned metallic sub-wavelength inclusions (Figure 43). These mesoscopic systems are built “from the bottom up,” at the unit cell level, to yield specific electromagnetic properties. Individual components respond resonantly to the electric, magnetic, or both components of the electromagnetic field. In this way, electromagnetic metamaterials can be designed to yield a desired response, such as negative electric response or negative refractive index, at frequencies from the microwave through the visible. Additional design flexibility is afforded by the judicious incorporation of naturally occurring materials within the active region of the metallic metamaterial elements.

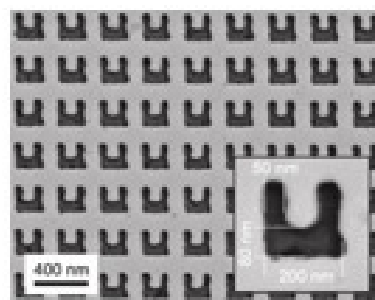

Figure 43 Metamaterial with negative index at near-infrared frequencies (Enkrich *et al.*, PRL **95**, 203901 (2005)).

In addition to conversion of photonic into electrical energy, there are critical scientific challenges in solar energy and solar fuels generation, as outlined in the DOE workshop on *Basic Research Needs for Solar Energy Utilization* [2]. Such processes require coupling ultrafast, single-electron, excited-state photochemistry in molecular photosensitizers to catalysts for generating chemical fuels via multi-electron reactions using transition-metal complexes. This coupling must be done in a way that avoids excited-state free-energy loss, quenching, and reverse chemical reactions. It must also ultimately be accomplished using renewable, naturally abundant materials. Nature has already achieved the goal of efficient solar-initiated water splitting coupled to reductive chemical-energy storage using abundant, renewable, self-assembling “soft” materials. However, progress in developing solar-energy-converting synthetic materials is currently limited by the lack of information on time-dependent photoexcited-state electronic and coordinate-structure changes and the lack of understanding of how these structural dynamics are linked to energy-conserving chemistry (see Figure 44).

The development of advanced light sources for dynamic structure determination would create opportunities for ground-breaking discoveries of the chemical processes that underlie solar-energy conversion across the full range of biological, organometallic, and inorganic photocatalytic materials. It would also provide a strategy to accelerate solar-fuel catalyst development by enabling information on structure-dependent, excited-state energy-conversion processes to be included in synthetic design.

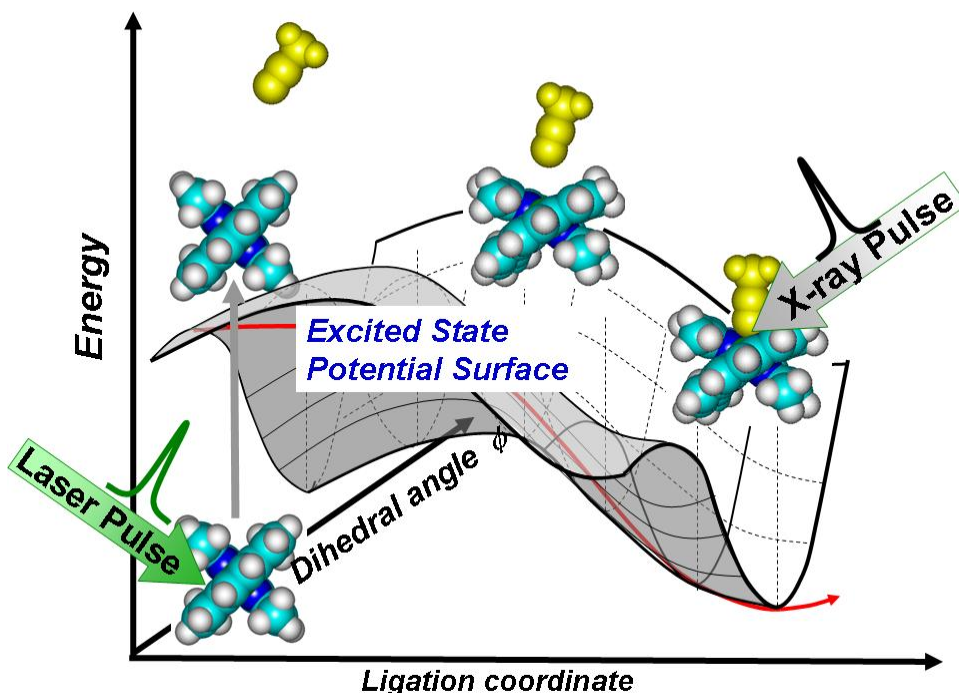

Figure 44 Structural dynamics of a photoactive copper complex excited state created by green laser pulses followed by X-ray pulses to capture both dihedral angle movements on 100-fs time scale and ligation coordinate changes on ps to ns time scale. [Chen et al., *J. Am. Chem. Soc.* **124**, 10861-10867 (2002); **125** 7022-7034 (2003); **129**, 2147-2160 (2007)]. This research may guide synthesis in finding low-cost, first-row transition metal complexes to replace precious metals in solar energy conversion processes.

Particularly significant would be the development of advanced light-source facilities with capabilities for photoexcited-structure mapping using short-pulse X-rays across a broad X-ray energy range. These sources would enable tunable hard X-ray energies for combined high-resolution spectroscopy and anomalous-scattering experiments; high-energy pulsed X-rays for high-resolution, time-resolved pair distribution function (PDF) analyses; low-energy X-rays for time-resolved electronic structure analyses of the complete first-row transition metals and sulfur ligands; and continuously tunable, ultrafast 2-D IR techniques extending into the far infrared and terahertz regions of the electromagnetic spectrum for directly measuring functionally critical vibronic and electronic coupling of the photosensitizers and active sites to their environments.

Understanding and Control of Quantum Materials at Characteristic Energy, Time, and Length Scales

The discovery of new functional materials will be enabled by understanding key electronic phenomena for energy generation, conversion, storage, and utilization. This knowledge will be achieved by probing electronic structure with unprecedented space, time, spin, and energy resolution.

Bloch's theorem, which describes the motion of independent electrons, provided the basis for the semiconductor revolution of the last half-century. The next revolution will likely require a new formulation of electronic behavior to describe the many-body effects ubiquitous in complex materials (see Figures 45 and 46). Critical information obtained from next-generation light sources will be essential in

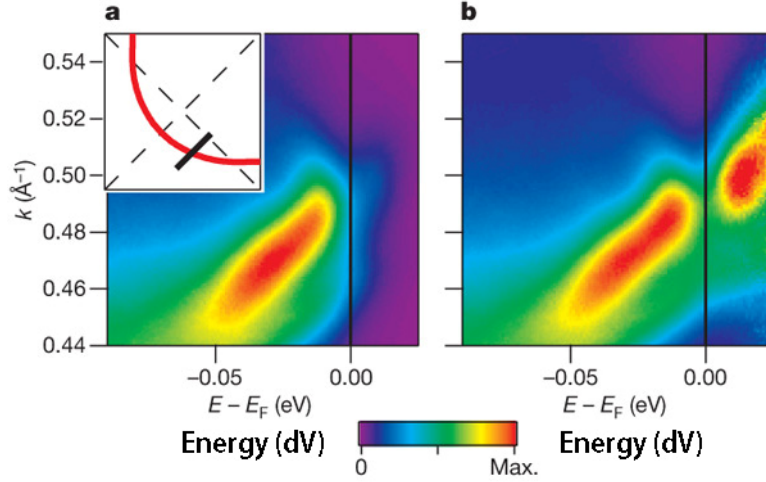

Figure 45 Spectral plots showing the intensity of photo-emitted electrons as a function of energy and momentum. a) shows the spectral intensity as recorded, and b) shows the spectral intensity after analysis, allowing observation of states both below and above the chemical potential. After analysis, the complete dispersion of the Bogoliubov quasi-particles associated with the superconducting Cooper pair is evident. From H.-B. Yang, J.D. Rameau, P.D. Johnson, T. Valla, A. Tsvelik, G.D. Gu, *Nature* **456**, 77-80 (2008).

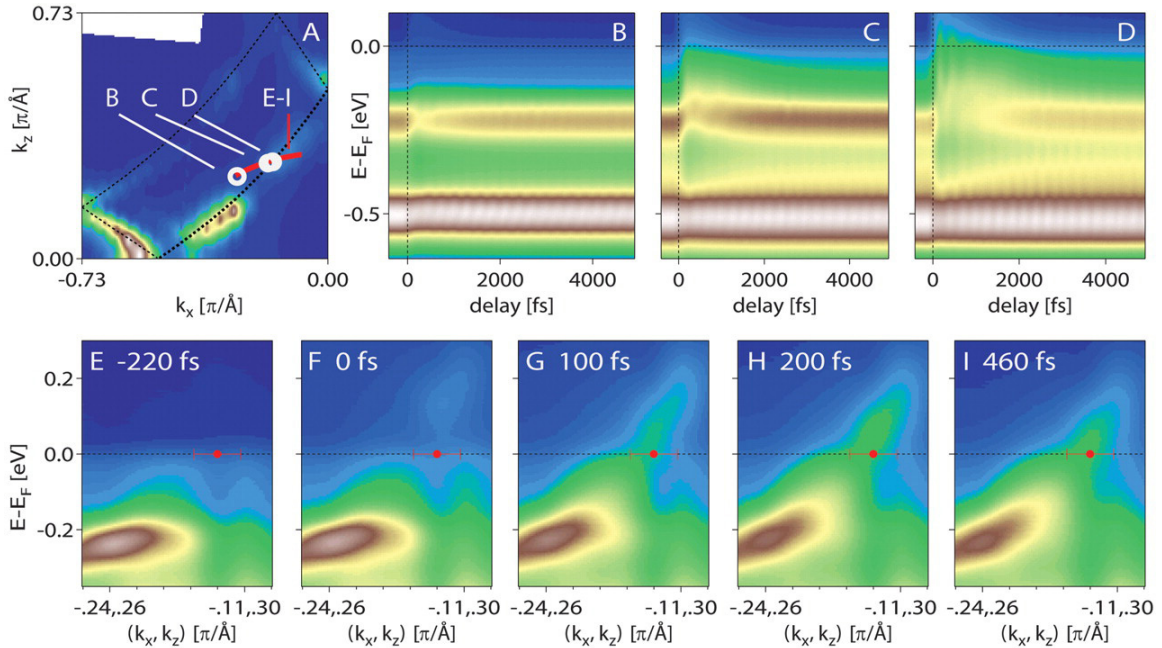

Figure 46 Illustration of time-resolved ARPES experimental data from the charge density wave state in TbTe3 [F. Schmitt, P.S. Kirchmann, U. Bovensiepen, R.G. Moore, L. Retting, M. Krenz, J.-H. Chu, N. Ru, L. Perfetti, D.H. Lu, M. Wolf, I.R. Fisher, Z.-X. Shen; Effect of the Amplitude Mode and the Transient Melting of the Charge Density Wave on the Electronic Structure of TbTe3; *Science* **321**, 1649 (2008)].

the development of this new theoretical formulation. X-ray techniques can be used to provide information that will help us to understand, predict, and control the electronic structure and dynamics underlying the functionality of complex materials. This will enable the understanding of emergent phenomena, such as collective excitations resulting from the coupled degrees of freedom and competing ground states. This new understanding will enable the design and control of transition metal oxides and related complex materials and their interfaces for new functionalities, including higher-temperature superconductivity, more efficient solar cells, high-performance thermoelectrics, solid-state fuel cells, and efficient hydrogen production.

Next-generation light sources will provide high beam intensity to examine low-energy coupled excitations with 1-meV resolution, using both non-resonant and resonant inelastic X-ray scattering; greatly improved coherence and photon intensity to enable nonlinear X-ray scattering (such as 4-wave mixing) to provide information on valence correlation across different atomic sites; much higher flux density to enable spin-ARPES and nano-ARPES with 1-meV resolution; and shorter photon pulses to access fundamental time scales from 1 fs, characteristic of electron correlations, to hundreds of femtoseconds, characteristic of coupling to lattice modes.

To fully understand the mechanisms central to high-temperature superconductivity and other correlated electron phenomena, highly precise information on the behavior of electrons is required. This includes detailed information about the important quantum parameters: energy, momentum, space, time, charge, and spin. While thermodynamic and transport measurements provide much information about these parameters, deep insights have often come from scattering, spectroscopy, and imaging. Two classes of photon-based spectroscopies will greatly enhance the ability to obtain a fundamental understanding of the correlations involved. The first involves an incoming photon and an outgoing electron (photon-in/electron-out)—advanced versions of ARPES that are spin-resolved or time-resolved. These require much brighter sources than are now available. Similarly, pump-probe ARPES methods, which use a laser “pump” to drive the material out of equilibrium and then use an X-ray “probe” beam to study how the electrons relax back, will also require much brighter light sources. Greater brightness will also be necessary to realize the potential of coincidental ARPES measurements involving the simultaneous measurement of more than one electron, which can give direct information on electron-electron correlations.

The second class of photon-based spectroscopy involves an incoming photon and an outgoing photon (photon-in/photon-out), including inelastic X-ray scattering, coherent X-ray scattering, X-ray dichroism, and photon correlation spectroscopy. Inelastic X-ray scattering would provide critical information on the charge fluctuation in the material, analogous to what has been determined for the spin fluctuations by inelastic neutron scattering. Much brighter X-ray sources and exploitation of resonant techniques will be necessary for inelastic X-ray scattering to achieve the sensitivity and resolution needed to address key problems of correlated behavior, such as superconductivity.

In addition, the discoveries of novel quantum phenomena, such as relativistic Dirac fermions in graphene, Berry phases, the quantum spin Hall effect in topological insulators, dissipationless spin currents in spin Hall materials, and fractional statistics, have revealed fundamental new physics that may, over time, become valuable in addressing energy grand challenges. The recently discovered topological insulators are band insulators that obey Bloch’s theorem but violate Maxwell’s equations in their standard form. More than a dozen different three-dimensional topological insulators are possible. In theory, all such materials will exhibit exotic electromagnetic and quantum properties on their surfaces. So far, only two have been discovered in heavy-atom materials, such as BiSb and Bi₂Se₃, and one lower-dimensional version in MBE-grown and engineered, HgTe-based quantum well structures. ARPES is highly suited to study the topological surface states in the Bi-series, which exhibit quantum Hall-like effects without

magnetic field (Figure 47) as well as quantum entanglements (Berry's phase), as recently revealed by spin-ARPES (Figure 48).

A quantum Hall-like effect without a magnetic field opens up the possibility for truly dissipationless spin currents, which could save energy in devices, and surface quantum entanglement opens up the possibility of new topological quantum computing schemes. Present-day topological quantum computing schemes depend on unusual fractional quantum Hall states that exist only at very high magnetic fields and at extremely low (millikelvin) temperatures. Topological insulators can, in principle, help realize these schemes without having to apply a magnetic field and operating even at room temperature. Quantum computing could allow a transformation from bit-based information to multi-dimensional information manipulation with low energy dissipation. Quantum computers are unlikely to be advantageous for all problems, but for some, like predicting the dynamic evolution of the complex quantum systems involved

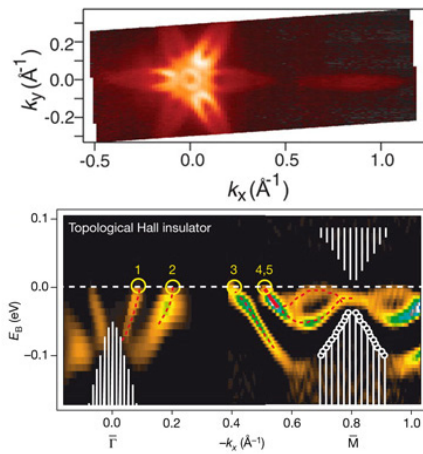

Figure 47 A topological Dirac insulator in a quantum spin Hall phase. An odd number of surface states in between two Kramer points is observed in a bulk Dirac insulator BiSb, where the band gap (the Dirac mass) is due to spin-orbit coupling. This confirms the existence of a topological order in the material. From D. Hsieh, D. Qian, L. Wray, Y. Xia, Y. Hor, R.J. Cava and M.Z. Hasan, *A Topological Dirac insulator in a Quantum Spin Hall Phase*, Nature **452**, 970 (2008).

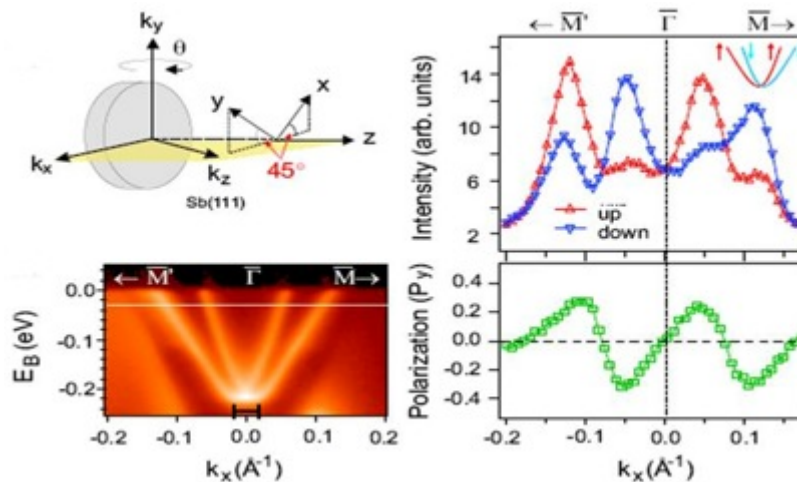

Figure 48 A spin-resolved ARPES measurement of topological surface states. The degree of spin polarization and the angle of spin canting over the time-reversal-invariant momenta can be determined from spin-ARPES measurements, which show that the BiSb class exhibits nontrivial topological Berry's phase. Topological Berry's phase is the key element for quantum computing. From D. Hsieh, D. Qian, L. Wray, Y. Hor, R.J. Cava, M.Z. Hasan, Science **323**, 919 (2009).

in catalysis and energy conversion, they may be much more efficient than classical computers. The understanding and control of topological insulators will be possible only with the advent of next-generation photon sources. Understanding of topological phases associated with the electronic structure at the boundaries of quantum materials constitutes a key experimental challenge. The measurement of complete spin orientation is needed to understand and control quantum phases. The availability of high photon flux and resolution would make ~ 1 -meV resolution ARPES and spin-resolved ARPES with 3-D imaging of the spin degrees of freedom possible, and it would likely revolutionize the field of topological insulators. Complete spin information would allow unique determination of the quantum phase at the boundary of these materials, which can then be designed for manipulation and further processing. To study such interfaces, resonant elastic scattering and inelastic X-ray scattering with ~ 1 -meV resolution, full polarization control, and the possibility of pump-probe time-resolved experiments would be highly desirable.

Probing Nanostructures and Nanoparticles with High Spatial Resolution

Nanoscale structures, such as quantum dots, nanotubes, nanoparticles, and nanocapillaries, present special challenges for analysis. The ability to probe the structure of these materials, characterize the interfaces of these materials with their environments, and study the dynamics of reactions at these interfaces is a grand challenge for photon science.

Quantum dots and other nanostructures for solar conversion. To utilize solar power for the production of electricity and/or chemical fuel, such as hydrogen, methane, or alcohol, on a massive scale, it will be necessary to develop solar-energy conversion systems that combine very high efficiency and low capital cost to produce solar power that is competitive with the cost of energy from coal. One potential approach for increasing solar cell efficiency is to utilize nanostructures, such as quantum dots, that use quantum confinement to control the relaxation dynamics of photogenerated electron-hole pairs (excitons). This could yield either enhanced photocurrent through efficient multiple exciton generation or enhanced photopotential through hot-electron transport and transfer processes (see Figure 49). To realize these desirable effects, it is necessary to determine and control the dynamics of hot-electron and -hole relaxation, charge transport, and interfacial charge transfer. For example, thermalization of high-energy carriers is suppressed by a phonon bottleneck produced by the large energy separation of the nanomaterial's quantized levels. The critical dynamic processes have characteristic lifetimes ranging from femtoseconds to nanoseconds, and their magnitudes are extremely sensitive to the nanomaterial and its interfacial properties.

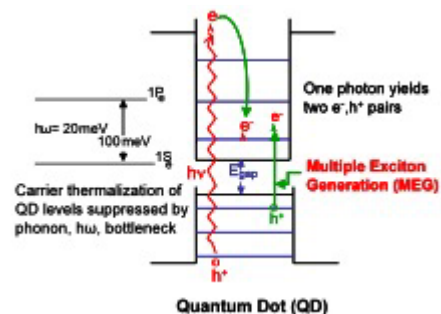

Figure 49 Multiple exciton generation in semiconductor quantum dots. In QDs, the absorption of one incident photon can lead to the creation of more than one electron-hole pair. MEG is an inverse-Auger process, which is enhanced in a QD by quantum confinement and the relaxation of the requirement to conserve momentum. Furthermore, thermalization of high-energy carriers is suppressed by the phonon bottleneck produced by large energy separation of quantized levels. A.J. Nozik, *Physica E* **14**, 115 (2002).

Recently, it has been predicted that MEG may be an efficient process in QDs [5]. Efficient and ultrafast multiple exciton generation from absorbed single high-energy photons has been reported in Group IV-VI, II-VI, and III-V semiconductor QDs and, recently, in Si QDs [6]. MEG has the potential to overcome the Shockley-Queiser thermodynamic limit of 32% for photovoltaic energy conversion. However, recent experiments show that the quantum yield for MEG, both in isolated QDs in colloidal solutions and in QD films consisting of QD arrays used in solar cells, is very sensitive to the chemistry at the QD surface and

the interfacial properties of electronically coupled QDs in the QD arrays (Figure 50). Thus, the MEG quantum yield can vary from zero to the formation of three excitons per absorbed photon, depending upon the chemical treatment of the QD array or the specific chemical synthesis route of the QDs via colloidal nanocrystals.

Therefore, understanding the QD interface—in particular, its chemical state—is crucial. Furthermore, it is necessary that this be done on individual QDs because of variations in properties from one dot to another. It is important to understand clearly the chemical state of the quantum dot's surface and its relation to solution composition and temperature, preparation conditions, and variation with time. This can be done conveniently via single-particle XPS. However, the small size of the nanoparticle and the realities of the X-ray background make this measurement such a demanding task that it requires a fourth-generation light source.

Nanostructured Materials for Electrical Energy

Nanostructured materials offer significant opportunities to improve electrical energy storage efficiency because nanoscale architectures can be designed to optimize energy storage and materials stability. However, realizing this potential requires new understanding of key factors that limit performance in these complex, dynamic systems. Next-generation light sources would provide key insight into materials properties and interfacial chemistry required for advanced batteries and capacitors.

Electrical energy storage using batteries and capacitors is critical to a wide range of applications, but it is particularly important for transforming transportation from an oil-based to an electrical-energy-based technology. Today's advanced battery technologies employ nanophase materials, such as Li-based compounds, shown schematically in Figure 51. Nanoscale materials are particularly attractive because of their ability to reduce internal mechanical stress during charging; such stress is a major cause of battery failure. It is estimated that improvements by a factor of 5 or more in electrical energy storage efficiency in batteries are needed. This enhancement demands a fundamentally new understanding of the factors that limit battery performance, and these factors are at the very frontier of materials and chemical characterization, including the complexity, heterogeneity, particle size, and defects in the materials under diverse extreme conditions, such as chemical gradients, as a function of time. Several general features are desirable in investigating heterogeneous materials. For example, simultaneous real-time imaging of changes in chemistry and atomic arrangements in real systems is important, with a time resolution appropriate for the process of interest, typically ~1 ms to 1 min. New approaches are needed to follow these complex processes, especially under actual operating conditions. These include *in situ* measurements of atomic arrangements, using combined X-ray scattering and absorption techniques, under severe chemical gradients; combined hard X-ray microdiffraction and

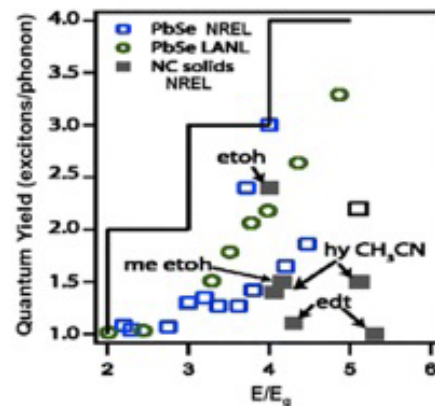

Figure 50 Semiconductor quantum dots can show high quantum yields for generating multiple excitons per absorbed photon. However, the efficiency of the MEG process is sensitive to QD surface chemistry (indicated above). Advanced light sources can yield ways to control surface and interfacial effects.

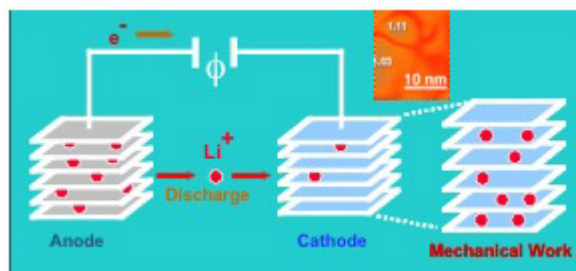

Figure 51 Nanoparticles or nanophase material can be used in advanced batteries, where their resilience to battery charging can enhance battery performance. The inset shows nanophase tetragonal $\text{Li}_2\text{Mn}_2\text{O}_4$ (image courtesy of Yet-Ming Chiang).

fluorescence for simultaneous identification of phase, composition, and contaminant sorption on the nanometer to micrometer scale; time-resolved and *in situ* measurements of reaction pathways and kinetics combined with measurements to determine chemistry or local structure; and combined SAXS/WAXS/PDF to simultaneously explore nanomaterials on Ångstrom-nanometer-micrometer length scales during particle nucleation/ripening/growth and transformation.

X-rays are useful because they penetrate samples too thick for electron microscopy. Coherent imaging that requires no X-ray lenses has the ability to resolve ultra-small sample features. The technique exploits coherent scattering from structures that need not include periodic substructure. Imaging is achieved by iterative reconstruction of the local density distribution at the sample, assuming the phase shift from the surrounding environment is known. Coherent imaging is advancing rapidly; with today's third-generation X-ray sources, it can achieve spatial resolutions of ~5 nm. Future X-ray sources will extend the achievable spatial resolution below 1 nm. In addition, recent developments have illustrated tiling of measurements from overlapping regions to increase the field of view and have demonstrated sensitivity to strain and defects in crystal structures. The technique requires coherent X-rays, and focusing can be used to increase the flux density in small volumes. The achievable spatial resolution improves as coherent flux to the inverse fourth power. Extrapolating from demonstration experiments, a coherent dose of about 10^{14} photons in a 10×10 nm² beam should be able to record an image with a true atomic resolution of ~0.2 nm. Instrumentation that has a 10-nm beam size and 0.2-nm spatial resolution is well-suited to study nanoscale structures of importance for batteries, hydrogen storage, and other energy materials. *In situ* and structure evolution experiments are possible and extremely desirable for energy applications, but they will require specially designed samples and further advances in experimental techniques. For example, the ability to record images with a time resolution of seconds or faster would be very desirable. Either sufficiently high time-averaged brightness or sufficiently high peak brightness in a pulsed source would be necessary. Sample damage in these experiments due to the high photon flux is a major concern.

Understanding and Controlling Materials under Extreme Conditions

Future energy technologies will demand enhanced, reliable materials performance even though they are exposed to extremes in thermomechanical, chemical, radiation, and electromagnetic environments. Materials must show minimal fatigue, corrosion, degradation, and failure over time. The ability to study materials in extreme environments will provide the fundamental knowledge required to address and solve these problems and produce revolutionary new materials with novel properties for energy production, storage, conversion, and transfer that are superior to any known materials existing today.

New materials for future energy technologies will have to perform well under conditions of high photon, particle, or radiation flux; temperature; pressure; stress or strain; chemical corrosivity; and other extremes. The ability to operate under these extremes can improve performance efficiency, reliability, and lifetime of materials required for future energy technologies. Materials respond to extreme environmental conditions by time-dependent transformations, defect formation, defect migration, and aggregation, resulting in structural and property changes over broad length and time scales. These dynamic processes, initiated at the nanoscale and at interfaces, evolve in response to the multiple extreme environments in which they are immersed. Understanding these dynamic processes is essential for developing predictive models of long-term behavior that will affect next-generation materials for nuclear energy, transportation, solar cells, batteries, steam generation, power transmission, hydrogen storage, and other uses.

Today we have very limited understanding of how extreme environments affect a material at the atomic and molecular levels and how these nanoscale interactions initiate the cascade of events that ultimately result in materials degradation and failure. Capabilities inherent in next-generation X-ray sources, in concert with extreme conditions, are needed to probe the electronic, structural, and dynamic properties of

materials under extreme environments. A new generation of ultrafast, brilliant photon sources, partnered with new pump-probe tools and specialized chambers for establishing controlled extreme environments, would provide new insight into materials behavior that could usher in new classes of materials with unprecedented performance capabilities. *In situ* observations during exposure to extreme environments offer an unparalleled opportunity to explore the events controlling materials behavior. An understanding of the evolution of material responses, from atomic defects to macroscopic properties and at time scales ranging from 10 fs (see Figure 52) to geologic times, will allow the development of models to predict transformations in functional materials required for future energy systems.

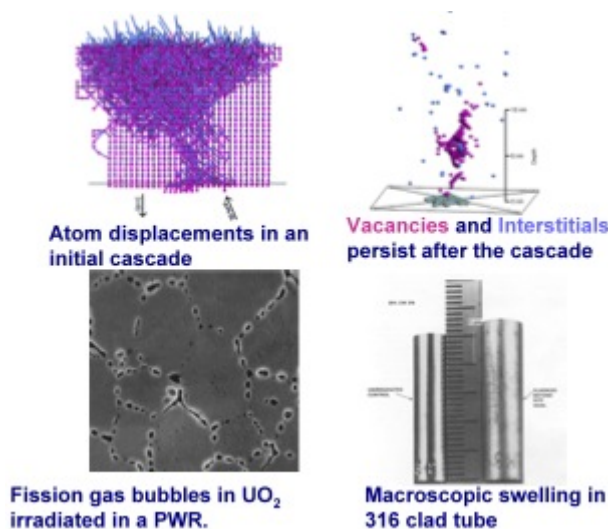

Figure 52 Dynamic processes in nuclear materials.

Time-resolved observation of material phenomena, such as phase transformations, defect generation, migration, and coalescence, and chemical reactivity in real materials, is essential for detailing and developing the predictive capability that will allow us to obtain enhanced performance in existing materials and create new and better materials. For example, investigation of ion displacement-collision cascades using a pulsed ion source in an X-ray end station could address how many lattice vibration periods are required for a material to approach quasi-equilibrium. Once this information is in hand, it could be utilized to develop improved radiation-resistant materials for future advanced nuclear energy systems, on the basis of firm scientific principles rather than empirical data. A transformational advance in scientific knowledge is possible by coupling an ultrafast, ultra-brilliant photon source with environmental chambers and additional tools, such as pump beams that create excited states, enabling *in situ* interrogation of materials behavior under extreme conditions. Developing predictive models requires X-ray sources capable of resolving the time evolution of material microstructure, such as defects, grain boundaries, and dissipation of dose effects, simultaneously with the transient triggering event (for example, the formation of a collision cascade by neutron, alpha, beta, or gamma irradiation). These characterization tools must be able to diagnose defect type, concentration, and motion, as well as material phase, density, and temperature; they also must have the ability to discriminate chemical changes under the extreme conditions in which the materials will be employed.

The primary sources of damage in nuclear and ion irradiation environments are atomic “displacement-cascades,” which deposit several tens of kiloelectron volts of kinetic energy within a length scale of ~10 nm over a time scale of ~1 ps (Figures 52 and 53). An improved understanding of the temporal

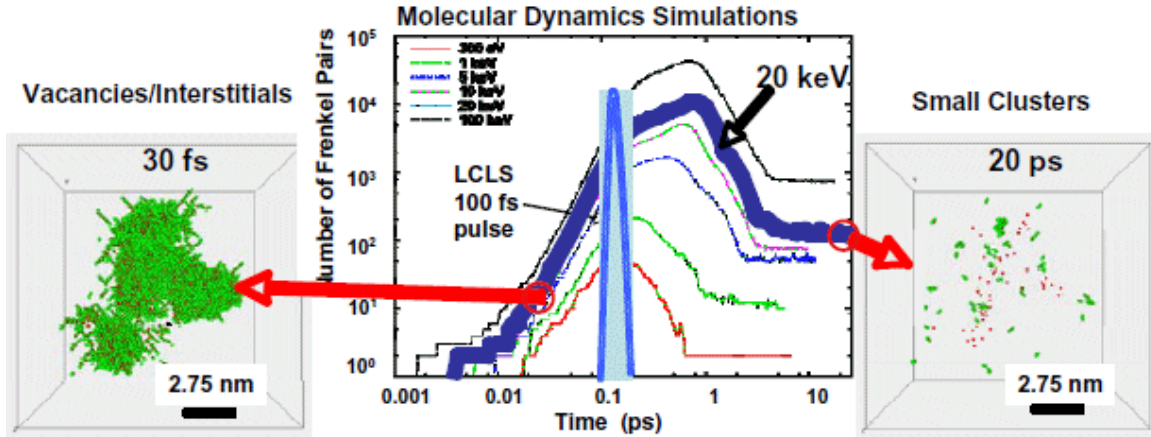

Figure 53 Molecular dynamics simulations of defect evolution for a 20-keV displacement cascade in iron at 100 K, indicating the initial cascade at 0.03 ps (left) and the surviving defect configuration after 20 ps (right). The center panel highlights the time evolution of vacancy-interstitial pairs (Stoller).

evolution of the resulting point defects and small vacancy and interstitial clusters on picosecond time scales is critical because this is the cause of the residual structural damage. Computer simulations offer a way to gain insight into displacement-cascade dynamics (Figure 53), but present-day molecular dynamics simulations are intractable beyond the nanosecond regime if the electronic structure is included (unlike classical molecular dynamics). The improved treatment of electron correlation, local melting, shock waves, and thermal transport are frontier areas of current molecular dynamics research.

Detailed time-resolved experimental measurements of the structural dynamics of collision cascades are critically needed on all time scales. The coupled requirements of nanoscopic length scales and picosecond time-scale resolution associated with collision cascades have prohibited existing structural X-ray probes from addressing their complex, short-lived dynamics. Having short, brilliant pulses is critical for collecting full diffraction patterns from transient cascade structures. Figure 53 indicates that the time scale of the cascade initiation phase is actually in the 20-fs range. Thus, pulse lengths an order of magnitude shorter than currently available or planned, but with at least as many total photons per pulse, are needed.

Producing new materials using extreme conditions. Understanding how extreme conditions interact with materials at the atomic and molecular levels opens the door to using these extreme conditions to produce new materials. For example, photon fluxes can be turned into a tool to create new materials and structures, and to drive materials into new thermodynamic states. Careful exposure of silicon to a plasma generated by femtosecond laser irradiation in a SF₆ environment can produce conical structures in which a highly non-equilibrium phase exists in the near-surface region (Figure 54). The surface is enriched in S (>1 atomic %), a chemical change that creates “black” silicon, which is remarkably absorbing over nearly the full optical spectrum, even at

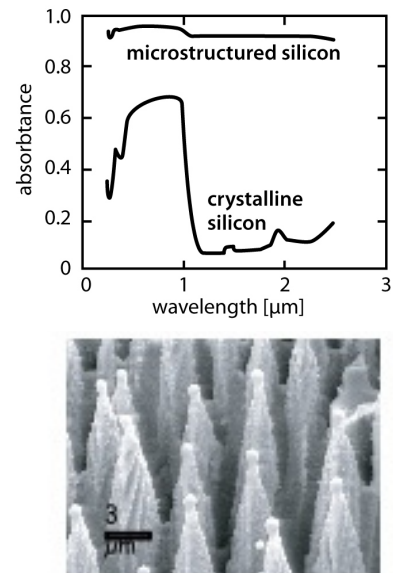

Figure 54 Silicon exposed to a plasma generated by a femtosecond pulse to produce “ultrablack” silicon. E. Mazur (Harvard University). For the above, see also B.R. Tull, M.A. Sheehy, C.M. Friend, and E. Mazur, “Chalcogen doping of silicon via intense femtosecond-laser irradiation,” *Mater. Sci. Eng., B* **137**, 289 (2007).

wavelengths in the infrared (where pure silicon is transparent). Such surfaces have promise for applications as photovoltaic devices.

The proper shaping of laser exposure also provides the opportunity for controlled annealing and freezing in microstructures and the repair of materials that have been damaged by prior irradiation. The electronic states of an atom can be excited by a laser pulse on the attosecond time scale (10^{-18} s, the time required for light to cross the diameter of an atom). It is becoming possible to design and create a light pulse that will allow specific reactions or phase transitions to occur by controlling the position and orientation of specific molecules (Figure 55, left). New sources are needed to initiate and monitor these reactions and to develop protocols for tuning these transformations.

Higher fluxes of photons and currents can be used to drive materials into new states (Figure 55). Shock compression increases pressure and temperature, but with new techniques, the drives can be shaped to tune the strain rate, from a region of near shockless loading (isentropic compression) to extremely high strain rates, generating gigabar pressures and kilo-electron-volt temperatures. These classes of experiments on large laser platforms are important for inertial confinement fusion (ICF). Ultrahigh-resolution X-ray images of dynamic compression are needed to probe this poorly understood regime, which is crucial for predicting the higher pressure-temperature (P-T) behavior of fusion plasmas.

At high pressures, the alkali metals take on characteristics of transition metals and form unusual alloys because of the changes in distribution and dispersion of electronic energy levels. Indeed, new chemical behavior is observed in otherwise incompatible elements, which combine to form new alloys and compounds. Furthermore, compression is often associated with unexpected properties, such as superconductivity that persists to high temperatures: the highest-temperature superconductivity in compounds [$\text{HgBa}_2\text{Ca}_2\text{Cu}_3\text{O}_{8+x}$ at 166 K; Figure 56] and in elements [Ca at 25 K] emerges under pressure. The application of pressure in simple oxides gives rise to entirely new classes of ferroelectrics with colossal dielectric properties that have the potential to capture and transmit energy. New super-hard materials have been made, including osmium boride, cubic carbon-boron nitride, and doped diamond. Amorphous metals, including bulk metallic glasses, that offer high hardness and super-elastic responses important for next-generation coatings, vibrational damping, strength reinforcement, and hydrogen storage are being produced under thermomechanical extreme conditions. High P-T studies test ways to enhance numerous technologically useful properties.

High electric and magnetic fields offer opportunities to control the synthesis and properties of new materials. Beyond changing the polarization state for storing information or executing digital logic, electric fields have strong effects on biomolecular materials, which are used for signaling, for controlling ion transport across membranes, and for controlling electrochemical reactions. The electric fields change electro-optic materials from transparent and opaque by rotating the polarization of light. There can be large changes in other material properties: a 30-T magnetic field shifts transformation temperatures on the order of 100 K (nominally 3 K/T) and increases the solute solubility of Fe-C alloys. Similarly, an increase on the order of 30% in Ni solubility has been

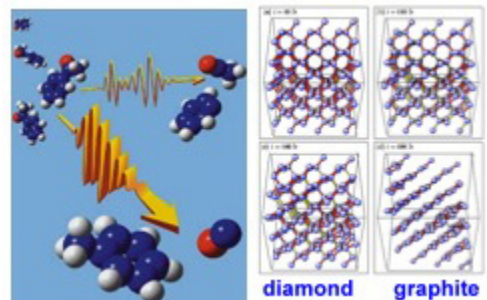

Figure 55 The frequency, amplitude, and polarization of intense light can be used to control the pathway and product distribution of photodissociation reactions of complex molecules (left) and drive phase transformations, such as diamond to graphite (right).

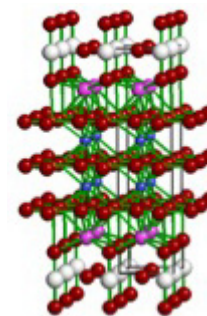

Figure 56 Structure of the highest temperature superconductor. $T_c = 166\text{K}$; $\text{HgBa}_2\text{Ca}_2\text{Cu}_3\text{O}_{8+x}$ at 30 GPa.

demonstrated for Fe-Ni alloys. This material state can be maintained in a metastable fashion after the field is removed. Processing in high electromagnetic fields represents an unexplored methodology for synthesis of new materials with tailored functionality.

In summary, the high fluxes of photons offered by next-generation light sources will provide unique capabilities for understanding how extreme environments interact with materials at the atomic and molecular levels. This knowledge is critically important to discovering revolutionary new materials with vastly improved performance that will be required for next-generation energy technologies and a wide range of other applications. In addition, this knowledge will also open the door to employing extreme environments as a unique means of creating non-equilibrium states of matter and tailoring novel materials with new properties that can perform in extreme environments.

Controlling Matter at the Nanoscale: from Nanoclusters to Nanopatterning for Nanofabrication and Nanolithography

Nanoscience and nanotechnology have the potential to transform our way of life in a manner analogous to the transformation enabled by the microelectronics revolution. In order for that to happen, however, we must be able to reproducibly produce materials and devices at the nanoscale. Next-generation light sources have the potential to provide unparalleled capabilities for characterizing nanoscale clusters of atoms as they are produced and to pattern them with nanometer-scale resolution over macroscopic areas.

Next-generation light sources are critical for advancing the frontier of nanofabrication and nanopatterning. In addition to requiring a coherent source of extreme ultraviolet and soft X-ray radiation, a very narrow bandpass is needed to exploit the potential of diffractive optics to pattern fine features. A high degree of coherence, much larger than is available with existing sources, is essential to produce high-resolution nanometer patterns. Another challenge will be to design optical systems that can tolerate high power density while maintaining beam coherence. The use of high-quality diffractive optics will allow areas as large as several square centimeters to be patterned. This will enable fabrication of large-area nanostructured substrates to be used to direct self-assembly, enable studies of site-specific chemistry, and create “smart substrates” for DNA origami and scaffolds.

While holographic imaging had been explored previously, this approach to the formation of arbitrary two-dimensional patterns was first demonstrated in the extreme ultraviolet at 13.4 nm in 2006 (Figure 57). A very high degree of coherence is needed to form an accurate pattern over a reasonable depth of focus.

One potential application of these new capabilities is the fabrication of novel diffractive optics. Today, most diffractive optics are fabricated using electron-beam lithography. While this is generally very powerful, there are issues with long-range coherence of the diffractive optics, caused by piecing together small regions written by e-beam lithography. Extreme ultraviolet interference lithography and holographic lithography could create high-resolution zone plates, gratings, and other more complex optics. Indeed, it should be possible to create a hologram of a desired pattern from a mask of the pattern itself, and then use the hologram for mass replication. This approach would be particularly appealing at wavelengths around 1 nm, more suited to phase-contrast optics.

Another potential application is the production of substrates for guided self-assembly. Nanoscale features with well-defined dimensions and tight tolerances over large areas are necessary for nanoscale materials manufacturing and for research at the interface of nanotechnology and biology. The ability to achieve the required 1–100-nm resolution and multiple square-centimeter area would be a differentiating capability that would dramatically accelerate self-assembly and nanoscale integration. For an example of guided self-assembly, see Figure 58.

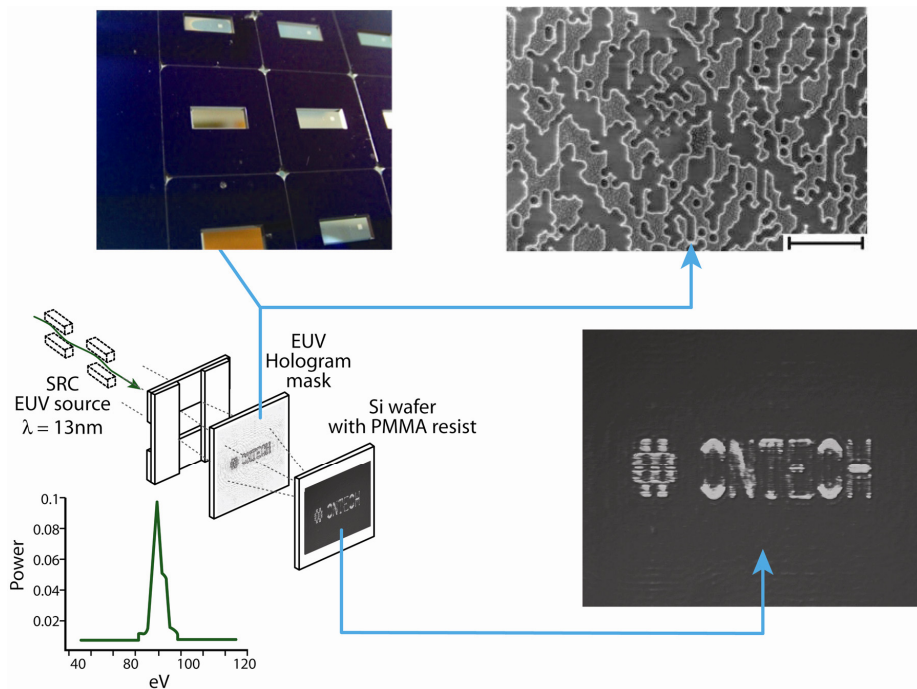

Figure 57 Holographic lithography. A computer-generated hologram (CGH) is used in an in-line Gabor hologram setup to expose the resist at the wafer. The “CNTech” logo was printed at 13.4 nm. Y.C. Cheng et al., *Appl Phys Lett* **90**, 0231116 (2007) and F. Cerrina, University of Wisconsin-Madison.

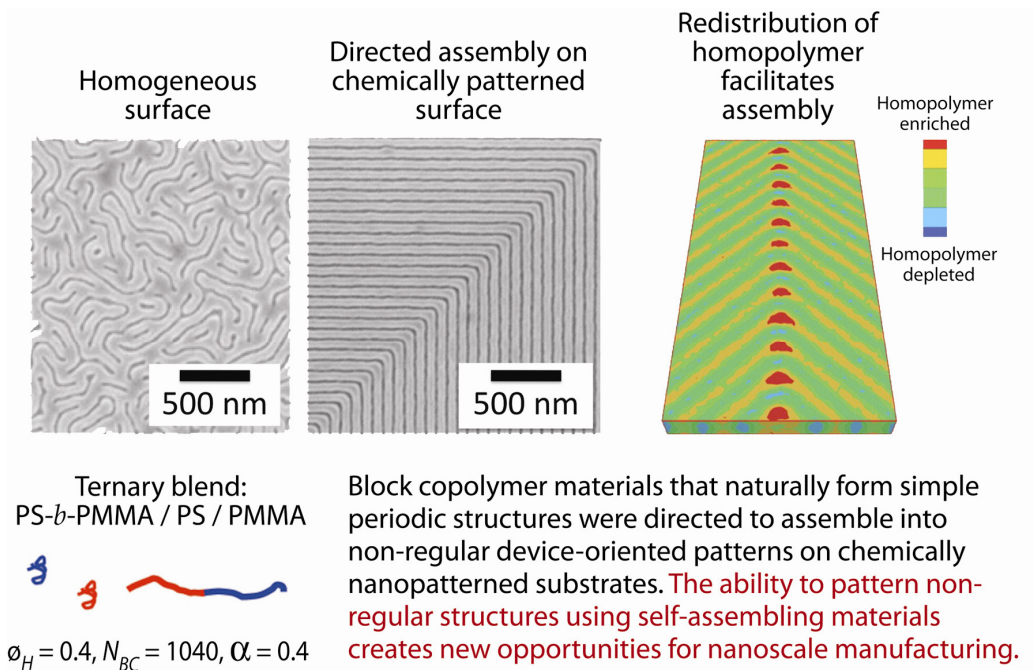

Figure 58 Directed assembly of ternary blend PS-b-PMMA/PS/PMMA block copolymers on unpatterned substrates. Block copolymer materials that naturally form simple periodic structures were directed to assemble into non-regular device oriented patterns on chemically nonpatterned substrates. The ability to pattern non-regular structures using self-assembling materials creates new opportunities for nanoscale manufacturing. (M. Stoykovich et al., University of Wisconsin-Madison)

Such a capability will enable a diverse range of investigations, including novel electronic devices, guided self-assembly, studies of site-specific chemistry, and protein binding at regularly spaced sites. The electron beam writer capabilities at the Nanoscale Science Research Centers (NSRCs) are oversubscribed; X-ray patterning of substrates will provide complementary capability for parallel patterning of large areas.

Atomic clusters represent an intermediate state of matter between individual atoms and bulk matter, where physical and chemical properties change dramatically with size. Size-selected clusters provide nanoscale laboratories for the microscopic understanding of bulk matter and for the elucidation of new phenomena emerging at small sizes. The atomic structure is the most fundamental property of size-selected clusters, but there are currently no experimental methods for direct structural determination of a cluster. Direct structural determination and manipulation of size-selected clusters constitute major scientific grand challenges in nanoscience. Direct structural determination is essential if we are to learn how to control and manipulate these structures and their electronic, magnetic, optical, and catalytic properties. Understanding the structures of size-selected clusters may lead to new pathways for the synthesis of materials with enhanced stability and strength and with tailored optical and magnetic properties.

Size-selected clusters provide the best-defined models for heterogeneous catalysts. Detailed atomic structures of both bare and chemisorbed clusters will provide the ultimate in atomic-level information about catalytic mechanisms, including the effects of cluster size, active sites, and substrates, allowing rational design of new catalysts with selected properties. In particular, new catalysts are needed for water splitting and fuel cell applications.

EXAFS can be used to directly probe the structures of size-selected clusters in an ion trap (Figure 59). The number of size-selected cluster ions in the trap can range from 10⁴ to 10⁶, which is too small to allow direct EXAFS experiments with current light sources. Good signal-to-noise EXAFS data should be obtainable with the high photon flux of the next-generation photon sources (10¹⁶ to 10¹⁸ ph/s). The most exciting prospect would be to use a single intense X-ray pulse to scatter from a single size-selected cluster to yield its entire three-dimensional structure.

Intense light sources could also be employed to obtain additional real-time information on size-selected clusters. For example, X-ray photoelectron spectroscopy could be used to investigate the local electronic structure of aqueous solute molecules. Excitation into charge-transfer-to-solvent states in water captures the stabilization of excited electrons by water dipole moments, electron detachment into the solution conduction band, or ultrafast internal conversion. With time-resolved resonant X-ray photoelectron spectroscopy using femtosecond optical and X-ray pulses, we follow these processes, including the complex solvation shell rearrangements, by observing the chemical shifts in real time.

The principal challenge will be the generation and manipulation of sub-femtosecond pulses of 100-to-10,000-eV photons. These will be primarily multi-pulse measurements, so controlling, or measuring, the relative arrival times of the pulses to a resolution better than the pulse durations will be critical. The utilization of these pulses would also benefit from developments in X-ray optics for beam splitting, recombining, focusing, and (ideally) phase manipulation. These attributes appear to be best achieved with free electron sources—in particular, a soft X-ray laser.

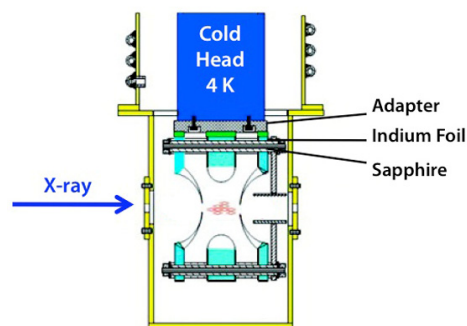

Figure 59 Temperature-controlled ion trap for EXAFS of size-selected clusters. [X.B. Wang and L.S. Wang, *Rev. Sci. Instrum.* **79**, 073108 (2008)].

A-2.2 PROBING CHEMISTRY AND PHYSICS AT THE ATOMIC AND MOLECULAR LEVELS

Many of the phenomena that occur in energy conversion, biology, environmental science, and other applications require the ability to study chemical and physical changes at the atomic and molecular levels. Next-generation light sources have the potential to enable broad new capabilities for understanding and controlling chemical and physical change in many important applications.

Catalysis and Chemical Transformations at Interfaces

The design and efficient control of catalytic energy conversion processes requires understanding the combination of each elementary reaction step, both its mechanism and dynamics, with in situ structure determination of complex catalytic materials at the atomic level. Future photon sources can offer the capability to obtain a complete picture and enable a rational design of chemical transformations.

Catalysis—the essential technology for accelerating and directing chemical transformation—is the key to realizing sustainable, economical processes for the conversion of new non-fossil feedstocks, such as biomass, carbon dioxide, and water, into fuel. Fundamental understanding of catalysts and how they function is the foundation for design and preparation of new and improved catalysts needed to produce alternative fuels like hydrogen from splitting water, alcohols from biomass, and hydrocarbons from recycled carbon dioxide. Such understanding can be achieved only by investigation of catalysts *in situ* under realistic reaction conditions. This challenge is magnified by the intrinsic complexity of catalyst surfaces and the mechanisms of catalytic transformations occurring on them.

The electronic and geometric structures of catalytic materials, inorganic or biological, under reaction conditions determine their efficiency, selectivity, and lifetime (see Figure 60). Experimental tools are currently inadequate for interrogating these features of the catalyst and their associated short- and long-lived reaction intermediates under reaction conditions. It is absolutely necessary to observe the temporal evolution of catalyst structure at temperatures, pressures, and reactant concentrations similar to those used in industrial practice. Preliminary measurements of this type clearly show that catalyst structure and morphology typically change over time under reaction conditions. Because the atomic and electronic structures of catalysts are inextricably linked, both are central to controlling catalytic efficiency and selectivity.

Knowledge of the reaction mechanism—the sequence of elementary steps by which reactants are converted to products—is central to understanding catalyzed reactions. The atomic positions, energies, and electronic structure of the reactants in their initial state, the products in their final state, and activated complexes in their transition state must be characterized for each elementary step. Furthermore, the dynamics characterizing the inter-conversion of these states must be addressed. More important for the design of improved catalysts is an understanding of how the energies and the dynamics for each such step depend

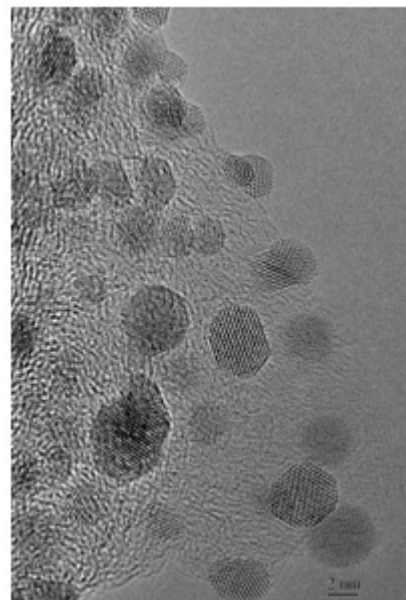

Figure 60 Structural complexity of a heterogeneous catalyst: the system Au-Pd/CNT is used for selective liquid-phase oxidation of poly alcohols. Inspection of the HR-TEM shows the large variations in local structure that presently cannot be assessed in their functional consequences, as we have no local probes at this level of resolution (from Wang Di and Robert Schlögl, FHI Berlin).

on the details of the dynamic structure of the active site and its surroundings, including the effects of reaction media.

The dynamic nature of catalysts arises from a strong coupling of the catalyst chemistry to the reactant chemistry under conditions of high conversion. Such practically relevant situations far from chemical equilibrium make it mandatory to study catalysts in exactly the environment of reactants that are used in practical conditions. This is a prerequisite for controlled process optimization, and it will allow the *ab initio* design of active materials for energy catalysis.

Scientific impact of new photon sources. Ultrafast state-specific measurements on important catalytic reactions under realistic *in situ* conditions made possible by fourth-generation photon sources will enable a new era in catalysis science. Our present approach to catalysis design lacks information on system dynamics, both on the elementary step level and on the material level. We replace this essential information with empirical concepts for making materials metastable by chemical substitution, and with nanostructuring, without a reliable concept of the desired active structure. The absence of catalytic studies under actual conditions and the lack of any reliable mechanistic information about reactive elementary steps make it impossible to address the dynamic nature of catalysts.

Catalysis is a multi-scale phenomenon with a strong coupling between the domains of space and time. With the availability of new photon sources, it will be possible to probe all relevant dimensions of chemical reactions consistently, allowing the development of catalytic materials and process conditions designed specifically for a given reaction. The new photon sources will, however, not be useful without the close collaboration of photon sciences with theory and computation, and with synthetic chemistry and chemical engineering. Only the concerted effort of all these disciplines will enable us to address a challenge of such complexity—a complete description of a catalytic reaction.

Reaction mechanisms. Two of the five grand challenges for the 21st century are (1) to control materials processes at the level of electrons and (2) to characterize and control matter away from equilibrium. Fundamental chemical events, such as electron transfer, bond breaking and formation, and internal isomerization, are intrinsically non-equilibrium processes driven by external energy flows, such as light, heat, electric fields, and pressure. Although a chemical reaction can take a long time to complete in a reactor with an ensemble of molecules, the fundamental chemical events take place on a femtosecond time scale. Capabilities of imaging fundamental chemical events, as well as controlling a chemical reaction path, will open a new era where one can rationally select external driving forces with precise amplitude and timing to achieve desirable products. These capabilities are important in energy conversions involving water splitting, CO₂ reduction, solar fuel production, and photochemical reactions in general. Current pulsed X-ray sources allow imaging of molecules on a 100-ps time scale, which is at least three to four orders of magnitude slower than the fundamental chemical events. Shortening the X-ray pulse duration into the 10-fs regime will open a new frontier in chemical sciences, enabling a chemical reaction to be imaged in real time.

Knowledge of the sequence of elementary steps by which reactants are converted into products is central to understanding catalyzed reactions. The atomic structure, energies, and electronic structure of the initial state, final state, and transition states must be characterized for each elementary step. Moreover, the dynamics characterizing their inter-conversion must be addressed—how the energies for each step depend on the details of the dynamic structure of the active site of the catalyst and its surroundings. Characterization of catalysts in the presence of reacting mixtures at the temperatures and pressures of practical operation is critical because catalyst structures and the mechanisms of catalytic reactions depend on the reaction environment. Achieving this depth of understanding will require temporal measurements

on time scales ranging from 10^{-18} to 10^4 s, if we are to describe the changes in electronic and atomic structure within single molecules and surface species involved in individual elementary chemical steps.

The Born-Oppenheimer approximation, that nuclear motion is much slower than electronic motion, has been used to interpret most chemical processes. However, this approximation may break down in chemical reactions where electron transfer is coupled to nuclear rearrangement. New light sources with femtosecond time resolution and combined spectroscopic and scattering capability will enable us to probe correlations between electronic and nuclear motion. This will, in turn, enable control of either electronic or nuclear movement via chemical modifications of the molecules to achieve a desirable outcome.

The ultimate goal for making “molecular movies” is to learn how to drive a chemical reaction down a desirable path. Current coherent control studies modulate laser pulses to drive reactions, but virtually no structural information is available in these studies. By using femtosecond X-ray spectroscopy combined with wide-angle scattering, structural information about reaction intermediates during coherent control processes can be obtained, mapping out reaction potential hypersurfaces and identifying key reaction coordinates that are most relevant in driving reactants to products along specific pathways.

Catalysis. Nature uses many systems and mechanisms to perform catalytic reactions under ambient conditions with extraordinary efficiency, speed, and complexity. The activation of nitrogen to ammonia is not only vital to the existence of life, but it is also the largest volume catalytic reaction used by humans. The synthetic process has been highly optimized through enormous scientific effort over a century’s time. The combination of ammonia synthesis with ammonia splitting would result in an energy storage cycle as effective as the hydrocarbon cycle, but with the greater advantage of being greenhouse-gas neutral under normal operation. To make such an energy cycle realistic, a catalyst for efficiently and selectively splitting ammonia needs to be developed.

Nitrogenase enzymes are responsible for the fixation of inert nitrogen through sequential molecular hydrogenation into forms used to sustain life on earth at room temperature and pressure. In contrast, the industrial Haber-Bosch process for ammonia production requires temperatures of 400-500 °C and pressures of 100 atmospheres. For most nitrogenases, the fixation occurs at the FeMo-cofactor (FeMo-co) active site (Figure 61). Fe- and V-containing clusters are also used, but they exhibit lower activity. The trapping of FeMo-co with bound nitrogen during a reaction cycle is complicated by a requirement for protons. FeMo protein must be reduced for substrate binding, but in the presence of excess protons, FeMo is oxidized back to an inactive resting form. The only small-molecule model complexes that are known to convert N_2 to ammonia are Mo-containing mononuclear complexes, and similar chemistry has yet to be demonstrated with Fe complexes. Efforts to characterize intermediates in the reaction cycle have utilized freeze quenching or chemical quenching methods, but these have suffered from the low concentrations and many possible states that are in equilibrium. Although the rate of nitrogenase catalysis is slow (millisecond time scales), nitrogenase activity is inhibited at high concentrations. X-rays have been very valuable in characterizing nitrogenases, but only in frozen static states.

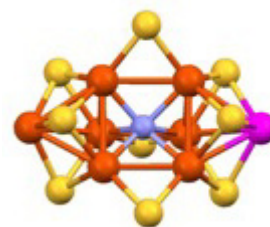

Figure 61 The Fe_6Mo -co active site of nitrogenase.

The overall mechanism for ammonia synthesis from basic elements is well known, with activation of di-nitrogen being the rate-determining step. Theory has provided us with a sequence of likely events (Figure 62), but the critical elementary step of di-nitrogen bond-breaking has never been examined experimentally. Verifying theoretical predictions would make clear which sites are relevant on a

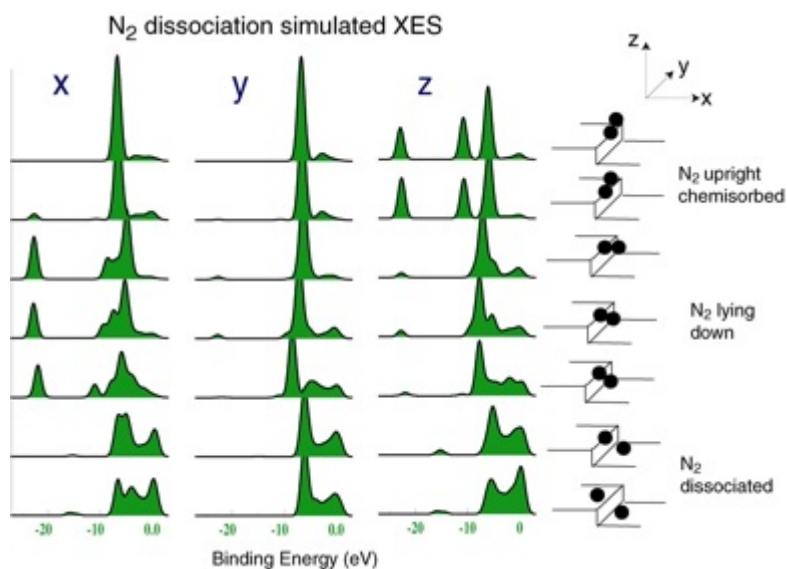

Figure 62 Theoretical prediction of the elementary step of di-nitrogen activation in technical ammonia synthesis. Experimental verification is challenging, as extreme demands on time and spatial resolution are required (from A. Nilsson and H. Ogasawara, SLAC).

heterogeneous catalyst for nitrogen activation. This would inspire a new search for active catalysts based not on optimization of the overall electronic structure, as has been done extensively in the past, but on optimizing the local geometry and the abundance of such sites on a catalyst.

Another important natural reaction for energy conversion is light-induced oxidation of water to O_2 during photosynthesis by green plants and cyanobacteria. Natural oxidation of water occurs at a rate of almost 1000 molecules/sec, three orders of magnitude faster than we can accomplish in the laboratory. Key to the understanding of both natural and artificial photosynthetic systems for water splitting, the reduction of H^+ to H_2 , and CO_2 reduction requires the ability to probe the molecular structure at atomic resolution and to follow the valence charge distribution and oxidation states under ambient conditions and on their natural time scales, ranging from femtoseconds (characteristic of energy transfer and charge separation), to ~ 100 fs (characteristic of molecular vibrations and bond formation and breaking), to picoseconds (characteristic of molecular conformational changes and diffusive processes), to micro- to milliseconds (characteristic of reactions in complex biocatalysts). In addition to the need for time-resolved crystallography and X-ray spectroscopy studies, proposed multi-dimensional X-ray spectroscopy techniques may have a tremendous scientific impact by enabling us to follow both the coherent and incoherent flow of valence charges between different active metal sites in catalytic complexes. All of these studies are beyond the capability of present-day X-ray sources.

Chemically reactive environments. In addition to catalysis, chemically reactive extreme environments are found in advanced power systems, such as fuel cells, nuclear reactors, and batteries. Creating protective surface layers that can withstand such corrosive conditions is a cross-cutting challenge for such reactive environments. The development of more robust surface layers is essential for the discovery of new forms of chemical behavior, unique synthesis approaches, and materials with such superior properties as ultra-hardness, high corrosion resistance, and high strength. Next-generation energy systems will require materials that perform reliably under harsh aqueous and non-aqueous liquid and gas

environments, as well as other potentially corrosive conditions. One of the principal challenges of creating protective surface layers is to understand the underlying mechanisms of corrosion.

Imaging techniques that will “watch” the local motion of individual atoms, as well as the motion of larger aggregates of atoms (such as dislocations and grain boundaries), are needed to understand and optimize mechanical properties. X-ray techniques can be very powerful in the examination of passive film formation, modification, and dissolution. For these problems, advances in photon scattering need to be paired with accurate theoretical calculations. An example is 3-D X-ray imaging of ion sorption sites, which demonstrates the power of multi-modal measurement techniques (Figure 63) combining two or more analytical tools to enable examination of the material surface and the direct examination of transition states and reaction kinetics. Such capabilities could permit femtosecond imaging of chemical reactions on material interfaces while simultaneously conducting three-dimensional tomographic studies of the interface (Figure 63).

Implementation challenges. Studying catalysis and chemical processes in general requires the collocation of chemical laboratories at light sources so that the required chemistry can be performed as the experiment takes place. This is quite different from the current practice at photon sources, where the preparation laboratories are physically removed from the experimental end stations. Ideally, the necessary preparation laboratory would be adjacent to the beamline, complete with furnaces, fume hoods, dry boxes, analytical instrumentation, and safety equipment associated with a typical chemical laboratory. The laboratory would also include complementary characterization tools to ensure that the sample is prepared correctly and pre-characterized immediately before the photon experiment. At the experimental end station, infrastructure would be provided to allow the on-line analysis of catalytic reaction products and the capability of multi-modal, time-resolved *in situ* characterization by, for example, Raman, ultraviolet, visible, and infrared Fourier transform.

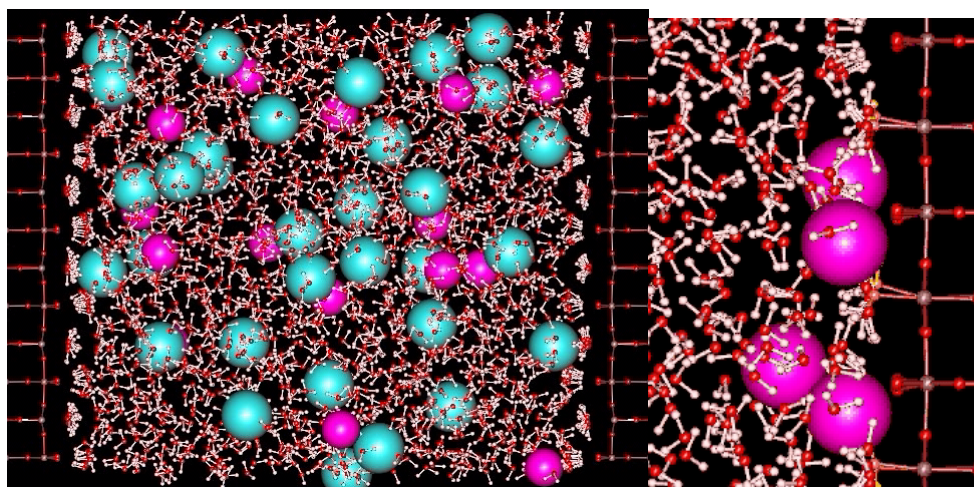

Figure 63 Theoretical model of the bulk crystal and interfacial solution structure of aqueous solutions in contact with the rutile (110) surface. *Left:* 2M SrCl₂ solution in contact with uncharged rutile 110 surfaces. *Right:* SrCl₂ solution at negatively-charged rutile 110 surface. **Color code for atoms:** Sr²⁺, Cl⁻, O²⁻, Ti⁴⁺, (white, yellow) – H⁺. [From M. Predota, Z. Zhang, P. Fenter, D. J. Wesolowski, and P. T. Cummings, “Electric double layer at the rutile (110) surface. 2. adsorption of ions from molecular dynamics and X-ray experiments,” *J. Phys. Chem B.*, **108**, 12061 (2004)].

In order to get maximum scientific benefit from these challenging experiments, it is essential that maximum information is extracted from every photon. This requires advances in theory and computation, plus advanced detector development and automation. Advanced detector development must be an integral aspect of the implementation strategy, and sufficient resources must be allocated specifically to this during the development of next-generation photon sources. It is intriguing to envision a smart detector, or series of detectors, that would allow full spatial and energy resolution of each scattered photon, for example. These detectors would allow photon correlation studies to be performed.

The complexity of these experiments will likely require a problem-oriented collaborative model for successful implementation. The Energy Frontier Research Centers could be such a model for many chemistry- and catalysis-related research projects. Teams of researchers could work cooperatively, both to maximize the probability of success of each high-risk/high-reward experiment and to coordinate and implement several different research problems that could be conducted in a given experimental arrangement. The center could encourage collaboration with theorists, both to aid in the interpretation of data and to provide feedback for the next series of experiments.

The Energy Science of Photons and Electrons

Experiments that probe and manipulate electronic dynamics on the time scale of attoseconds are critical to developing future energy technologies. Such capabilities will revolutionize our understanding of the correlated motion of electrons and how it generates the properties of molecules and their chemistry. These experiments must be accompanied with additional capabilities that probe, sometimes simultaneously, chemical and atomic motion on a time scale of tens to hundreds of femtoseconds. Time resolution, on multiple time scales, is the central quality of the capabilities required of next-generation photon sources required to meet this challenge.

Solar photons are pure electromagnetic energy, supplied to the Earth at a rate that exceeds total world energy usage by a factor of over 9,000 (*Basic Research Needs for Solar Energy Utilization*, BESAC report, 2005 [2]). When it comes to the Sun, the problem is not one of energy supply, but rather energy conversion. Converting solar energy efficiently and cheaply poses challenges at the frontiers of science, engineering, commerce, economics, and politics. This section addresses one of these challenges: to understand the initial conversion of light from the Sun into other practical forms of energy. This front-end science is where much of the potential for solar energy is lost, and where much of the potential economic gain might be found.

Physics tells us much about this initial step in energy conversion. We know, for example, that light from the Sun is parceled into photons with a mean energy of about two electronvolts (i.e., roughly the work that can be delivered by one electron from an ordinary battery). We also know from physics that electrons are the principal means of transforming this light energy into work—practically speaking, our *only* means of accessing solar energy. The fundamental physics of light interacting with electrons falls within the subfield of AMO (atomic, molecular, and optical) physics, which has established a vocabulary to describe what happens: light interacts directly with the electrons in molecules to promote them to excited states, where they generate altered interatomic forces that initiate chemical changes or generate electrical power through charge migration. Thus, electrons are the transformers of light into other forms of energy.

The instant a solar photon is absorbed by an electron, the molecule has an additional energy equal to the photon's energy. But only a fraction of this energy can be stored or used before dissipation sets in, typically in far less than a picosecond. Therefore, efficiency requires that nature be ultrafast, and probing the intermediate steps in this process must be hundreds of times faster.

The transfer of charge represents the key step in molecular electronics, photovoltaics, and electrochemistry. Photochemical systems can directly split water to produce hydrogen and oxygen as chemical fuels. Understanding and controlling photoprocesses that produce electrical or chemical energy will lead to more effective light harvesting for energy applications and more efficient catalytic production of chemical energy.

Electrons are nature's energy transformers, not only in photochemistry and photobiology, but also in catalysis, combustion, electricity storage in batteries and supercapacitors, and electric power generation. The valence electrons dictate the chemical reactivity of materials and catalysts. Efficient chemical activation requires catalysts with a high density of easily accessible excited electronic states that can be used to shuttle electrons to and from the substrate. Observing, understanding, and controlling the dynamics of these valence electrons has the potential to transform our understanding and control of chemical reactivity.

The ability to experimentally observe the dynamics of electrons on their natural length and time scales via powerful attosecond and femtosecond pulses in the ultraviolet and X-ray range will reveal how correlated electronic motion determines the properties of atoms, molecules, clusters, and matter in general. These dynamics underlie nearly all photochemical and photomaterial processes through electronic correlation and energy exchange in systems driven temporarily far from equilibrium. These have all been designated grand challenges in energy science by BESAC.

There are three primary challenges in understanding and controlling the efficient conversion of photoenergy to electrical and chemical energy.

1. *Electron-electron correlation.* Electrons correlate their motions through their mutual Coulomb repulsion and by a uniquely quantum-mechanical effect known as Fermi exclusion (two electrons cannot occupy the same state at the same time). This Coulomb and quantum-mechanical correlation among electrons is responsible not only for their endless diversity of stable structures, but also for the rich dynamic behavior that controls their functionality (for example, in superconductivity or photosynthesis). Next-generation light sources will enable new approaches to observing and understanding this fundamental electron-electron correlation.

2. *Electron-ion correlation.* Electrons move on the time scale of a few hundreds of attoseconds, whereas atoms and ions move on the femtosecond time scale. This separation of time scales allows fast electrons to respond nearly instantaneously to slow atoms and ions, a basic principle known as the Born-Oppenheimer approximation. At the moment of bond formation, however, the electrons change their orbital configuration as the atoms or ions change their spatial configuration, and the Born-Oppenheimer approximation breaks down. Understanding the strong electron-ion correlation and the breakdown of the Born-Oppenheimer approximation during chemical reactions is key to learning to control the conversion of photons to electricity and chemical fuel.

3. *The path from understanding to control.* In chemical physics, function and form are intimately related: the structure of a molecule or molecular assembly governs its function. This connection between function and form is the reason that X-ray crystallography of biomolecules has led to such enormous progress in biology and medicine, and we expect no less in energy science. The molecules and molecular assemblies that carry out energy conversion are complex, and we are just beginning to probe their dynamic functions at the molecular level. There are at least two grand challenge stumbling blocks in controlling energy conversion in complex molecules. First, we have only crude design rules that tell us what structures will lead to particular desired functions. Second, we have very limited abilities to produce arbitrary structures, other than the ones we happen to find in nature.

Addressing these three challenges requires a new class of experimental tools. Outlined below are four new classes of experiments that address these grand challenges.

Attosecond manipulation and control of the correlated motion of electrons. In recent decades, femtosecond laser experiments have played an ever-increasing role in extracting key information about fundamental atomic and molecular mechanisms. Those experiments have established new frontiers in the study of chemical transition-state dynamics, cluster and liquid-state caging dynamics, and photoprocesses in photosynthetic systems and visual pigments, as well as such coherent phenomena as wave-packet dynamics and quantum information. However, the problems of correlation require measurements on the attosecond time scale. While there have been major recent breakthroughs in attosecond science, based on the technology of high harmonic generation (HHG) to produce attosecond pulses in the ultraviolet and soft X-ray regions of the spectrum, the low intensity of these laser-based attosecond sources ($\sim 10^7$ photons/sec) severely limits the types of experiments that can be performed. The same is true of the femtosecond regime for ultraviolet and X-ray pulses.

The new generation of intense, tunable ultra-short pulses of ultraviolet and soft X-ray radiation from free-electron lasers will fundamentally change this situation. The advent of sub-femtosecond pulses in the soft X-ray regime is opening up the possibility for direct study and manipulation of electronic motion on that time scale. The experiments will be dramatically more challenging than those being undertaken today, in terms of production and detection of combinations of multiple radiation pulses, and they will rely on the robust detection of signals to probe effects that are almost undetectable today. To be successful, they will require flexible, intense soft X-ray sources that provide those signals and that will allow multicolor X-ray experiments.

One class of experiments will first pump an atom or molecule into an excited state with a finite lifetime, and then probe it with a sub-femtosecond pulse during that lifetime to ionize or double-ionize the target molecule. These experiments will make use of momentum-imaging detectors of the electrons and of the ions produced by the pump and by the probe to give a complete momentum map of the final state, containing the signatures of correlation of the initially pumped metastable state and its decay. Other experiments will probe transitions between closely spaced electronic states induced by the vibrational and rotational nuclear motions. Experiments such as these will push the limits of FEL sources, since they require tunable and intense sub-femtosecond pulses, synchronization with other sources (such as lasers, high harmonic generation, or another FEL pulse), and high repetition rates.

Time resolved core-hole spectroscopy in the gas phase and in solution. X-rays naturally interact with the core electrons of atoms in molecules, which normally do not participate directly in chemistry. A new experimental protocol made possible by ultrafast X-rays could use these electrons as localized sources of excitation, and then follow that excitation as it moves out from its source throughout the molecule. The changes in transient spectra involving these electrons reveal the shape and structure of the space through which they travel. Their initial localization can be controlled by the wavelength of the X-ray laser, through atom-specific resonances. Thus, sub-nanometer localization occurs even without sub-nanometer-wavelength light.

Core-level photoelectron spectroscopy (XPS) from liquid water and aqueous solutions is a step in this direction. This has been recently demonstrated using a vacuum liquid microjet to overcome the absorption of photoelectrons by the high water vapor-pressure environment. The XPS sensitivity to local structure enables exact determination of electron binding energies of both solute and solvent water molecules. Importantly, these energies sensitively depend on detailed local hydration structure. Rearrangement of the hydration structure (e.g., upon accepting charge or upon photo-excitation) is known to play a crucial role

in chemical reactivity and biological function in aqueous environments. Distinct site-specific electron binding energies can be observed for the different carbon and nitrogen atoms in aqueous amino acids and their building blocks.

Another unique feature of XPS arises for resonant excitation of a core level, which for some solutes leads to additional peaks in the electron emission spectrum. These peaks reveal localization of the excited electron through spectator Auger-electron decay, or they originate from a unique energy transfer into neighbor water solvent molecules, as has been demonstrated for aqueous chloride and aqueous hydroxide. Ultrafast electron delocalization or energy transfers observed in this way occur on the time scale of the core-hole lifetime (around 4 fs for oxygen 1s). Understanding the exact underlying mechanisms would require analogous resonant XPS measurements from the optically excited solution. Using future light sources, such measurements might be conducted, since they require femtosecond X-ray pulses, with photon energies tunable near the respective absorption edge and synchronized with an optical femtosecond pump pulse.

In photoelectron spectroscopy (PES) measurements (Figure 64), the photon flux must be low enough not to produce space charges, which severely distort the photoelectron spectrum. Thus, PES investigations do not need the extreme peak brightness available from next-generation light sources. However, femtosecond X-ray pulses with tunable energies in the ranges of common elemental core levels are absolutely mandatory. Space-charge generation is less of an issue for techniques based on detection of X-ray photons rather than electrons. X-ray absorption spectroscopy (XAS) measurements, which likewise require synchronization of femtosecond optical and X-ray pulses with tunable photon energy, complement time-resolved XPS.

Applications go well beyond the examples given here; they include radiation damage in DNA, catalysis, atmospheric and environmental chemistry, and light-energy conversion.

Observing the breakdown of the separation of the time scales of nuclear and electronic motion. While the natural time scale of electron dynamics is of the order of a few hundred attoseconds, that of the motion of the atoms themselves during a reaction or as they vibrate in a molecule is of the order of tens to hundreds of femtoseconds. However, during chemical reactions, the motion of the electrons as they form chemical bonds matches the slower motion of the nuclei. The Grand Challenges report [1] identifies this breakdown of the Born-Oppenheimer approximation at conical intersections (shown schematically in Figure 65) as a central challenge to our understanding of photosynthesis and the photochemistry of vision, for example. The surprise is that in large molecules involved in photochemical processes like photosynthesis, there are generally many such intersections, and nature has made use of them to control the flow of energy and chemical change.

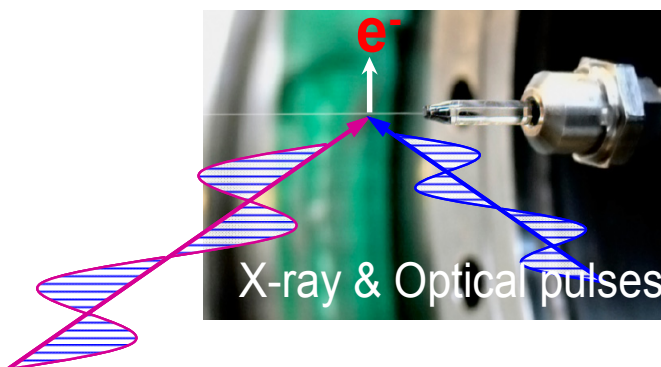

Figure 64 Vacuum liquid microjet for photoelectron spectroscopy with femtosecond optical pump and femtosecond X-ray probe pulses (from Bernd Winter (BESSY), 2008).

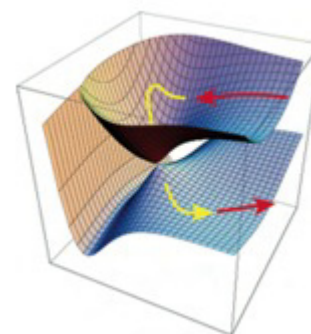

Figure 65 Conical intersection, the point of contact between the potential-energy surfaces of two different electronic states in a molecule (from the BESAC Grand Challenges report).

Soft X-ray FELs open new doors to understanding and exploiting these phenomena. In conventional femtosecond photochemistry, a vibrational wave packet is created within a single electronic excited state, and the subsequent molecular dynamics are determined by the Born-Oppenheimer potential energy surfaces on which the wave packet evolves. The advent of extreme ultraviolet and soft X-ray attosecond pulses provides a new excitation regime that cannot be described within the Born-Oppenheimer approximation. For example, a 300-as pulse has a bandwidth of 6 eV, sufficient to create a coherent superposition of multiple electronic states. As the wave packets of these states evolve and meet at conical intersections, they control the branching between electronic states in the course of the chemical reaction. Phase and amplitude shaping of the attosecond excitation pulse enables manipulation of the electronic and vibrational wave packets and their evolution. Attosecond soft X-ray probe pulses can not only probe, but also control, the molecular dynamics of chemical reactions.

Multi-temporal and multi-spectral methods. Multiple time and spectral correlations exist in almost all complex chemical processes, including photochemistry and catalysis. Finding and analyzing these correlations could lead more directly to solutions to basic energy problems. Ultrafast multi-temporal and multi-spectral techniques must be developed to illuminate the critical role of correlated chemical processes in a wide range of critical energy problems.

Energy processes depend on many correlated steps to convert or concentrate energy. Attempts to analyze the mechanisms are hampered by inaccessibly fast time scales, the lack of a time trigger (such as a laser pulse) to start the chemical conversion process, decoherence, and other factors. Multidimensional spectroscopic techniques attempt to resolve these problems by looking for correlations in the time and frequency response of pumped excitations. This approach is analogous to multidimensional NMR spectroscopy, which probes the atomic structure of small molecules, and for which the 1991 Nobel Prize in Chemistry was awarded. Over the past fifteen years, these techniques have been extended to femtosecond pulses in the infrared and the visible and applied to probe correlated vibrational motions and energy transfer processes in photosynthetic systems. Extending these techniques to attosecond X-ray pulses will offer numerous new possibilities.

In a stimulated Raman experiment, one can prepare a doorway wave packet of valence excited states in the vicinity of a selected atom and watch its evolution by probing its effect on neighboring atoms with a window wave packet. An example could be an oxygen and a nitrogen in quinolinol. The technique requires two pulses, with no phase control. The signals provide a view of the entire manifold of valence states allowed by the bandwidth of the doorway pulse. They are not subject to dipole selection rules.

More challenging four-wave mixing experiments, pictured in Figure 66, will require four coherent beams with wave vectors k_1 , k_2 , and k_3 , and phase control. The photon echo signal is generated along $-k_1+k_2+k_3$. The three time intervals can be controlled. This signal is plotted as a Fourier transform with respect to t_1 and t_3 . Its off-diagonal cross peaks between two core holes will show up only when they interact. The variation with t_2 reveals the dynamics of energy transfer. The double quantum coherence signal generated along $k_1+k_2-k_3$ is induced by electron correlations and vanishes for non-interacting electrons. It provides multidimensional images of the many electron wave functions and can be used to test the calculations of correlated many-electron wave functions.

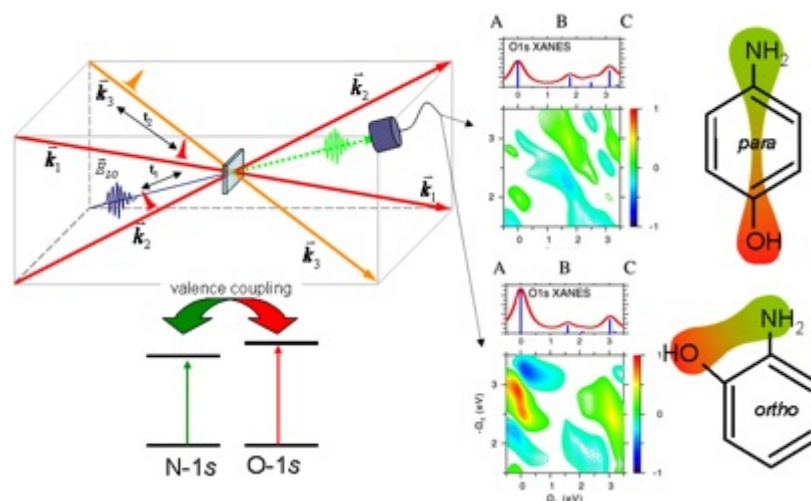

Figure 66 Left: Illustration of four-wave mixing of ultrashort X-ray pulses resonant with the O-1s and N-1s levels; Middle: Theoretically predicted two-dimensional spectra, the lower of which exhibits the coupling of excitations on the oxygen with those of the nitrogen in para- and ortho-aminophenol molecules at right. [From I.V. Schweigert and S. Mukamel, *Phys. Rev. Lett.* **99**, 163001 (2007)].

A-2.3 ENVIRONMENTAL, GEOLOGICAL, AND PLANETARY SCIENCES

Next-generation photon sources with extreme average brightness, ultrafast pulses, and a broad energy range (0.1–100 keV) are essential for extending our understanding of atomic- and molecular-scale structures and processes at mineral fluid interfaces, for nanoparticle studies, and for studies of materials under extreme conditions found in deep-Earth and planetary environments.

Environmental and Earth Sciences

Current investigations of mineral/aqueous solution interfaces using synchrotron-based surface X-ray scattering and X-ray spectroscopy methods have produced spectacular advances in our knowledge of chemical reactions at surfaces and interfaces, but they are conducted on ideal or near-ideal surfaces and highly simplified interfaces of relatively large single crystals. Generally, work with nanoparticles has been limited by brightness (Figure 67), and studies of organic solutes on solid surfaces have been restricted due to the low scattering power of the organics or their finite lifetimes in the X-ray beam. Studies of material properties at ultra-high pressure are limited by the brightness, spatial resolution, and time structure of existing light sources. Most of the research challenges require smaller focused beams, increased photon fluxes, and substantially improved detectors. Future work will need to extend interfacial studies to more realistic interfaces, such as those having several types of interacting species, including organics and microbial organisms; non-ideal surfaces with structural inhomogeneities; and mineral nanoparticles in the 2–10-nm size range. High temporal resolution constitutes a new research frontier, offering the potential to probe in detail the sequence of events (for example, ion hydration and dehydration, adsorption, and charge transfer) that constitutes chemical reaction at mineral interfaces, and to do time-resolved studies under high-pressure/high-temperature experimental conditions.

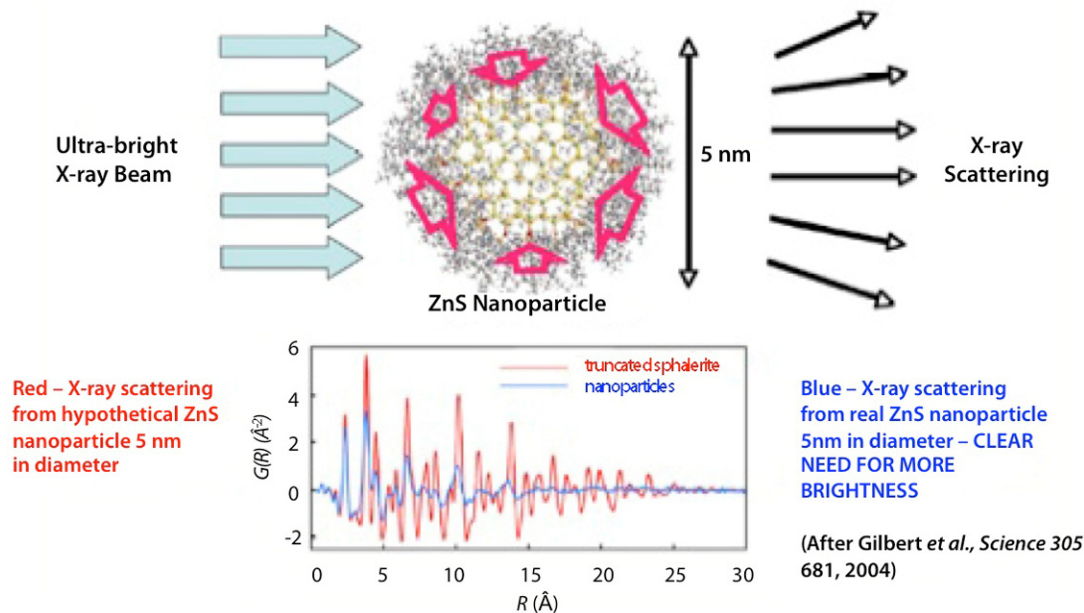

Figure 67 X-ray scattering from a hypothetical individual 5-nm ZnS nanoparticle compared with experimental scattering from a collection of 5-nm ZnS nanoparticles, showing clear need for increased brightness.

The ultimate earth science application of next-generation light sources involves understanding and predicting macroscale phenomena from knowledge of the fundamental interactions at mineral surfaces and the atomic-scale structure of materials. Important questions to be addressed include the following: What controls the reactivity of a mineral nanoparticle surface in contact with aqueous solutions or atmospheric gases? What is the structure of the mineral-fluid interface? How do ions and organic macromolecules adsorb to charged mineral-water interfaces? How do microbial organisms interact with and modify the structure and reactivity of mineral surfaces, including the transfer of electrons from microbe to mineral surface? What controls the cycling and speciation of redox-sensitive elements, such as iron, chromium, sulfur, arsenic, and selenium? What are the structures and transport properties of minerals and liquids at the extreme pressures and temperatures of planetary interiors, and how are minor and trace chemical constituents incorporated into them? Three examples are described below.

Structure and reactivity of mineral nanoparticles. The internal atomic arrangement and properties of some classes of nanoparticles, including naturally occurring ones important in the biosphere, change dramatically with decreasing size below 10 nm. For larger mineral grains, in hydrated environments the mineral surface can have structure and composition radically different from the bulk mineral. Hence, we suspect that the surfaces of nanoparticles have special properties as well, but we don't know how the surfaces of nanoparticles differ from the bulk particle. This issue is important because nanoparticles may act as natural catalysts in biological and environmental systems; perhaps their surfaces constitute the location where most natural chemical reactions occur in Earth's biosphere.

Key to understanding the reactivity of mineral nanoparticles is knowledge of the geometric and electronic structure and composition of nanoparticle surfaces. The surface properties may vary in terms of defect structure, as a function of pH and surface charge, with the composition of aqueous solutions in contact with the nanoparticle, and with temperature and pressure. The electronic structure of individual nanoparticles could be determined using X-ray photo-emission studies that employ an ultrabright soft X-ray source focused to a 5–10-nm-size X-ray beam. The need to study nanoparticles under reactive

conditions, from ambient to supercritical, requires special differentially pumped ultra-high vacuum systems.

Some key areas of energy importance, such as understanding the reactions of CO₂ sequestered in deep geologic reservoirs and the interaction of geothermal fluids with earth materials, will require studies of supercritical CO₂-H₂O fluids. The structure of solids in contact with aqueous solutions and supercritical CO₂-H₂O-brine mixtures characteristic of deep (> 800-m) geologic formations could be determined through X-ray scattering studies of individual nanoparticles by using ultrabright (10¹⁶ photons/sec-μm²-mrad-0.1% bandwidth), high-energy (50–100-keV) synchrotron beams. In addition, EXAFS studies of probe ions adsorbed on nanoparticle surfaces at low surface coverages, less than 10% of a monolayer, will yield information on reactive surface sites because of the sensitivity of EXAFS to second-neighbor distances. At present, such experiments can be carried out only on collections of nanoparticles having interface areas greater than tens of square micrometers. A next-generation ultrabright light source would make it possible to carry out such studies on individual nanoparticles in the 5–10-nm size range or on accessible surfaces of irregular or dynamically changing materials.

Electron transfer during oxidation reactions at mineral/aqueous solution interface. A serious environmental problem is created by the oxidation of pyrite exposed in mining operations, including coal mining. The process is poorly understood because of its complexity; it involves both biotic and abiotic reactions. A related problem is oxidation of pyrite in fly ash produced by the burning of coal, which produces acids via oxidation, leading to acid rain.

Study of the pyrite oxidation process is a prototype for studies of many types of environmental interfacial reactions involving electron transfer and the production of reactive chemical species. Reactions that occur on time scales of less than one millisecond are central to biogeochemical processes. For example, the cycles of redox-active elements, such as iron, chromium, sulfur, arsenic, selenium, and oxygen, are tightly coupled to the carbon cycle in both marine and terrestrial environments. Many of the pathways involve transfer of multiple electrons between aqueous ions and solids, and thus occur at hydrated mineral surfaces. However, the ultrafast time scale of the fundamental chemical steps renders them inaccessible to conventional study.

For pyrite, the oxidation process is both self-catalyzed and also coupled to bacterial metabolism, but the complete system is so poorly understood that our best concepts are close to guesswork. The oxidation process is initiated by electron removal from a pyrite surface at an Fe²⁺ center (low spin), making a high-spin Fe³⁺ center. Subsequent electron transfer moves a sulfide electron to the Fe, reestablishing the low-spin Fe²⁺ state, but oxidizing the sulfur (Figure 68). The system effectively locally resets, but the surface ligand configuration of the sulfur is altered. This is the first step of an inorganic electron transfer shuttle, and subsequent steps oxidize the surface sulfur and add water ligation, until eventually a sulfate group leaves the surface together with Fe²⁺. The process achieves oxidation of sulfide to sulfate (six electrons removed) with controlled, much lower potential steps. There is also empirical evidence that the main bacteria involved in pyrite oxidation (*Acidithiobacillus ferrooxidans* and *A. thiooxidans*) produce different reaction products, including ferrihydrite (Fe(OH)₃), goethite (α-FeOOH), schwertmannite (Fe₈O₈SO₄(OH)₆), and hematite (α-Fe₂O₃), depending on the consortium of bacterial species present (Figure 69). This picture is consistent with observations; however, although some of the shuttle reaction steps are slow enough to be imaged using a variety of now-available photon tools, all of the electron transfer steps are inaccessible. Hence, understanding this system to the level needed for kinetic control is impossible without information from ultrafast experiments.

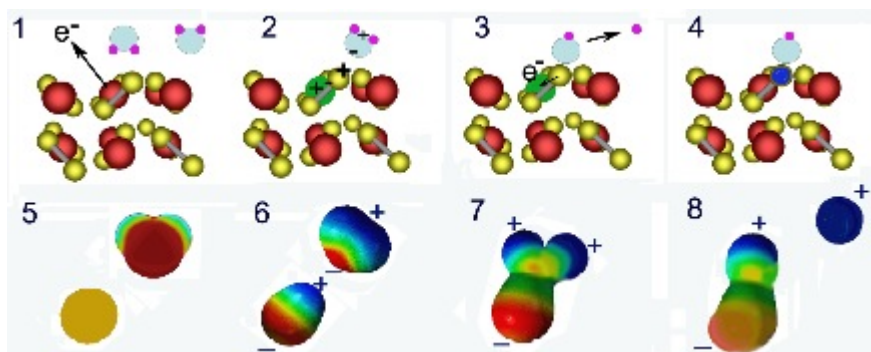

Figure 68 Fe^{3+} adsorbs to the pyrite surface and extracts an electron from a surface Fe^{2+} ion (1). This creates a rearrangement of charge and orbital configurations with an adjacent sulfide dimer group, so that the group is positively charged and subject to nucleophilic attachment by water (2). In that reaction, water is split, releasing a proton to solution and injecting an electron into the conduction band of the pyrite, with the remaining hydroxyl unit binding to the oxidized sulfide (3). The conduction band electron recombines with the ferric ion, returning it to the ferrous state. (See steps 1-4 in figure; 5-8 are orbital electron density changes.) This process can be repeated with the ferric ion acting as an “electron shuttle,” and with each succeeding step the sulfide is progressively oxidized and ligated until it forms a “leaving group” (i.e., sulfate), which enters into solution. Hence, as the pyrite dissolves, the solution gains protons and sulfate and turns into sulfuric acid. Microbes play a role; they reconvert the ferrous solution species back into Fe^{3+} , thus creating a catalytic cycle (see Figure 69). Source: Glenn A. Waychunas, LBNL.

The main difficulty in pursuing such studies is lack of sufficient time resolution and sufficient photons on the interfacial structure. Today, experiments on the pyrite/solution interface, with electrons removed by simple organic molecules attached to the surface, can be done with time resolution on the order of 100 ps. This needs to be improved at least 1000 times, and perhaps 10,000 times, to measure the details of electron transfer. At this ultrafast time resolution, scattering experiments may plot electron density maps that show the interfacial electronic redistributions. Hence, we would directly measure what we can only show today with cartoon depictions (Figure 69). In addition, pump-probe delays would be possible that allow study of the slower consequences of ultrafast interface electron transfer: molecular rearrangements, ligand exchanges, soliton motion, and many slower processes. Performing only ultrafast experiments would miss much of the rich system dynamics, including coupled energy transfers and energy dissipation, needed to understand the complete overall mechanism. A large time-resolution range is required, as well as flexibility in pulse structure and separation.

Mineral properties at high pressure. The gradual evolution of the Earth and other planets over the 4.55-billion-year lifetime of the solar system is controlled ultimately by the properties of rocks and minerals. Some of the most basic questions about the Earth, such as why there is abundant liquid water at the surface, why only a small amount of the carbon is at the surface, and how much carbon and hydrogen are in the core, are intractable in the absence of knowledge of mineral physical properties at the high pressures and temperatures of planetary interiors. We do not know, for example, the abundance of carbon in the deep Earth, nor do we know what form it is in—dissolved in minerals, in grain boundaries, in fluids, or as separate phases. A similar set of questions applies to water and hydrogen in the deep Earth. Current estimates suggest that about half of the Earth’s water is held in the mantle, whereas the mantle

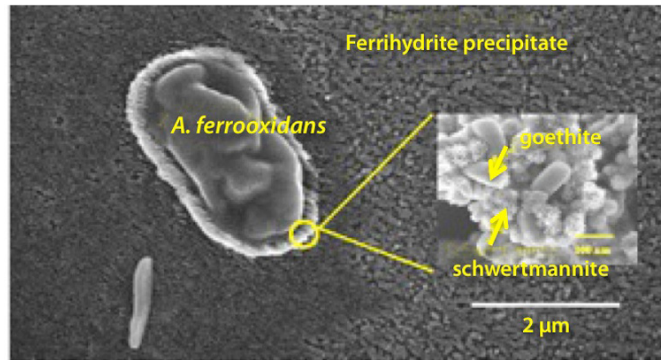

Figure 69 Scanning electron micrographs of *Acidithiobacillus ferrooxidans* on a pyrite (100) surface, showing a reaction rim consisting of a mixture of goethite and schwermannite nanocrystals, and ferrohydrite precipitate. Source: Gordon Brown, Jr., Stanford.

and core may contain more than 99.999% of the Earth's carbon. This contrast is dramatic, but even more astounding is that current models for Earth's earliest stages of evolution suggest that much of the carbon was once in the atmosphere but then somehow returned to the mantle!

Even for less extreme conditions characteristic of nearer-surface environments, there are basic unresolved questions, such as the extent of hydrocarbon synthesis and stability (i.e., abiotic carbon). We know neither the limits of life in extreme environments nor the molecular basis of those limits. The atomic basis of rock failure and the brittle-ductile transition in rocks at depth, which controls the depth of earthquakes, is not understood, nor is the nature of mantle flow. The heat sources in the mantle and core ultimately responsible for geothermal processes, and the identity of light elements (including carbon and hydrogen) in the core, are not known.

Photons remain the key probe of the crystallographic, electronic, and defect structures of geological materials. Brighter photon sources for soft and hard X-rays with 1–100-keV energy are essential for addressing the most critical scientific issues. New probes are needed to map out the distribution of carbon in complex earth materials under extreme conditions of temperature and pressure, including sources for nano-tomography, -diffraction and -spectroscopy. New nanofocusing and imaging techniques would allow imaging of complex natural mineral assemblages, textured materials, and buried interfaces under extreme conditions. Single-phase diffraction and scattering techniques need to be extended to tomographic imaging of bulk materials under extreme conditions using nanometer-scale beams. *In situ* monitoring of dislocation movement using time-resolved X-ray topographic methods could clarify the nature of deformation of rocks under pressure. Direct measurements of materials under dynamic compression, including combined static and dynamic compression techniques, hold the promise of accessing and probing entirely new pressure-temperature regimes.

Transport properties at extreme pressures: In the past decade, existing light sources have provided powerful micro-probes for studying materials properties, such as crystal structure and equations of state, at deep-Earth conditions. However, very limited experimental measurements of the transport of physical quantities at extreme conditions exist; in many areas, there are none at all. All dynamic processes, such as the geomagnetic field, plate tectonics, thermal evolution by cooling or warming, and the budget of carbon and water inside Earth, are governed by the transport of materials or energy through various parts of the Earth. Enabling experimental measurements of these dynamics requires next-generation X-ray sources. For example, 3–5 orders of magnitude higher brilliance will make feasible measurements of the viscosity

of liquid iron at conditions of the Earth's outer core, which would provide direct experimental information for modeling the outer-core dynamo. Time-resolved, nanometer-resolution mass density tomography would allow for measuring diffusion and the detailed geometry of liquid-solid interfaces, such as the dihedral angle at the condition of the core-mantle boundary, where the liquid outer-core material meets solid silicates.

Time-resolved measurements at extreme P-T conditions: One common technique for simulating the conditions of the deep Earth is to use laser-heated diamond anvil cells (Figure 70). However, with the traditional continuous-wave laser heating techniques, laser heating at megabar (greater than 100 GPa) pressures causes frequent anvil failures. Pulsed laser heating, which reduces the exposure of the cells to extreme conditions and allows high P-T conditions to be reached, requires that characterization of the materials under such extreme conditions be done by time-resolved methods. Time-resolved high-pressure studies would provide important information on structural dynamics, phase transition dynamics, and chemical reactions under high pressure, as well as information on materials' metastability.

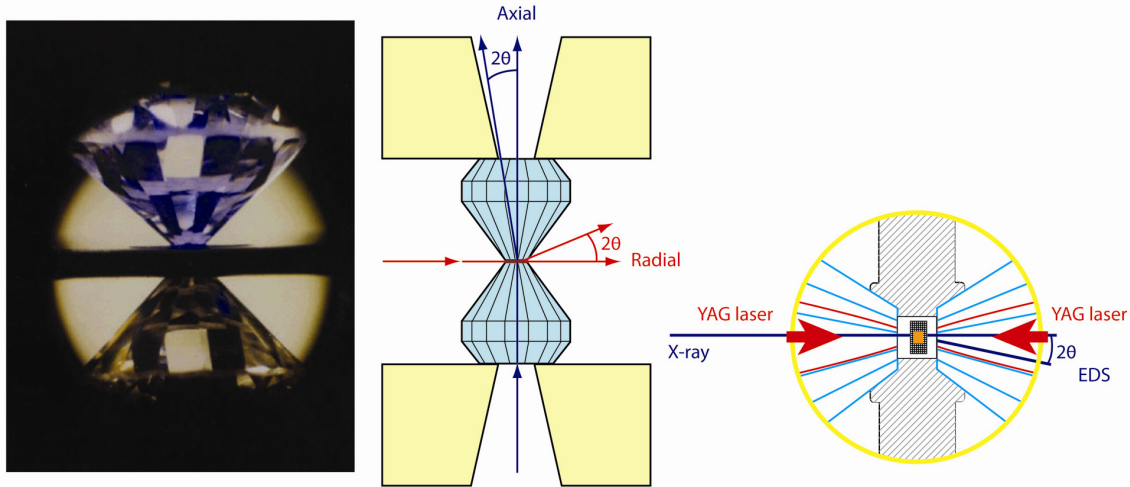

Figure 70 Configurations of diamond anvil cells for high P-T X-ray experiments on materials under extreme conditions [R.J. Hemley and N.W. Ashcroft, *The revealing role of pressure in the condensed-matter sciences*, *Physics Today*, **51**, 26-32 (1998); R.J. Hemley, to be published]

Warm dense matter and fusion plasmas. Warm dense matter and fusion plasmas are closely related to the extreme environments found in the deep Earth and other planetary environments. A detailed understanding of material properties over a very broad P-T regime is required for truly predictive capability with respect to inertial confinement fusion implosions. For example, the hydrogen fuel in a typical ignition implosion design spans from $T \sim 20$ K to 10^8 K, $P \sim 0$ to $> 10^8$ Mbar, and $\rho \sim 0.2$ g/cm³ to 1000 g/cm³. Warm dense matter (WDM) is a regime of $T \sim 10^6$ K and $\rho \sim 10$ g/cm³, which defines the boundary between condensed matter and dense plasmas (Figure 71).

The production and characterization of some of these states of WDM require next-generation light sources in combination with large, high-energy density drivers, such as laser or shock compression. For example, ultrahigh-resolution X-ray images of a sequence of strong shocks are needed to determine density profiles, thereby revealing equation-of-state (EOS) and transport information. The optical properties of this warm to hot dense matter are needed to determine opacities using broadband X-ray

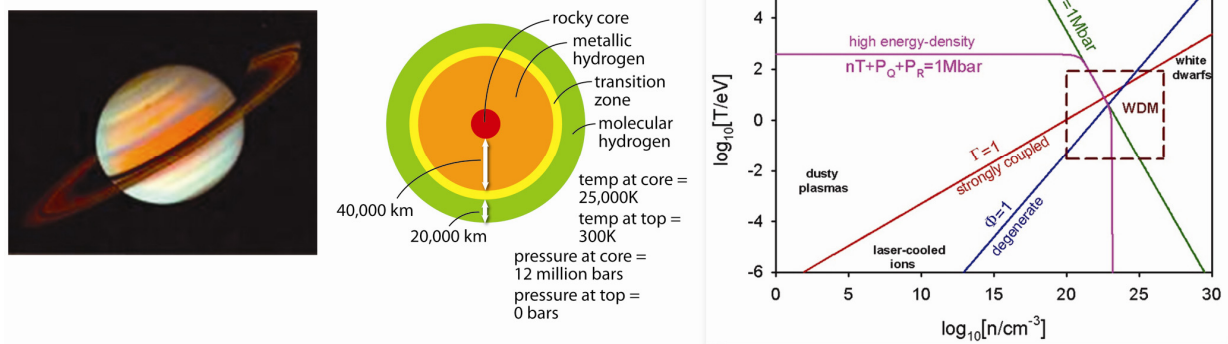

Figure 71 The WDM regime is important for understanding dense plasmas in planetary environments (e.g., Saturn, shown). The temperature-density phase diagram for hydrogen, illustrating important regimes of matter, including WDM, is shown at right in the figure. Of particular interest are lines marking the boundaries for temperatures below which the matter is strongly coupled (Coulomb energy = kT) and for temperatures below which Fermi degeneracy is important (Fermi energy = kT). [from G.W. Collins, LLNL]

sources. Compton scattering off dense fuel can give temperature and collisionality of the dense plasma in a regime where calculations are very difficult. Each of these experiments would require significantly greater capability than currently exists, in terms of both the light source and the high-energy density driver creating the dense states of matter. The latter experiment would require a narrow bandwidth with 10^{10} – 10^{13} photons per pulse every 10–100 ps, combined with a large driver.

There is no general theory and no predictive capability for WDM, because the approximations that allow the construction of theories in either condensed matter or the high-temperature, low-density plasma regimes are invalid in the WDM regime. Experimentally, WDM has not been characterized at the atomic level. *In situ* probes of all atomic and electronic interactions are required to identify the crucial physics and allow development of the necessary theory. Producing descriptive theories will provide a level of understanding of WDM that will allow its exploitation for fusion production of energy.

A-2.4 LIFE SCIENCES AND MEDICAL APPLICATIONS

The main goals of photon scattering in life and medical sciences are to understand how nature designs and builds its complex molecular machines, and how they operate and function at the molecular level. This can only be achieved by moving from a static picture to a dynamic one and by developing a complete understanding from the molecular to the cellular level. For the first time, new photon sources can offer the possibility of obtaining a complete picture of the structure and function of biomaterials.

Nanoscale Structure and Dynamics of Complex Biological Systems

The biosciences have the potential to deliver scientific knowledge and strategies that can positively influence, even revolutionize, energy sustainability and security, aspects of materials science, environmental remediation, and global climate change. Understanding how nature designs and builds architectures ranging from the arrangements of atoms in proteins, through proteins as molecular machines that drive living processes, to the organelles and cells that package, regulate, and control the systems of life is truly an overarching grand challenge. Insight into the system dynamics is essential; systems that lack motion are profoundly inactive and ineffective. Conformational changes in macromolecules and their

complexes are central to the function of all enzymes and molecular machines. Conformational fluctuations in proteins and macromolecular complexes play a fundamental role in target recognition and functional switching. The flow of electrons is key to the capture, conversion, and storage of solar energy in photosynthesis. Dynamic structural techniques to complement the more conventional and widely-studied “static” atomic structures are crucial in all aspects of structural molecular biology and in gaining an understanding of the relationship between structure and function. Function is inherently a dynamic enterprise, as illustrated in Figure 72.

A molecular-level understanding of the structure of large macromolecules and their complexes, including membrane-bound proteins, the interactions between macromolecules that confer and control function, and ultimately the organization and networking of biomolecular assemblies at the cell and tissue levels, creates a knowledge base for the predictive understanding of complex biological systems from the sub-nanometer scale through the cellular level. A combination of experimental approaches, including macromolecular crystallography of sub-micron-sized crystals, microsecond to sub-picosecond time-resolved diffraction, and small-angle X-ray scattering experiments, will be needed to address complex problems. Information from such studies will be combined with that from other methodologies, such as imaging on the nanoscale and molecular dynamics simulations, to achieve a global or systems perspective. Success in this area could transform medicine, renewable energy research, environmental remediation, and other fields that are informed by or harness biological systems.

In this era of high-throughput genomics and proteomics, much is known about the production, modification, and structure of individual proteins. The evolving grand challenge is to characterize the “interactome” of a system—that is, the network of molecular-level interactions among proteins and other biological constituents that govern system functionality.

One of the most powerful elements in a multi-pronged approach is synchrotron-enabled macromolecular crystallography. The use of extremely bright X-ray micro-beams enables scientific discovery in the study of very small samples of crystalline materials. In order for this to be realized, there need to be concomitant developments in sample handling and orientation in the X-ray beam. Microcrystals need to be translated into the beam under extreme environments, as in Figures 73 and 74. Orienting may prove unnecessary if sample orientation can be recovered by suitable mathematical analysis of the individual diffraction patterns. Phasing could be accomplished by conventional multiwavelength anomalous dispersion (MAD) approaches or by iterative algorithms developed for diffraction microscopy.

These approaches to static structure determination may be extended to dynamic, time-resolved studies conducted in pump-probe mode. These require a coordinated means of initiating the desired structural reaction in the small crystal (for example, by a laser pulse) and the use of either a polychromatic X-ray beam in Laue diffraction or a convergent monochromatic beam. Although biological reactions span a wide time range, from femtoseconds (characteristic of atomic vibrations) to milliseconds or longer (characteristic of the turnover time of a representative enzyme), motions in the femtosecond to picosecond range are the most important and underpin all the slower motions. Such fast processes are fundamental to light harvesting and electron transfer processes in photosynthesis, for example.

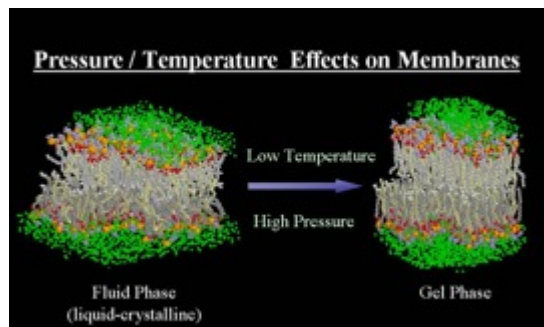

Figure 72 There is a need to understand the dynamics of membrane structures as a function of pressure, temperature, and chemical stress conditions to test theoretical models and develop bio-inspired energy materials capable of thriving in extreme environments [from D. Bartlett, Scripps Institution of Oceanography].

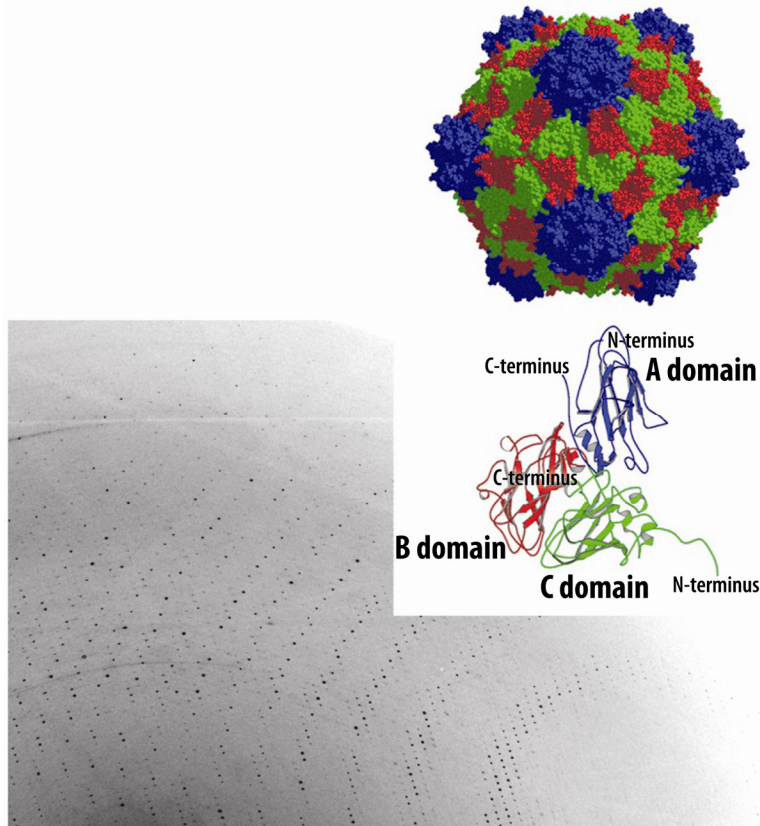

Figure 73 High-pressure single-crystal X-ray diffraction of cow pea mosaic virus. Next-generation techniques are required to determine the dynamical properties of large biological structures *in situ* [from T. Lin *et al.*, The mechanism of high-pressure-induced ordering in a macromolecular crystal, *Acta Cryst. D61*, 737-743 (2005)].

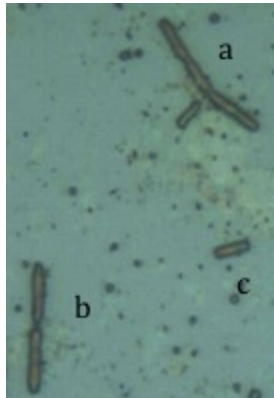

Figure 74 Dramatic morphology changes associated with pressurization of *E. coli* bacteria to 1000 MPa pressures. (a) exposed to elongate, (b) divide upon depressurization, and (c) finally return to normal size. Understanding and controlling this behavior requires subcellular imaging under high P-T conditions as well as x-ray structure studies *in situ*, both of which cannot be done with current x-ray sources (see Figure 50) [from P. Griffin, Carnegie Institution].

Combined with pump-probe techniques, nanofluidic mixers, and fast area detectors, high-brightness X-ray nanobeams will extend the time resolution of small- and wide-angle scattering measurements in solution well into the critical microsecond range and perhaps lower. For certain classes of experiments where conformational changes can be initiated by a pump, such as a light pulse, it will be possible to make atomic-resolution “snapshots” of evolving structures in solution. At this time scale, molecular dynamics calculations begin to overlap the observations, leading to a much richer and more accurate description of the processes involved. Strategies for conferring sensitivity to light on light-inert biological systems extend the range of pump-probe experiments. This technique promises to revolutionize the study of the dynamics not only of biological systems, but also of soft matter in general. Applications can be made to such fundamental problems as phase transitions and self-assemblies and to such technological processes as polymer mixing.

Flash Imaging of Cells and Other Biological Structures

How are macromolecular complexes organized into organelles, and organelles organized within the cell? Much of what we know in this area comes from electron microscopy, which provides superb resolution but is limited to very thin samples. In contrast, visible-light microscopy is limited in resolution but penetrates thicker samples. X-ray microscopy and, especially, cryo-X-ray tomography have been developing rapidly with the goal of filling the gap between electron microscopy and visible-light microscopy. This powerful new technique provides exciting results at the 30–50-nm spatial resolution level in intact cells, limited only by the quality of the available X-ray optics (Figure 75). To go beyond the limitation of optics, diffraction microscopy and ptychography (a technique for solving the phase problem by exposing and analyzing overlapping sample areas) are being developed. These lensless forms of 3-D X-ray microscopy require intense, coherent X-ray beams only available on next-generation light sources. Lensless microscopy can open broad new horizons for high-resolution 3-D imaging of single macromolecules.

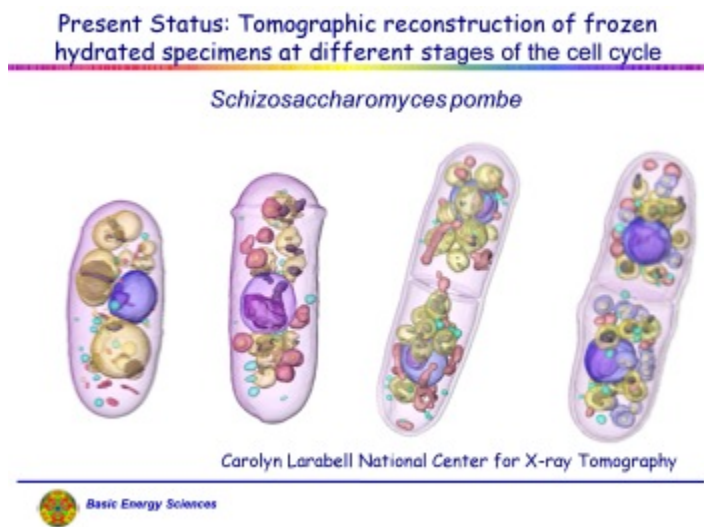

Figure 75 Tomographic 3-D imaging of a cell with soft x-rays (from Larabell *et al.*).

Coherent beams from FELs will revolutionize these approaches. Illumination with an ultrashort and extremely bright X-ray pulse can outrun key damage processes over a very short period of time. This can be exploited to extend the diffraction signal to the highest possible resolution in flash diffraction experiments, where spatial resolution well beyond that limited by conventional damage barriers can be achieved (Figure 76). A detailed analysis of imaging live cells with X-ray lasers suggests that nanometer to sub-nanometer resolution could be achieved with intense, ultrashort X-ray pulses at wavelengths of about 1.5–0.5 nm. This is substantially higher than the resolution possible in any other type of biological imaging experiments on non-reproducible objects, as well as subcellular imaging of the novel behavior of cells in extreme environments (Figure 74).

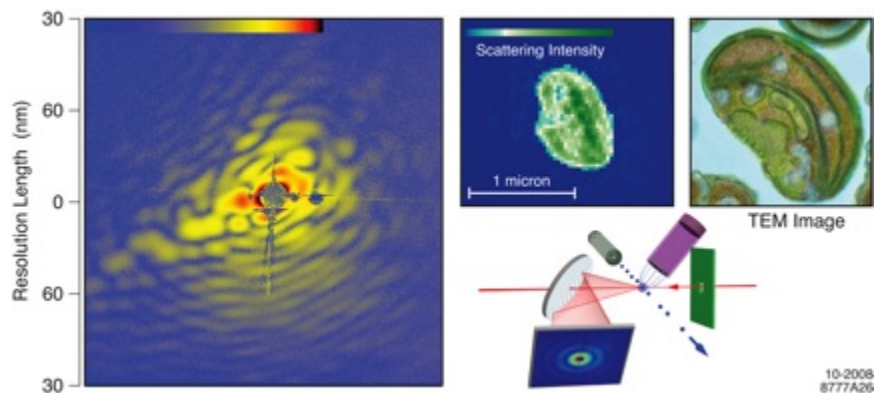

Figure 76 Left: Femtosecond single-shot X-ray scattering pattern. Top middle: The reconstructed image of a live picoplankton that was injected at 200 m/s into the beam of the soft X-ray laser FLASH operating at 7-nm wavelength, 15-fs pulse duration, and $\sim 10^{14}$ W/cm² power density. Image reconstructed using Shrinkwrap (Sebastien Boutet) (Source: J. Hajdu et al., private communication). Top right: transmission electron microscopy (TEM) image (Source: W. Eikrem and J. Thronsen, Univ. of Oslo). Bottom right: Schematic setup of diffraction experiment. The soft X-ray image can be extended to molecular resolutions with an X-ray laser operating in the wavelength range from 1.5 to 0.5 nm.

A high-resolution 3-D data set from a non-reproducible object would require simultaneous flash illumination by pulses from many directions. This could, in principle, ensure that significant damage does not develop during data collection. Orthogonal illumination could be realized with split-beam geometry and soft X-ray pulses for which efficient multilayer mirrors exist.

Mapping the Human Chromosome at the Atomic Level

The chromosome is an individual's blueprint. The molecular makeup of the chromosome can be sequenced, but its atomic structure has remained inaccessible. This stems from the reliance of current structural techniques on crystals consisting of at least 10^8 identical copies of a molecule. Next-generation X-ray sources will be able to collect diffraction patterns from individual molecules and viruses. A sequence of such patterns taken on identical copies of a molecule or virus in different orientations promises to reveal the atomic structure of non-crystallized molecules and viruses. The chromosome, however, can assume a wide range of non-identical conformations. New manifold embedding approaches promise to provide access to the atomic-level structure of such objects, provided that sufficiently bright X-ray sources are available.

In brief, given an ensemble of low-signal diffraction snapshots from different conformations of a chromosome, manifold embedding can be used to determine its structure *and* conformations at the atomic level. Thus, it should be possible to determine the atomic structure of a chromosome and gain access to its mechanical properties, providing unprecedented insight into the fundamental properties of the blueprint of life. More generally, it is increasingly clear that the conformation of biological entities can play a key role in their properties. The ability to map conformations would therefore represent a revolutionary advance in our understanding of key reactions in the life and energy sciences.

Metaphase chromosomes can be prepared in a form suitable to be injected into the exposure chamber one-by-one in a droplet stream. Using 10-fs X-ray pulses, a large number of diffraction patterns could be recorded. Collection of the diffraction data requires a fast area detector with low noise and high dynamic range. Development of the reconstruction algorithms will require concerted effort. Data handling and computation will require substantial resources.

Three-dimensional Biominerals and Nano-bio Interfaces

Biominerals and nano-bio interfaces are at the core of open problems in biology, medicine, and CO₂ sequestration. However, they cannot be analyzed in their native pristine form by means of current spectromicroscopy approaches, such as scanning transmission X-ray microscopy (STXM) and photoemission electron microscopy (PEEM), because these require 2-D sections of the 3-D objects. Using a soft X-ray FEL as the photon source, it is anticipated that scanning photoelectron spectromicroscopy (SPES) will enable the analysis of a high-topographic surface at the required spatial and chemical resolution.

While X-ray absorption near-edge structure (XANES) spectroscopy can already analyze the organic and mineral components (Figure 77), as well as the bonds formed at their interfaces, SPES will tackle and solve currently open problems, such as biofilm, mollusk shell, algal coccolith (Figure 78), biomineralization (Figure 79), and bone formation, with impact on climate change, osteoporosis, osteogenesis imperfecta, bio-inspired nanofabrication, and bioremediation. The novel SPES approach is inspired by beautiful high-relief scanning electron microscopy (SEM) images. SEM, however, cannot do spectroscopy *in situ*. SPES uses the same concept as SEM, with a normal incidence beam on a high-relief sample and a secondary-electron detector positioned on one side of the sample. The sample is mounted on a cryo-scanning stage. The beam is not an electron beam, but a focused soft X-ray beam from a FEL, with small spot size and small divergence.

The novelty is to have a large depth of field (that is, a small divergence in the soft X-ray beam). In order to make this a reality, there will need to be development in focusing the X-ray beam. Even at the currently achievable resolution of 100 nm, the development of SPES is highly informative because it enables spectroscopy on high-relief samples, without any sample preparation.

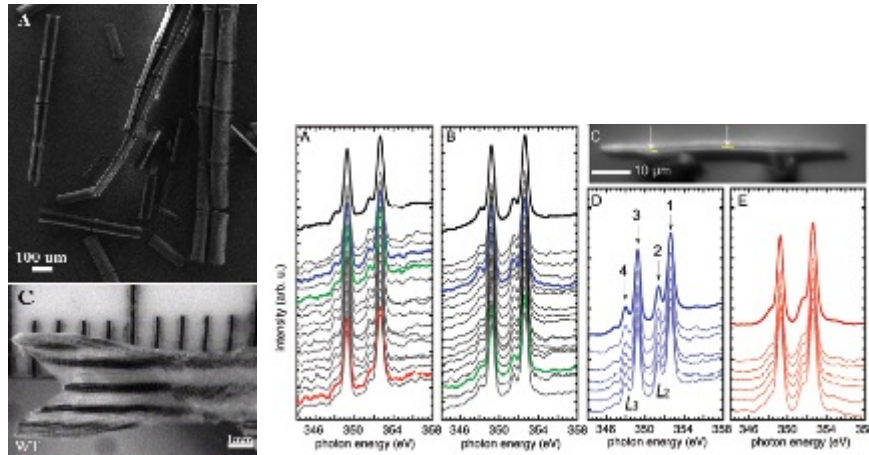

Figure 77 Amorphous to crystalline transition in sea urchin spicules. A few isolated spicules were analyzed with X-PEEM, with extreme difficulty. [From Y. Politi, R.A. Metzler, M. Abrecht, B. Gilbert, F. Wilt, I. Sagi, L. Addadi, S. Weiner, and P.U.P.A. Gilbert, “Mechanism of transformation of amorphous calcium carbonate into calcite in the sea urchin larval spicule,” *PNAS* **105**, 17362-17366 (2008).]

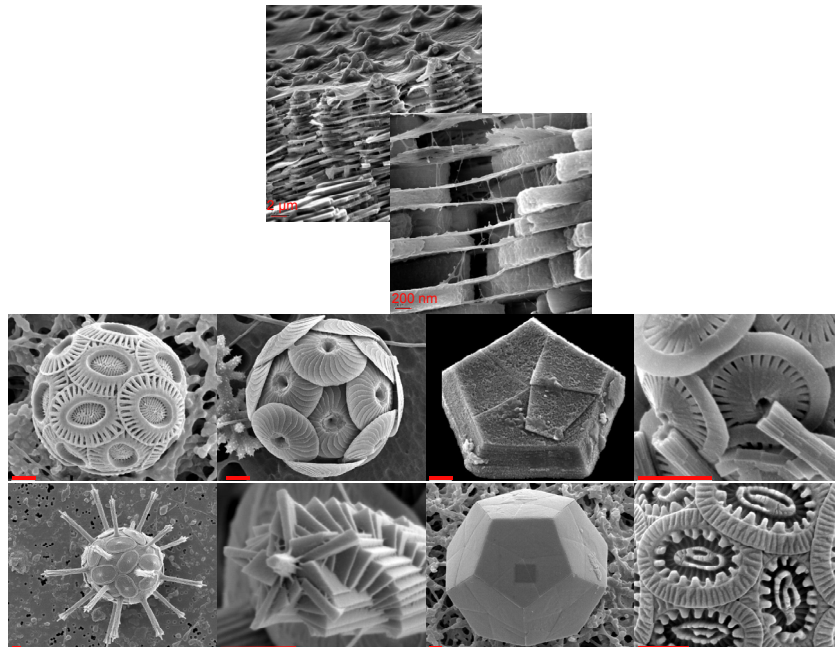

Figure 78 Coccolithophores are the greatest CO₂ sink on Earth (e.g. the white cliffs of Dover), yet little is known about the extraordinarily efficient mechanism leading to their formation. They can't be analyzed by PEEM or STXM; SPES is needed. They also hide new secrets for bio-inspired nanofabrication. All scale bars in red are 1 μm. (Images from Jeremy Young's web site, National History Museum, London, www.nhm.ac.uk.)

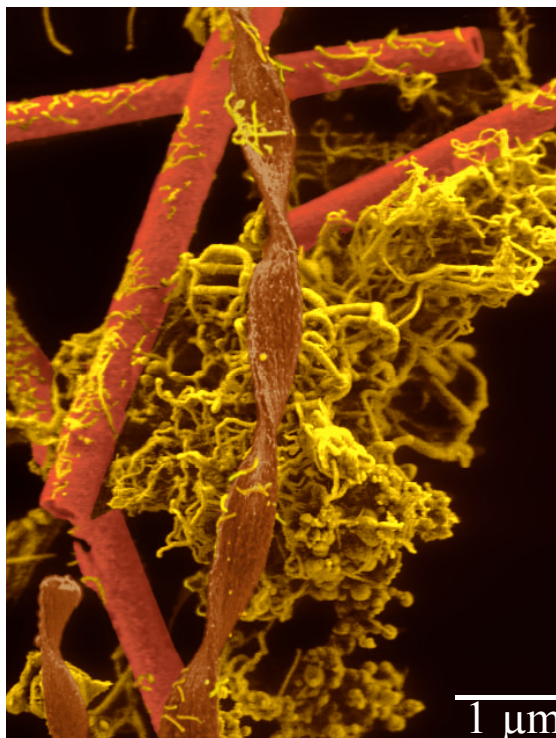

Figure 79 PEEM and STXM images and spectra were taken only from isolated small structures. We need to see these high-relief structures and do spectroscopy on their surface with SPES. ZnS (left) and FeOOH (right) precipitating bacteria, from M. Labrenz, G. K. Druschel, T. Thomsen-Ebert, B. Gilbert, S. A. Welch, K. M. Kemner, G. A. Logan, R. E. Summons, G. De Stasio, P. L. Bond, B. Lai, S. D. Kelly, and J. F. Banfield, “Sphalerite (ZnS) deposits forming in natural biofilms of sulfate-reducing bacteria”, *Science* **290**, 1744-47 (2000) and C. S. Chan, G. De Stasio, S. A. Welch, M. Girasole, B. H. Frazer, M. Nesterova, S. Fakra, and J. F. Banfield, “Microbial polysaccharides template assembly of nanocrystal fibers,” *Science* **303**, 1656-1658 (2004). Organic-mineral interface in bacterial biofilms (bioremediation).

Understanding the Role of Metals and Metallo-Enzymes in Health, Disease, and the Environment

X-ray fluorescence combined with X-ray absorption spectroscopy offers superb trace-element sensitivity and the ability to determine chemical speciation and local electronic and geometric structure of metal constituents in biological systems. To understand the biological significance of trace elements (especially metals) in health, disease, and pharmacological treatment, it is important to determine their three-dimensional distribution, their concentration, and their chemical state in cells and tissues, as well as their many roles as key components of proteins and macromolecular complexes. For example,

- Typically, 25–30% of a given genome codes for proteins that contain or involve metals.
- Nutritional and/or toxicological challenges, together with other failures of metal homeostasis, are important in disease.
- Metal-ion trafficking shows emergent behavior, with often unanticipated interactions between metals (e.g., Cd poisoning causes Cu uptake and localization).

- Cells show cell-to-cell variation in metal concentrations that are much larger than measurement error.

Important first steps toward the high-resolution mapping of trace elements have been taken at third-generation light sources, but limitations in source brightness have made the process too slow to make a major impact. Moreover, advances are needed in spatial resolution. Significantly higher average-brightness X-ray sources are required to bring this technique into the forefront of metal toxicology, pharmacology, and physiology. Increased brightness will also enable the study of metal-containing systems at *in vivo* concentrations, and under conditions where they are actually undergoing reactions and changes in the sub-millisecond time domain. In addition, use of genetically encoded metal-binding tags could open up the study of sub-cellular localization of any protein of interest.

In all areas of life science and soft matter research with X-rays, radiation damage is a critical limitation. As one moves to higher resolution, smaller samples, and higher sensitivity, one needs to be even more careful in the design of the experiment to make sure that the information collected is not compromised. Considerable effort is being expended on understanding these issues and finding mitigation strategies. In some cases, making the exposure at cryogenic temperatures is sufficient. In other cases, a useful approach is to continually refresh samples, using nanofluidics, a stream of molecules, or droplets.

References

- [1] “Directing Matter and Energy: Five Challenges for Science and the Imagination,” www.sc.doe.gov/bes/reports/list.html.
- [2] Basic Research Needs workshop reports, www.sc.doe.gov/bes/reports/list.html.
- [3] F. Jiang, A. Munkholm, R.-V. Wang, S.K. Streiffer, C. Thompson, P.H. Fuoss, K. Latifi, K.R. Elder, and G.B. Stephenson, “Spontaneous Oscillations and Waves during Chemical Vapor Deposition of InN,” *Phys. Rev. Lett.* **101**, 086102 (2008).
- [4] Lin X. Chen, “Excited state molecular structure determination in disordered media using laser pump/X-ray probe time-domain X-ray absorption spectroscopy” *Faraday Discuss.*, 2002, **122**, 315–329.
- [5] A.J. Nozik, “Quantum dot solar cells,” *Physica E: Low-dimensional Systems and Nanostructures* **14**, 115-120 (2002).
- [6] M.C. Beard and R.J. Ellingson, “Multiple exciton generation in semiconductor nanocrystals: Toward efficient solar energy conversion,” *Laser & Photon. Rev.* **2**, No. 5, 377–399 (2008).

APPENDIX 3: RELATED STUDIES

- [1] National Science Foundation, Light Source Panel Report, September 15, 2008.
http://www.nsf.gov/mps/dmr/LSPanel_FinalRPT_wCorrections9_15_08.pdf
- [2] Science and Technology of Future Light Sources; A White Paper, December 2008. Argonne National Laboratory, Brookhaven National Laboratory, Lawrence Berkeley National Laboratory, and Stanford Linear Accelerator Center. Editors: Arthur L. Robinson (LBNL) and Brad Plummer (SLAC). ANL-08/39, BNL-81895-2008, LBNL-1090E-2009, SLAC-R-917.
<http://www-ssrl.slac.stanford.edu/aboutssrl/documents/future-x-rays-09.pdf>
- [3] Toward Control of Matter: Energy Science Needs for a New Class of X-Ray Light Sources, Report of the Workshop on Science for a New Class of Soft X-Ray Light Sources, Lawrence Berkeley National Laboratory, September 2008. https://hpcrd.lbl.gov/sxls/Workshop_Report_Final.pdf
- [4] FLASH, the Free-Electron Laser in Hamburg , DESY, Hamburg 2007.
<http://www.lightsources.org/images/brochures/FLASHbrochure.pdf>
- [5] The Linac Coherent Light Source (LCLS) at SLAC.
<http://www-ssrl.slac.stanford.edu/lcls/science.html>
- [6] SPring-8 Joint Project for XFEL, RIKEN and JASRI, 2007.
<http://www.riken.jp/XFEL/download/XFELeng.pdf>
- [7] Science Case for a New Light Source (NLS), Jon Marangos *et al.*, October 2008.
<http://www.newlightsource.org/documents/NLS%20Science%20Case%203Oct08.pdf>
- [8] Visions of Science: The BESSY SASE-FEL in Berlin-Adlershof, Berlin, 2001.
<http://www.bessy.de/publicRelations/publications/files/sc.pdf>
- [9] Collaborative Research: Conceptual Design Study and R&D for a VUV/Soft X-ray Free Electron Laser User Facility, University of Wisconsin-Madison and MIT, November 2007.
http://www.wifel.wisc.edu/WiFEL_R&D_Proposal.pdf

ADDITIONAL WEB LINKS ON NEXT-GENERATION LIGHT SOURCES

Free Electron Lasers and Other Advanced Sources of Light: Scientific Research Opportunities.
<http://www.nap.edu/openbook.php?isbn=NI000099>

European XFEL.
<http://xfelinfo.desy.de/en/thema.forschung/2/index.html>

XFELinfo: Understandable need-to-knows about the European X-ray laser project XFEL
<http://xfelinfo.desy.de/en/druckversion/xfelinfo-2.pdf>

4GLS Science Landscapes.
http://www.4gls.ac.uk/Documents/4GLS_Landscapes.pdf

FEL 2006 Proceedings.
<http://www.bessy.de/fel2006/proceedings/>

LCLS: A New Era of Science.
<http://www-ssrl.slac.stanford.edu/lcls/science.html>

Talks for the FEL Workshop held October 18-19, 2006.
<http://www.src.wisc.edu/meetings/fel2006/talks2/index.htm>

FEL Symposium, October 11, 2007: Plans for the Wisconsin Free Electron Laser Facility: Preliminary Design Performance and Scientific Opportunities.
<http://www.wifel.wisc.edu/science/symposium07/talks.htm>

Wisconsin FEL.
<http://www.wifel.wisc.edu/>

CMMP 2010 Facilities Workshop.
http://www7.nationalacademies.org/bpa/CMMP2010_Facilities_Workshop.html

CMMP Presentation by Franz Himpsel.
http://www7.nationalacademies.org/bpa/CMMP2010_Facilities_Presentation_Himpsel.pdf

Challenges and Opportunities in Condensed Matter and Material Physics: The Need for Light Source Facilities. Presenter: Roger Falcone.
http://www7.nationalacademies.org/bpa/CMMP2010_Facilities_Presentation_Falcone.pdf

ERL X-ray Science Workshops at Cornell.
<http://erl.chess.cornell.edu/gatherings/erl%20workshop/index.htm>

Fourth generation upgrade to the Advanced Photon Source (APS): An Energy Recovery LINAC.
http://www7.nationalacademies.org/bpa/cmmp2010_facilities_presentation_gibson.pdf

PEP-X Project Overview, Stanford University.
<http://www-ssrl.slac.stanford.edu/pep-x/overview.html>

http://www-ssrl.slac.stanford.edu/publications/mtg_summaries.html

Agenda: Science for a New Class of Soft X-ray Light Sources, Doubletree Hotel & Executive Meeting Center, Berkeley Marina, Berkeley, California.
http://hpcrd.lbl.gov/sxls/sxls_draft_agenda.pdf

APPENDIX 4: PHOTON WORKSHOP CHARGE

Solving Science and Energy Grand Challenges with Next-Generation Photon Sources

The Photon Workshop

Hilton Washington DC/Rockville Executive Meeting Center,
Rockville, Maryland
<http://www.rockvillehotel.com/>

This workshop (briefly labeled “Photon Workshop”) will identify connections between major new research opportunities and the capabilities of the next generation of light sources (“photon attributes,” such as coherence and femtosecond time resolution; see below for a more complete list). Particular emphasis will be on energy-related research. The presentations and discussion sessions will highlight how time-resolved excitation, functional imaging, diffraction, and spectroscopy by photons can help solve major problems and develop “killer applications” in basic energy research. A variety of opportunities have been outlined by ten BESAC and BES reports on basic research needs and by a report on five “Grand Challenges” in directing matter and energy (see: <http://www.sc.doe.gov/bes/reports/list.html>).

Both accelerator-based light sources and novel laser-based sources for the VUV to X-ray range will be considered. The Photon Workshop will identify the science drivers for new photon sources but will not consider the design of machines or devices for producing the required photons. A strong coupling of theory and experiment will be emphasized.

The task of the Photon Workshop can be summarized by a *matrix* that defines the most compelling *connections* between *research opportunities* and *photon attributes*. A sample matrix is prepared on a separate sheet. For example, many science and energy grand challenges require probing very fast processes that happen over very small distances: femtoseconds over nanometers. Typically, an electron in a solid takes a femtosecond to travel a nanometer, and atoms have a vibrational period of about 100 femtoseconds. Lasers probe femtoseconds and synchrotrons resolve nanometers, but presently neither can do both.

The photon attributes to be considered by the workshop include coherence length (longitudinal and transverse), time structure, energy, energy resolution, spectral brightness (average and peak), flux, spatial and momentum resolution, and polarization.

Charge to Science Opportunity Speakers

New science opportunities will be discussed in the nine breakout sessions shown in the program. Speakers will be allowed up to 10 minutes to present a new science opportunity that would be enabled by extending the present limits of photon attributes listed above, in particular coherence and fast time structure. Because many participants are already familiar with photon science, introductory material can be kept to a minimum. Talks should define the new science opportunities, discuss their impact on the field, and specify the range of photon attributes required to achieve a significant advance of the scientific frontier. Discussion of specific applications that are compelling enough to drive opinion of the community (“killer applications”) is invited.

The specific machines and devices for producing the required photon attributes are not to be treated. Talks are to present only the science drivers and required photon attributes.

Please provide one week in advance the viewgraphs for your talk and a two-page extended abstract identifying the new science opportunities, the impact of advancing the frontier of science or enabling a new approach to energy production or utilization, and the photon attributes required to realize this opportunity.

Charge to Technology Summary Speakers

The Photon Workshop will open with a review of the range of photon attributes that is expected to be produced by free electron lasers, energy recovery linacs, third-generation synchrotrons, and laser-based sources for the VUV and X-ray photon energy range. These short survey talks will focus on the character of the photons that can potentially be produced, to set the stage for the workshop discussion of the new science opportunities that they enable. The photon attributes to be considered include those listed above.

Technology Summary speakers are allotted 20 minutes to present an overview of the photon attributes achievable by various light sources. Please submit your viewgraphs one week before the workshop for distribution to participants.

Charge to Breakout Session Coordinators

The breakout sessions will discuss the research opportunities, divided into nine broad areas, and establish their major connections to photon attributes. The breakout sessions begin with short (<10 min) presentations by session participants that outline the most significant connections between their area of expertise and the capabilities of the next-generation light sources.

The bulk of the breakout sessions will be dedicated to develop a short summary of the findings (about 3 PowerPoint slides and 3 pages of narrative). These will be presented in the following plenary session on Tuesday and critically discussed. Breakout sessions will re-convene Tuesday afternoon to refine and finalize their viewgraphs and narratives. These are the primary output of the sense of the workshop.

The reports of the breakout groups will be combined into one document by the New Era Subcommittee, to be presented at a meeting of the full BESAC on Nov. 20-21.

Template for Session Coordinators:

- List the most significant connections between research opportunities and photon attributes (a matrix illustrating possible connections is provided separately). Give an approximate ranking. Quantify the photon attributes that are critical for each application. Identify which new features of next-generation light sources enable the research.
- Provide a rationale that is suitable for presenting to congressional staffers and other policy makers. Give examples from daily life including familiar problems. Graphics accessible to a technically literate but non-expert audience are specifically requested.

APPENDIX 5: PHOTON WORKSHOP AGENDA

Solving Science and Energy Grand Challenges with Next-Generation Photon Sources

“The Photon Workshop”

Hilton Washington DC/Rockville Executive Meeting Center,
Rockville, Maryland
<http://www.rockvillehotel.com/>

Agenda

Sunday Evening, October 26, 2008

- 6:30-8:00 pm Working Dinner (Workshop Executive Committee*, by invitation)
*Executive Committee includes plenary speakers, Breakout Group Coordinators,
and New Era Subcommittee members.
- 8:00-9:30 pm Pre-meeting Reception (everyone)

Monday Morning, October 27, 2008

- 7:30-8:30 am Continental Breakfast and Registration

Plenary session: Introduction and Science Challenges – Plaza II and III

- 8:30-9:00 am Introduction and Charge by BES/BESAC representatives (30 min total) Pat Dehmer, Deputy Director for Science Programs, Office of Science Harriet Kung, Associate Director of Science for Basic Energy Sciences John Hemminger, Chair, Basic Energy Sciences Advisory Committee
- 9:00-9:45 am Facing the Energy Challenge (30+15)
George Crabtree, Argonne National Laboratory
- 9:45-10:30 am Grand Challenges in Life Sciences (30+15)
Keith Moffat, University of Chicago

10:30-10:50 am Break

Plenary Session: Technology Status

- 10:50-11:10 am Free Electron Lasers (15+5) Claudio Pellegrini, UCLA
- 11:10-11:30 am Energy Recovery Linacs (15+5) Georg Hoffstaetter, Cornell
- 11:30-11:50 am Future Conventional Lasers (15+5) Wolfgang Sandner, Max Born Institute, Berlin

11:50-12:10 pm 3rd Generation Synchrotrons (15+5) Nils Martensson, Lund University, Sweden

12:10-1:30 pm Working Lunch - Breakout Groups discuss organization and content

Monday Afternoon, October 27, 2008

1:30-5:30 pm Short presentations and preparation of 3 summary slides in each group

Breakout into 9 Discussion Groups:

Group 1: Nanoscale Electrons and Spins – Lincoln Room

Coordinator: Hermann Dürr (Berlin)

Group 2: Correlated Electrons – Madison Room

Coordinator: Z. X. Shen (Stanford)

Group 3: Catalysis and Chemistry – Jackson Room

Coordinator: Robert Schlögl (FHI Berlin)

Group 4: Nano-Materials for Energy Applications – Monroe Room

Coordinator: Rick Osgood (Columbia)

Group 5: Life Sciences – Jefferson Room

Coordinator: Janos Kirz (Berkeley)

Group 6: Atomic and Molecular Physics – Truman Room

Coordinator: Nora Berrah (Western Michigan)

Group 7: Matter under Extreme Environments, Environmental Science, Earth Science – Twinbrook Room

Coordinator: Rus Hemley (Washington, D.C.)

Group 8: Novel Structural and Electronic Materials – Wilson Room

Coordinator: Julia Phillips (Sandia)

Group 9: Techniques and Cross-Cutting Issues – Plaza I

Coordinator: John Hemminger (Irvine)

Monday Evening, October 27, 2008

6:00 pm Working Dinner: Feedback session Q&A for discussion leaders

Tuesday Morning, October 28, 2008

7:30-8:30 am Continental Breakfast

Breakout into discussion groups

8:30-10:15 am Final preparation of 3 summary slides/science driver, using ppt template on workshop website

10:15-10:30 am Break

Plenary session: Reports of Breakout Groups

10:30-12:00 Reports from the discussion leaders (5+5 min each)

12:00-12:10 pm General suggestions from participants, BES personnel, New Era members

12:10-1:30 pm Working Lunch – Cross-group discussion, one discussion coordinator at each table

Tuesday Afternoon, October 28, 2008

Breakout into discussion groups:

1:30-5:30 pm Finalize breakout reports, 3 ppt slides and 3 page text summary per science driver, using the ppt and doc templates on the workshop website.

Tuesday Evening, October 28, 2008

6:00 pm Working Dinner Outline the final report

Wednesday Morning, October 29, 2008

Departure of Workshop Participants (except Executive Committee)

7:30-8:30 am Continental Breakfast

8:00-1:00 pm Workshop Report Preparation (Executive Committee, by invitation) Combine the reports, prepare bullets for executive summary, define homework for a handout and presentation at the BESAC meeting on November 20-21, 2008.

APPENDIX 6: PHOTON WORKSHOP PARTICIPANTS

**Photon Workshop
October 26-29,
2008 Participant List**

Last Name	First Name	Workshop Role	Affiliation	E-mail Address
Alivisatos	Paul	Panelist, Group 4	LBL	APAlivisatos@lbl.gov
Astheimer	Bob	Observer	DOE/BES	robert.astheimer@science.doe.gov
Bare	Simon	Panelist, Group 3	UOP	simon.bare@uop.com
Bergmann	Uwe	Panelist, Group 3	Stanford U	bergmann@slac.stanford.edu
Berrah	Nora	Breakout Coordinator, Group 6	U of Western Michigan	nora.berrah@wmich.edu
Bouldin	Charles	Observer	NSF	cbouldin@nsf.gov
Brown	Gordon	Panelist, Group 7	Stanford	Gordon.Brown@stanford.edu
Buchanan	Michelle V.	New Era Subcommittee Member	ORNL	buchananmv@ornl.gov
Bucksbaum	Phil	Panelist, Group 6	Stanford U	phb@slac.stanford.edu
Burrow	Richard	Workshop Coordination	DOE/BES	richard.burrow@science.doe.gov
Burrows	Paul	Panelist, Group 8	Organic Devices	organicdevices@clearwire.net
Campuzano	Juan Carlos	Panelist, Group 2	UIC/ANL	JCC@UIC.EDU
Casassa	Michael P.	New Era Subcommittee Member	DOE/BES	michael.casassa@science.doe.gov
Cerrina	Franco	Panelist, Group 8	Boston U	cerrina@bu.edu
Chen	Lin	Panelist, Group 3	ANL	lchen@anl.gov
Chiang	T.C.	Panelist, Group 1	UIUC	chiang@mrl.uiuc.edu
Chiang	Yet-Ming	Panelist, Group 4	MIT	ychiang@mit.edu
Collins	G.W. (Rip)	Panelist, Group 7	LLNL	collins7@llnl.gov
Crabtree	George	New Era Chair	ANL	crabtree@anl.gov
Dehmer	Pat	Plenary Speaker	DOE-SC	patricia.dehmer@science.doe.gov
DePaolo	Don	New Era Subcommittee Member	U of California, Berkeley	depaolo@eps.berkeley.edu
Devereaux	Tom	Panelist, Group 2	SLAC/Stanford	tpd@slac.stanford.edu
Dierker	Steve	Panelist, Group 9	BNL	dierker@bnl.gov
Dürr	Hermann	Breakout Coordinator, Group 1	BESSY, Berlin	hermann.duerr@bessy.de
Eberhardt	Wolfgang	Workshop Chair	BESSY, Berlin	eberhardt@bessy.de
Eisebitt	Stefan	Panelist, Group 1 and Group 5	BESSY, Berlin	eisebitt@bessy.de
Ewing	Rod	Panelist, Group 7	U of Michigan	rodewing@engin.umich.edu
Falcone	Roger	Panelist, Group 9	UC Berkeley/LBL	RWFalcone@lbl.gov
Funk	David	Panelist, Group 7	LANL	djf@lanl.gov
Gaffney	Kelly	Panelist, Group 6	SLAC/Stanford	kgaffney@slac.stanford.edu

Gibson	Murray	Panelist, Group 9	ANL	jmgibson@aps.anl.gov
Gilbert	Pupa	Panelist, Group 5	U Wisconsin-Madison	pupa@physics.wisc.edu
Glownia	James	Observer	DOE/Office of Science	james.glownia@science.doe.gov
Guebrea	Tessema	Observer	NSF	gtessema@nsf.gov
Gupta	Yogi	Panelist, Group 7	Washington State U	ymgupta@wsu.edu
Hasan	Zahid	Panelist, Group 2	Princeton U	mzhasan@princeton.edu
Hemley	Rus	Breakout Coordinator, Group 7	Carnegie Institution Washington	hemley@gl.ciw.edu
Hemminger	John C.	Plenary Speaker and Breakout Coordinator, Group 9	UC Irvine/BESAC Chair	jchemmin@uci.edu
Hendrickson	Wayne	Panelist, Group 5	Columbia U	wayne@convex.hhmi.columbia.edu
Himpfel	Franz J.	Workshop Chair	U of Wisconsin	fhimpfel@wisc.edu
Hodgson	Keith	Panelist, Group 5	Stanford/SLAC	hodgson@ssrl.slac.stanford.edu
Hoffstaetter	Georg	Plenary Speaker	Cornell U	hoff@mail.lepp.cornell.edu
Horwitz	James	New Era Subcommittee Member	DOE/BES	james.horwitz@science.doe.gov
Hussain	Zahid	Panelist, Group 2	LBNL	ZHussain@lbl.gov
Ice	Gene	Panelist, Group 4	ORNL	icege@ornl.gov
Johansson	Borge	Panelist, Group 8	Uppsala	borje.johansson@fysik.uu.se
Johnson	Peter	Panelist, Group 2	BNL	pdj@bnl.gov
Kao	Chi-Chang	Panelist, Group 9	BNL	kao@bnl.gov
Kastner	Marc	New Era Chair	MIT	mkastner@MIT.EDU
Kelley	Richard	Observer	DOE/BES	richard.kelley@science.doe.gov
Kevan	Steve	Panelist, Group 1	U of Oregon, Eugene	kevan@physics.uoregon.edu
Kerch	Helen	Observer	DOE/BES	helen.kerch@science.doe.gov
Kiess	Thomas	Observer	DOE/BES	thomas.kiess@science.doe.gov
Kirz	Janos	Breakout Coordinator, Group 5	Berkeley	janos.kirz@sunysb.edu/jkirz@lbl.gov
Klaffky	Roger W.	New Era Subcommittee Member	DOE/BES	roger.klaffky@science.doe.gov
Klein	Michael L.	Panelist, Group 6	U of Pennsylvania	klein@lrsm.upenn.edu
Kortan	Refik	Observer	DOE/BES	refik.kortan@science.doe.gov
Krause	Jeff	Observer	DOE/BES	jeff.krause@science.doe.gov
Kung	Harriet	Plenary Speaker	DOE-BES	Harriet.Kung@science.doe.gov
Larabell	Carolyn	Panelist, Group 5	UC San Francisco	carolyn.larabell@ucsf.edu
Lineberger	Carl	Groups 3 and 6 and New Era	U of Colorado	wcl@jila.colorado.edu
Looney	Pat	New Era Subcommittee Member	BNL	jlooney@bnl.gov
Mailhot	Christian	Panelist, Group 7	LLNL	christian.mailhoit@nnsa.doe.gov
Mallouk	Thomas E.	Group 4 and New Era	Penn State U	tom@chem.psu.edu
Mandrus	David	Panelist, Group 2	ORNL	mandrusdg@ornl.gov
Markovic	Nenad	Panelist, Group 3	ANL	nmmarkovic@anl.gov
Martensson	Nils	Plenary Speaker	Lund University Sweden	Nils.Martensson@maxlab.lu.se

Maupin	Paul	Observer	DOE/BES	paul.maupin@scienc.doe.gov
McCurdy	Bill	Panelist, Group 6 and Group 9	UC Davis/LBL	cwmccurdy@lbl.gov or cwmccurdy@ucdavis.edu
Miller	John C.	Observer	DOE/BES	john.miller@science.doe.gov
Miranda	Raul	Observer	DOE/BES	raul.miranda@science.doe.gov
Moffat	Keith	Plenary Speaker and Panelist, Group 5	U of Chicago	moffat@cars.uchicago.edu
Moncton	David	Panelist, Group 9	MIT	dem@mit.edu
Mandrus	David	Panelist, Group 2	ORNL	mandrusdg@ornl.gov
Montano	Pedro	Observer	DOE/BES	pedro.montano@science.doe.gov
Morss	Lester	Observer	DOE/BES	lester.morss@science.doe.gov
Mukamel	Shaul	Panelist, Group 6	UC Irvine	smukamel@uci.edu
Norman	Michael	Panelist, Group 2 and New Era	ANL	norman@anl.gov
Nozik	Arthur J.	Groups 3 and 4 and New Era	NREL	arthur_nozik@nrel.gov
Oddone	Patricia	Panelist, Group 9	LBNL	ploddone@lbl.gov
Osgood	Rick	Breakout Coordinator, Group 4	Columbia	osgood@columbia.edu
Ourmazd	Abbas	Panelist, Group 5 and Group 8	U Wisconsin-Milwaukee	ourmazd@uwm.edu
Parise	John	Panelist, Group 4	Stony Brook	jparise@notes.cc.sunysb.edu
Pelligrini	Claudio	Plenary Speaker	UCLA	pellegrini@physics.ucla.edu and cpellegrini@roadrunner.com
Phillips	Julia	Breakout Coordinator, Group 8	Sandia	jmphill@sandia.gov
Rahn	Larry	Observer	DOE/BES	larry.rahn@science.doe.gov
Rohlfing	Eric	Observer	DOE/BES	eric.rohlfing@science.doe.gov
Sandner	Wolfgang	Plenary Speaker	MBI Berlin	sandner@mbi-berlin.de
Sarrao	John L.	Group 2 and Group 7 and New Era	LANL	sarrao@lanl.gov
Schlögl	Robert	Breakout Coordinator, Group 3	FHI Berlin	acsek@fhi-berlin.mpg.de
Schneider	Jochen	Panelist, Group 9	SLAC	jrs@SLAC.Stanford.EDU
Schoenlein	Bob	Panelist, Group 2	LBNL	RWSchoenlein@lbl.gov
Schwartz	Andrew	Observer	DOE/BES	andrew.schwartz@science.doe.gov
Shen	Guoyin	Panelist, Group 7	ANL/APS	gshen@hpcat.aps.anl.gov
Shen	Z.X.	Breakout Coordinator, Group 2	Stanford University	zxshen@stanford.edu
Shenoy	Gopal	Panelist, Group 9	ANL	gks@aps.anl.gov
Stair	Peter	Panelist, Group 3	Northwestern U	pstair@northwestern.edu
Stephenson	Brian	Panelist, Group 8	ANL	stephenson@anl.gov
Stöhr	Jo	Panelist, Group 1	SLAC	stohr@slac.stanford.edu
Swain	Amy	Observer	NIH	SwainA@mail.nih.gov
Talamini	Karen	Workshop Coordination	DOE/Office of Science	karen.talamini@science.doe.gov
Taylor	Toni	Panelist, Group 8	LANL	ttaylor@lanl.gov
Tiede	David	Panelist, Group 4	ANL	tiede@anl.gov

Tranquada	John	Observer/BESAC Member	BNL	jtran@bnl.gov
Turner	John	Panelist, Group 3	NREL	john_turner@nrel.gov
Wang	Lai Sheng	Panelist, Group 6	Washington State U	ls.wang@pnl.gov
Waychunas	Glenn	Panelist, Group 7	LBNL	GAWaychunas@lbl.gov
Weightman	Peter	Panelist, Group 1 and Group 4	U of Liverpool	peterw@liverpool.ac.uk
Wilson	Lane	Observer	DOE/BES	lane.wilson@science.doe.gov
Winter	Bernd	Panelist, Group 6	BESSY, Berlin	bwinter@mbi-berlin.de
Young	Linda	Panelist, Group 6	ANL	young@anl.gov
Zinkle	Steve	Panelist, Group 7	ORNL	zinklesj@ornl.gov

DISCLAIMER

This report was prepared as an account of work sponsored by an agency of the United States Government. Neither the United States government nor any agency thereof, nor any of their employees, makes any warranty, express or implied, or assumes any legal liability or responsibility for the accuracy, completeness, or usefulness of any information, apparatus, product, or process disclosed, or represents that its use would not infringe privately owned rights. Reference herein to any specific commercial product, process, or service by trade name, trademark, manufacturer, or otherwise, does not necessarily constitute or imply its endorsement, recommendation, or favoring by the United States Government or any agency thereof. The views and opinions of authors expressed herein do not necessarily state or reflect those of the United States Government or any agency thereof.

The report is available online at
<http://www.sc.doe.gov/bes/reports/list.html>

Publishing support services provided by Argonne National Laboratory

