

# US ITER Project Status

*Progress on Preparations*

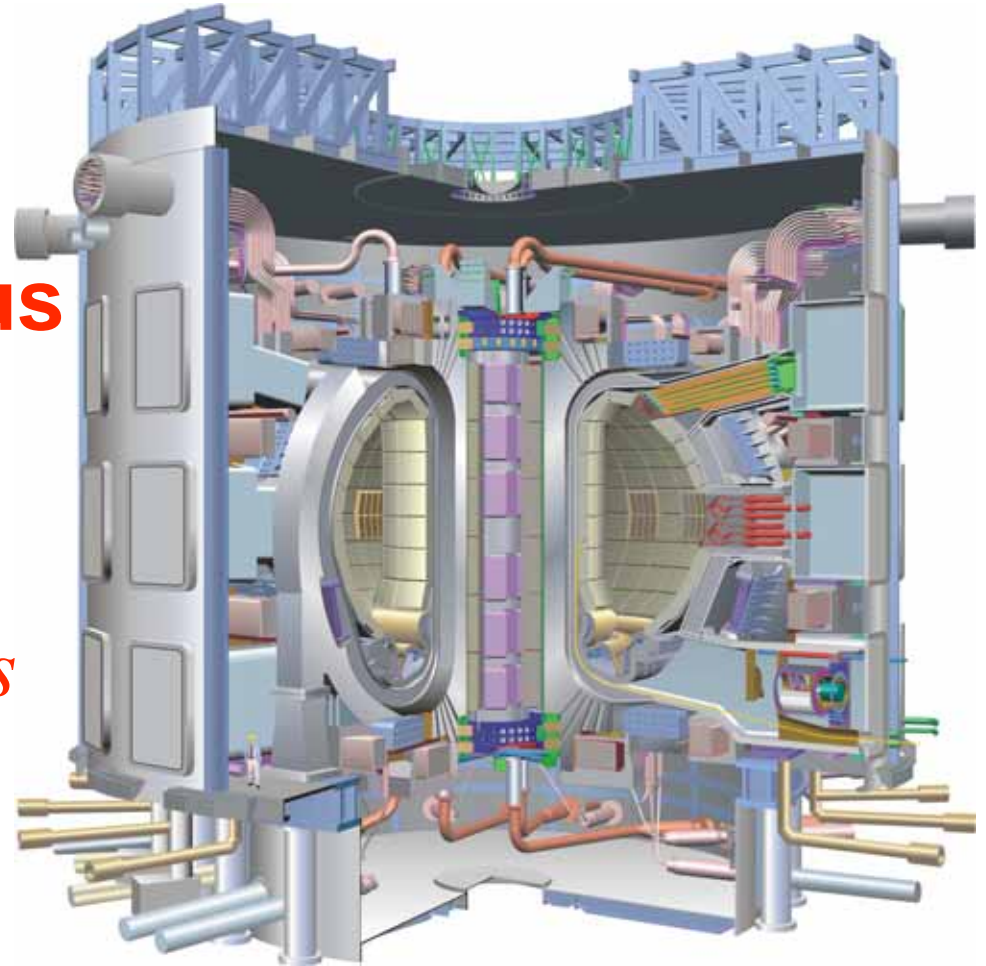

Fusion Energy Sciences Advisory Committee  
Gaithersburg, Maryland

Ned Sauthoff  
April 8, 2005

# Outline: Key Topics in this Preparatory Phase

---

- **Technical Activities**

- Addressing risk in the US in-kind contributions and enhancing ITER's research capabilities

- **Project Management**

- Increasing effectiveness during the ITER Transitional Arrangements (International Team/Participant Team Leaders meeting 2/05)
- FY06 budget scenarios
- DOE/SC Review 3/22-24/05

## R&D and design activities

---

- **The International Team is updating the design documentation to enable an effective transition to the Central Team**
- **The US team is focusing on mitigating areas of risk in its provisionally-allocated in-kind contributions**
  - Performing R&D, prototyping, and design work in areas of US in-kind contributions
    - in partnership with the VLT in areas of mutual benefit
    - with ITER-Direct funding for industrial procurements, secondees, project staff
  - Focusing on high-risk near-term issues, such as magnets and blankets

# U.S. provisional “in-kind contribution” scope

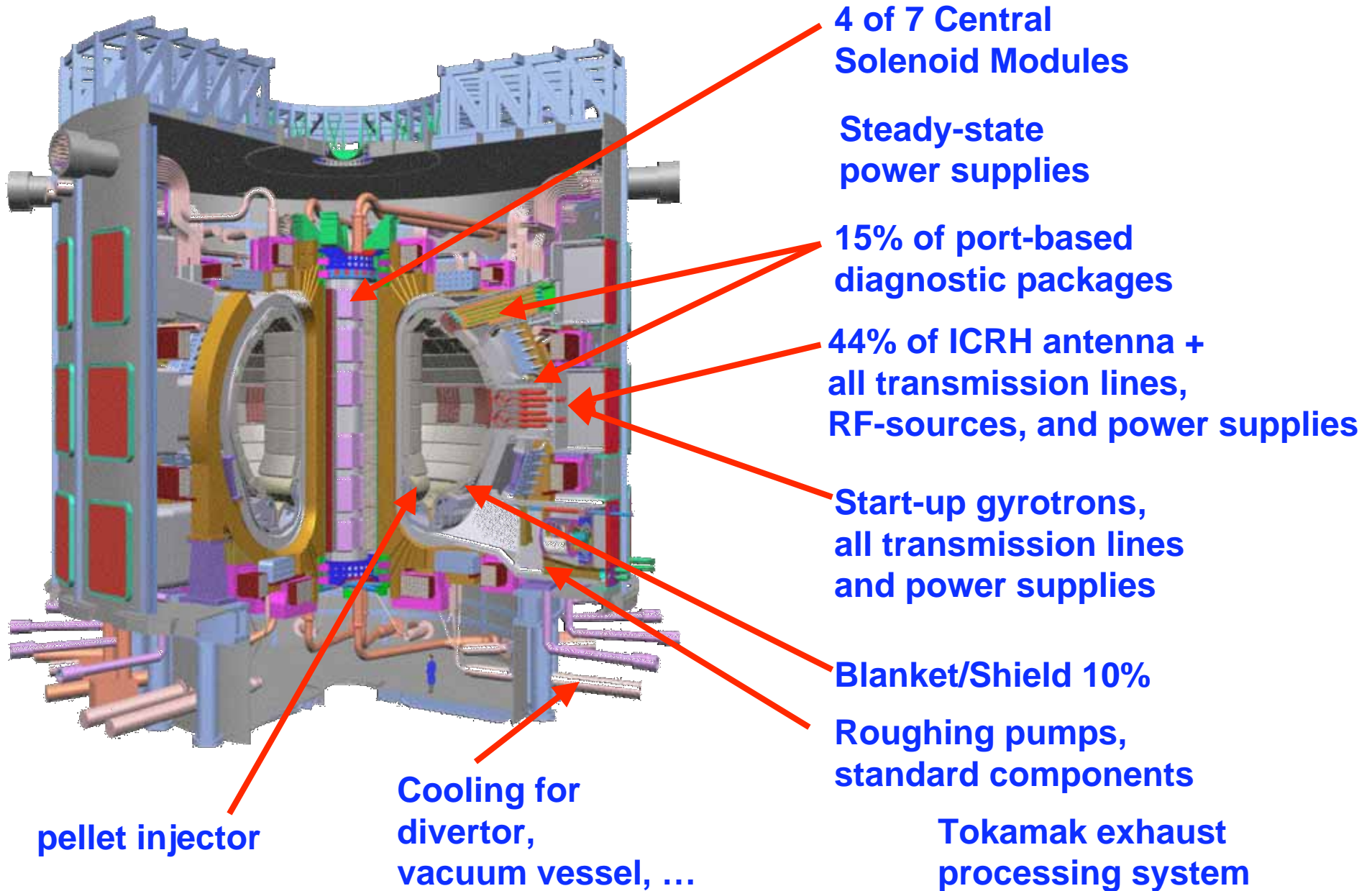

## Alternative U.S. “in-kind contribution” scope

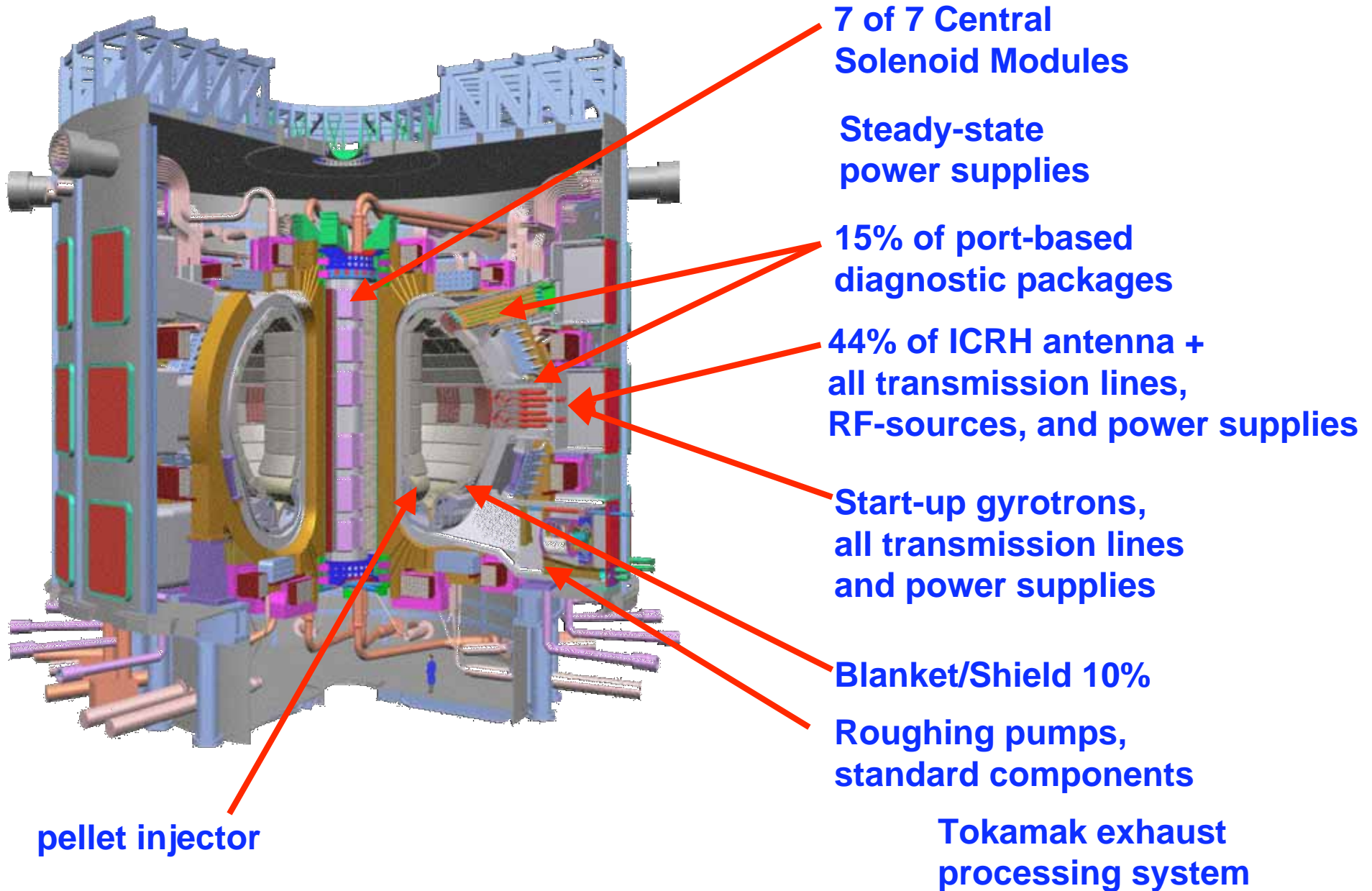

## Working the technical issues

---

- **Magnets: strand, jacket material, integrated design (secondaries and domestic)**
- **Shield/Blanket: analyses and re-design for disruption survival (secondaries and domestic)**
- **ICH: integrated design with EU (secondaries and domestic)**
- **ECH: little work**
- **Tritium processing: integrated design with EU (domestic, working group)**
- **Diagnostics: port-plug engineering (secondaries and domestic)**
- **Vacuum/fueling: R&D on injector (domestic)**
- **Design integration: tools and systems (domestic)**
- **Safety, codes and standards (secondaries and domestic)**

# Qualification of industrial suppliers of Nb<sub>3</sub>Sn strands with increased value of $J_c$

---

- In FY04, the US placed contracts for the development and qualification of >100kg of superconducting strand Products are due in May 2005
- In FY05, the products will be tested.
- In FY06, larger-volume prototypes will be procured.

Initial production orders could be placed IFF the IT's specifications are finalized and the procurement packaged agreed.

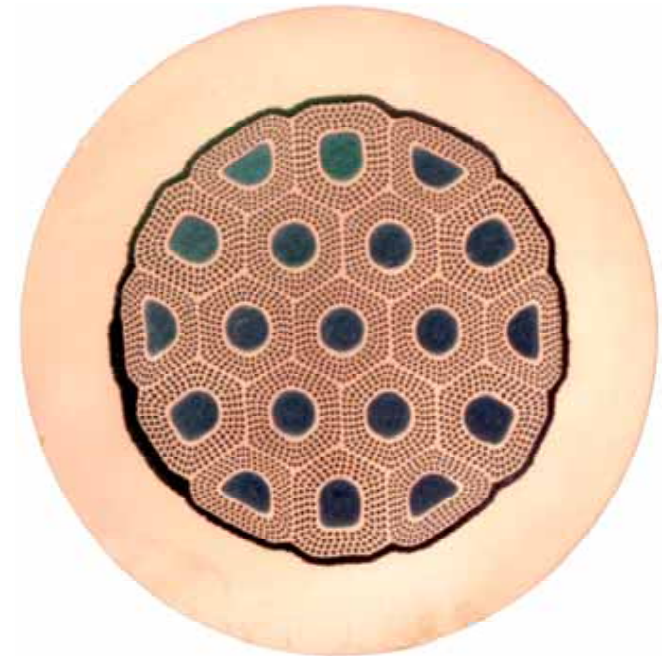

Typical strand layout as proposed by OST. Diameter is ~0.8 mm.

## Mitigating the CS Magnet Technical Risks

<u>Risks/Issues</u>	<u>Tasks and Secondee Assignments</u>
Strand performance and supply	✓ Qualification of industrial suppliers of Nb <sub>3</sub> Sn strands with increased J <sub>c</sub>
Conductor performance and temperature margin	✓ Conductor performance and design criteria (transverse load effects)
Fatigue life of Conductor Jacket	✓ Jacket Materials characterization ✓ CS jacket weld defect assessment
Butt-joints	✓ Joint Development and Tests (butt-type and lap-type)
Integrated performance of the CS	✓ Mechanical Characterization of CS modules, pre-compression structure and support structure
Incomplete CS design and procurement specifications	✓ Secondees: Completion of CS Specifications and Procurement Package
Stresses in the high-field regions of CS Modules	✓ Stress analysis of the helium inlet regions

✓ Indicates an approved task or secondee-assignment; ✓ indicates new task



## Specific shield / blanket tasks

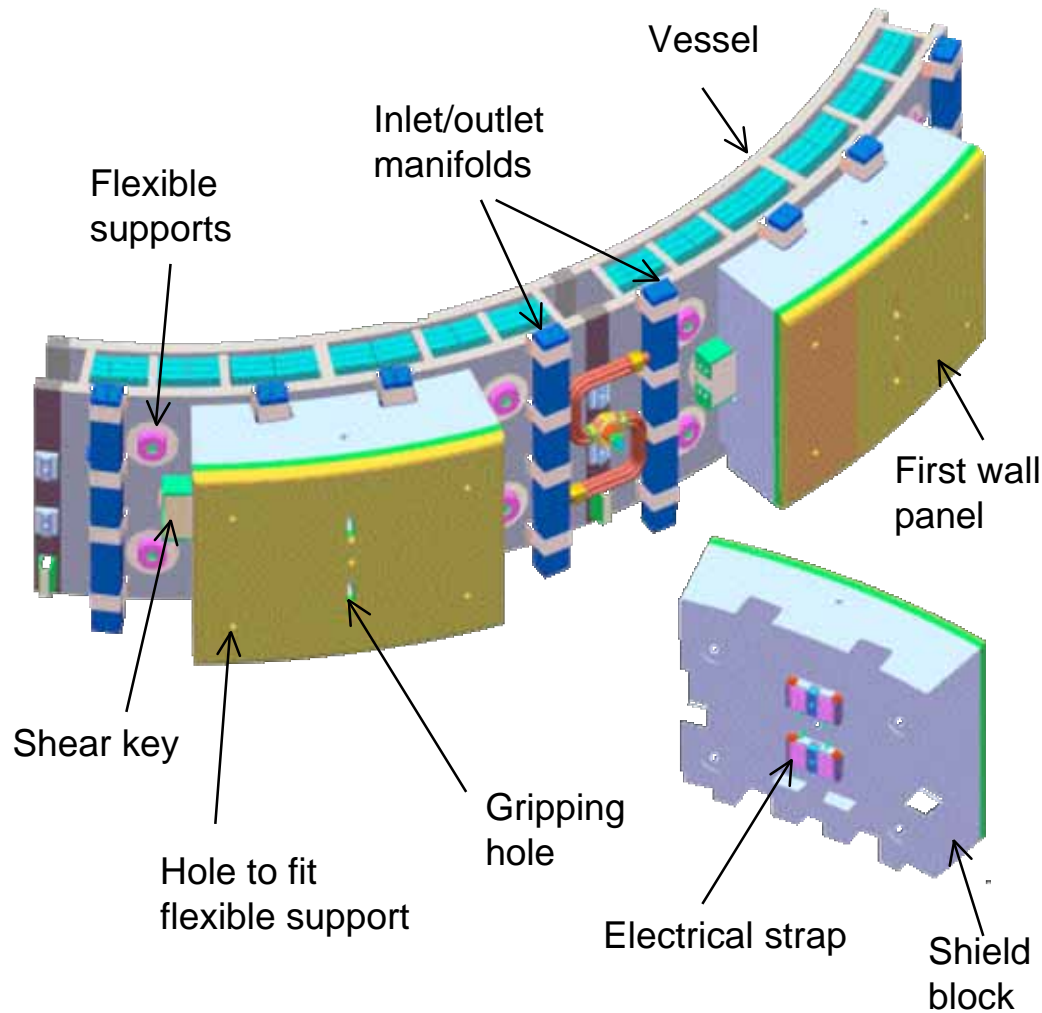

- Qualification of the FW panel fabrication methods and to establish the NDT method for the FW panel.
- EM Analysis of modules and dynamic analysis of the key.
- Detailed design of blanket modules and thermal hydraulic analysis of the shield block and the total blanket system.
- Development of the welded joint for the first wall leg, suited for cut and re-welding in the Hot Cell
- Analysis of erosion of the ITER first wall due to plasma impingement
- **Secondees: Richard Nygren (Sandia), Tom Lutz (Sandia)**

# Some US-assigned Diagnostics (16% of total diagnostics)

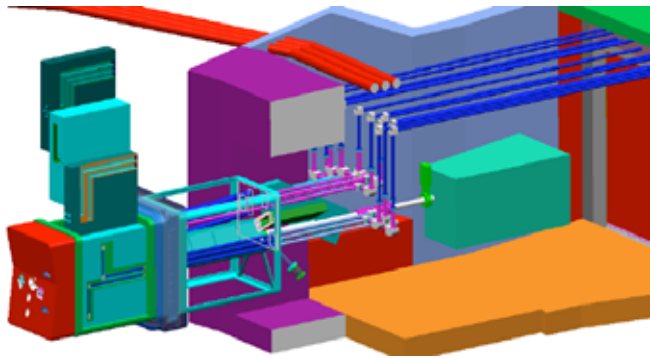

Reflectometer (main plasma – LFS)

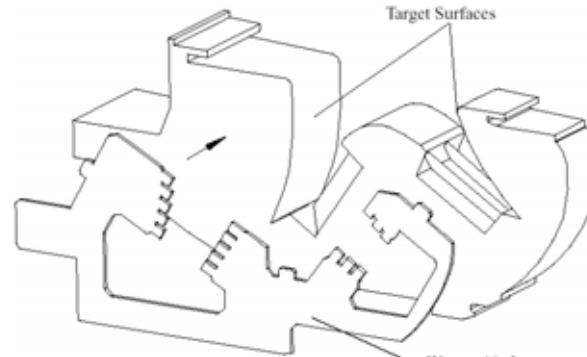

Interferometer (divertor)

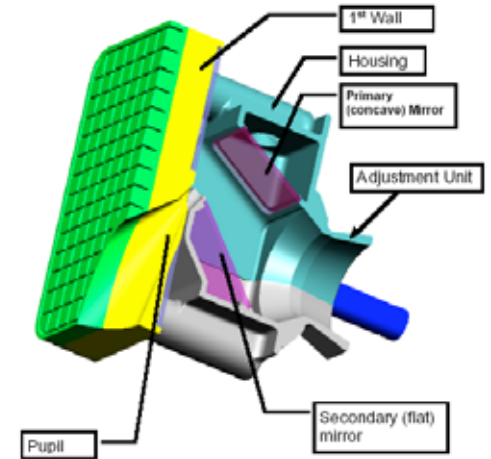

Visible/IR Cameras (upper)

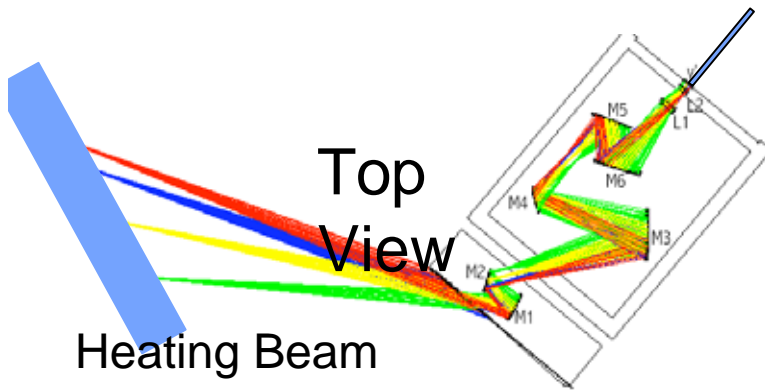

Motional Stark Effect

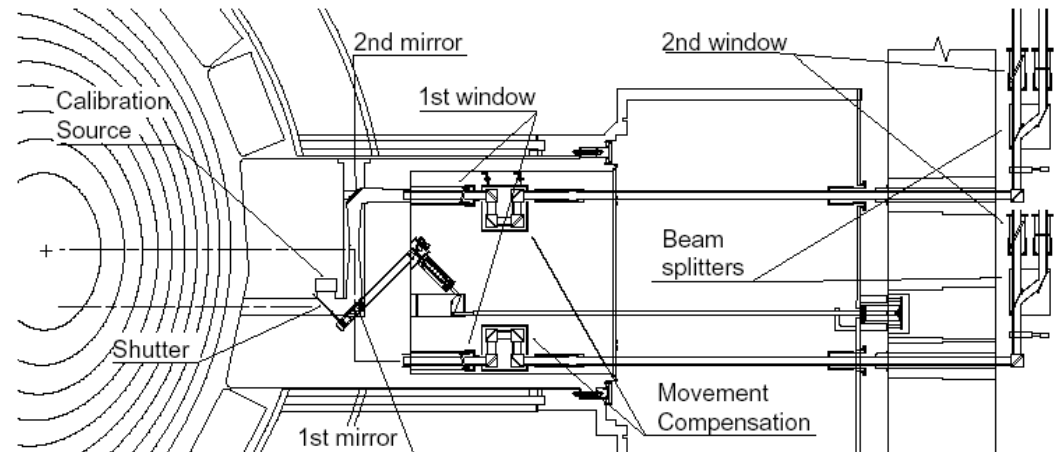

Electron Cyclotron Emission

# Diagnostics Activities

---

- **Diagnostic Working Group**
  - Completed its recommendation on packaging of diagnostic allocations
  - Port-based allocation was accepted by the International Team/Participant Team Leaders
- **Port-Plug Task Force**
  - Developing approaches to the design and integration of port-plugs
- **Diagnostic Design**
  - Specifications of the diagnostics
  - Integrated design of the instruments
  - Component selection
  - Integration in the Port-Plug

## Physics Task Status (1 of 3)

---

- **VDE, Disruptions and their mitigation in ITER.**  
**Model development of halo current width during VDEs based on experiments (GA, M. Sugihara)**  
**Simulations of VDEs in ITER with 3D MHD code (PPPL, M. Sugihara).**  
**Disruption mitigation by noble gas injection (GA, MIT, M. Sugihara).**
  - US PT PIs: David Humphreys (GA); Dennis Whyte (UW/GA/MIT); Bob Granetz (MIT)
  
- **Evaluation of Fast Particle Confinement of ITER (PPPL, V. Mukhovatov).**  
**Evaluation of the effect of fishbone oscillations, TAE modes and toroidal ripple on the fast particle loss**
  - US PT PI: Nikolai Gorelenkov et al (PPPL) [task will be done in two phases: short and long term]

## Physics Task Status (2 of 3)

---

- **Assess the effects of radiation transfer on the ITER divertor solution**
  - US PT PIs: Bruce Lipschultz (MIT)/Steve Lisgo (U. Toronto)
- **Assess the physics in current codes to properly predict the effects of opacity and radiation transfer on divertor plasma solutions for ITER**
  - US PT PIs: Bruce Lipschultz (MIT)/Steve Lisgo (U. Toronto)
- **Benchmarking of ICRF codes on ITER plasma and antenna**
  - US PT PIs: Fred Jaeger (ORNL)/Paul Bonoli (MIT)

## Physics Task Status (3 of 3)

---

- **RWM control in ITER Steady State Scenarios.**  
(Benchmarking of codes used for simulation of RWM feedback control on ITER scenario 4 plasmas. Study of ITER RWM control with in-vessel coils....
  - US PT PI: Jerry Navratil

# NSO - Applying FIRE-Like RWM Feedback Coils to ITER Increases $\beta$ -limit for $n = 1$ from $\beta_N = 2.5$ to 4.9



G. Navratil, J. Bialek Columbia University

## RWM Coil Concept for ITER

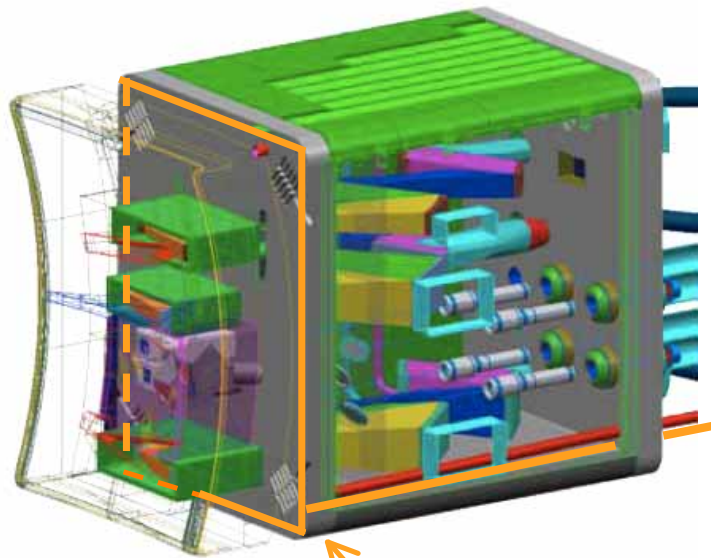

- Baseline RWM coils located outside TF coils
- FIRE-like RWM coils would be located on port shield plugs inside the vacuum vessel.
- Integration and Engineering feasibility of internal RWM coils is under study.

VALEN Analysis Columbia University

Data from "ITER.09.2003"

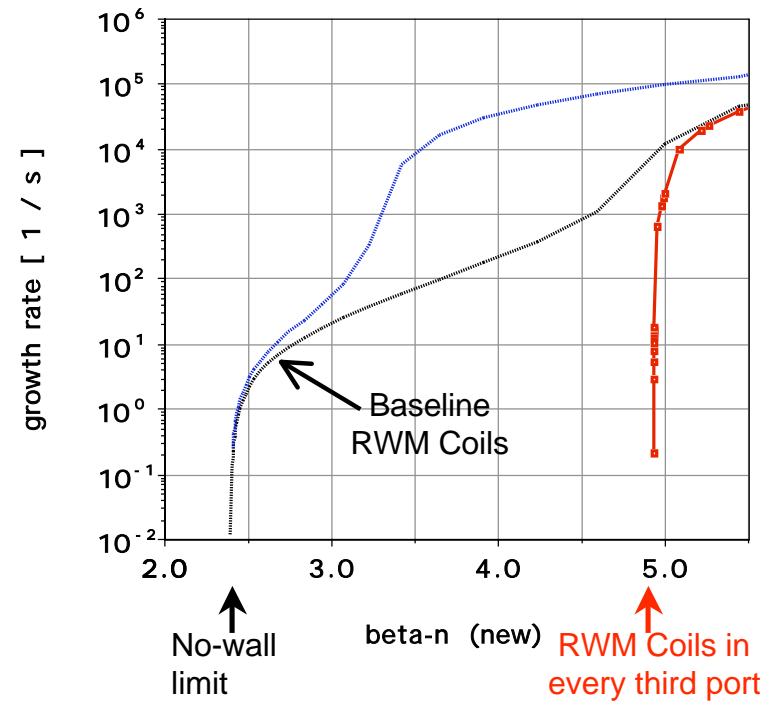

**FIRE-like RWM coils would have large stabilizing effect on  $n=1$**

# The U.S. Burning Plasma Program and the US ITER Project

---

- **The primary goal of US participation in ITER is the performance of research on the science and technology of sustained burning plasmas**
- **US burning plasma research should address both:**
  - Support of the ITER design
  - Advancement of opportunities for enhancement of ITER for research
- **ITER program activities should be conducted as a key part of an integrated US burning plasma research program**
  - Focused on burning plasma issues involving existing facilities, future facilities (ITER), theory, simulation, diagnostic R&D, and enabling technology
  - Coupled with topical groups
  - Engaging interested US participants in a wide range of roles
  - Working within the international community
  - Linked to the international and domestic project activity



# Outline: Key Topics in this Preparatory Phase

---

- **Technical Activities**

- Addressing risk in the US in-kind contributions and enhancing ITER's research capabilities

- **Project Management**

- Increasing effectiveness during the ITER Transitional Arrangements (International Team/Participant Team Leaders meeting 2/05)
- FY06 budget scenarios
- DOE/SC Review 3/22-24/05

## IT/PT Leaders' Meeting 2/05

---

- **ideas for improved integrated effectiveness of the combined ITER teams during the ITER Transitional Arrangements**
  - more focus on teamwork and coordination of R&D and design tasks
    - Joint development of the design issues and approaches to resolution, leading to decision-packages for the Director General
  - strengthening the International Team staff
    - 64 secondees, 10 visiting researchers, and 7 part timers
    - totals: CN 5, EU 33, JA 25, KO 0, RF 13, and US 5
  - restoring a technical advisory committee
- **positioning for start of construction**
  - visualizing the procurement approaches, especially for shared packages

# US Secondees

---

- **Magnets:**
  - Nicolai Martovetsky (LLNL), Philip Michael (MIT)
- **Blanket/First Wall:**
  - Richard Nygren (Sandia), Tom Lutz (Sandia)
- **Ion Cyclotron:**
  - David Swain (ORNL), Richard Goulding (ORNL)
- **Diagnostic Port Plug Design:**
  - Douglas Loesser (PPPL)
- **QA [Head of QA on the ITER International Team]:**
  - W. K. Sowder (INL)

# US Participation in ITER Working Groups

---

- **Magnet working groups**
  - CS Specification Committee: Timothy Antaya (MIT)
  - TF Structure Specification Committee: Peter Titus (MIT)
  - PF Insert Test Committee: Nicolai Martovetsky(LLNL)
- **Diagnostic Port-Plug Task Force (following Diagnostic Working Group)**
  - Réjean Boivin (GA)
  - Mike Cole (ORNL)
  - Steve Allen, Douglas Dobie (LLNL)
- **Tritium Plant Integration Group**
  - Scott Willms (LANL)
- **Materials Properties Handbook special working group**
  - Arthur Rowcliffe, Steve Zinkle (ORNL)
- **Test Blanket Working Group**
  - Mohamed Abdou (UCLA)
  - Dai-Kai Sze (UCSD)
  - Michael Ulrickson (SANDIA)

# Outline: Key Topics in this Preparatory Phase

---

- **Technical Activities**

- Addressing risk in the US in-kind contributions and enhancing ITER's research capabilities

- **Project Management**

- Increasing effectiveness during the ITER Transitional Arrangements (International Team/Participant Team Leaders meeting 2/05)

- FY06 budget scenarios

- DOE/SC Review 3/22-24/05

## The President's Budget (\$M)

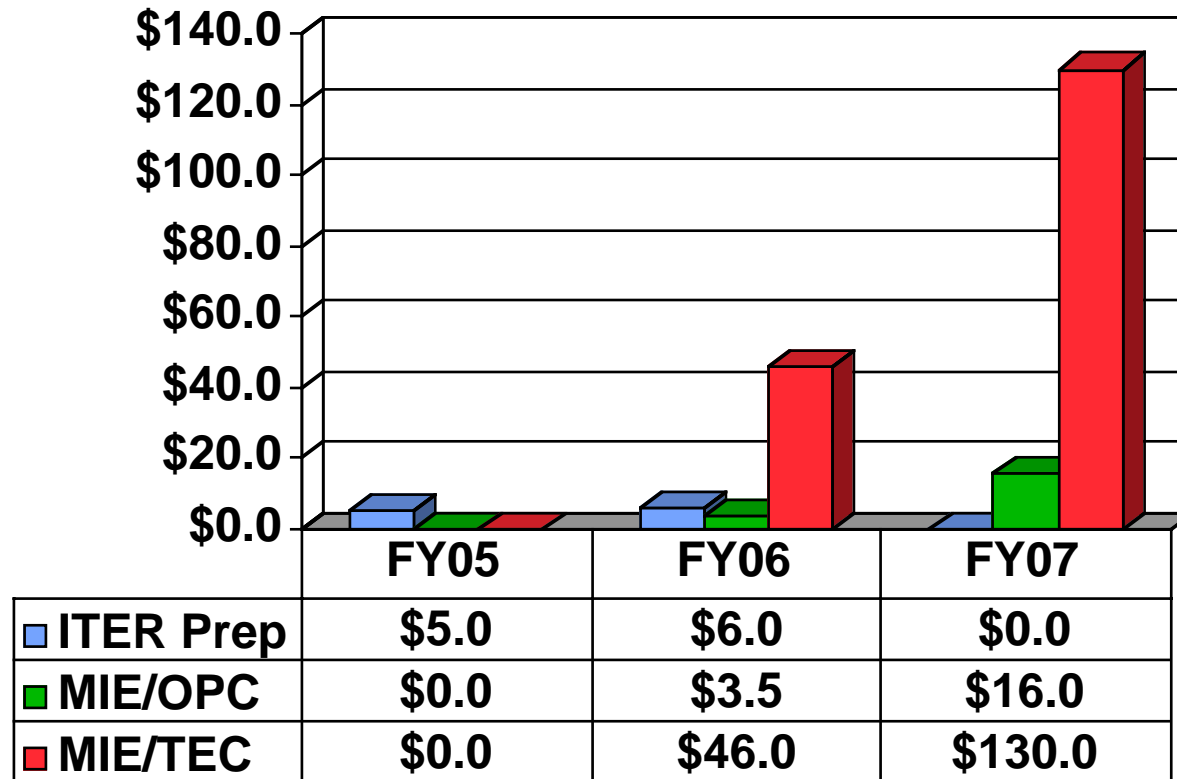

- **ITER Prep: Operating funds to prepare for the US ITER project**
- **MIE/OPC: “Other Project Costs”**
  - Operating funds to cover Research
- **MIE/TEC: “Total Estimated Cost”**
  - Equipment funds for Design, Fabrication, and Delivery

## **The President's Budget Request is based on an optimistic schedule of international agreement**

---

- **If the ITER site decision were early and senior-management engagement were quick, then procurement of some long-lead components/materials could be compatible with FY06. Consider the following scenario:**
  - April 2005: Site decision in April 2005, along with a path to DG selection
  - July 2005: DG and some DDGs begin working with the International Team and parties provide staff to address technical issues and work toward decisions
  - October 1, 2005: Parties initial International Agreement, which is provided for second Circular 175 and to Congress for review
  - February 2006: 120-day Congressional review of the International Agreement completed
  - May 2006: Technical reviews of ITER, leading to specifications for long-lead procurements
  - June 2006: US receives proposed procurement agreements for long-lead procurements from the ITER team
  - July 2006: US initiates procurement of long-lead materials, such as superconducting strand
- **However... If the site decision and/or senior management engagement were delayed, construction scope would slip beyond FY06; BUT R&D and design activity would still be needed in FY06**

## FY06 priorities

---

- **To prepare for ITER procurements:**
  - Need to perform manufacturing R&D especially on conductor for superconducting magnet.
  - Need to perform final design specifications for U.S. procurements.
  - Need to prepare procurement packages for bid.
  - Need to contribute team members to international ITER Organization to coordinate R&D and design and to oversee procurement preparations.
- **To initiate procurements of long-lead-time components  
IFF the international project has finalized the specifications  
AND other parties are positioned to engage in the critical-path activity  
AND the associated budget does not damage the US program**



## Uncertainty in the international schedule motivates consideration of a range of FY06 ITER budgets (\$M)

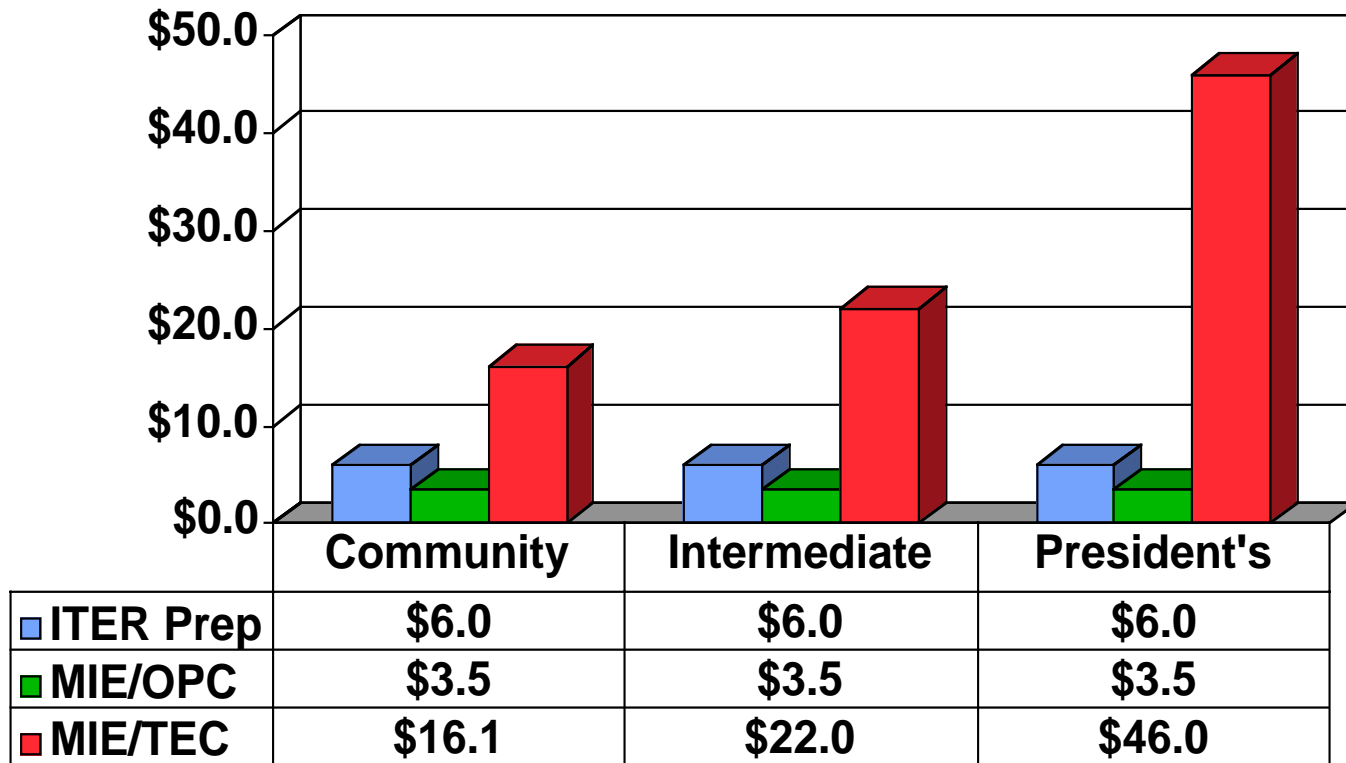

- “ITER Prep” supports preparation early in FY06 (same in all cases)
- “MIE/OPC” supports Research for the last third of FY06, sustaining level “VLT-staff” support of ITER (same in all cases)
- “MIE/TEC” supports more intensive design, prototyping, and procurement of long-lead materials (only in “President’s”) aiming at readiness to start construction in 2007

# Magnitudes of FY06 budgets (\$M) in major areas of contribution

**Staff for  
the ITER  
Organization**

**In-kind contributions  
(R&D, design, fabrication,  
oversight, and delivery)**

**Cash to  
the ITER  
Organization**

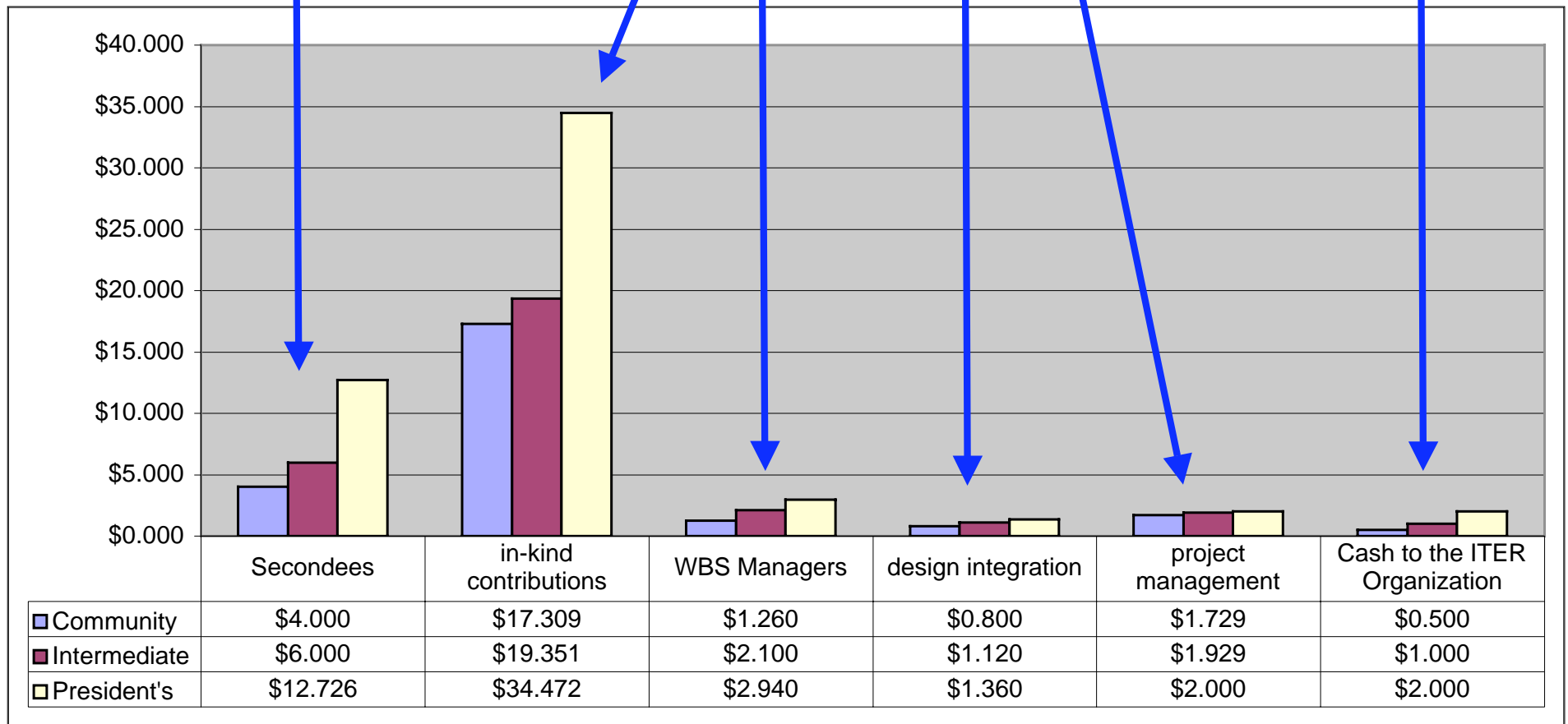

# in-kind contributions (\$M)

- **FY06 in-kind-contribution work focuses on preparations for fabrication of US components**
- **The President's budget permits start of procurement of long-lead materials**

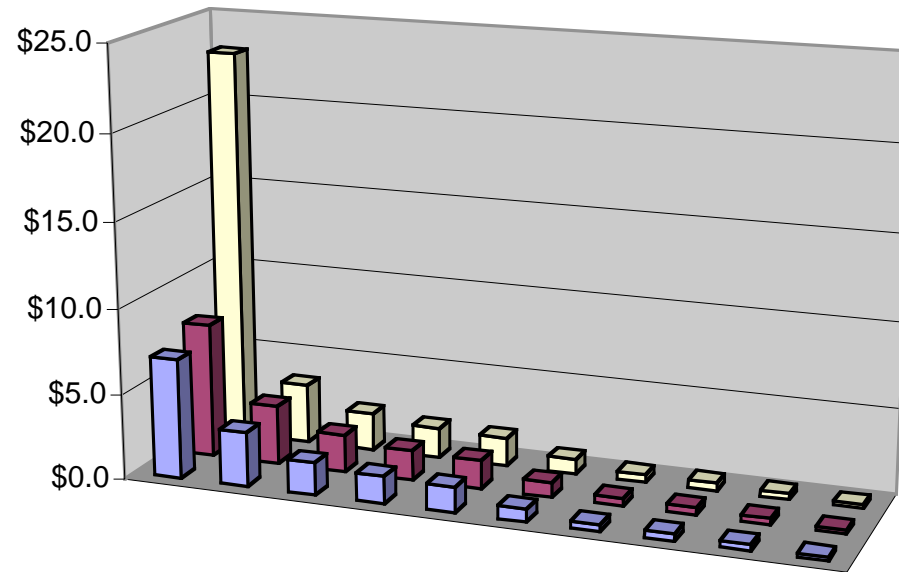
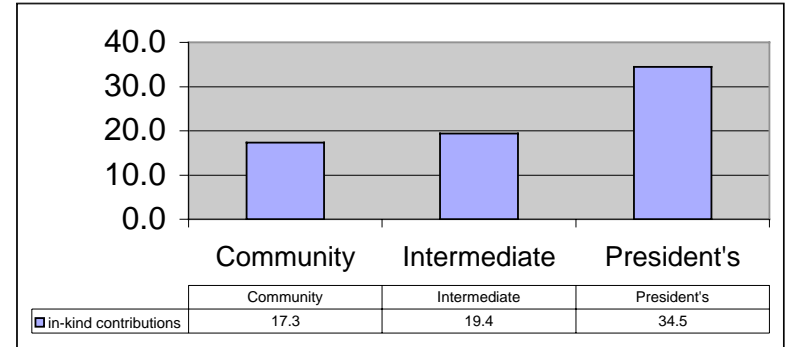

	magnet	blanket/ shield/ PFC	diagnostics	ECH	ICH	Tritium	cooling water	steady state power	vacuum/ fueling	safety
Community	\$7.0	\$3.2	\$1.9	\$1.6	\$1.5	\$0.8	\$0.4	\$0.4	\$0.4	\$0.2
Intermediate	\$7.9	\$3.5	\$2.2	\$1.8	\$1.7	\$0.9	\$0.5	\$0.5	\$0.4	\$0.2
President's	\$23.0	\$3.5	\$2.2	\$1.8	\$1.7	\$0.9	\$0.5	\$0.5	\$0.4	\$0.2

## Institutional: Distributions among performers: US fusion community, industry, and ITER Org (\$M)

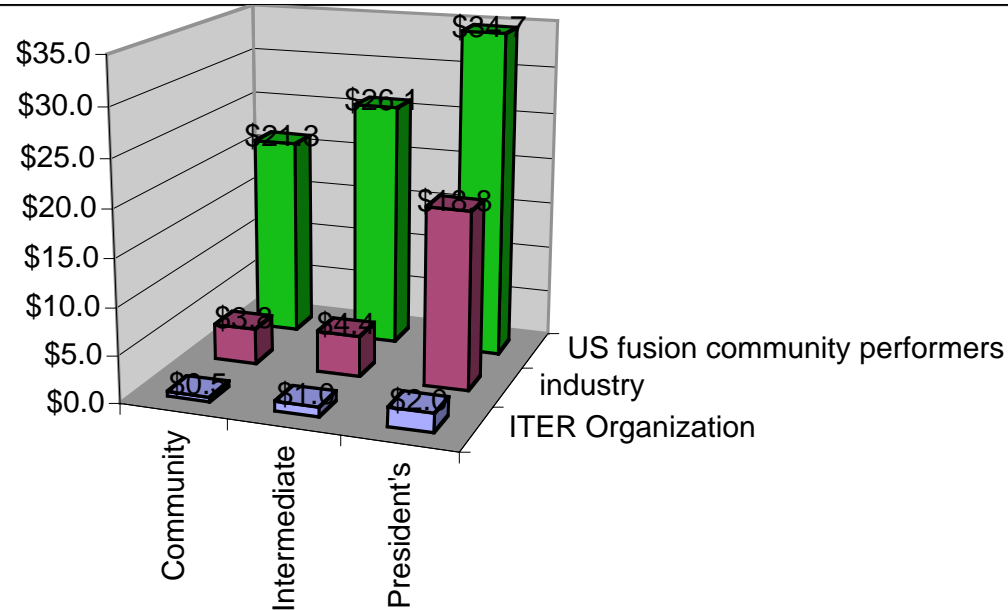

	Community	Intermediate	President's
■ ITER Organization	\$0.5	\$1.0	\$2.0
■ industry	\$3.8	\$4.4	\$18.8
■ US fusion community performers	\$21.3	\$26.1	\$34.7

- Fusion community performers (including secondees) receive the majority of the resources in all 3 FY06 cases (\$21M, \$26M, and \$35M)
- Industry receives a major fraction only in “President’s case”
- Cash for the ITER Organization is small in all cases

**How would the fusion community be engaged  
in community-scopes totaling ~\$21M-\$34M in FY06?**

<b>Magnet design</b>	<b>~\$3.5M</b>
<b>Blanket/shield design</b>	<b>~\$3M</b>
<b>Diagnostic design (instruments + plugs)</b>	<b>~\$2M</b>
<b>Electron cyclotron design</b>	<b>~\$1.5M</b>
<b>Ion cyclotron design</b>	<b>~\$1.5M</b>
<b>Tritium processing design</b>	<b>~\$0.8M</b>
<b>Vacuum/fuelling design</b>	<b>~\$0.3M</b>
<b>Cooling water design</b>	<b>~\$0.3M</b>
<b>Steady-State Electric Power</b>	<b>~\$0.3M</b>
<b>Safety</b>	<b>~\$0.2M</b>
<b>Secondaries</b>	<b>~\$4-13M</b>
<b>Design Integration</b>	<b>~\$1M</b>
<b>WBS managers</b>	<b>~\$1-3M</b>
<b>Project management</b>	<b>~\$2M</b>

# US ITER Project Advisory Committee will be addressing the approaches to team-building

---

- **Harold Forsen (Chair)**
- **Project Management / Procurement Folks:**
  - Jay Marx (LBNL)
  - Jim Yeck (U Wisconsin)
  - Robert Iotti (CH2M-Hill)
  - Eugene Desaulniers (consultant)
- **Universities:**
  - Stewart Prager (U Wisc)
  - Jerry Navratil (Columbia)
  - Neville Luhmann (UC Davis)
  - Herb Berk (UTexas)
- **Major Facilities / Labs:**
  - Earl Marmor (MIT)
  - Ron Stambaugh (GA) [invited]
  - Mike Zarnstorff (PPPL)
  - Lee Berry (ORNL)
  - Dave Hill (LLNL)
  - Kathy McCarthy (INEEL)

# Outline: Key Topics in this Preparatory Phase

---

- **Technical Activities**

- Addressing risk in the US in-kind contributions and enhancing ITER's research capabilities

- **Project Management**

- Increasing effectiveness during the ITER Transitional Arrangements (International Team/Participant Team Leaders meeting 2/05)

- FY06 budget scenarios

- DOE/SC Review 3/22-24/05

## Project Completion Criteria

U.S. Contributions	Completion Criteria
In-kind contributions ~270,000 ITER Units of Account	Acceptance of in-kind contributions by the ITER Organization  Delivery to ITER Organization with arrangement for remaining assembly (if any)
Cash contribution for installation and common expenses ~32,000 ITER Units of Account	Arrangement for completion of cash contribution, bringing total of in-kind and cash contributions to 302,000 IUA
Staff contribution  180 professional person years (84 at ITER site, 96 in Field Teams)  276 support person years (84 at ITER site, 192 in Field Teams)	Arrangement for completion of supply of staff



**U.S. Critical Decision schedule  
from revised Mission Need (February 2005)  
and Federal Project Director**

<b>CD-0 Approve Mission Need</b>	<b>2nd Q FY 2005 (March 2005)</b>
<b>CD-1 Approve Alternate Selection and Cost Range</b>	<b>2nd or 3rd Q FY 2005 (June 2005)</b>
<b>CD-2 Approve Performance Baseline</b>	<b>1st or 2nd Q FY 2006 (December 2005)</b>
<b>CD-3a Approve Start of Fabrication (long lead components)</b>	<b>3rd or 4th Q FY 2006 (June 2006)</b>
<b>CD-3b Approve Start of Fabrication (remaining components)</b>	<b>TBD* (June 2007)</b>
<b>CD-4 Project Completion</b>	<b>4th Q FY 2013 (September 2013)</b>

\* Note: Pending international schedule

## Cost Baseline Range

---

Minimum TPC	Feb 2005 Estimated TPC	Maximum TPC
\$1115M	\$1184M 22.9% contingency*	\$1291M 30% contingency*

\*Percentage based on all scope other than “Support to the International Team” (\$189M), which has no contingency in the Estimated TPC because of the scope being specific cash and staff-years

# Bottom Lines

---

- **The US is addressing risk in the US in-kind contributions and enhancing ITER's research capabilities**
  - We are completing technology R&D, prototyping, designing, and planning for industrial involvement.
  - We look forward to working with the community and DOE in the U.S. Burning Plasma Program, addressing physics design issues and positioning for research.
- **The US is working toward increased effectiveness of the combined ITER Team**
  - We are arranging ITER tasks in both physics and technology.
  - We are developing recommendations on international and domestic project management.
- **The FY06 US ITER scope and budget depend on the international schedule**
  - With rapid site selection, team-building, and decision-making, procurement of long-lead components could be procured in FY06.
  - With slower progress, procurements and full US participation on the team will be delayed.
- **The DOE/SC Review 3/22-24 focused on project plans and the cost range**
  - We will improve the plans and cost range estimate based on recommendations.
  - We will work toward CD-2, but achievement of CD-2 will require international progress.