

Report of the Toroidal Alternates Panel

David N. Hill (Panel Chair)

Lawrence Livermore National Laboratory

Outline

- Charge from Under Secretary of Science
- Panel membership and process
- Panel findings: answers to the charge
 - General findings
 - Concept specific:
 - ITER-era goals
 - High-priority issues, gaps, and initiatives
 - Scientific benefits
- Website: <http://fusion.gat.com/tap>

Presented to FESAC: November 6, 2008



Charge to FESAC From DoE Under Secretary for Science

- **Focus on Four Toroidal Confinement Concepts**
 - Spherical Torus, Stellarator, Reversed-Field Pinch, Compact Torus(FRC & spheromak)
- **For those concepts that are seen to have promise for fusion energy, please identify and justify a long-term objective for each concept as a goal for the ITER era.**
 - ITER era: when ITER operates (~ next 15-20 years)
 - Panel addressed all four
 - Iterative process with community to identify ITER-era goal
 - Reasonably ambitious and focused goals
- **With that[goal] in mind, I ask that FESAC:**
 - 1 critically evaluate the goal chosen for each concept, and its merits for fusion development;
 - 2 identify and prioritize scientific and technical questions that need to be answered to achieve the specified goal;
 - 3 assess available means to address these questions; and
 - 4 identify research gaps and how they may be addressed through existing or new facilities, theory and modeling/computation.
- **Identify and prioritize the unique toroidal fusion science and technology issues that an alternate concept can address, independent of its potential as a fusion energy concept.**

Panel Members Represent a Broad Cross Section of Experts From the Fusion Community

FESAC Toroidal Alternates Panel

David Anderson	University of Wisconsin	dtanders@facstaff.wisc.edu
Jeff Freidberg	MIT	jpfreid@mit.edu
Martin Greenwald	MIT	g@psfc.mit.edu
Houyang Guo	RPPL @ U. Washington	guo@rppl.aa.washington.edu
Rich Hazeltine (VC)	U. Texas	rdh@physics.utexas.edu
Dave Hill (Chair)	LLNL	hilldn@fusion.gat.com
Bick Hooper	LLNL	hooper1@llnl.gov
Hantao Ji	PPPL	hji@pppl.gov
Tim Luce	General Atomics	luce@fusion.gat.com
Dale Meade	FIRE	dmeade@pppl.gov
Jon Menard	PPPL	jmenard@pppl.gov
Martin Peng	ORNL	pengym@ornl.gov
John Sarff	U. Wisconsin	jssarff@facstaff.wisc.edu
John Sheffield	ISSE @ U. Tennessee	jsheff1@utk.edu
Xianzhu Tang	LANL	xtang@lanl.gov
Ed Thomas	Auburn U.	etjr@physics.auburn.edu
Mike Zarnstorff	PPPL	zarnstorff@pppl.gov

- Universities, Labs, and Industry
- Experiment and theory
- 8 Concept Experts
9 At-large members
6 FESAC members
- Panel members bring
 - Recognized contributions to fusion science
 - Program management experience
 - Experience on similar panels

Panel Organization and Process

- Panel organized into four Concept Working Groups to lead technical analysis: Stellarator, ST, RFP, and CT
- Panel meetings and interactions
 - Bi-weekly teleconference through mid-September
 - Weekly teleconference since mid-September
 - Working group teleconferences as needed
 - Website and email interaction
 - Three face-to-face panel meetings
 1. June 30-July 2 @ DFW: community input, methodology, concept goals
 2. August 5-7 @ Gaithersburg: goal evaluation, issue prioritization, report structure
 3. October 1-2 @ Austin: issues, facilities, gaps, findings and recommendations, report editing

Community Input

- **Panel sought advice from the broader fusion community**
 - Website provided opportunity for open input (only filtered for spam)
 - Invitation to participate sent to USBPO, UFA, ICC, FPA, and experiments
 - Invited 15 page submissions by concept advocates and researchers
 - Maintained an interactive process (not an exam): Q&A from panel to community
- **ITER-era goals provided by concept advocates with panel feedback**
- **Concept presentations to the Panel (6/30–7/2 @ DFW Wyndham)**
 - Invited speakers addressed questions sent from panel working groups
 - 2 hr blocks for each concept (60min presentation, 60min discussion)
 - 1 hr for brief public comments each day by request
 - Presentations were open to the public (23 external participants)

[View all input at <http://fusion.gat.com/tap/community>](http://fusion.gat.com/tap/community)

Research on Toroidal Alternates Seeks to Reduce the Size, Cost and Complexity of the Fusion Power Core

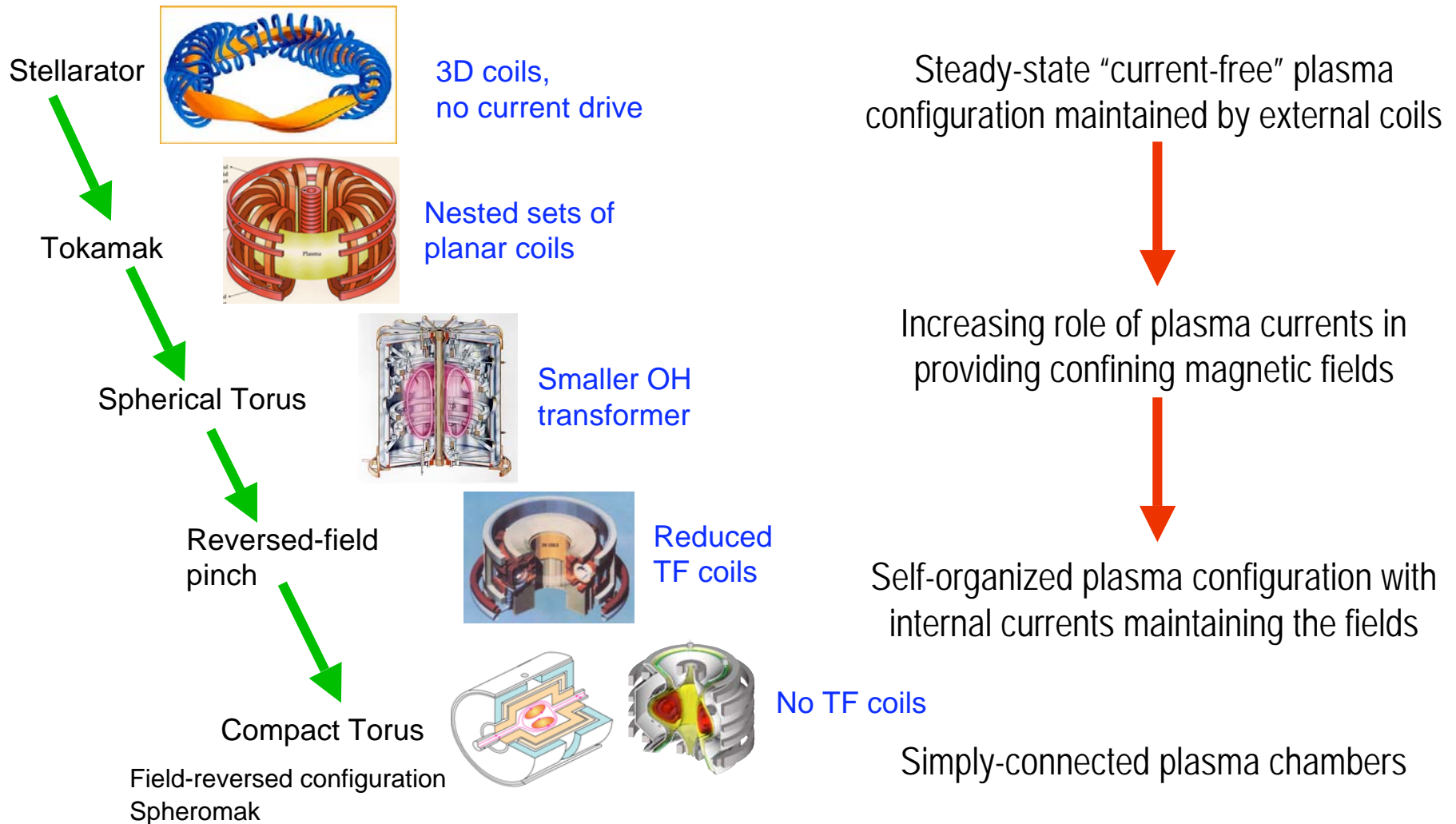

The Four Toroidal Magnetic Confinement Alternates

Stellarator

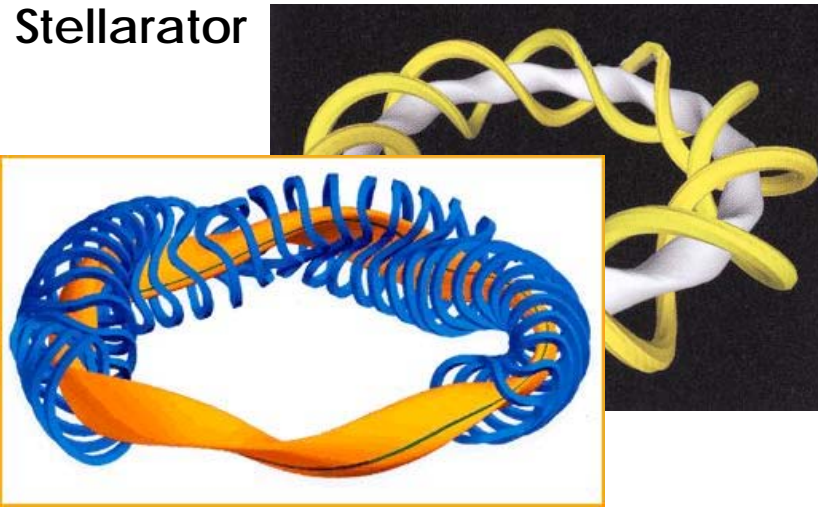

Spherical Torus (ST)

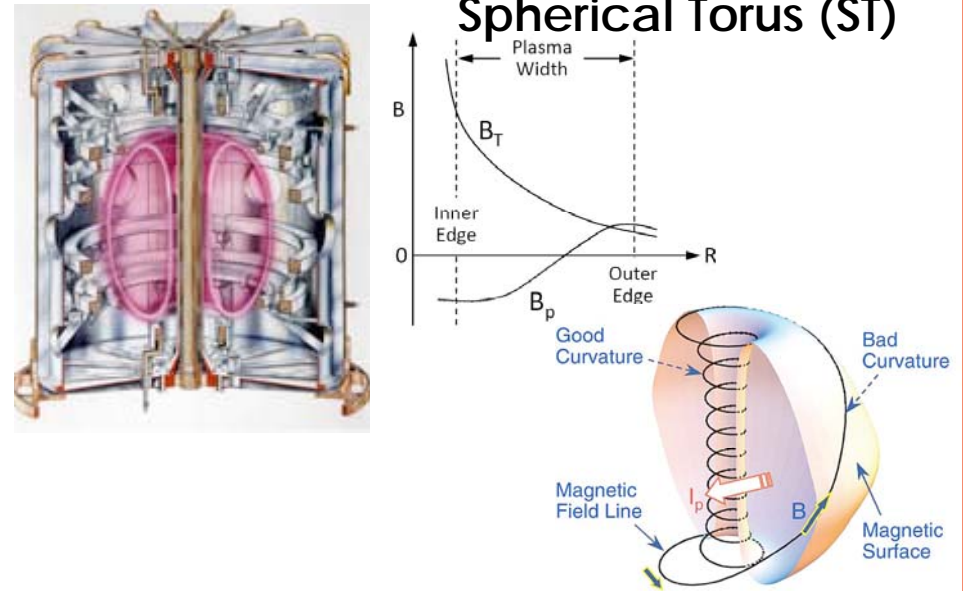

Compact Torus (CT)

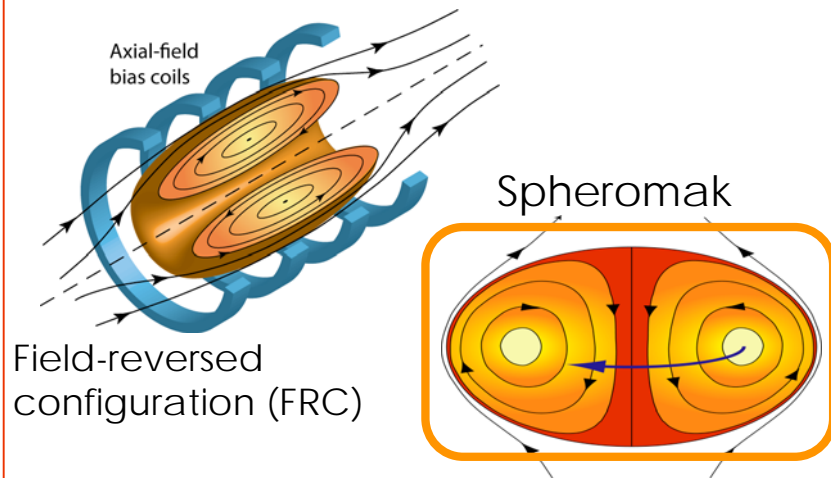

Reversed-field Pinch (RFP)

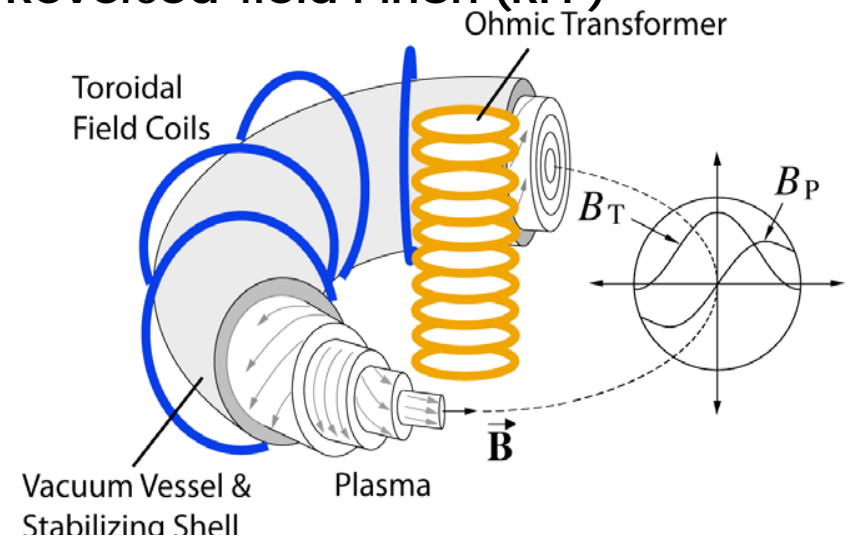

All Approaches to Magnetic Confinement Must Satisfy Lawson Criteria: Some Are Closer Than Others

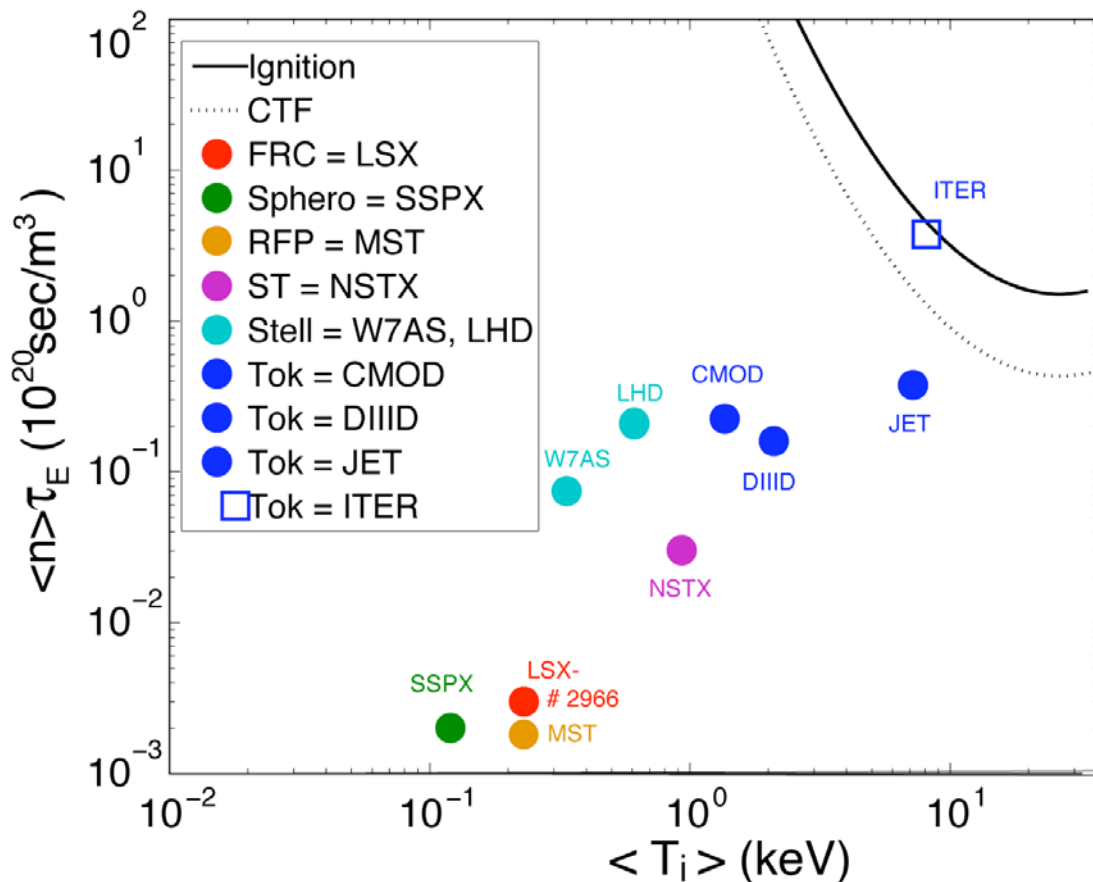

Must overcome transport and Bremsstrahlung losses for ignition
 $nkT \tau_E > 8.3 \text{ atm-sec}$ at $\langle T_i \rangle = 15 \text{ keV}$

Fusion power density $\propto \beta^2 B^4$

$$\beta = \frac{2\mu_0(nkT)}{B^2}$$

Motivates operation at high field and high β . Also note: $\tau_E \propto B$.

MHD stability limits β

Coil engineering constraints limit B

Performance of Alternate Concepts Relative to Their ITER-era Goals

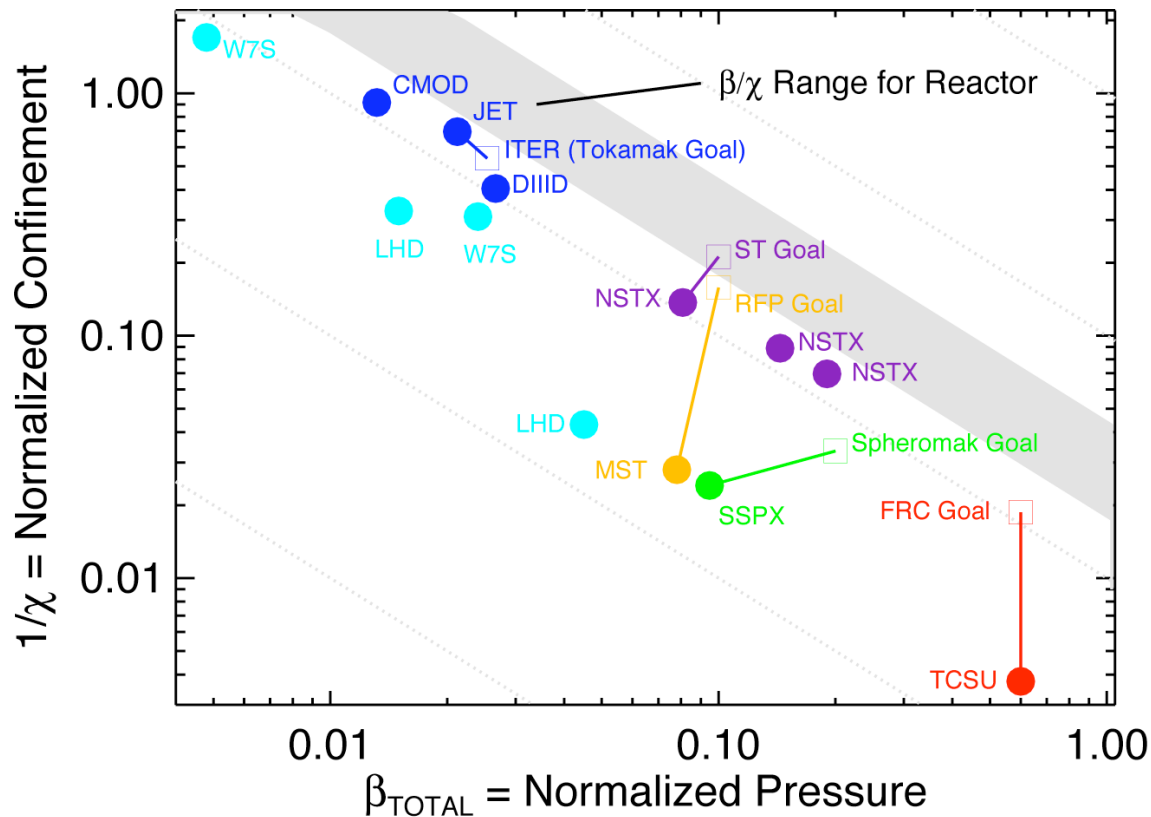

Chart does not distinguish sustained vs. transient results

- Sheffield (NF 25 1733, 1985) considered general requirements for an attractive (COE) MFE reactor.
- Lawson ignition criteria, with 1D transport and neutron wall loading included, yields

$$\frac{\langle \beta \rangle}{\bar{\chi}_E}$$
 as a figure of merit.
- Takes out size, but possibly not B if χ_E is neoclassical or otherwise dropping with field.

General Report Structure and Emphasis

- **Concept by concept evaluation and prioritization**
 - Each concept was evaluated relative to its ITER-era goals, rather than to its ultimate potential reactor advantages, which are well known but may be difficult to achieve in practice
 - Each concept faces significant scientific and technical challenges in meeting its own ITER-era goals
- **ITER-era goals for each concept motivate uniquely prioritized research**

General Findings

1. The overall quality of the science in toroidal alternates research is excellent, with broad benefit to the U.S. fusion program and to general plasma sciences including applications to other disciplines. The work is strongly focused on developing scientific understanding as the path forward to achieving ITER-era goals.
2. Alternate Concepts research provides significant benefit to the broader U.S. fusion and plasma science program by effectively recruiting and training bright young people to be our nation's next generation fusion scientists.
3. Predictive simulation plays a central and increasingly visible role in toroidal alternates research, in many cases pushing the state-of-the-art computational capability.
4. Alternate concept research requires similar tools to other parts of the fusion program, but it has uniquely urgent needs in two areas: (1) theory and simulation, which which are particularly challenged by complex 3D resistive MHD physics, kinetic effects, and anomalous transport seen in these experiments; and (2) diagnostic capability, which is especially vital for the less mature concepts. These areas deserve priority emphasis and support within the alternates program to strengthen scientific contributions and solidify projections to next step experiments.
5. Promise for Fusion Energy: Some of the four concepts we have considered are much more highly developed than others, yet all of them require further development and investigation before any definitive assessment of their fusion energy capabilities is possible.

Clarification of General Finding #4

- In general, we know the least about those concepts requiring the largest extrapolation to reach fusion conditions.
 - All of the magnetic configurations have complex scientific challenges, some similar, some unique
 - Less developed concepts tend to have more limited diagnostics and less theoretical support on critical issues
 - Need for predictive understanding is more acute when there are few or even one-of-a-kind facilities with limited operating parameter range
 - Increased collaborations on diagnostics and theory/modeling might be an efficient means to a larger effort

Evaluating the ITER-era Goals

1. **Importance and relevance: Does the goal address critical scientific and technical issues to advance this concept and fusion science?**
 - a. Will reaching the goal significantly change the outlook for the concept (i.e., address the major issues)?
 - b. Will reaching the goal contribute to the improvement of other concepts?
 - c. Will achieving the scientific goals for this concept significantly advance our knowledge of plasma science?

2. **Technical risk: Are the goals reasonably achievable based upon the current state of knowledge for this concept?**
 - a. What degree of extrapolation in parameters or technical capability does the goal represent?
 - b. Is there a sound scientific basis (theory and/or experiment) to anticipate success?
 - c. To what extent will achieving the goal provide sufficient understanding to advance fusion science?
 - d. Resource requirements: significant, not too big, almost free

Issue Prioritization Criteria

Tier 1

- Issue is **critical** for reaching the agreed upon goal
- Issue contributes in an important way to the viability of the concept as a fusion energy source
- Resolution of this issue requires **major extrapolation** from current state of knowledge
- **Scaling is untested and/or physics uncertain**
- **Progress on this issue is essential** before other research areas can be adequately addressed.
- Progress would have the **broadest impact on fusion** and plasma science

Tier 2

- Issue is **important** for reaching the goal and/or for the viability of the concept as a fusion energy source
- Resolution of this issue requires major extrapolation from current state of knowledge
- Only **limited scaling data and physics basis exist.**
- **Progress on this issue would be helpful** for research on other configurations
- Progress would have a **moderate impact** on fusion science

Tier 3

- Reaching the goal will require **moderate extrapolation** from current state of knowledge
- **Some scaling data and/or a partially validated physics basis are available**
- Information for resolving this issue may come from other parts of the FES program
- Present **status does not hinder progress** on other issues.
- Progress would have a **narrow impact** on fusion science

The Stellarator Uses External coils to Generate the Confining Fields: Steady-state With Little or No Plasma Current

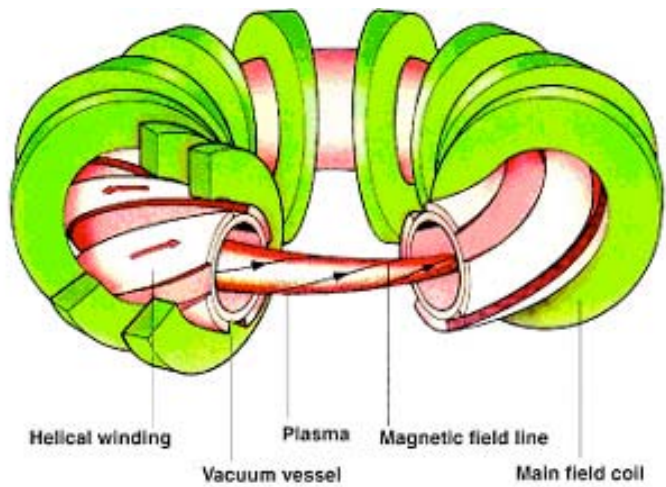

- Rotational transform provided by “helical” windings. No current - no transformer or auxiliary current drive - steady state - no disruptions
- Conventional stellarators have large neoclassical transport due to variation in $|B|$ and significant particle trapping.
- Complex coil geometry, 3D power handling

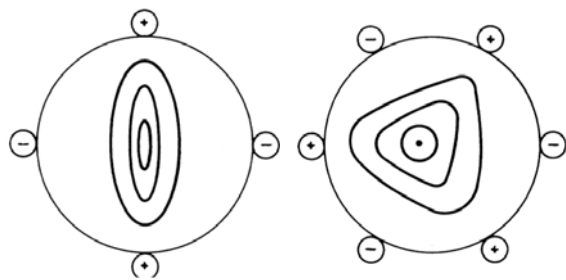

Cross section depends on windings
 $\iota = 2\pi/q$

Modular coils: W7-X (Germany-under construction)



ITER-era Goal for the U.S. Stellarator Research

- Long-range Mission: *To achieve sufficient scientific understanding and plasma conditions to justify designing a fusion reactor based on a fully steady-state, passively stable stellarator.*
- ITER-era goal: *Develop and validate the scientific understanding necessary to assess the feasibility of a burning plasma experiment based on the quasi-symmetric (QS) stellarator.*

This goal focuses on conducting the scientific and engineering research required to write a physics-basis document, similar to the ITER Physics Basis documents published in Nuclear Fusion, which would be necessary to begin construction of a burning plasma experiment based on a quasi-symmetric stellarator. It is anticipated that the LHD, W7-X, and ITER experiments would provide significant understanding relevant to the QS stellarator concept, reducing, but not eliminating, the need for intermediate scale experiments.

- Evaluation Synopsis: *This ITER-era goal addresses critical scientific and technical issues for quasi-symmetric stellarator configurations. Achieving the goal will advance the knowledge of steady-state confinement, but requires significant extrapolation in plasma parameters to demonstrate the benefits of the quasi-symmetry, as well as a design strategy that addresses both robust flux surfaces and manufacturing constraints.*

Tier 1 Issues, Gaps, and Initiatives for Stellarator Research

1. Simpler coil systems with acceptable field errors and manufacturing tolerance

Gap: No design studies planned for quasi-symmetric stellarators

Possible Initiative: Systematic study to examine simplified QS designs and error-field correction.

2. High-performance integration of quasi-symmetric optimized stellarators

Gap: No quasi-symmetric stellarator Proof-of-Principle experiment, no similar compact stellarator.

Possible Initiative: QS stellarator of sufficient size & power to achieve high beta at low collisionality.

3. Predictive capability for confinement

Gap: Integrated nonlinear models for 3D turbulent transport and stability.

Possible Initiative: Integrated modeling and validation program for 3D plasmas (including tokamak).

4. 3D divertor power handling for quasi-symmetric configurations

Gap: Integrated divertor and core-plasma solution for QS stellarators .

Possible Initiative: Validate 3D divertor design models with high-power QS stellarator experiment.

It is clear that to achieve the ITER-era goal a quasi-symmetric experiment of sufficient scale needs to be undertaken within this time frame to demonstrate, in an integrated fashion, that the benefits of quasi-symmetry seen at the Concept Exploration level can be extended to high performance, high beta plasmas.

Scientific Benefit From Stellarator Research

- 3D Field Effects. The effect of magnetic asymmetry on confinement and stability is an issue with broad importance; RWMs in tokamaks and RFPs break axisymmetry. Non-asymmetric fields have been used to control edge-localized modes (ELMs) in tokamaks and are planned for ITER: stellarator codes are now being used to aid design of new ELM control coils in tokamaks.
- Transport. How magnetic symmetry alters transport due to electrostatic fluctuations and, especially, electron heat transport are key questions for fusion, but currently poorly understood for all concepts.
- Power Handling and Particle Control. The unique 3D geometry of the stellarator edge plasma provides an important testing platform for understanding the boundary region of fusion plasmas.
- Disruptions. An additional set of benefits to fusion science will come from tests of disruption control by means of externally imposed rotational transform.

The Spherical Torus Pushes the Tokamak To Its Low-Aspect Ratio Limit: Higher Beta, Smaller Center post

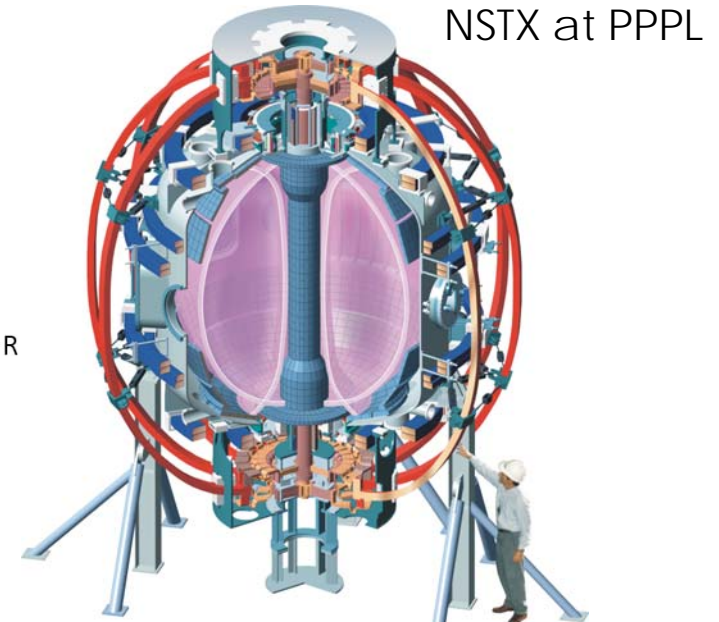
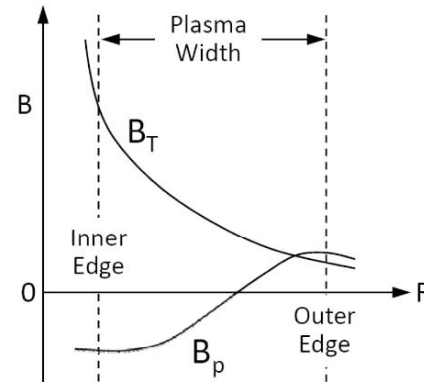
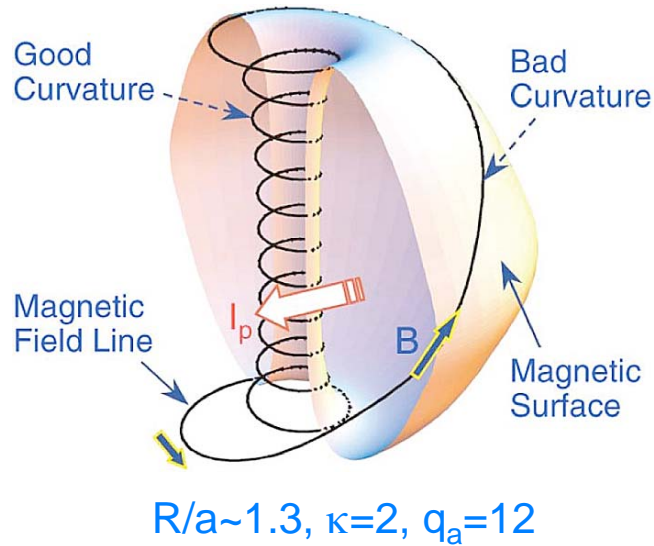

- Unshielded single-turn toroidal field ohmic transformer in center post. Non-inductive current ramp-up and current sustainment.
- Strong radial variation in B_T , with high elongation and triangularity, give increased MHD stability, higher $\langle \beta \rangle$; however, low field in plasma compared to field at coil.
- High surface area to volume ratio may enable a facility for testing fusion components.

ITER-era Goal for U.S. Spherical Torus Research

- Long-range Mission: *To develop a compact, high beta, burning plasma capability for fusion energy.*
- ITER-era goal: *Establish the ST knowledge base to be ready to construct a low aspect-ratio fusion component testing facility that provides high heat flux, neutron flux, and duty factor needed to inform the design of a demonstration fusion power plant.*

The ST goal largely aims to provide the groundwork for extending fusion development beyond the ITER mission rather than seeking primarily to achieve high-gain burning plasma conditions in the ST configuration. In addition to improved understanding of key ST physics issues, design of a reliable test facility for developing fusion components will also require a broad knowledge base in fusion technology.

- Evaluation Synopsis: *The ITER-era goal is clear, well motivated, and tied tightly to the overall fusion energy roadmap. Achieving this goal will advance knowledge of low-aspect ratio tokamak confinement, but entails significant extrapolation in non-inductive current drive, electron transport, power handling, and magnet technology.*

Tier 1 Issues, Gaps, and Initiatives for Spherical Torus Research

1. Start-up and ramp-up to multi-MA toroidal currents in over-dense plasmas

Gap: Upgrades to existing experiments will likely achieve ≤ 1 MA toroidal currents.

Possible Initiatives: New experiments testing scaling to $I_p > 2\text{MA}$.

2. Normal and off-normal divertor heat flux at high power

Gap: Must test divertor solutions at 6x higher power density with appropriate geometry.

Possible Initiatives: Divertor, power upgrades to existing expts, new experiments, edge models.

3. Electron energy transport at high temperature and low collisionality

Gap: Electron transport scaling and modeling at 10x higher T_e with low collisionality.

Possible Initiatives: Upgrades to existing experiments, new experiments, validated simulations.

4. Reliable center post magnets and current feeds with high neutron fluence

Gap: Demonstration of single-turn TF return with $B_m \sim 8\text{Tesla}$ and radiation-resistant insulators.

Possible Initiatives: Engineering R&D on appropriate magnet technologies.

The ITER-era goal requires significant extrapolation in plasma performance and the level of knowledge required. In some areas there is a sound technical basis for extrapolation but in many others the science is incomplete or untested. Achieving the ST goal is likely to require very significant resources.

Scientific Benefit From Spherical Torus Research

- Macroscopic Stability. The research program entailed in reaching this goal would extend the knowledge of tokamak plasma stability to higher β , higher elongation, and lower aspect ratio. Also, high-beta discharges at low-aspect ratio bring different mode couplings into play, which complements active mode control research (e.g., RWM, NTM, and ELM control) on standard-aspect ratio tokamaks.
- Transport. Low aspect ratio highlights the importance of neoclassical transport effects for both thermal and energetic particles. The transport in both ions and electrons scales differently in the ST than in standard-aspect-ratio tokamaks. Transport studies and comparison with gyrokinetic codes can provide important tests to theory that have broad implications to many confinement concepts.
- Boundary Physics. Understanding scrape-off-layer transport and demonstrating the compatibility of radiative dissipation and other techniques to reduce peak heat loads and surface erosion has broad application to other toroidal magnetic confinement concepts.
- Non-Inductive Current Drive. All toroidal alternates require an efficient means to form and sustain the magnetic configuration; the challenge is large in the ST due to low magnetic field and limited space for an ohmic transformer. Developments here can benefit both other alternates and standard-aspect-ratio tokamaks.

Additional Comments on Spherical Torus Research

- Relationship Between the Spherical Torus and a CTF Mission for the U.S. Fusion Program

The ST may represent an economical approach to a Component Test Facility. The Panel would like to note that a CTF mission, while very important to reach the fusion energy goal, is not at this point in time an official goal of the US Fusion program. Furthermore, even within the context of a CTF mission, the FES strategic planning process will need to consider the following critical decision points:

1. After sufficient research on STs and Tokamaks, the optimal aspect ratio for CTF should be assessed.
2. Well in advance of a decision to proceed with a CTF, the program roadmap would need to expand basic research in materials and engineering sciences to accompany development of the ST physics basis.

- Relationship Between the Spherical Torus and the Tokamak.

The panel spent some time seeking to understand the differences between the spherical torus and the higher-aspect-ratio tokamak as two separate toroidal confinement concepts with distinct physics issues. Clearly, low aspect ratio and low toroidal field on axis change plasma stability and operating limits and are likely to affect transport processes, as evidenced by increased electron transport in the ST. However, a growing international database and improved theoretical understanding point to the great commonality of underlying physics between the spherical torus and the tokamak, thus blurring the distinction between these devices. Planned upgrades to the two largest ST facilities, NSTX and MAST, will increase their aspect ratio, bringing them closer to the operating space of other tokamaks.

The Reversed-Field Pinch Uses Internal Currents to Produce Most of the Toroidal Magnetic Field

- Weak external TF field, with sufficient ohmic current to drive q below unity.
- Force-free plasma relaxation produces reversed Toroidal Field in core. Edge poloidal current effectively acts like a Toroidal Field coil.
- High field in plasma relative to field at the coils.
- Internal magnetic fluctuations or "Plasma dynamo" sustains current, but opens field lines via reconnection.
- Oscillating Field Current Drive might replace the ohmic transformer for steady state operation.

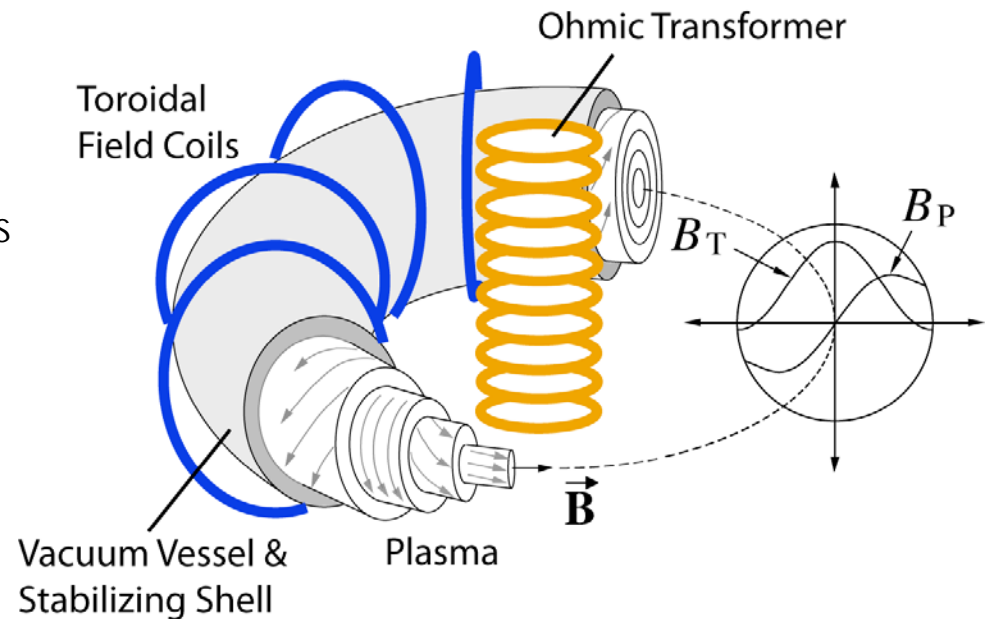

ITER-era Goal for U.S. Reversed-Field Pinch Research

- Long-range Mission: *Develop the scientific and technical basis for a fusion power source that uses a small externally applied magnetic field*
- ITER-era goal: *Establish the basis for a burning plasma experiment by developing an attractive self-consistent integrated scenario: favorable confinement in a sustained high beta plasma with resistive wall stabilization.*

This goal focuses on conducting the integrated scientific research on confinement, stability, and sustainment which would be necessary to be ready to begin construction of a burning plasma reversed field pinch. Because magnetic self-organization plays a fundamental role in the operation and performance of the RFP, achieving this goal also informs fusion science independent of its potential as a fusion energy concept.s.
- Evaluation Synopsis: *The ITER-era goal is clear and addresses critical scientific and technical issues for the RFP approach. Achieving this ambitious goal would establish the possibility for a low-external field approach to magnetic fusion. Significant challenges in establishing current sustainment with good confinement will need to be overcome to realize this goal.*

Tier 1 Issues, Gaps, and Initiatives for Reversed-Field Pinch Research

1. Confinement scaling and transport mechanisms

Gap: 3x smaller ρ^* in experiment and Lundquist number >10x smaller in both simulation and experiment

Possible Initiatives: Advanced PoP-level experiments with longer pulse and higher current; new experiment; faster simulations

2. Current sustainment by oscillating field current drive (OFCD) or long-pulse inductive operation

Gap: Higher plasma temperatures and fields to increase OFCD efficiency (>10x higher Lundquist number)

Possible Initiatives: Long pulse, high temperature experiment to demonstrate 100% OFCD.

3. Integration of current sustainment and good confinement at high Lundquist number ($\tau_R/\tau_A \propto I_p T_e^{3/2} \sqrt{n_e}$)

Gap: Higher plasma temperatures and RWM control are needed to achieve 100% OFCD without large perturbations

Possible Initiatives: New experiment achieving multi-MA, multi-keV temperatures with RWM control and OFCD; new two-fluid and gyrokinetic codes.

Achieving the ITER-era goal requires significant increase in plasma parameters; risk could be mitigated by a step-wise approach involving research on current experiments, proceeding to an advanced Proof-of Principle experiment, and finally to a Performance Extension experiment as results warranted.

Scientific Benefit From RFP Research

- Transport. Current profile control in the RFP provides a powerful tool to study transport in regimes controlled by either magnetic or electrostatic turbulence in regimes for which magnetic shear and the gyroradius are relatively large.
- MHD Stability and Beta Limits. The RFP is susceptible to multiple resistive wall instabilities even at zero beta. Thus, RFP research has and will continue to develop feedback techniques for multiple mode stabilization directly applicable to other configurations. Recently beta values have been achieved that exceed theoretical MHD stability limits for localized interchange and global tearing modes; study will be valuable to other concepts.
- Magnetic Self-Organization. Spontaneous reversal of the toroidal field in the RFP represents a clear case of magnetic self-organization, similar to the formation of the spheromak and field-reversed compact torus (FRC). Thus, studies of reconnection, dynamo alteration of the current density profile, momentum transport, reconnection heating of ions, transport from magnetic stochasticity, and magnetic helicity transport in the RFP are particularly relevant to these other configurations.
- Astrophysics. Through magnetic self-organization, RFP physics has strong links to related phenomena in space and astrophysical plasmas, as exemplified by the central role of MST in the NSF/DOE Physics Frontier Center for Magnetic Self-Organization in Laboratory and Astrophysical Plasmas (CMSO).

Compact Torus Configurations Use Self-organized Internal Plasma Currents to Produce the Confining Magnetic Field

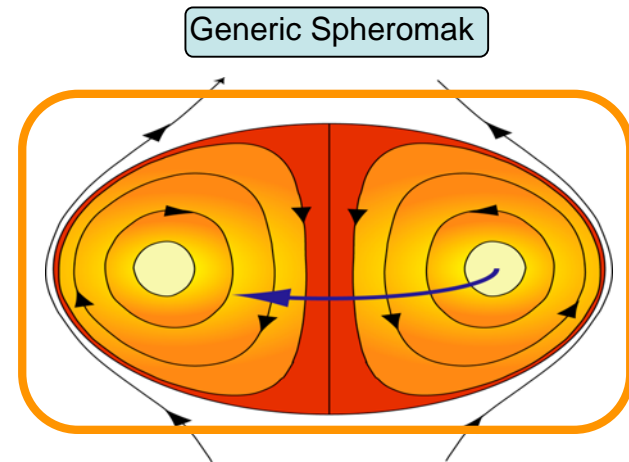
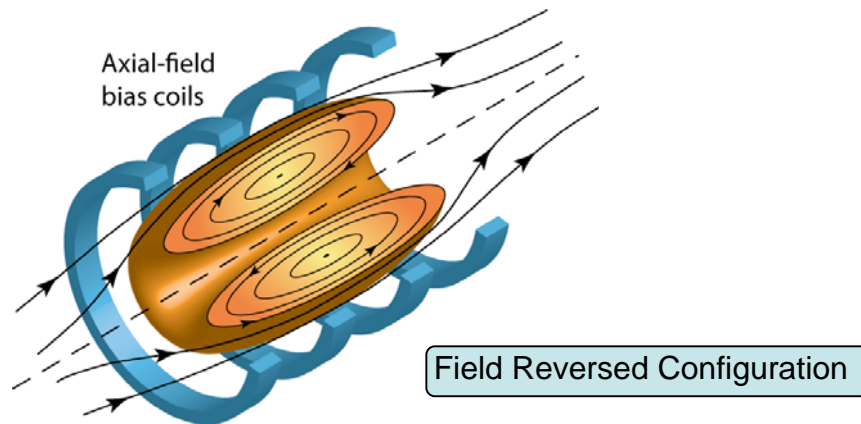

- Simply connected plasma chamber offers potential for smaller, cheaper reactors
- Very distinct geometry and physics
 - FRC: no toroidal field, diamagnetic currents only
 - FRC: $\beta \sim 1$ stabilized by finite Larmor radius effects
 - FRC: Sustained by Rotating Magnetic Field current drive or NBI
 - Spheromak: toroidal and poloidal fields, force-free currents
 - Spheromak: wall stabilizes tilt instability, $\beta \sim 0.1$
 - Spheromak: sustainment by magnetic fluctuations (helicity transport)

ITER-era Goal for U.S. Compact Torus Research

- Long-range Mission: *Develop a compact magnetic fusion reactor without toroidal field coils or a central solenoid.*
- ITER-era goal: *To demonstrate that a compact toroid with simply connected vessel can achieve stable, long-pulse plasmas at kilovolt temperatures, with favorable confinement scaling to proceed to a pre-burning CT plasma experiment.*

The CT goal aims to move from present concept exploration experiments to a proof-of-principle-scale experiment in order to provide a solid scientific basis (performance and scaling) for continuing CT research with the eventual goal of fusion energy. The CT program involves two partially related, but still significantly different concepts – the spheromak and the field reversed configuration (FRC).

- Evaluation Synopsis: *The ITER era goal for the CT is clear and aims for critical progress toward fusion energy with self-organized plasmas; achieving this goal would advance and validate magnetic confinement in a simply-connected chamber with no external toroidal field. However, the goal is highly ambitious, requiring a large extrapolation in stability, confinement, and sustainment, and there is limited theoretical or experimental basis for prediction.*

Tier 1 & 2 Issues, Gaps, and Initiatives for Compact Torus Research

1. MHD stability of the FRC at low collisionality with large-s ($a/\rho_i \geq 30$)

Gap: Experimental demonstration with $s \geq 10$; MHD calculations showing stability with $s \geq 10$

Possible Initiatives: New experiments with higher field and larger radius

2. Efficient spheromak formation techniques to achieve multi-Tesla magnetic fields

Gap: Experiments achieve 1 Tesla or less with limited flux amplification

Possible Initiatives: Extensive resistive MHD simulations, new experiments to test formation techniques

3. Efficient sustainment with good confinement (FRC and Spheromak)

Gap: FRC: 10x increase in plasma current Spheromak: Efficient sustainment at multi-MA currents

Possible Initiatives: Larger size RMF facility or tangential neutral beam (FRC); Flexible multi-pulse spheromak.

4. Transport (FRC and Spheromak)

Gap: FRC: Transport properties are unknown. Spheromak: Large uncertainties in ohmic input power.

Possible Initiatives: Profile measurements in the FRC, auxiliary heating in the spheromak.

Although it would require a major increase in CT funding to significantly advance CT research, this would have only a modest impact on the overall fusion budget. A combination of improved diagnostics, theory and simulation is needed to show how either concept can solve its difficult physics problems before making a large new step.

Scientific Benefit From Compact Torus Research

- Reconnection Physics and Resistive MHD. Formation and buildup of both the spheromak and the FRC are governed by magnetic reconnection and other resistive MHD physics. Events resulting from these are ubiquitous in both laboratory and space/astrophysical plasmas. Both concepts can therefore play an important role in validating 3D resistive MHD codes, which are now being applied to problems such as disruption mitigation and ELM control in tokamaks. Reconnection studies on the spheromak complements similar work on the RFP, and both devices have contributed to the NSF/DOE Center for Magnetic Self-Organization in Laboratory and Astrophysical plasmas.
- MHD Stability. Overall MHD stability of the FRC is not well understood but is thought to be largely due to finite-gyroradius effects, especially at low-. At higher , a minority population of fast ions or plasma flow may stabilize low- modes. The FRC thus provides a test bed for extending MHD analysis into this new regime.
- Helicity Injection and Transport. The spheromak relies on DC helicity injection to build toroidal current, as does the RFP. Both concepts seek to sustain their discharges with minimal impact on confinement through current profile control to adjust helicity transport by magnetic fluctuations. More recently, DC helicity injection has been used for ST startup in HIT-II and NSTX. These experiments are using common simulation tools such as the NIMROD code to analyze results and understand implications for next step experiments and there is close connection between the spheromak and ST communities on this subject.

Summary

- **ITER-era goals have been identified and evaluated for each concept**
 - All are ambitious, some more so than others.
 - Working towards these goals will yield important benefits to fusion science
 - Reaching these goals would be a significant achievement for fusion energy development
- **Scientific and Technical issues have been identified and prioritized**
 - Strong consensus on the most important issues, which are clearly motivated by ITER-era goals
 - Resolving these issues requires coordinated effort in theory and experiment for fundamental understanding
 - Should clearly inform follow-on DoE strategic planning process (ReNeW)
- **Assessed existing capabilities (including upgrades) and identified gaps**
 - Upgrades to existing facilities, codes, and diagnostics can in many cases yield important new information
 - Significant extrapolation in plasma parameters are required to validate physics basis for ITER-era goals
 - Ultimately, achieving ITER-era goals will require new capabilities (simulation and experiment) for all concepts
- **Identified broad scientific benefits for research on these toroidal magnetic alternate concepts**
 - Many shared issues among alternates (and the tokamak) mean shared tools, approaches, and relevant results
 - Effective vehicle for recruiting and training bright young scientists for the U.S. fusion program

General Findings

1. The overall quality of the science in toroidal alternates research is excellent, with broad benefit to the U.S. fusion program and to general plasma sciences including applications to other disciplines. The work is strongly focused on developing scientific understanding as the path forward to achieving ITER-era goals.
2. Alternate Concepts research provides significant benefit to the broader U.S. fusion and plasma science program by effectively recruiting and training bright young people to be our nation's next generation fusion scientists.
3. Predictive simulation plays a central and increasingly visible role in toroidal alternates research, in many cases pushing the state-of-the-art computational capability.
4. Alternate concept research requires similar tools to other parts of the fusion program, but it has uniquely urgent needs in two areas: (1) theory and simulation, which are particularly challenged by complex 3D resistive MHD physics, kinetic effects, and anomalous transport seen in these experiments; and (2) diagnostic capability, which is especially vital for the less mature concepts. These areas deserve priority emphasis and support within the alternates program to strengthen scientific contributions and solidify projections to next step experiments.
5. Promise for Fusion Energy: Some of the four concepts we have considered are much more highly developed than others, yet all of them require further development and investigation before any definitive assessment of their fusion energy capabilities is possible.

Back-up Material:

- The Stellarator
- The Spherical Torus
- The Reversed Field Pinch
- The Compact Torus (Field Reversed Configuration and Spheromak)
- Additional process information

US Stellarator Program Is Focused on Quasi-symmetric Configurations to Optimize Confinement

- Helical field variation from stellarator coils enhances neoclassical transport losses. Configuration optimization that minimizes the variation in $|B|$ or "effective ripple" ϵ_{eff} along one coordinate produces "quasi-symmetric" configurations which can be built at low R/a: compact stellarators.
- US-developed configurations use:
 - quasi-axisymmetry with bootstrap current (NCSX);
 - quasi-helical symmetry (HSX);
 - Torsatron with Ohmic current (CTH).

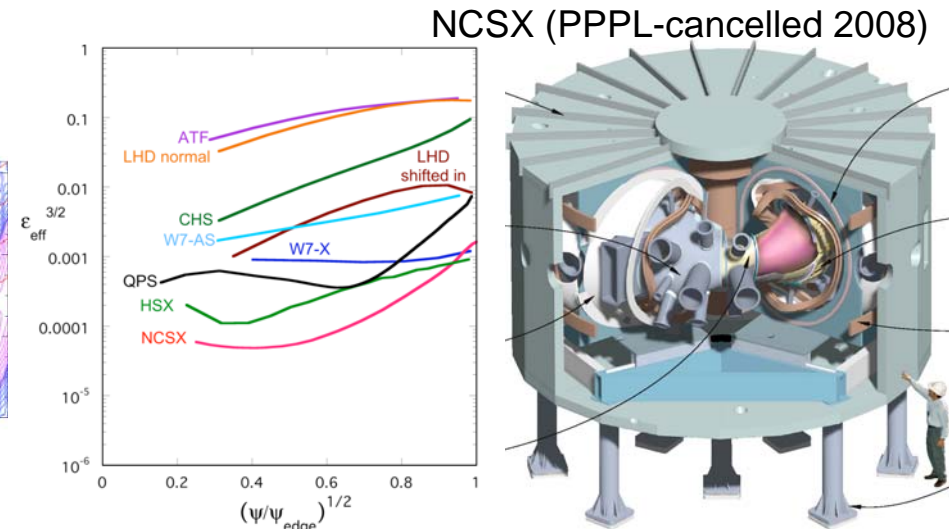
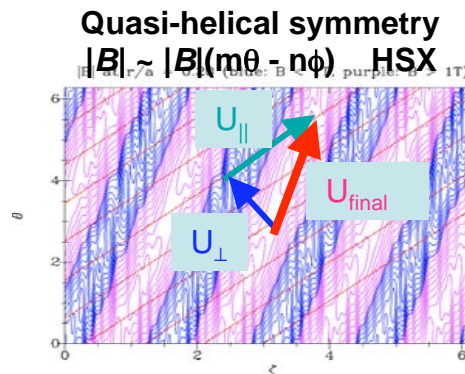
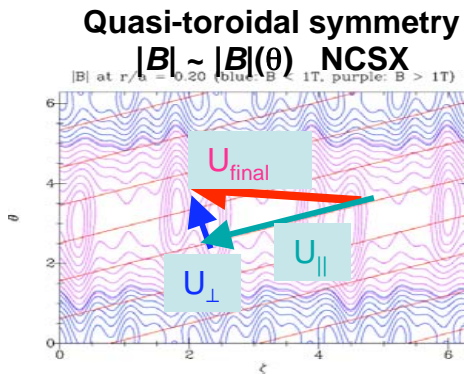
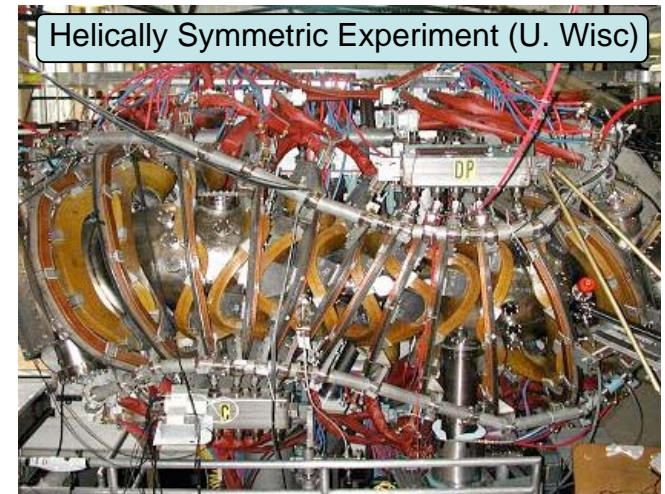

High Priority Issues for Stellarator Research

- **Tier 1 Issues**

- Simpler coil systems.
- Integrated high performance of quasi-symmetric optimized stellarators .
- Predictive capability for confinement
- 3D divertors for quasi-symmetric configurations

- **Tier 2 Issues**

- Operational limits (density and beta limits)
- Impurity control and fusion ash accumulation
- Anomalous transport reduction in quasi-symmetric configurations

- **Tier 3 Issues**

- Energetic particle instabilities
- Disruptions with finite bootstrap currents
- ELMs in high performance stellarator plasmas
- Profile sensitivity for operational limits
- Superconducting stellarator coils (High T_c coils)

U.S. Spherical Torus Experiments Address A Wide Range Of Issues: Startup, Transport, Stability, and Power Handling

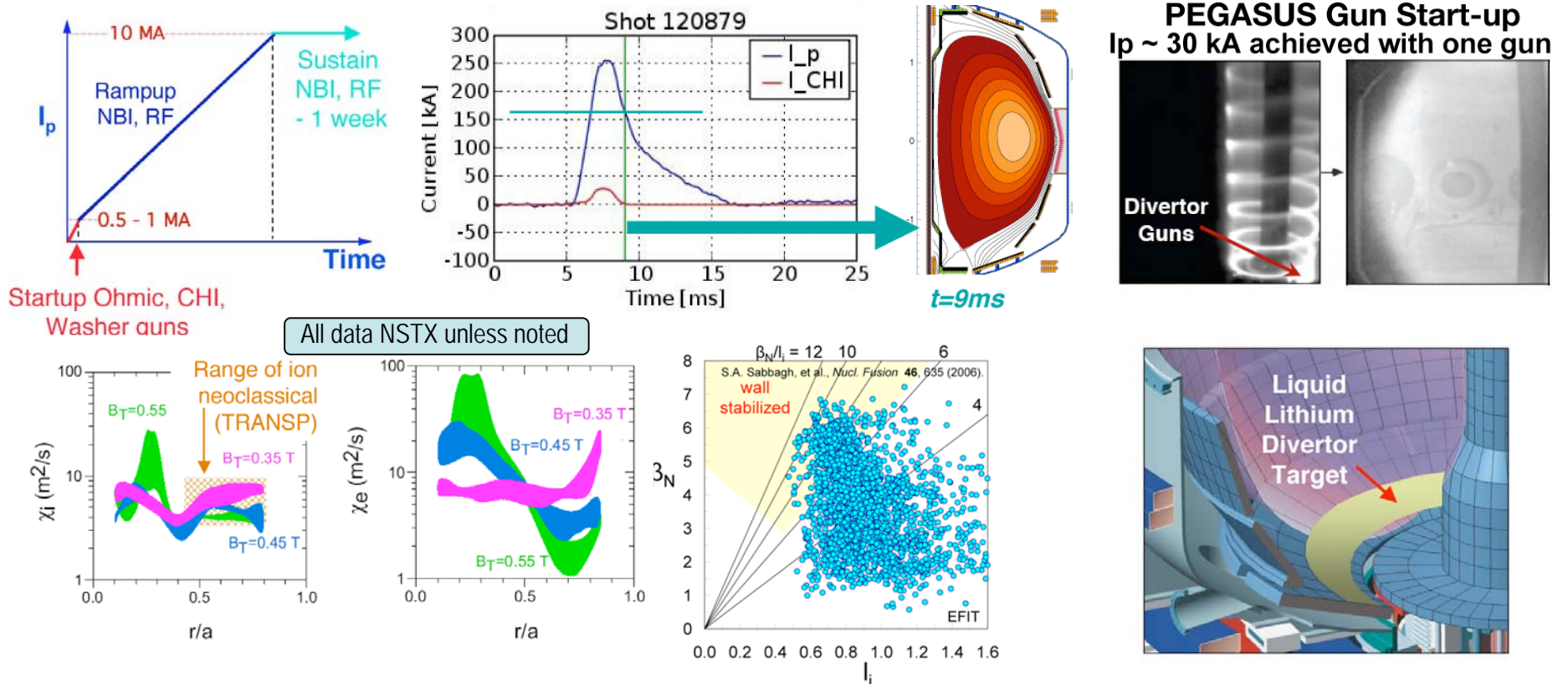

- Data over the last decade shows that essential physics is common with conventional aspect-ratio tokamak, (START, NSTX, MAST) but in different regimes. "Distinction is blurred".

High Priority Issues for Spherical Torus Research

- **Tier 1 Issues**

- Start-up and ramp-up to multi-MA currents
- Plasma-material interface: normal and off-normal divertor heat flux
- Electron energy transport at high temperature and low collisionality
- Reliable center post magnets and current feeds with high neutron fluence

- **Tier 2 Issues**

- Demonstrated integrated high performance scenarios
- Disruption avoidance and mitigation for reliable continuous operation
- Efficient RF heating and current drive at MA levels in over-dense plasmas
- Control of error fields, ELMs, and RWM using remote coils
- Predictive understanding of ion transport (flow shear turbulence suppression)
- Impact of fast-particle instabilities on NBCD and heating

- **Tier 3 Issues**

- Avoidance of neoclassical tearing modes near the no-wall beta limit
- Reliable (+/-) neutral beam operation for 10^6 sec. (2 weeks)

Reversed-Field Pinch Experiments Are Examining Current Drive, Confinement, and MHD Stability

Oscillating Field Current Drive

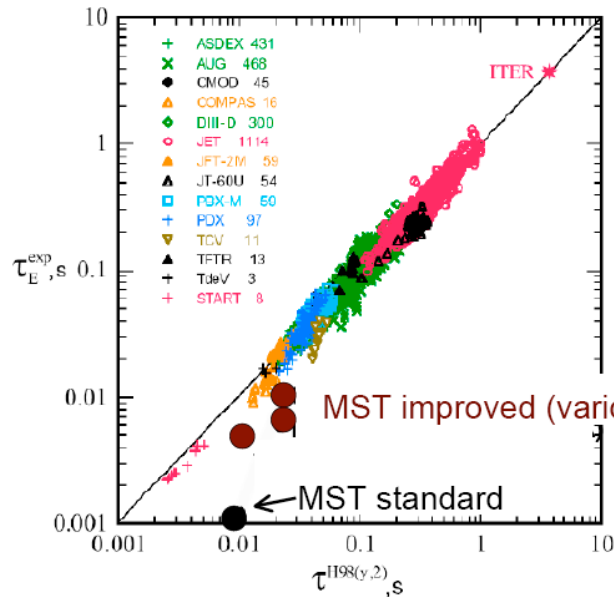
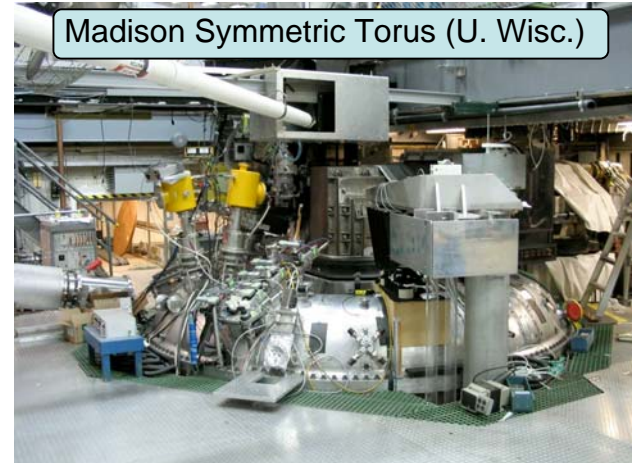
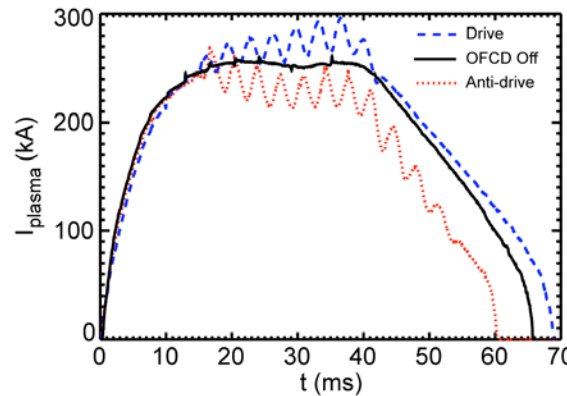
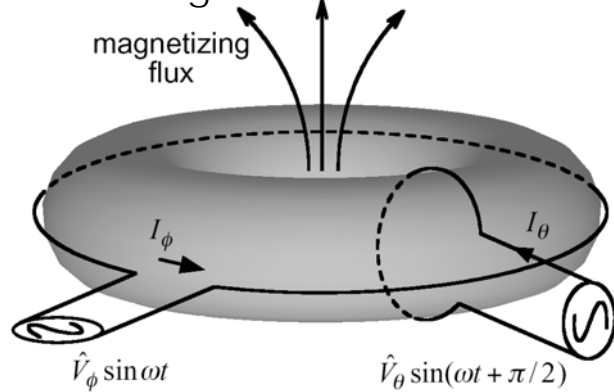

Reversed Field Experiment (Italy)
RWM control

Total of 192 active coils.

100% coverage of the mechanical structure external surface.

Each saddle coil is fed with its own power supply.

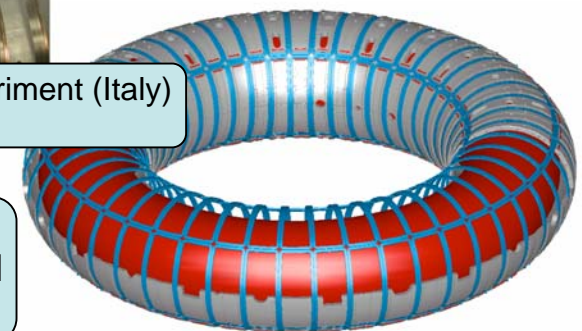

Hotter, higher field plasmas reduce CD requirements and may improve confinement

High Priority Issues for the Reversed-Field Pinch

- **Tier 1 Issues**

- Identify transport mechanisms (magnetic & electrostatic) and establish confinement scaling
- Current sustainment by oscillating field current drive or long-pulse inductive operation
- Integration of current sustainment and Improved confinement at high Lundquist number (τ_R/τ_A)

- **Tier 2 Issues**

- Plasma boundary interactions (divertor/limiter configurations consistent with RFP operation)
- Energetic particle stability (largely unmeasured in the RFP)
- Understand limits to plasma pressure which occur well below the ideal MHD limit

- **Tier 3 Issues**

- Development of self-consistent reactor scenarios (confinement, sustainment, RWM, divertor)
- Multi-mode Resistive Wall Mode Control in the fusion environment

State-of-the-art CT Experiments Are Not Large (Concept Exploration Class Devices)

Field Reversed Configuration (TCS-U @ U. Wash.)

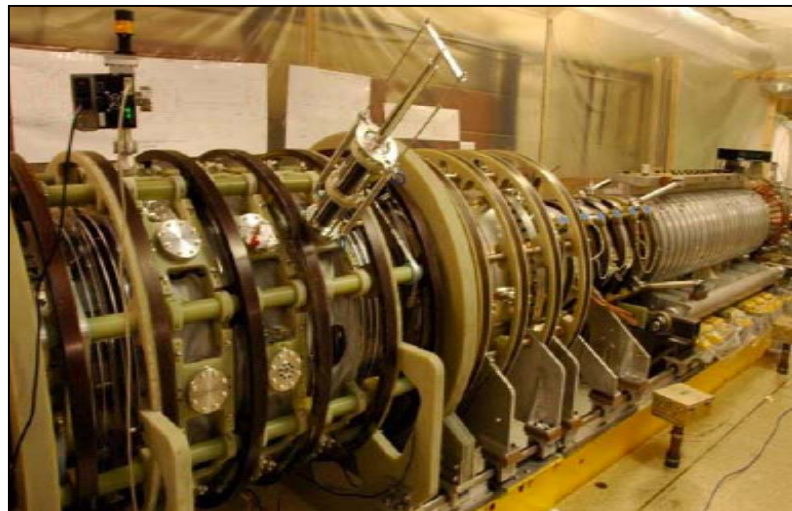
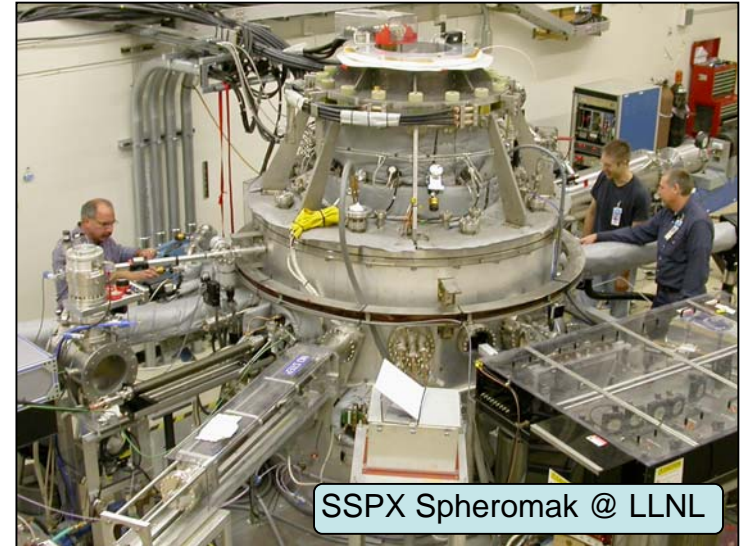
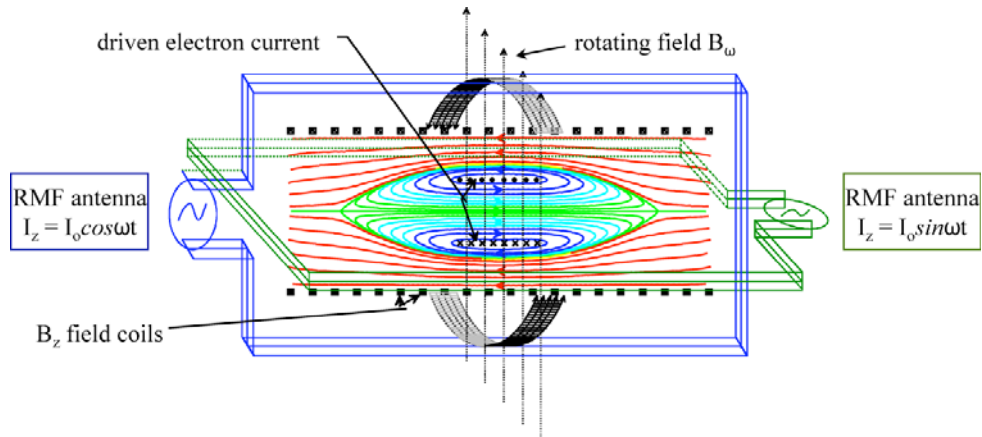

1m diameter
 Te ~250eV
 3msec pulse
 0.03 Tesla
 RMF drive

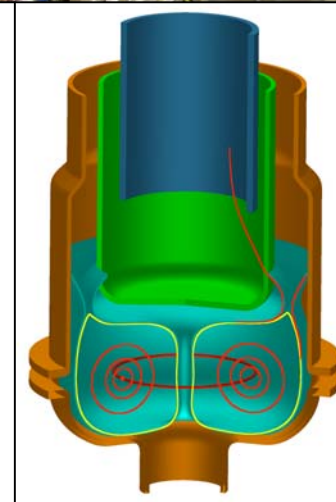

1m diameter
 Te ~500eV
 10msec pulse
 0.8 Tesla
 Coaxial Injection

LLNL closed SSPX in 2008

High Priority Issues for The Field-Reversed Configuration

- Tier 1 Issues
 - MHD stability at low collisionality with large s ($a/\rho_i \geq 30$)
- Tier 2 Issues
 - Measure scaling of and reduce anomalous transport in low collisionality plasmas
 - Demonstrate efficient current drive (Rotating Magnetic Field or Tangential NBI with good confinement)
- Tier 3 Issues
 - Understand large-orbit fast-particle effects
 - Demonstrate efficient FRC heating via RMF, NBI, or compression

High Priority Issues for The Spheromak

- **Tier 1 Issues**

- Efficient time-averaged current sustainment at MA levels consistent good confinement
- Develop efficient formation techniques to achieve multi-Tesla magnetic fields

- **Tier 2 Issues**

- Determine transport mechanisms and confinement scaling in low-collisionality plasmas
- Determine the relative role of power transport and MHD stability in setting the beta limit
- Develop density control for long-pulse spheromak plasmas

- **Tier 3 Issues**

- Energetic particle confinement in the spheromak configuration
- Develop techniques for $n=1$, $m=1$ tilt/shift RWM control in long-pulse plasmas
- Develop appropriate technology for steady-state coaxial helicity injection

Working Groups Bring Requisite Focus To Each Concept

Panel Members	ST	Stellarator	RFP	CT	At Large
Dave Hill (C)					X
David Anderson		E(L)			
Jeff Freidberg				AL	X
Martin Greenwald	AL				X
Houyang Guo				E(L)	
Richard Hazeltine (VC)	Th	Th			X
Bick Hooper				E	
Hantao Ji			E(L)		
Tim Luce		AL			
Dale Meade			AL		X
Jon Menard	E				
Martin Peng	E(L)				
John Sarff			E		
John Sheffield	AL				X
Xianzhu Tang			Th	Th	X
Ed Thomas		AL			X
Mike Zarnstorff		E			
Totals	5	5	4	4	9

- Working groups consist of concept experts and at-large members
- Working group experts know the research community for their concept
- At-large members facilitate communication to larger fusion community

Identifying the ITER-era Goals

1. Community put forward ITER-era goals for the concepts
2. Panel discussed, provided feedback, sought clarification
3. Based on response, each concept working group wrote down goal with description
4. At-large members made an initial evaluation of the goal using the questions on the next slide.
5. Full panel evaluated the goal during discussion led by at-large members
6. At-large members drafted text of goal evaluations.
7. Two types of goals:
 - Specific set of target conditions or certain level of performance
 - Knowledge base or “scientific basis”

Promise For Fusion Energy Among Approaches

- Economically attractive fusion power remains a future goal, regardless of approach.
- Two major experiments to demonstrate fusion gain $Q > 1$ are under construction: ITER (tokamak, Int'l project, sited in France) and NIF (IFE, U.S. DOE at LLNL)
- The tokamak is the leading toroidal magnetic confinement concept due to its superior performance and due to significant long-term R&D investments
- Toroidal magnetic confinement fusion research must address common issues:
 - Plasma confinement, transport, and overall energy balance
 - Configuration sustainment (field generation, current drive)
 - Operating limits (plasma pressure, coil stresses, fuel-density)
 - Thermal loads and operating lifetime of PFCs
 - Plasma exhaust, particle control, overall tritium fuel cycle
 - Wall neutron loading (thermal loads and neutron damage)
 - Safety, reliability, maintainability, environmental impact
- Advocates for alternate toroidal magnetic confinement concepts seek an attractive reactor by exploring ways to improve one or more of these common MFE issues.