

Report from the FESAC Subcommittee on Future Facilities

John Sarff
University of Wisconsin-Madison

Subcommittee members

- Rich Callis (GA)
- Ray Fonck (UW)
- Chuck Greenfield (GA)
- Chuck Kessel (PPPL)
- Steve Knowlton (Auburn)
- Rick Kurtz (PNNL)
- Mike Mauel (Columbia U)
- Harry McLean (LLNL)
- Jon Menard (PPPL)
- Juergen Rapp (ORNL)
- Don Rej (LANL), Vice Chair
- John Sarff (UW), Chair
- Dennis Whyte (MIT)
- Martin Greenwald (MIT), ex officio
- Albert Opdenaker, ex officio

My personal thanks to this committee. They worked very hard, and donated significant personal time several weekends in a row.

The charge, Dr. Brinkman's letter dated Dec 20, 2012

- Goal: Formulate a prioritization of scientific facilities for the ten year time frame 2014-2024 across the Office of Science based on (1) the ability of the facility to contribute to world-leading science, (2) the readiness of facility construction, and (3) an estimated construction and operations cost of the facility
- Step 1: FES and other offices provided lists for
 - Proposed new scientific user facilities or major upgrades
 - Existing scientific user facilities
- Step 2 (**today's focus**): FACA subcommittees review these lists, subtracting from or adding to as appropriate
 - Reference relevant planning documents and decadal studies
 - Consider only those that require a minimum investment of \$100 million
- Step 3: DOE/SC Director will prioritize the proposed new facilities and major upgrades across scientific disciplines according to his/her assessment of the scientific promise, readiness, and the cost of construction and operation

Categorization for world-leading science and readiness (pg 3 of charge letter)

Assign each of the existing and proposed new/upgraded facilities to a category and provide a short justification in the following two areas, but do not rank order the facilities:

1. The ability of the facility to contribute to **world-leading science**

Consider, for example:

- Extent to which the facility/upgrade would answer the most important scientific questions
- Other ways or other facilities that would be able to answer important questions
- Would contribute to many or few areas of research, especially whether the facility will address needs of the broader community of users
- Will create synergies within a field or among fields of research
- What level of demand exists within the (sometimes many) scientific communities that use the facility
- Place each in one of four categories: (a) absolutely central; (b) important; (c) lower priority; and (d) don't know enough yet

Categorization for world-leading science and readiness (pg 3 of charge letter)

continuing:

2. The **readiness** of the facility for construction (proposed new & upgrade only)

Please consider, for example:

- Whether the concept of the facility has been formally studied
- Level of confidence that the technical challenges involved in building the facility can be met
- Sufficiency of R&D performed to date to assure technical feasibility
- Extent to which the cost to build and operate the facility is understood
- Please place each facility in one of three categories: (a) ready to initiate construction; (b) significant scientific/engineering challenges to resolve before initiating construction; and (c) mission and technical requirements not yet fully defined

Subcommittee meetings

- 6 conference calls
- First in-person meeting, Friday, Feb 1, Gaithersburg
 - Further clarifications from FES
 - Guidance on conflict of interest, with DOE General Counsel
 - Discussion and organization of the Subcommittee's process
- Second in-person meeting, Saturday-Sunday, Mar 2-3, Gaithersburg
 - Discussion of strawman new facilities
 - Advanced MFE alternates
 - Materials for fusion
 - High energy density laboratory plasma research
 - Integrated toroidal plasma-material-interaction (PMI) facility
 - Fusion nuclear science facility
 - Discussion of Upgrade of DIII-D, existing facilities, Alcator C-Mod
- Approaching 1000 emails ...

Conflict of issue ground rules

- On Feb 1, the Subcommittee met with Jim Van Dam, Gene Nardella, and Brian Plessler, DOE General Counsel (very grateful for Jim Van Dam's summary below):
 - DOE's major concern is direct financial interest COI related to the institutions that employs you or your spouse.
 - If you have a consulting relationship to an institution that is proposing a facility, you need not recuse yourself, but you should state on the record what this relationship is.
 - If you are a user of a facility but not employed by the institution that hosts the facility, you need not recuse yourself, but you should state on the record that you are a user.
 - There is no problem if you are discussing the science mission that might be addressed by various facilities. However, if the discussion condenses to an obvious place for siting the facility, then you need to be careful about COI.
 - Just because a white paper is authored by someone from your institution, you do not need to recuse yourself. However, if the content of the white paper indicates that only a few institutions (one of which is yours) could host the facility, then you should recuse yourself.
 - Subcommittee members should not be authors on white papers.
 - Subcommittee members may add proposals to the list if an important possible facility is not covered through a white paper.
 - For upgrades to a facility at your institution, you may not participate in the subcommittee's evaluation, and you also may not participate in providing background information and context.
 - If there are multiple competing proposals for facilities to address the same science issues and one of those proposals is from your institution, you should note this fact on the record and be careful not to appear that you are bashing the other proposals.
 - Recusal means leaving the room. For a private meeting of the subcommittee by conference call or video, recusal means hanging up, not just hitting the mute button. For in-person or remote meetings that are public where input from people is being received, when something is presented that is related to your institution, you don't need to leave the room or hang up, but you do need to be silent and not ask questions or engage in any way.

Conflict of issue resolution – main points

- Subcommittee members were not co-authors of white papers
- Members declared their “direct” and “potential” conflicts of interest on all facilities under discussion. A “direct” conflict arises primarily by the Member’s employer relationship (the COI emphasis is on financial gain).
- Members were recused from discussion and voting for facilities on which they had a direct conflict of interest
- We managed reasonably well, although one situation arose where a gap in the COI procedure was exposed by having one common email list-serve address. This was resolved promptly and a new email procedure was adopted to recuse Members with direct COI.

Facilities that were provided to FESAC by FES (Step 1)

- Proposed new and upgraded facilities:
 - Fusion nuclear science facility (FNSF)
 - Materials initiative (two smaller facilities)
 - Quasi-axisymmetric stellarator experiment (QUASAR)
 - Upgrade of the DIII-D National Fusion Facility
- Existing facilities:
 - DIII-D National Fusion Facility (General Atomics)
 - Upgraded National Spherical Torus Experiment, NSTX-U (PPPL)
- Alcator C-Mod (MIT) was not on the list of existing facilities, consistent with DOE plans to cease C-Mod operation as described in the President's FY 2013 budget proposal

ITER was not included on FES lists, as explained in Dr. Synakowski's supplemental letter

- *“As we all appreciate, ITER is unique not only in the world-leading science it is expected to accomplish, but in how it is being conducted under an international agreement with seven Members. As a consequence, SC leadership has determined that ITER is not to be considered in this exercise.”* – E. Synakowski, FES
- The Subcommittee interpreted this as strong DOE support for the burning plasma science enabled by ITER that defines the present frontier in fusion research using magnetically confined plasmas.
- An assessment of ITER is therefore not included in this report

The FES-proposed facilities and upgrades relate to 2 of 4 strategic goals for Fusion Energy Sciences

- *Advance the fundamental science of **magnetically confined plasmas** to develop the predictive capability needed for a sustainable fusion energy source;*
- *Pursue scientific opportunities and grand challenges in **high energy density plasma science** to explore the feasibility of the inertial confinement approach as a fusion energy source, to better understand our universe, and to enhance national security and economic competitiveness;*
- *Support the development of the scientific understanding required to design and deploy the **materials needed to support a burning plasma environment**;*
- *Increase the fundamental understanding of **basic plasma science**, including both burning plasma and low temperature plasma science and engineering, to enhance economic competitiveness and to create opportunities for a broader range of science-based applications*

Call for white papers was sent to the community to gather broader perspective on opportunities for facilities

- Announcement: The FESAC Subcommittee formed to address the DOE Office of Science charge on proposed scientific user facilities invites community input ... The final report for this charge must be delivered to DOE by March 22, 2013... Hence the DUE DATE FOR WHITE PAPERS IS THURSDAY, FEB 14
(two weeks notice)
- The Subcommittee also solicited white papers for DIII-D, NSTX-U, and Alcator C-Mod to support a parallel and uniform assessment process
- 37 white papers received:
 - 1 basic plasma science
 - 8 high-energy-density laboratory plasma science
 - 9 materials for the burning plasma environment
 - 18 magnetically confined plasmas
 - 1 other
- Available to the public: <http://burningplasma.org/fsff.html>
(our thanks to Jim DeKock and USBPO)

An evaluation of the white papers added context to identify and categorize facilities

- World-leading science criteria developed by the Subcommittee:
 1. Facility/upgrade addresses research needs identified in recent planning for at least one of FES's strategic goals: MFE, HEDLP, materials for fusion, basic plasma science
 2. Facility/upgrade resolves key scientific questions that are critical to development steps toward fusion power production
 3. Facility/upgrade creates opportunities for discoveries in plasma and fusion science
 4. Facility/upgrade provides unique capabilities
 5. Facility/upgrade enhances or maintains scientific leadership by the US
 6. Facility/upgrade provides a cost effective approach to answering important scientific questions
 7. Facility supports a broad community of researchers
 8. Facility creates synergies through multi-disciplinary research

An evaluation of the white papers added context to identify and categorize facilities

- Readiness criteria developed by the Subcommittee:
 1. At what level are mission & facility requirements documented?
 2. At what level are facility concepts developed?
 3. At what level are technical risks analyzed and R&D plans documented?
 4. When could requisite R&D realistically be completed to initiate project?
 5. At what level are cost estimates for R&D, project, and operations documented?
 6. At what level are the schedules for R&D and the project documented?
 7. Have all of the above elements undergone independent peer review?

While the white papers provided extremely valuable input to the process, the Subcommittee's decisions on the recommended facilities were framed by the composite information in numerous available planning documents, the proposed new and upgraded facilities received from FES, together with the white papers.

The facility cost filter

- Dr. Brinkman's charge letter directs that facility cost for this exercise should be minimum \$100M
- Dr. Synakowski's supplemental letter advises that "you may consider facilities or upgrades that are below the \$100M level, although the \$20M level is probably too low."
 - In answer to a request for further clarification on scope, Dr. Synakowski advised "I think I said \$20M is too low. The boundary here is fuzzy, but I probably wouldn't push below a factor of two of the original \$100M line."
- Despite the extra freedom, facility cost is a substantial filter that eliminates many smaller facilities identified in planning documents, the white papers, and even affected the "Materials Initiative" received from FES
- Note that lower cost facilities are important for FES research generally, but are recognized particularly important for "materials for a burning plasma environment" and "basic plasma science"

Our recommended facilities provide strong options to enable world-leading science for FES's strategic goals

Facility	World-leading Science	Readiness
DIII-D National Fusion Facility	absolutely critical	(existing)
Upgraded National Spherical Torus Experiment (NSTX-U)	absolutely critical	(existing)
Fusion Materials Irradiation Facility	absolutely critical	ready to initiate construction
Fusion Nuclear Science Facility (FNSF)	absolutely critical	significant R&D before construction
Multi-Petawatt Science Facility	important	significant R&D before construction
Quasi-Symmetric Stellarator Facility	absolutely critical	significant R&D before construction
Upgrade to the DIII-D National Fusion Facility	important	ready to initiate construction

Existing Facilities

DIII-D National Fusion Facility (existing)

World-leading science: *(a) absolutely critical*

- Mission is to establish the scientific basis for the optimization of the tokamak approach to fusion
 - Resolve critical issues for burning plasma science
 - Develop the physics basis for steady-state operation
 - Develop the scientific and technical basis for FNSF
- Largest fusion experiment in the U.S., and one of the premier tokamak facilities in the world
 - Flexible experimental capabilities for control of plasma shape and profiles
 - Broad range of heating and current drive systems
 - More than 50 state-of-the-art diagnostic systems
- Provides critical support for the success of ITER
 - Reduce the risk and consequences of sudden plasma termination
 - Develop high performance confinement regimes
 - Improve understanding of 3D magnetic field interactions with the plasma

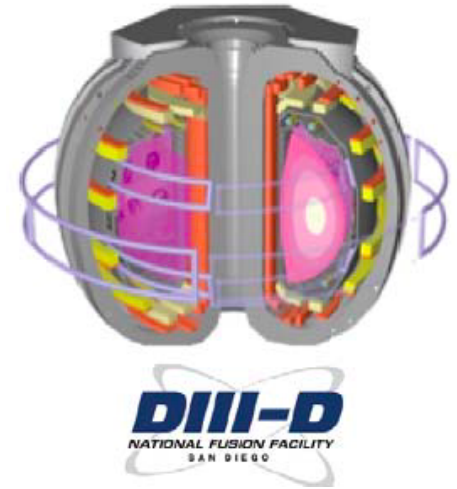

Upgraded National Spherical Torus Experiment, NSTX-U (existing)

World-leading science: *(a) absolutely critical*

- Mission is to develop the tokamak physics basis with unique capabilities to explore the low aspect ratio regime
 - High normalized plasma pressure (beta)
 - Advanced plasma boundary control and materials
- Presently undergoing a major upgrade to double the range of key plasma and device parameters
 - Upgrade doubles the magnetic field, plasma current, and heating power
 - Pulse length increased from 1 second to 7 seconds
 - Explore plasmas with reduced collisionality, key to understanding confinement physics
- Multiple contributions to advancing fusion plasma science
 - Contributions critical to ITER, e.g., energetic particle physics
 - Develop new solutions for the plasma-material interface
 - Establish the physics basis for a FNSF

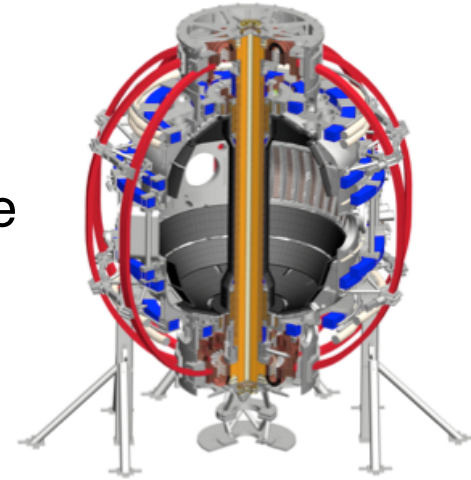

On Alcator C-Mod

- The future of Alcator C-Mod is presently uncertain
- The recently completed *Report of the FESAC Subcommittee on the Priorities of the Magnetic Fusion Energy Science Program*, chaired by Dr. Robert Rosner, recommended that if FES funding at the FY 2012 becomes available, then “roughly one-third of the restored funds, \$12M per year, should be deployed for a three to five year period of operation of C-Mod to resolve high-priority topics on ITER-relevant boundary and divertor physics, and might include upgrades as required to accomplish these goals.”
- The Subcommittee concurs with this assessment and recommendation



New and Upgraded Facilities

Fusion Material Irradiation Facility

World-leading science: (a) *absolutely critical*

Readiness: (a) *ready to initiate construction*

- Mission is to provide a new laboratory that produces a high flux of fusion-relevant neutrons on material samples, thereby transforming nuclear materials science
- Facility will fill a gap in providing an irradiation volume > 0.4 liters and high availability $> 70\%$
 - Atomic displacement damage of > 20 dpa/year
 - Complex temperature and environmental control
 - Larger test volumes at medium & low irradiation for sub-component assemblies
- Supports frontier materials science that aims to predict material performance with high confidence and allow the design of new materials with improved performance

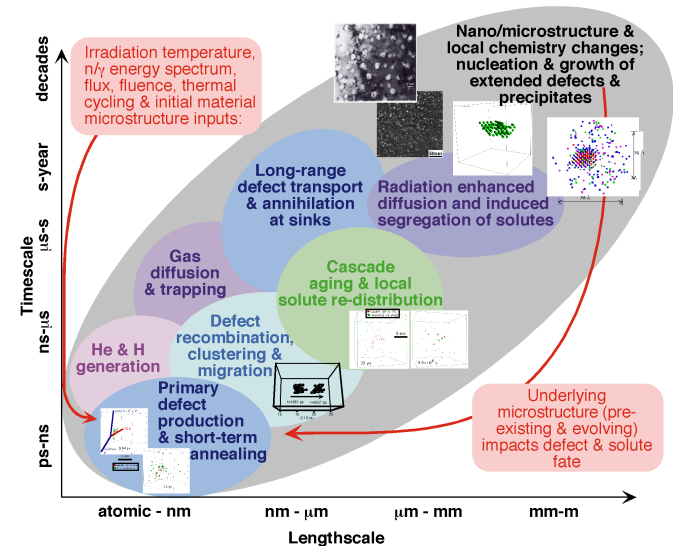

Fusion Nuclear Science Facility (FNSF)

World-leading science: *(a) absolutely critical*

Readiness: *(b) significant scientific/engineering challenges to resolve...*

- Mission is to provide first-ever integrated and controlled fusion environment that resolves strong couplings of
 - High performance plasma core
 - Plasma-material interactions
 - Fusion neutron science and extreme material alteration
- The FNSF is a minimally sized toroidal device producing a fusion neutron flux prototypical of a reactor
 - Operation for long durations to understand multi-physics processes
 - Tritium breeding from lithium blanket surrounding the plasma
 - Flexibility for rapid changeover of components
- Staged operation, beginning with non-nuclear phase to resolve key challenges of the plasma-material interface, with subsequent nuclear stages to reveal material alterations in an intense neutron environment

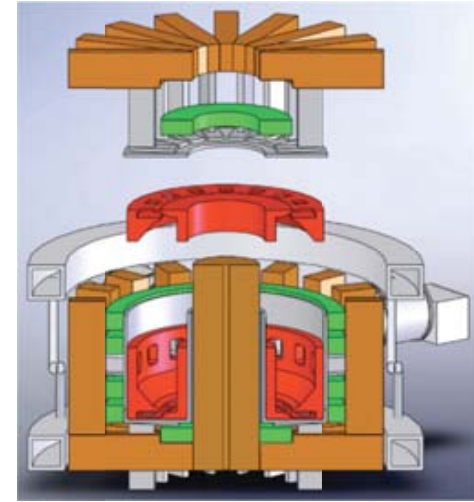

Multi-Petawatt Science Facility

World-leading science: *(b) important*

Readiness: *(b) significant scientific/engineering challenges to resolve...*

- Mission is to produce the highest focused-laser intensity ever, and use that capability to expand the frontier of high energy density plasma science
 - Self-emission of electromagnetic radiation
 - Relativistic protons (and electrons)
 - Matter/antimatter appear at extreme field intensity
- Facility will provide advanced lasers with 10^{23-24} W/cm² intensity at power levels 10-100 PW
 - Repetition rates 0.001-0.1 Hz and possibly greater
 - Supplemental diagnostic and heating laser beams
 - Flexible target chamber to support diverse experiments
- Opportunity to leverage U.S. expertise and surpass planned capabilities elsewhere in the world

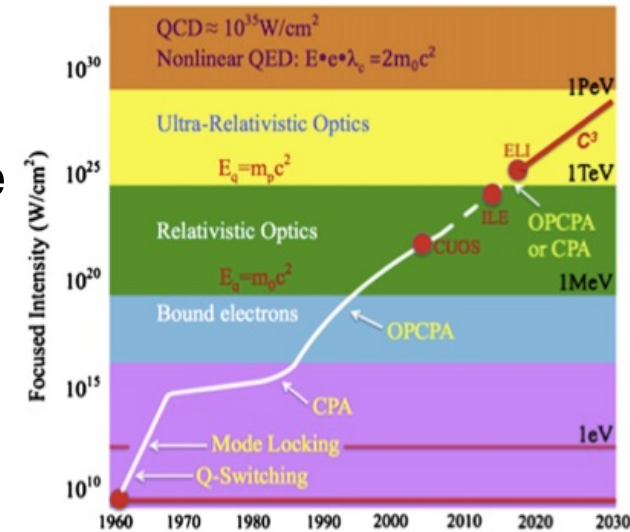

Quasi-symmetric Stellarator Facility

World-leading science: *(a) absolutely critical*

Readiness: *(b) significant scientific/engineering challenges to resolve...*

- Mission is to explore the confinement-optimized quasi-symmetric stellarator as one means of addressing the high priority need for controlled steady-state, disruption-free fusion plasmas
- Facility capitalizes on U.S. leadership in designing 3D plasma confinement systems that possess 2D-like symmetry
 - Plasma heating capabilities that demonstrate superior thermal and energetic ion confinement
 - Particle and power exhaust control consistent with magnetic field symmetry
 - Access to spontaneous plasma flows and improved confinement regimes
- Juxtaposition of scientific investigation using distinct magnetic geometries will lead to a deeper understanding of confinement in all high-performance toroidal plasmas

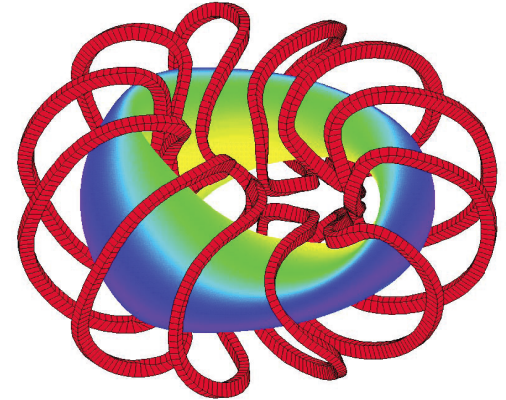

Upgrade to the DIII-D National Fusion Facility

World-leading science: *(b) important*

Readiness: *(a) ready to initiate construction*

- An upgrade of the DIII-D facility will greatly enhance its mission to establish the scientific basis for the optimization of the tokamak
 - Explore the physics of burning plasmas through increased direct heating of electrons
 - Investigate conditions for steady-state operation using a combination of enhanced off-axis neutral beam power and electron cyclotron current drive
 - Develop the 3D optimization of the tokamak configuration for edge stability and plasma rotation control using new magnetic perturbation coils
 - Resolve the plasma disruption problem for the tokamak using advanced stability control and new plasma quench mitigation systems
- The upgraded DIII-D facility will have much greater ability to support science critical to the success of ITER and to the establishment of the physics basis for FNSF

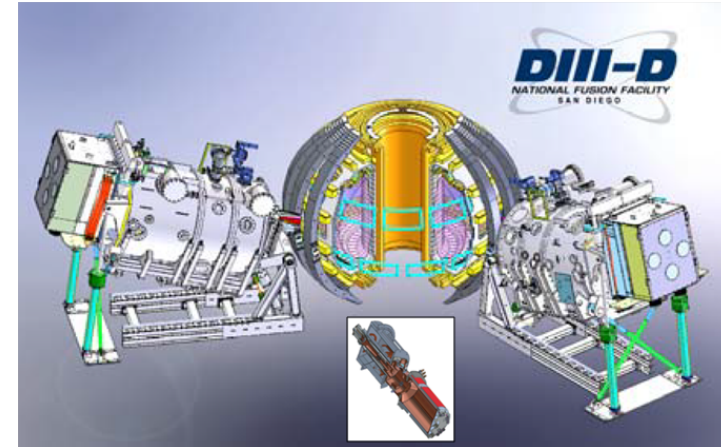

The distinction in categorization of world-leading science

- The Subcommittee is recommending facilities that we judge to have world-leading capability to meet the high standards defined by our science criteria, and that meet the parameters for this exercise. (This was evident in our evaluation of white papers, for example.)
- The distinction between “absolutely central” and “important” relates primarily to the relative impact of a facility in the world context for two of our criteria:
 - Facility/upgrade resolves key scientific questions that are critical to development steps toward fusion power production
 - Facility/upgrade provides unique capabilities

The PMI challenge – a case analysis

- Facilities needed to advance the scientific understanding of the plasma-material-interface (PMI) are discussed in several recent planning reports, e.g., *Opportunities for Fusion Materials Science and Technology Research Now and During the ITER ERA*, S. Zinkle et al., § 3.2.1.1:
 - **Smaller facilities**: linear plasma devices, magnetized plasma RF test stand, microwave test stand, high heat flux facilities, liquid metal PFCs testing
 - **Existing toroidal confinement devices**: U.S. short-pulse tokamaks, Asian long-pulse tokamaks, ITER
 - **Non-nuclear PFC/PMI** very long-pulse confinement device
 - **Fusion nuclear science facility (FNSF)**, which can include a D-D early phase of operation for PMI/PFC research
- Some of our recommended facilities are related to this framework:
 - Existing tokamaks: DIII-D and NSTX-U (and other tokamaks in the world)
 - Upgraded DIII-D
 - Multi-phase FNSF

The PMI challenge – a case analysis, continued

Issues that arose in the Subcommittee's discussions:

- No small facilities in this exercise, due to cost threshold, including PMI test stand(s)
- Upgrade to DIII-D is focused mainly on core plasma control, not the extreme boundary (advanced materials, divertor, etc), but we were informed that DIII-D has a longer term vision for this area (6-10 years from now)
- Alcator C-Mod may not operate further; was leading U.S. effort on the front-runner material, tungsten, including novel experiments with elevated material temperature
- Lack of programmatic clarity on the optimal sequence that begins with long-pulse PMI/PFC and evolves to fusion nuclear science
- Planning documents assume the major step to a long-pulse PMI or FNSF facility will need nearer term contributions from research supported by test stands and existing facilities. Should these be assumed to be well supported in an fusion nuclear science program?
- What other FES strategic areas of research have similar interdependencies of a variety of facilities at different times and scales?

The End