

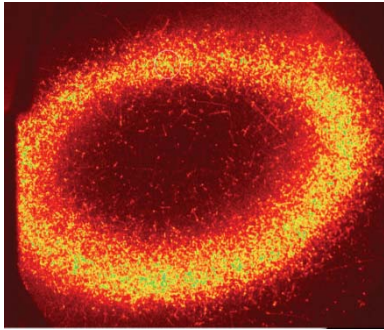

Plasma Physics and Antihydrogen



Hollow antiproton plasma
ALPHA 2012

Joel Fajans
U.C. Berkeley
and the **ALPHA** Collaboration

Work supported by:
NSF/DOE Partnership in Basic Plasma Science,

Also supported by CNPq, FINEP/RENAFAE (Brazil), ISF (Israel), MEXT (Japan), FNU and the Carlsberg Foundation (Denmark), VR (Sweden), NSERC, NRC/TRIUMF AIF FQRNT(Canada), and EPSRC, the Royal Society and the Leverhulme Trust (UK).

- Researchers have wished to study the properties of antihydrogen since at least the 1980's.
- Interest in antihydrogen stems from tests of fundamental physics:
 - Charge-Parity-Time (CPT) invariance:
 - Is the spectrum of antihydrogen the same as the spectrum of hydrogen?
 - Weak Equivalence Principle (WEP):
 - Does antimatter gravitate in the same fashion as normal matter?
- Violation of CPT or WEP would revolutionize fundamental physics.
 - Both CPT and WEP are *very likely* to hold, and yet...

Could CPT Be Violated?

- Physicists have been wrong before...

- P violation---Wolfgang Pauli:¹

"I do not believe that the Lord is a weak left-hander, and I am ready to bet a very high sum that the experiments will give symmetric results."

- CP violation---Lev Landau:²

"If CP is violated, I will hang myself."



Wolfgang Pauli



Richard Feynman

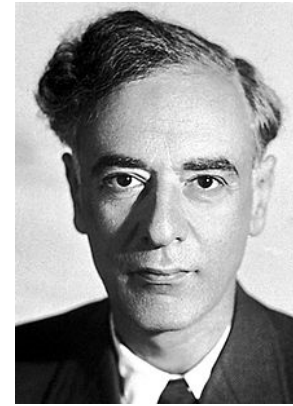

Lev Landau

¹Pauli in a letter to Victor Weisskopf, quoted in the *Ambidextrous Universe*, by Martin Gardner.

²Oral history, as related by Dima Budker.



Plasma Physics and Antihydrogen

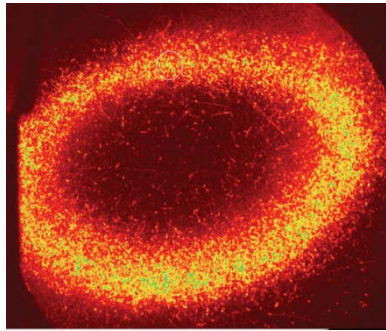

Hollow antiproton plasma
ALPHA 2012

Joel Fajans

U.C. Berkeley

and the **ALPHA** Collaboration

Work supported by:

NSF/DOE Partnership in Basic Plasma Science,

Also supported by CNPq, FINEP/RENAFAE (Brazil), ISF (Israel), MEXT (Japan), FNU and the Carlsberg Foundation (Denmark), VR (Sweden), NSERC, NRC/TRIUMF AIF FQRNT(Canada), and EPSRC, the Royal Society and the Leverhulme Trust (UK).

- Researchers have wished to study the properties of antihydrogen since at least the 1980's.
- Interest in antihydrogen stems from tests of fundamental physics:
 - Charge-Parity-Time (CPT) invariance:
 - Is the spectrum of antihydrogen the same as the spectrum of hydrogen?
 - Weak Equivalence Principle (WEP):
 - Does antimatter gravitate in the same fashion as normal matter?
- Violation of CPT or WEP would revolutionize fundamental physics.
 - Both CPT and WEP are *very likely* to hold, and yet...
- Hints that they might not hold come from the Baryogenesis problem:
 - Why is there so little antimatter in the universe?
- **Nonneutral plasma physics is the key enabling science in the field of antiatom physics.**

Antihydrogen Research History

- 1928: The existence of positrons was predicted in a series of papers by Dirac.
- 1933: The positron was discovered by Anderson at Cal Tech.
- 1955: The antiproton was discovered by Chamberlain, Segrè, Wiegand, and Ypsilantis in Berkeley.
- 1996: Antihydrogen was produced at accelerator scale energies at CERN and at Fermilab (1998).
 - This antihydrogen was too energetic to be used to measure physics properties.
- 2000: Antiprotons were decelerated to 5.3MeV at CERN's new Antiproton Decelerator (AD) facility.
- 2002: Low energy (eV scale) antihydrogen was produced by the ATHENA and ATRAP collaborations at CERN.
 - Hundreds of millions of antiatoms have been made to date.
 - The antihydrogen atoms were untrapped, and lived for a few milliseconds before annihilating on the apparatus walls.
 - Many researchers believe that antiatoms are best studied when trapped, not transitory.



Dirac



Anderson



Bevatron Team

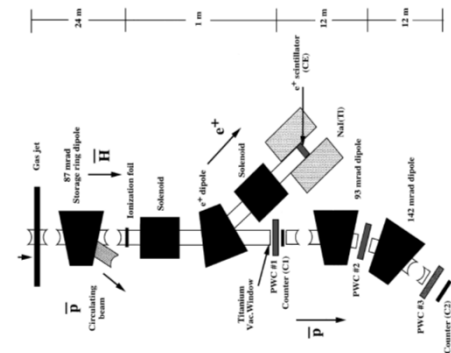

Fermilab Experiment

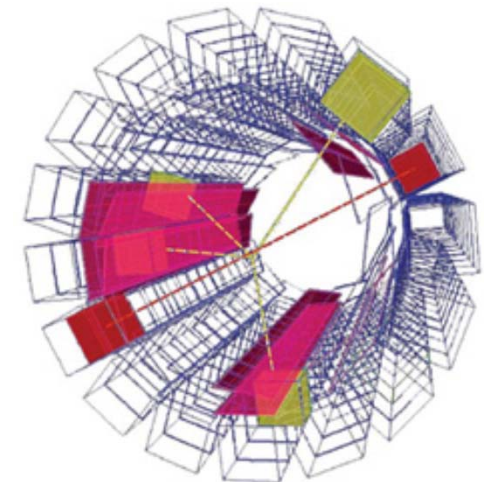

ATHENA Antihydrogen Event

G. Baur, et al, Production of antihydrogen, Phys. Lett. B, **368**, 251 (1996).

G. Blanford, D. C. Christian, K. Gollwitzer, M. Mandelkern, C. T. Munger, J. Schultz, and G. Zioulas, Observation of Atomic Antihydrogen, Phys. Rev. Lett. **80**, 3037 (1998).

ATHENA, Production and detection of cold antihydrogen atoms, Nature **419**, 456 (2002).

ATRAP, Background-free observation of cold antihydrogen with field-ionization analysis of its states, Phys. Rev. Lett. **89**, 213401 (2002).

Antihydrogen Research History

- 2005: Berkeley joined the new ALPHA collaboration, and NSF/DOE partnership funding for antihydrogen plasma research began to have a direct impact.
 - NSF/DOE funding is distributed between Berkeley (JF, Jonathan Wurtele), Auburn/Purdue (Francis Robicheaux), and University of North Texas (Carlos Ordonez).
 - Techniques from the nonneutral plasma community, first funded by ONR and more recently by NSF/DOE, were imported into the antihydrogen field.
- 2010: ALPHA trapped 38 antihydrogen atoms.
 - Progress has been rapid since 2010.
 - ALPHA now can trap about 50 antiatoms in twenty minutes, as opposed to the 38 antiatoms total in 2010.
 - ALPHA has made several significant physics measurements on antihydrogen.

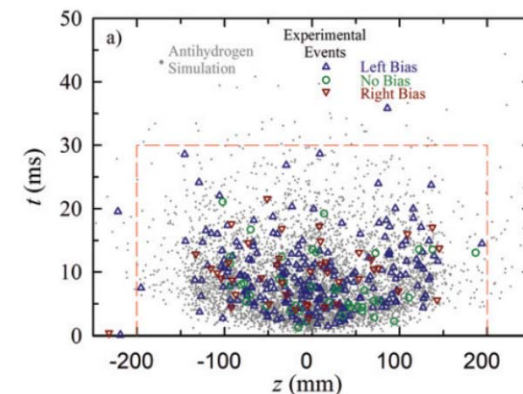

Annihilation Locations of Previously Trapped Antihydrogen Atoms After Release

ALPHA, [Trapped Antihydrogen](#), Nature **468**, 673 (2010).

ALPHA, [Confinement of antihydrogen for 1000s](#), Nature Physics **7**, 558 (2011).

Papers in brick red were principally funded by NSF/DOE. Papers in green have funding from NSF/DOE.

Antihydrogen Physics Measurements

- 2012: ALPHA measured the microwave positron spin flip frequency in antihydrogen.
 - The measurement was accurate to about 0.1%.
 - Our immediate goal is a precision hyperfine splitting measurement.
 - This is a CPT test, and measures the antiproton radius.
- 2013: ALPHA made a “Leaning tower of Pisa” style measurement of the gravitational acceleration of antihydrogen.
 - This initial measurement was crude, setting limits at $\pm 100g$.
 - ALPHA recently received funding from Canada (CFI) and the Carlsberg Foundation to construct an apparatus to measure the acceleration to an accuracy of $\pm 0.01g$.
 - The physics design of this new experiment was done at Berkeley with funding from NSF/DOE.
 - An up/down measurement may be accomplished by 2018.
- 2014: ALPHA measured the charge of antihydrogen.
 - In 2016 this measurement is improved to the 1ppb level, and is the first precision measurement performed on antihydrogen.
 - The measurement also sets a limit on the charge of the positron.

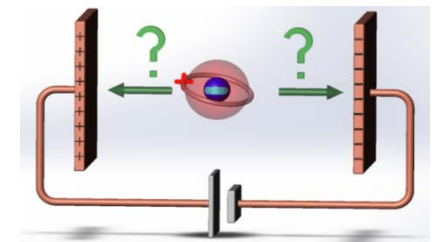
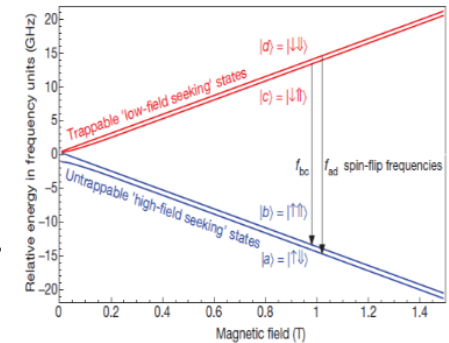

ALPHA, [Resonant quantum transition in trapped antihydrogen atoms](#), Nature **483**, 439 (2012).

ALPHA, [Description and first application of a new technique to measure the gravitational mass of antihydrogen](#), Nature Comm **4**, 1785 (2013).

A I Zhmoginov, A E Charman, R Shalloo, J Fajans, J S Wurtele, [Nonlinear dynamics of anti-hydrogen in magnetostatic traps: implications for gravitational measurements](#), Class. and Quantum Grav., **30** 205014 (2013).

ALPHA, [An experimental limit on the charge of antihydrogen](#), Nature Comm, **5**, 3955 (2014).

M. Baquero-Ruiz, A. E. Charman, J. Fajans, A. Little, A. Povilus, F. Robicheaux, J.S. Wurtele and A. I. Zhmoginov, [Measuring the electric charge of antihydrogen by stochastic acceleration](#), New J. Phys. **16** 083013, (2014).

ALPHA, [An improved limit on the charge of antihydrogen from stochastic acceleration](#), Nature, **529**, 373 (2016).

Antihydrogen Physics Measurements

- 2016: ALPHA measured 1s-2s transition energy of antihydrogen with 243nm light.
 - Measurement is only on/off resonance, but suggests a precision of 200ppt.
 - Loosely, this is within a factor of four on an absolute energy scale of the best CPT test (neutral kaon system) that has been performed to date.
 - We expect to be able to measure a complete 1s-2s spectrum this year to perhaps 5ppt.
 - If accomplished, this will be the leading CPT test.

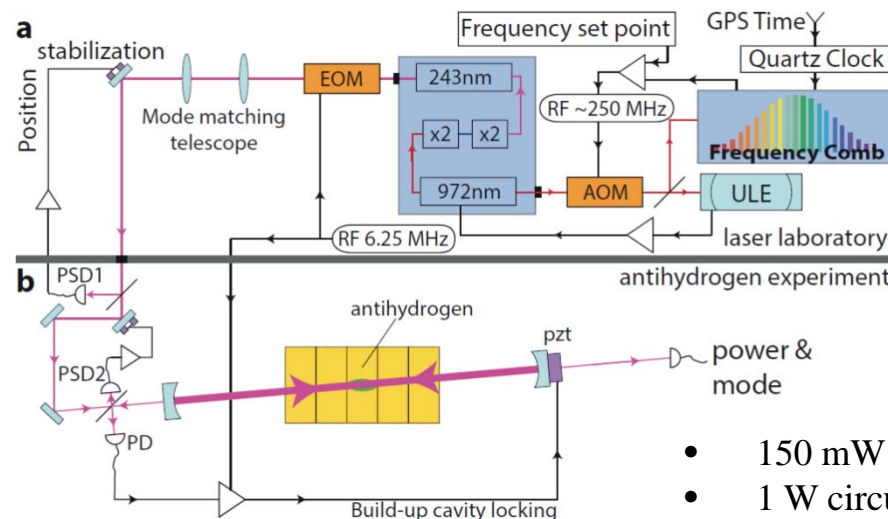

- 150 mW at 243 nm
- 1 W circulating in cavity

Connection to Plasma Physics

- Antihydrogen is synthesized by mixing antiproton and positron plasmas in a Penning-Malmberg trap.
 - A strong axial magnetic field provides radial confinement.
 - Potentials applied to electrically-isolated electrodes provides axial confinement.
 - The plasmas $E \times B$ spin in the external magnetic and the self-consistent electric fields.

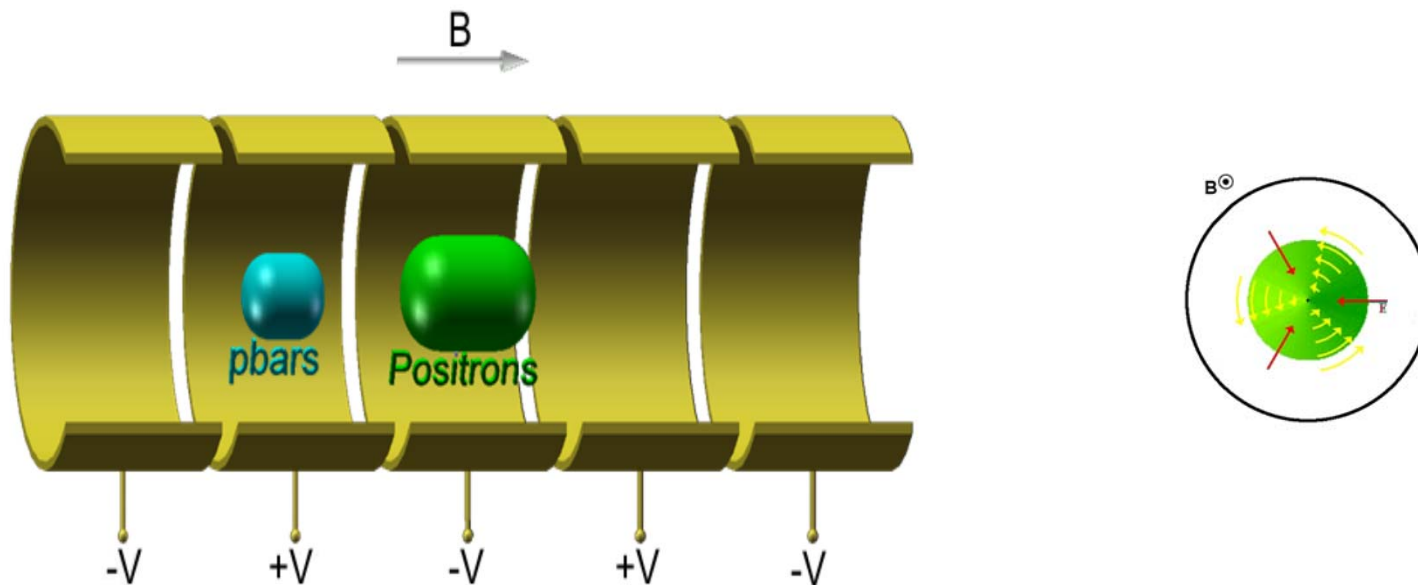

Connection to Plasma Physics

- Antihydrogen is synthesized by mixing antiproton and positron plasmas in a Penning-Malmberg trap.
 - The positrons come from a Surko-style positron accumulator.
 - Positron plasma parameters:
 - $N = 20M$
 - $r = 1mm$
 - $L = 10mm$
 - $n = 10^8 \text{ cm}^{-3}$
 - $T = 10K$
 - The antiprotons come from the AD at CERN.
 - Antiproton plasma parameters:
 - $N = 20k$
 - $r = 1mm$
 - $T = 100K$
- Once these plasmas are made, they are mixed together, and antihydrogen forms by three-body recombination.
- Antihydrogen is charge neutral, so it is not trapped by the Penning-Malmberg trap fields, and would annihilate on the trap wall without additional magnetic fields.

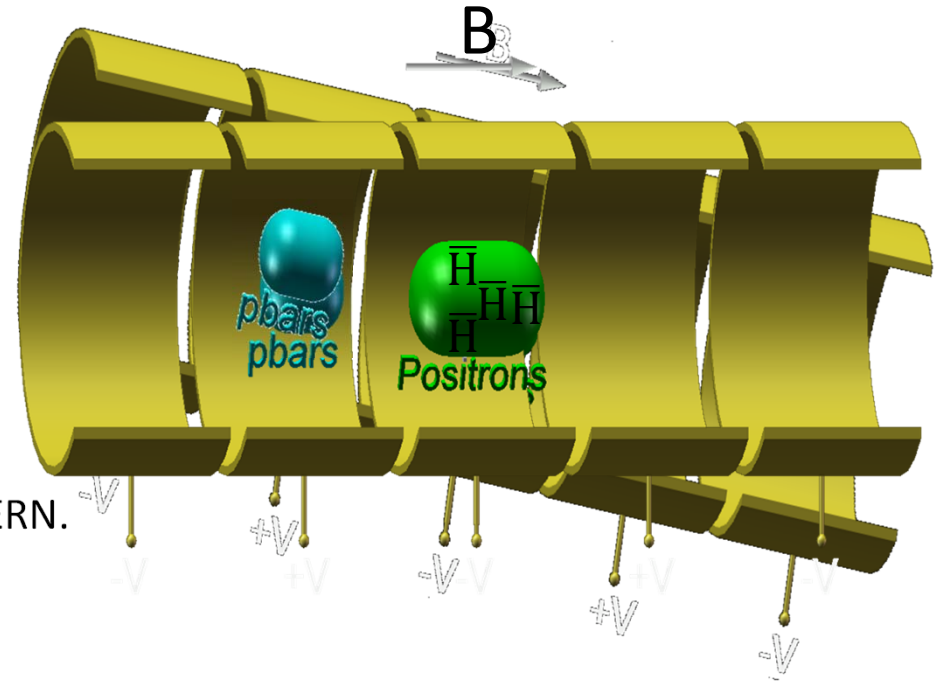

Plasma Manipulations

- Preparing the antiproton and positron plasmas for antihydrogen trapping takes five to ten minutes.
- Hundreds of individually planned “gross” potential changes are required.
- These gross changes result in tens of millions of potential change commands.
- The currents of nine high-field magnets are manipulated.

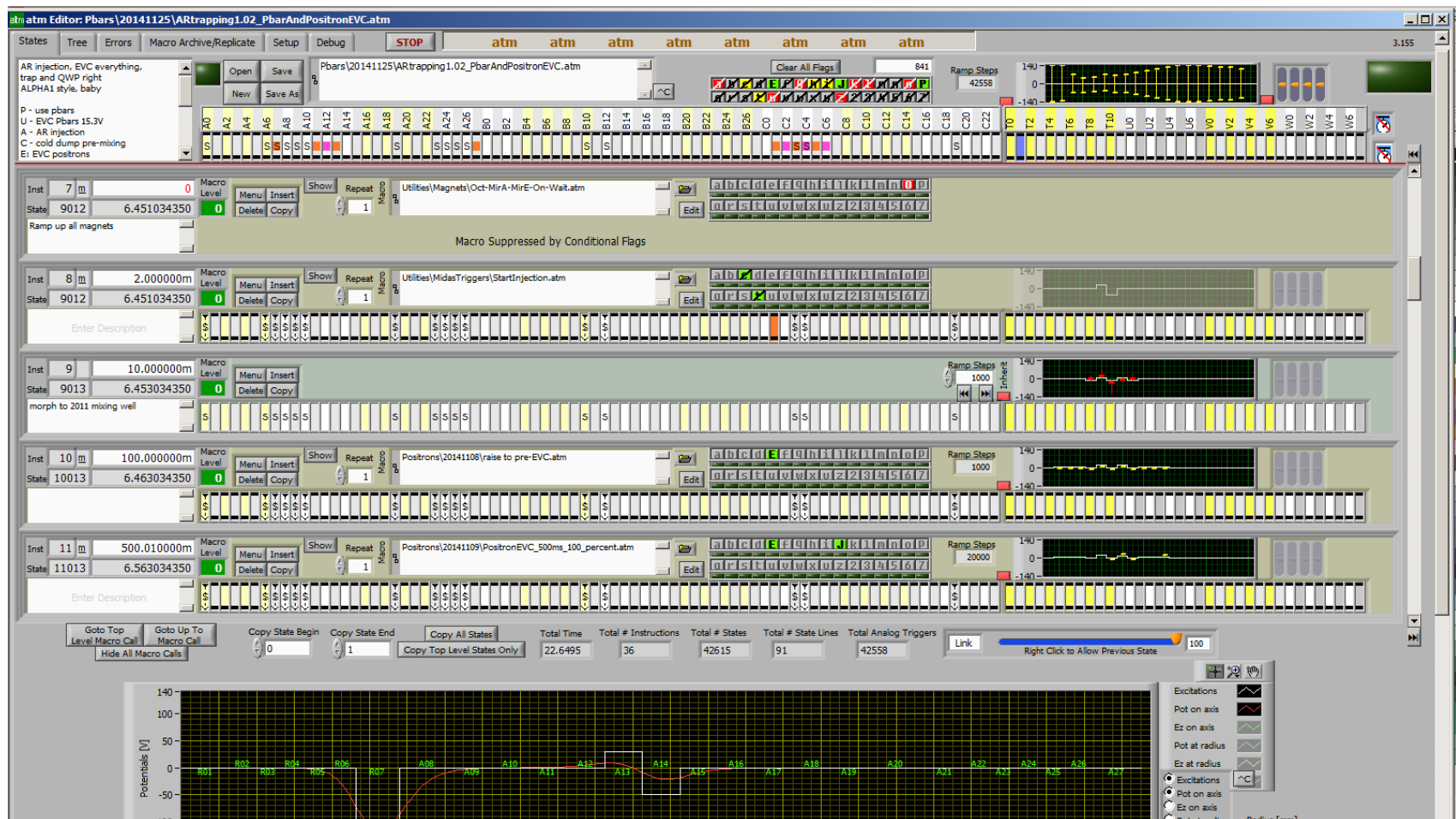

Connection to Plasma Physics

- Creating the necessary plasma condition makes up the bulk of our experimental effort.
- **The principle difficulties in optimizing the trapping of antihydrogen come from plasma physics issues.**
 - Key areas of concern:
 - Creating plasmas of the correct radius, length, number and density.
 - Removing electrons from mixed antiproton-electron plasmas without perturbing the remaining antiprotons.
 - Minimizing plasma expansion.
 - **Minimizing plasma temperatures.**
 - **Optimally mixing positron and antiproton plasmas.**
 - **Reproducibility, reproducibility, reproducibility.**

Plasma and Nonlinear Dynamics papers funded by the NSF/DOE antihydrogen grant

J. Fajans, W. Bertsche, K. Burke, S.F. Chapman, D.P. van der Werf, [Effects of extreme magnetic quadrupole fields on Penning Traps, and the consequences for antihydrogen trapping](#), Phys. Rev. Lett., **95**, 155001, (2005).

ALPHA, [A magnetic trap for Antihydrogen confinement](#), Nucl. Instr. Meth. Phys. Res. A **566**, 746, (2006).

J. Zhang, C. L. Taylor, J. D. Hanson, and F. Robicheaux, [Regular and chaotic motion of anti-protons through a nested Penning trap with multipole magnetic fields](#), J. Phys. B **40**, 1019 (2007).

F. Robicheaux and J. Fajans, [Thermalization of magnetized electrons from black body radiation](#), J. Phys. B **40**, 3143 (2007).

ALPHA, [Antimatter plasmas in a multipole trap for Antihydrogen](#), Phys. Rev. Lett., **98**, 023402, (2007).

K. Gomberoff, J. Fajans, J. Wurtele, A. Friedman, D.P. Grote, R.H. Cohen, and J.-L. Vay, [Simulations of plasma confinement in an antihydrogen trap](#), Phys. Plasmas, **14** 102111, (2007).

C. A. Ordonez, [Effect of Positron Space Charge on Operation of an Antihydrogen Trap](#), Phys. Rev. E **76**, 017402 (2007).

C. A. Ordonez and J. R. Correa, [Antiproton Cross-Field Diffusion in Antihydrogen Production Experiments Due To Anisotropic Binary Interactions](#), Nucl. Instrum. Meth. B **261**, 248 (2007).

Y. Ahat, C. E. Correa, and C. A. Ordonez, [Positron Cross-Field Transport Due To Quasibound States of Antihydrogen](#), Nucl. Instrum. Meth. B **261**, 252 (2007).

J. Fajans, N. Madsen, and F. Robicheaux, [Critical loss radius in a Penning trap subject to multipole fields](#), Phys. Plasmas **15**, 032108 (2008).

J.L. Hurt, P.T. Carpenter, C.L. Taylor, and F. Robicheaux, [Positron and electron collisions with anti-protons in strong magnetic fields](#), J. Phys. B **41**, 165206 (2008).

ALPHA, [Production of antihydrogen at reduced magnetic field for anti-atom trapping](#), J. Phys. B: At. Mol. Opt. Phys. **41** 011001, (2008).

ALPHA, [A novel antiproton radial diagnostic based on octupole induced ballistic loss](#), Phys. Plasmas, **15**:032107, (2008).

ALPHA, [Compression of antiproton clouds for antihydrogen trapping](#), Phys. Rev. Lett., **100**:203401, (2008).

C. A. Ordonez and D. L. Weathers, [Two-Species Mixing in a Nested Penning Trap for Antihydrogen Trapping](#), Phys. Plasmas **15**, 083504 (2008).

C. A. Ordonez, [Charged Particle Transport Through a Periodic Electrostatic Potential Having a Small Spatial Period](#), J. Appl. Phys. **104**, 054903 (2008).

C. A. Ordonez, [Effect of a Periodic Electrostatic Potential on Magnetized Particle Transport](#), Phys. Plasmas **15**, 114507 (2008).

S. Jonsell, D.P. van der Werf, M. Charlton, and F. Robicheaux, [Simulation of the formation of antihydrogen in a nested Penning trap: effect of positron](#), J. Phys. B **42**, 215002 (2009).

ALPHA, [Magnetic Multiple Induced Zero-Rotation Frequency Bounce-Resonant Loss in a Penning-Malmberg Trap Used For Antihydrogen Trapping](#), Phys. Plasmas, **16** 100702, 2009.

ALPHA, [Antiproton, Positron, and Electron Imaging with a Microchannel Plate/Phosphor Detector](#), Rev. Sci. Instr., **80**, 123701, (2009).

C. A. Ordonez, [Charged Particle Reflection From an Artificially Structured Boundary That Produces a Spatially Periodic Magnetostatic Field](#), J. Appl. Phys. **106**, 024905 (2009).

ALPHA, [Antihydrogen formation dynamics in a multipolar neutral anti-atom trap](#), Phys. Lett B, **685**, 141, (2010).

ALPHA, [Evaporative Cooling of Antiprotons to Cryogenic Temperatures](#), Phys. Rev. Lett., **105** 013003, (2010).

C. A. Ordonez, [Drifting Plasma Confinement With a Spatially Periodic Field](#), IEEE Trans. Plasma Sci. **38**, 388 (2010).

ALPHA, [Autoresonant excitation of antiproton plasmas](#), Phys. Rev. Lett., **106** 025002 (2011).

ALPHA, [Centrifugal separation and equilibration dynamics in an electron-antiproton plasma](#), Phys. Rev. Lett., **106** 145001, (2011).

J. L. Pacheco, C. A. Ordonez, and D. L. Weathers, [Plasma Interaction With a Static Spatially Periodic Electromagnetic Field](#), IEEE Trans. Plasma Sci. **39**, 2424 (2011).

ALPHA, [Discriminating between antihydrogen and mirror-trapped antiprotons in a minimum-B trap](#), New J. Phys., **14** 015010, (2012).

J. L. Pacheco, C. A. Ordonez, and D. L. Weathers, [Space-Charge-Based Electrostatic Plasma Confinement Involving Relaxed Plasma Species](#), Phys. Plasmas **19**, 102510 (2012).

ALPHA, [Experimental and computational study of the injection of antiprotons into a positron plasma for antihydrogen production](#), Physics of Plasmas **20**, 043510, (2013).

ALPHA, [Autoresonant-spectrometric determination of the residual gas composition in the ALPHA experiment apparatus](#), Rev. Sci. Instr., **84** 065110, (2013).

ALPHA, [Description and first application of a new technique to measure the gravitational mass of antihydrogen](#), Nature Comm **4**, 1785 (2013).

A I Zhmoginov, A E Charman, R Shaloo, J Fajans, J S Wurtele, [Nonlinear dynamics of anti-hydrogen in magnetostatic traps: implications for gravitational measurements](#), Class. and Quantum Gra v., **30** 205014 (2013).

N. Madsen, F. Robicheaux, and S. Jonsell, [Antihydrogen trapping assisted by sympathetically cooled positrons](#), New J. Phys. **16**, 063046 (2014).

B. Radics, D.I. Murtagh, Y. Yamazaki, and F. Robicheaux, [Scaling behavior of the ground-state antihydrogen yield as a function of positron density and temperature from classical-trajectory Monte Carlo simulations](#), Phys. Rev. A **90**, 032704 (2014).

ALPHA, [In situ electromagnetic field diagnostics with an electron plasma in a Penning-Malmberg Trap](#), New J. Phys. **16** 013037, (2014).

R. A. Lane and C. A. Ordonez, [Classical Trajectory Monte Carlo Simulations of Particle Confinement Using Dual Levitated Coils](#), AIP Adv. **4**, 077117 (2014).

A. S. Kiestler, J. L. Pacheco, C. A. Ordonez, and D. L. Weathers, [Phase Space of Positron Trajectories Exiting a Charged Particle Source Through a Magnetic Field Point Cusp](#), Nucl. Instrum. Meth. B **332**, 401 (2014).

ALPHA, [An experimental limit on the charge of antihydrogen](#), Nature Comm, **5**, 3955 (2014).

M. Baquero-Ruiz, A. E. Charman, J. Fajans, A. Little, A. Povilus, F. Robicheaux, J.S. Wurtele and A. I. Zhmoginov, [Measuring the electric charge of antihydrogen by stochastic acceleration](#), New J. Phys. **16** 083013, (2014).

F. F. Aguirre and C. A. Ordonez, [Giant Cross-Magnetic-Field Steps Due to Binary Collisions Between Pair Particles](#), Phys. Rev. E **91**, 033103 (2015).

F. F. Aguirre and C. A. Ordonez, [Radial Expansion of a Low Energy Positron Beam Passing Through a Cold Electron Plasma within a Uniform Magnetic Field](#), Phys. Procedia **66**, 52 (2015).

ALPHA, [An improved limit on the charge of antihydrogen from stochastic acceleration](#), Nature, **529**, 373 (2016).

A.P. Povilus, N.D. DeTal, L.T. Evans, N. Everts, J. Fajans, W.N. Hardy, E.D. Hunter, I. Martens, F. Robicheaux, S. Shanman, C. So, X. Wang, and J.S. Wurtele, [Electron Plasmas Cooled by Cyclotron-Cavity Resonance](#), Phys. Rev. Lett. **117**, 175001 (2016).

R. A. Lane and C. A. Ordonez, [Confinement of Antiprotons in the Electrostatic Space Charge of Positrons in a Model of the Alpha Antihydrogen Trap](#), J. Phys. B **49**, 074008 (2016).

Antihydrogen Trapping

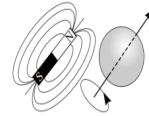

- Antihydrogen has a small magnetic moment.
- Consequently, antihydrogen can be confined in a magnetic minimum.
 - Mirror coils can be used to create an axial minimum.
 - Multipole (quadrupole, octupole etc.) coils can be used to create a radial minimum.
- ***These magnetic fields impact plasma confinement.***

Force on a magnet moment from a magnetic gradient:

$$\mathbf{F} = \nabla(\boldsymbol{\mu} \cdot \mathbf{B})$$

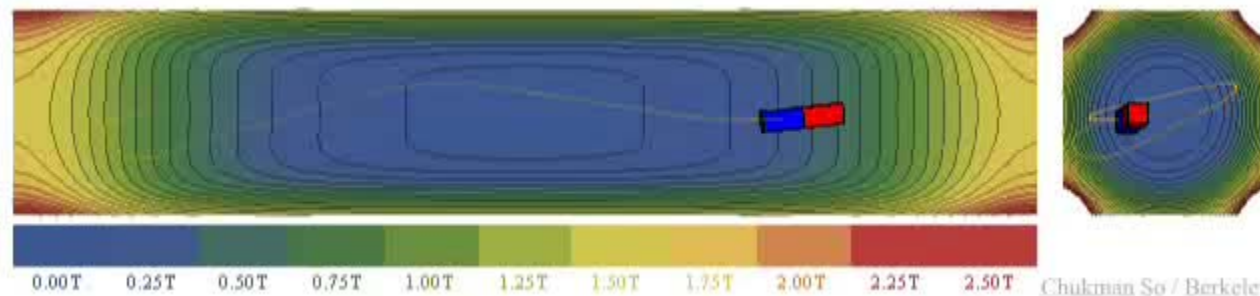

Magnetic Field Magnitude

Retaining the Plasmas

- Multipole azimuthal asymmetries violate O'Neil's plasma confinement theorem:

$$L \approx (B/2) \sum_j q_j r_j^2 = \text{const.}$$

- Increasing the multipole order sharply decreases the field-plasma interaction.
- Decreasing the plasma radius diminishes the interaction between the multipole fields and the plasmas.

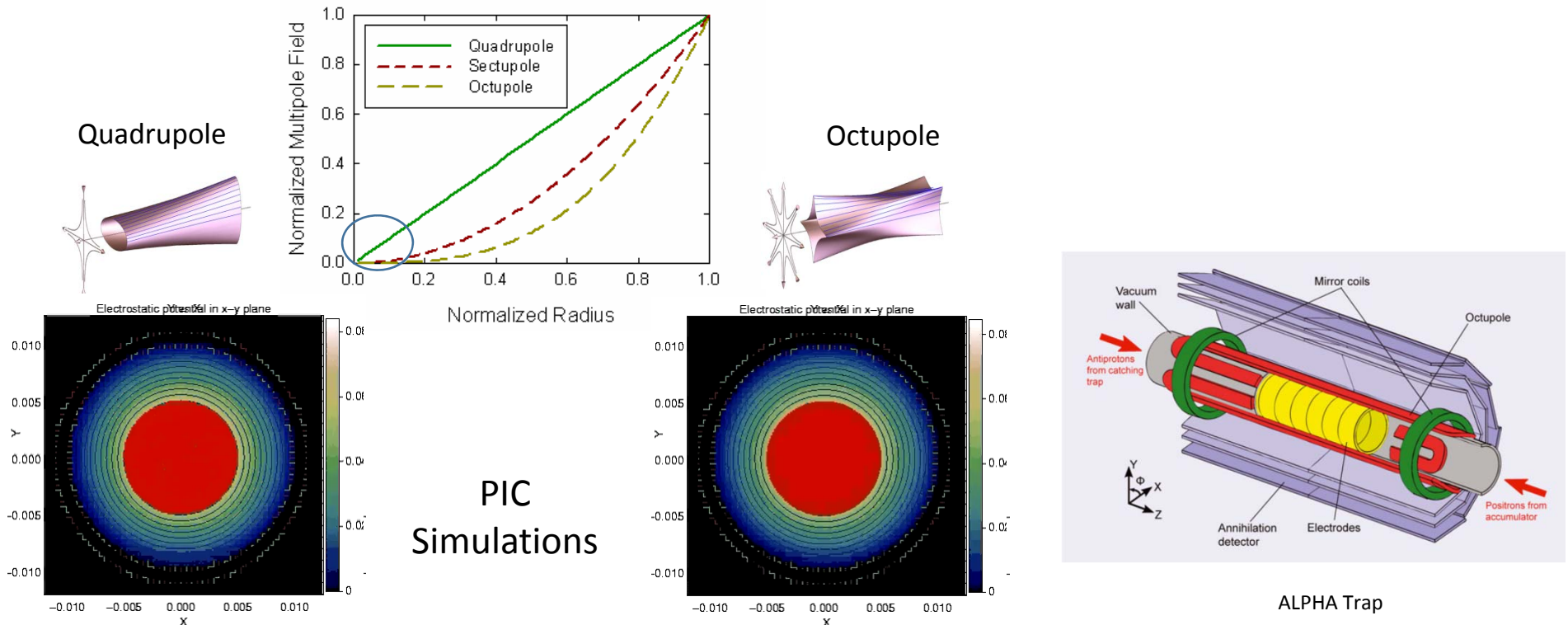

- The need for plasma stability drove the most fundamental aspects of the ALPHA trap.**

T.M. O'Neil, [A Confinement Theorem for Nonneutral Plasmas](#), *Phys. Fluids* 23, 2216 (1980).

E. Gilson and J. Fajans, [Quadrupole induced resonant particle transport in a pure-electron plasma](#), *Phys. Rev. Lett.*, **90**: 015001, 2003.

J. Fajans and A. Schmidt, [Malmberg-Penning and Minimum-B Trap compatibility: the advantages of higher-order multipole traps](#), *NIM A*, **521**: 318, 2004.

J. Fajans, W. Bertsche, K. Burke, S.F. Chapman, D.P van der Werf, [Effects of extreme magnetic quadrupole fields on Penning Traps, and the consequences for antihydrogen trapping](#), *Phys. Rev. Lett.* **95**, 155001, (2005).

K. Gomberoff, J. Fajans, J. Wurtele, A. Friedman, D.P. Grote, R.H. Cohen, and J.-L. Vay, [Simulations of plasma confinement in an antihydrogen trap](#), *Phys. Plasmas*, **14** 102111, (2007).

J. Fajans, N. Madsen and F. Robicheaux, [Critical loss radius in a Penning trap subject to multipole fields](#), *Phys. Plasmas*, **15** 032108, (2008).

Multipole Fields

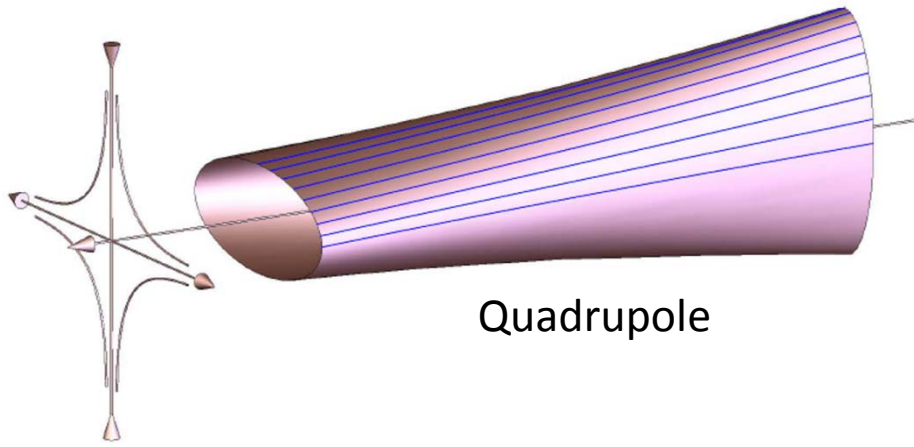

Quadrupole

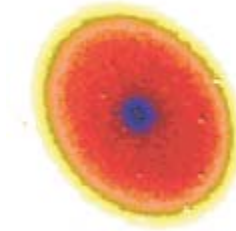

E. Gilson and J. Fajans, *Phys. Rev. Lett.*, **90**: 015001, 2003.

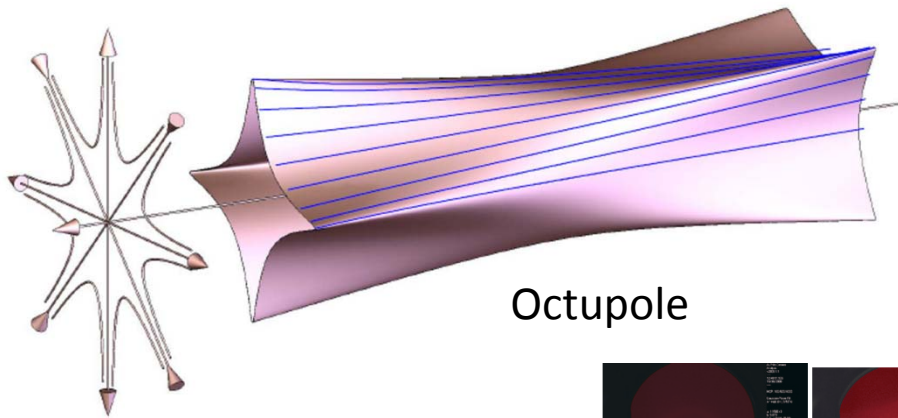

Octupole

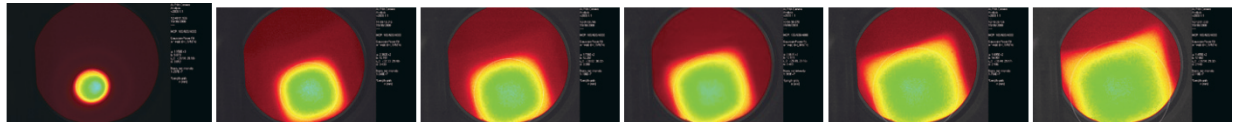

ALPHA 2008

Octupole Induced Antiproton Loss

Losses are observed with long, fat plasmas...
but there are no loss with short, thin plasmas.

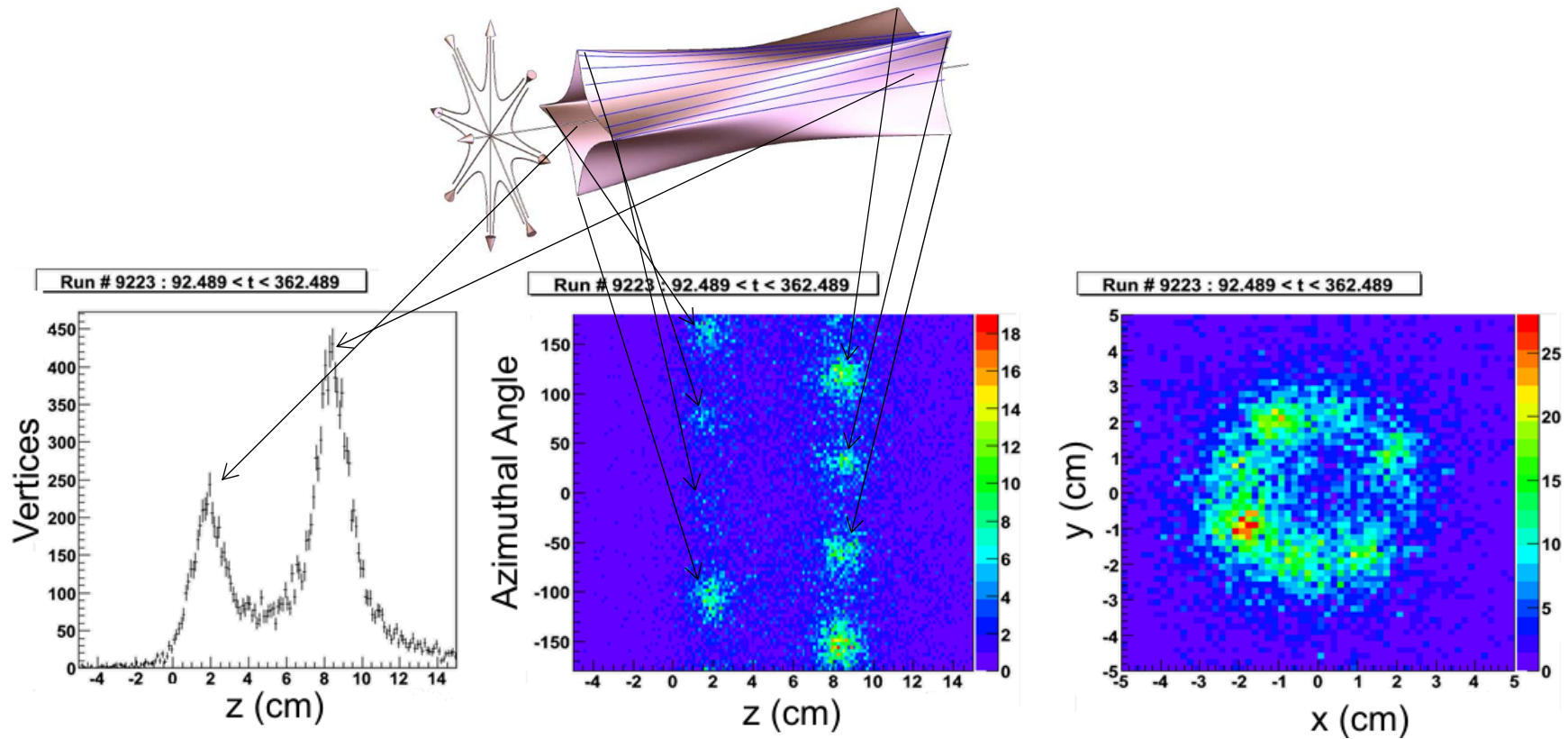

J. Fajans, W. Bertsche, K. Burke, S.F. Chapman, D.P van der Werf, Effects of extreme magnetic quadrupole fields on Penning Traps, and the consequences for antihydrogen trapping, *Phys. Rev. Lett.* **95**, 155001, 2005.

ALPHA, Antimatter plasmas in a multipole trap for Antihydrogen, *Phys. Rev. Lett.*, **98**: 023402, 2007.

ALPHA 2009

Antiproton Compression

- Some electrodes are azimuthally sectored.
- Applying rotating voltages to the sectors creates a rotating electric field.
- This field applies a torque to the plasma, changing the angular momentum $L \approx (B/2) \sum_j q_j r_j^2$, and compressing the plasma.

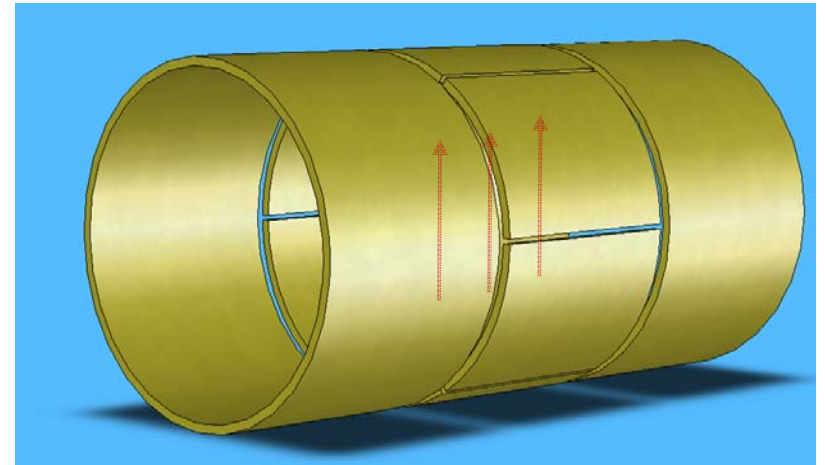

- This is a commonly used, but not entirely understood, technique for manipulating the radial profiles of nonneutral plasmas.

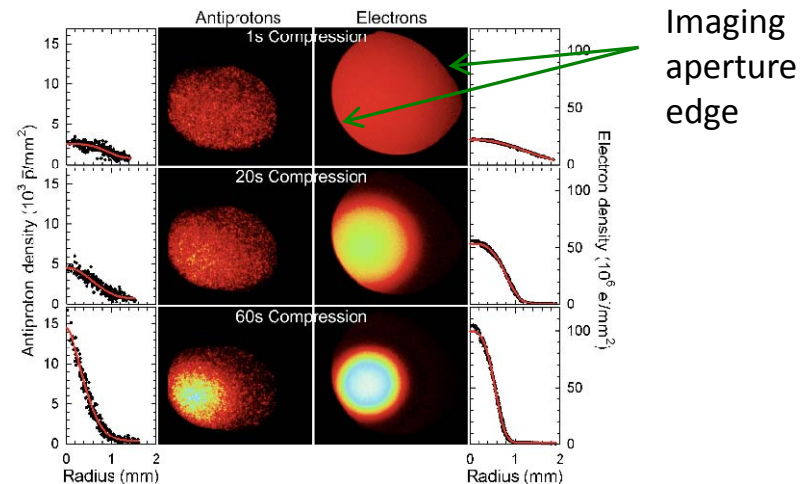

X.-P. Huang, F. Anderegg, E. M. Hollmann, C. F. Driscoll, and T. M. O'Neil, Phys. Rev. Lett. 78, 875 (1997).

R. G. Greaves and C. M. Surko, Phys. Rev. Lett. 85, 1883 (2000).

ALPHA, [Compression of antiproton clouds for antihydrogen trapping](#), Phys. Rev. Lett, **100**:203401, (2008).

ASACUSA [Radial compression of an antiproton cloud for production of intense antiproton beams](#), Phys. Rev. Lett., **100** 203402 (2008).

Centrifugal Separation

- The electron/antiproton cloud rotates around the trap axis.

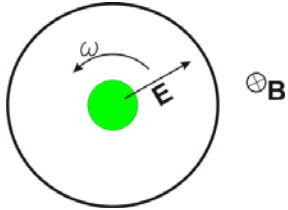

- The antiprotons, being heavier than the electrons, get pushed to the outside.

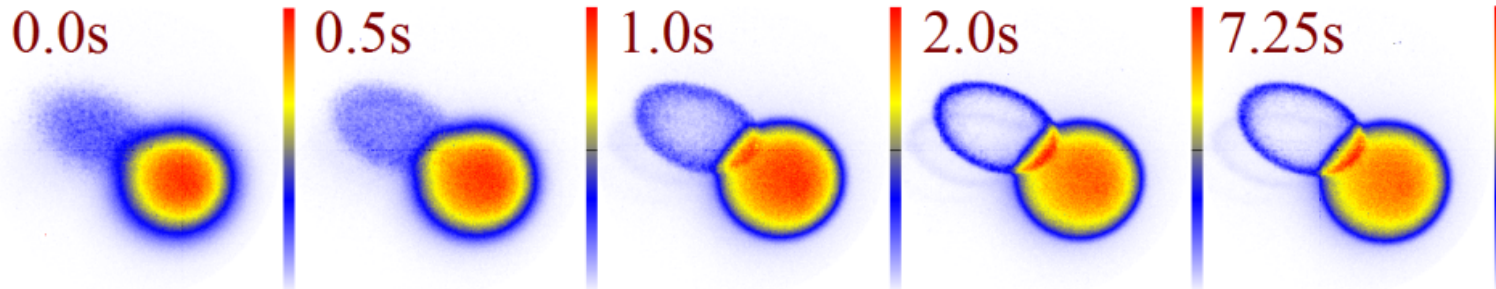
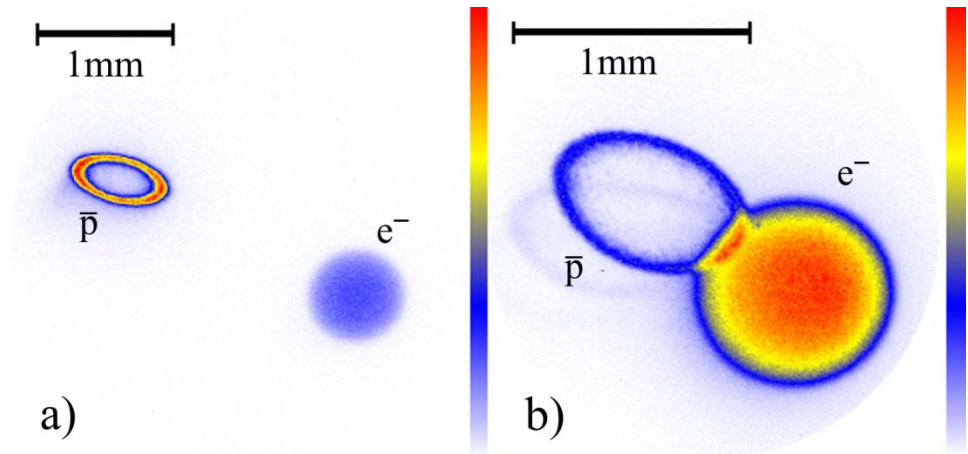

T. M. O'Neil, Phys. Flu. **24**, 1447 1981.

D. J. Larson, J.C. Berquist, J. J. Bollinger, W. M. Itano, and D. J. Wineland, Phys. Rev Lett **57**, 70 1986.

ALPHA, [Centrifugal separation and equilibration dynamics in an electron-antiproton plasma](#), PRL **106**, 145001 2011.

Antihydrogen Trap

- Our octupole is a state-of-the art superconducting magnet fabricated at the Brookhaven National Lab.

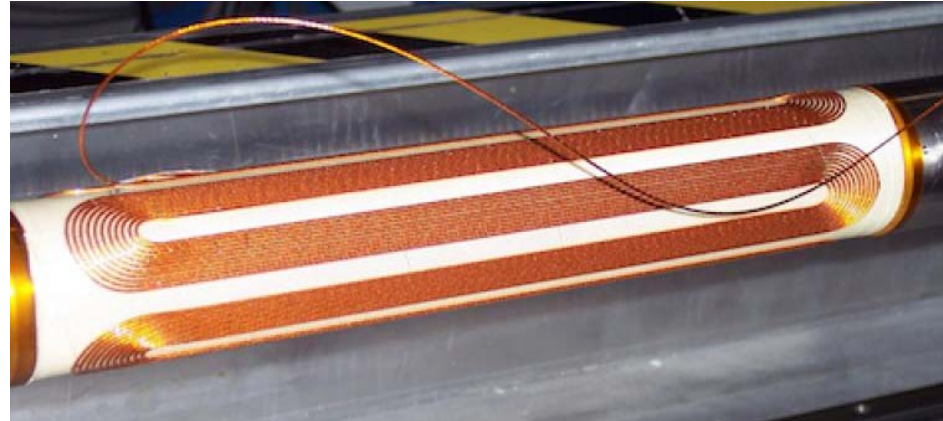

- The octupole produces a maximum field of $\sim 1.54\text{T}$.
- Unfortunately, the magnetic moment of (anti)hydrogen is weak.
 - The octupole creates a well depth of only about $\sim 0.54\text{K}$, or $40\mu\text{eV}$.
- The natural energy scale of the mixing process is the plasma potential, which is on the order of a $\sim 11000\text{K}$, or 1eV .
 - We need to create antihydrogen at an energy of less than $40\mu\text{eV}$ for it to be trapped.
- Producing very cold antihydrogen requires very cold positrons.

Positron Temperature (K)	Antiproton Temperature (K)	Rate	
		Antiatoms/Attempt Measured	Predicted
71	360	0.03	
40	200	0.12	
40	100	0.75	
15	†		2
10	†		4
4	†		11

Lepton Cooling

- Positrons cool by cyclotron radiation.
 - At 1T, the predicted cooling time is 3.8s.

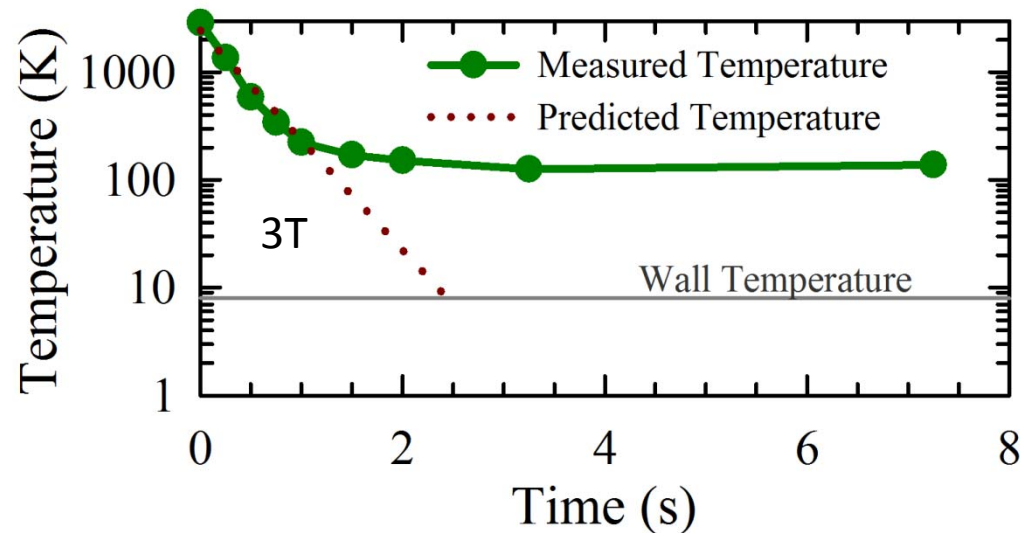

- The particles should cool to the temperature of the surrounding walls...but they don't.
 - Typical final temperature is $\sim 100\text{K}$, observed across many experiments.
- The mechanisms that arrest the cooling are not well understood.
 - Amplifier noise.
 - Higher temperature black body radiation “leaking” into the mixing region.
 - Asymmetry driven expansion.

Expansion Heating

- Nonneutral plasmas inevitably expand.
- As the plasmas expand, they do work on themselves, converting electrostatic energy to kinetic energy.
- **Expansion leads to self-heating.**
- The octupole drives expansion because it breaks the azimuthal symmetry.
 - Reducing the radius of the plasma reduces the effects of the octupole.

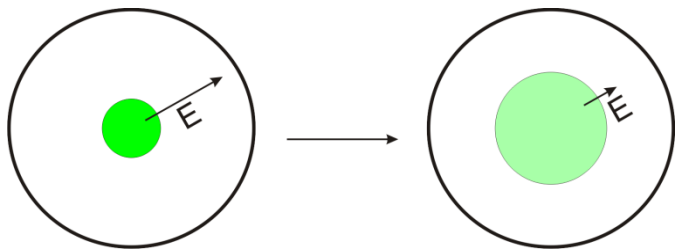
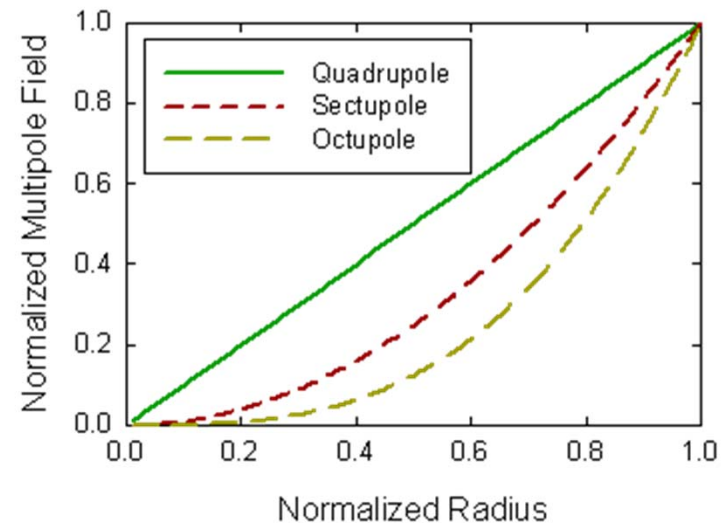

Positron Evaporative Cooling

- We need temperatures well below 100K.

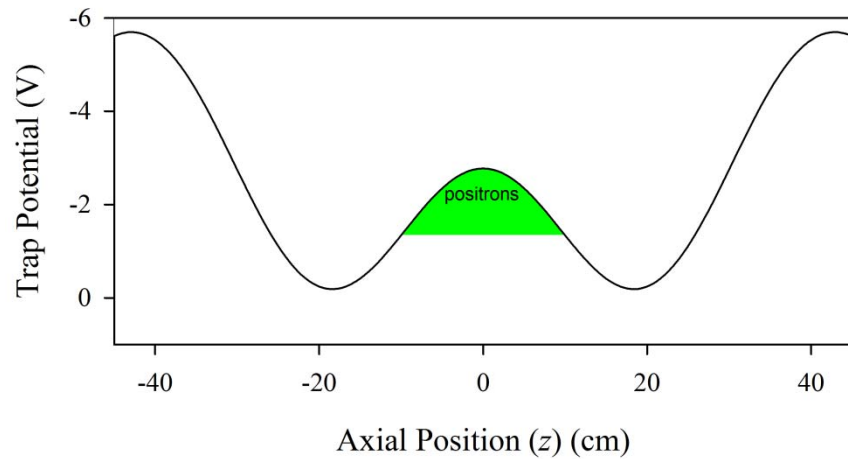
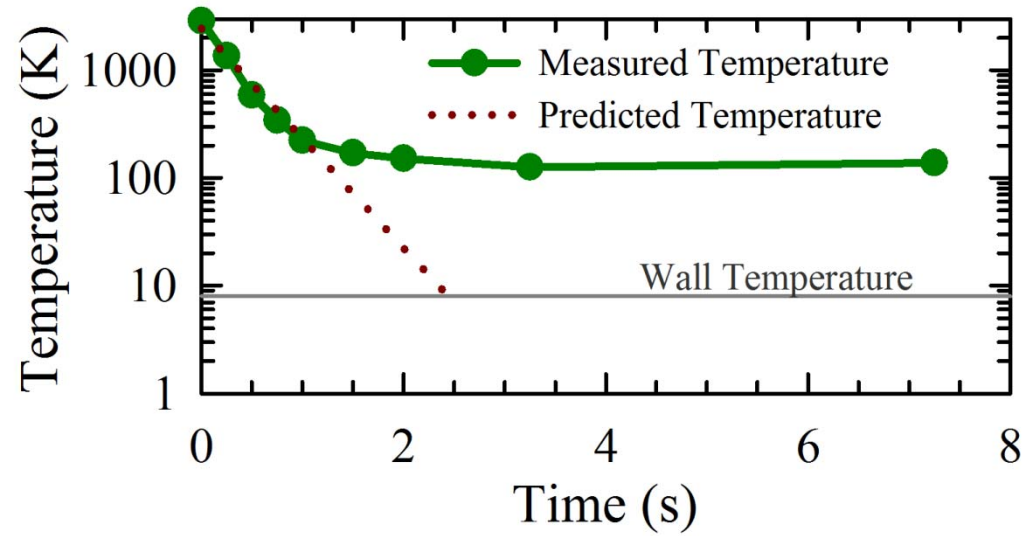

Positron Evaporative Cooling

- We need temperatures well below 100K.
- By making the positron well very shallow on one side, we allow the hottest positrons to escape.
 - This cools the remaining positrons.
 - Typically, we can get to $\sim 10\text{K}$ temperatures.
- This is a temporary effect; after evaporative cooling, the positrons quickly warm back up.
 - Consequently, we need to use the cold positrons quickly.
 - This sets constraints on our positron-antiproton mixing procedures.

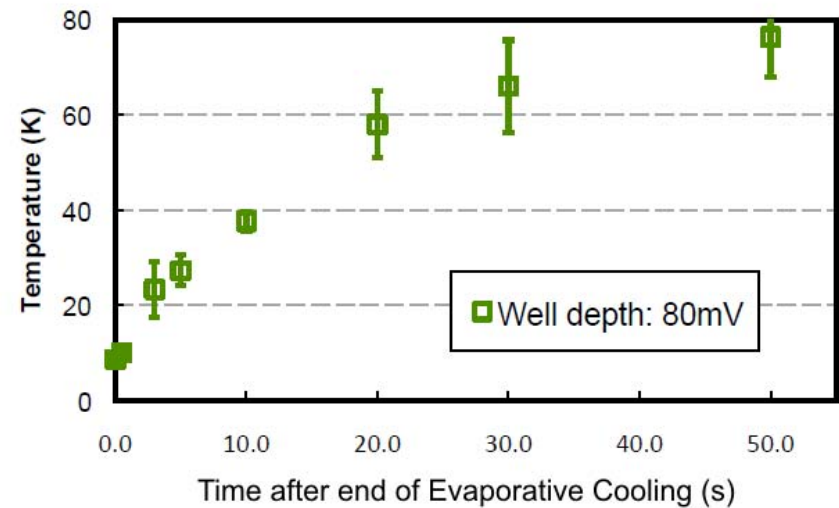
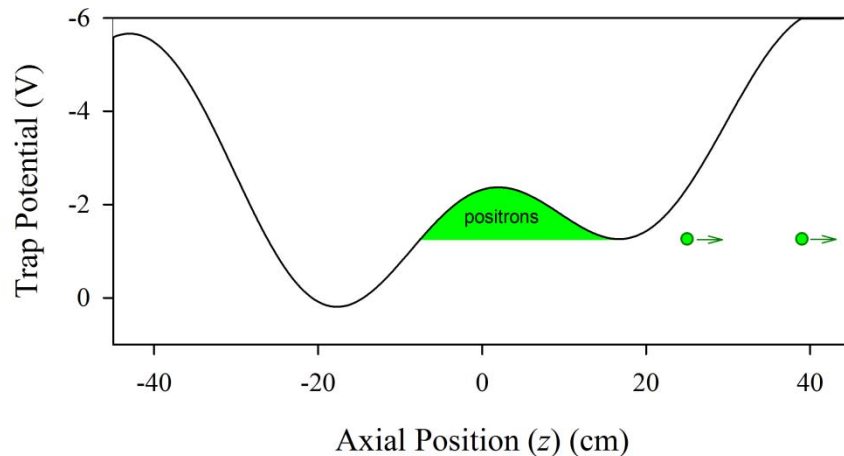

ALPHA, 2010

Cavity Cooling

- Recently, we have been exploring cavity cooling in Berkeley.
- Noninteracting leptons are known to undergo enhanced cooling in cavities.
 - Cooling of equilibrium plasmas had never been observed directly.

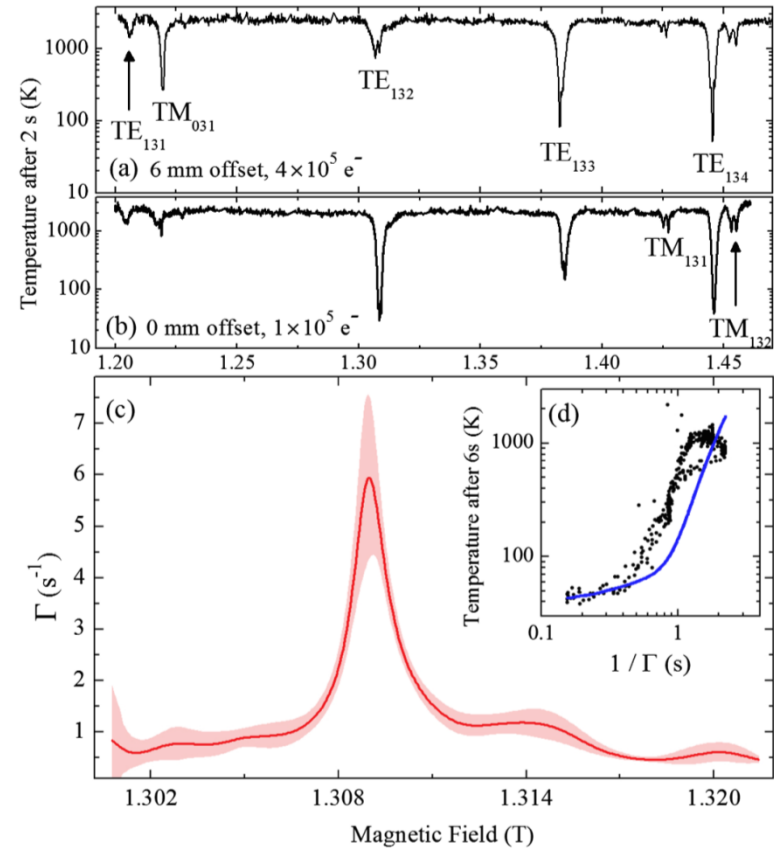
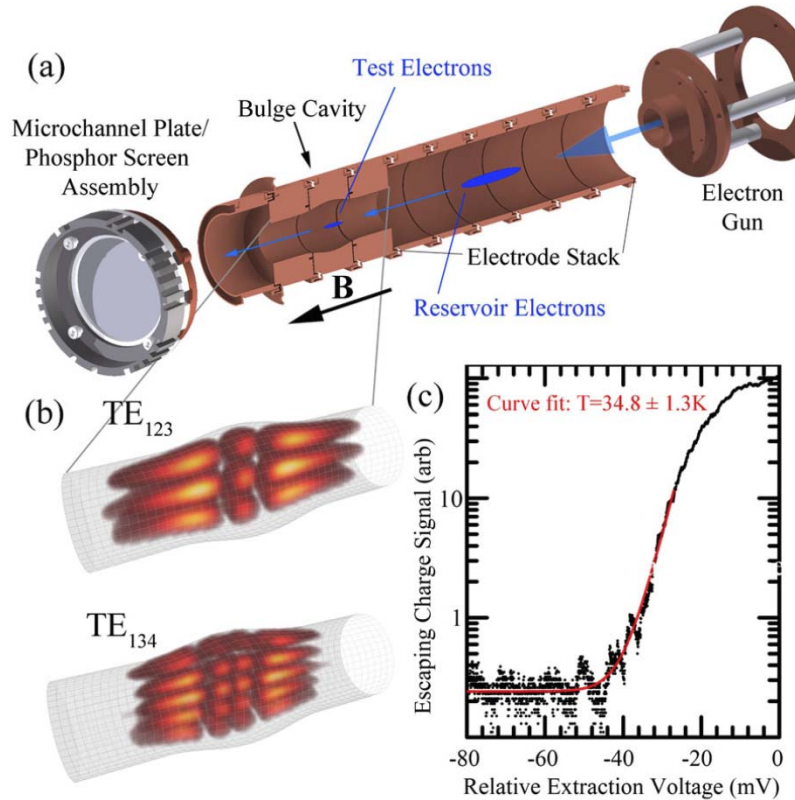

- Cooling is sometimes best near a cavity node.

A.P Povilus, N.D. DeTal, L.T. Evans, N. Evetts, J. Fajans, W.N. Hardy, E.D. Hunter, I. Martens, F. Robicheaux, S. Shanman, C. So, X. Wang and J.S. Wurtele, [Electron plasmas cooled by cyclotron-cavity resonance](#), Phys. Rev Lett. **117**, 175001 (2016).

A. Povilus, Ph.D. thesis, Berkeley (2015).

L. Evans, Ph.D. thesis, Berkeley (2016).

E. Hunter, Ph.D. thesis in preparation, Berkeley.

Plasma Stability and Reproducibility

- It is possible for the plasma rotation to lock to a rotating wall drive.
 - This is called the Strong Drive Regime (SDR).

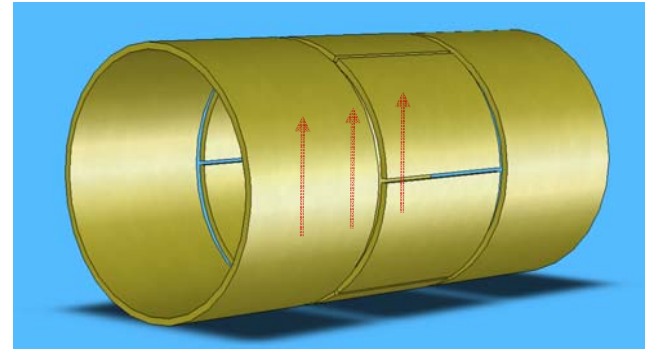
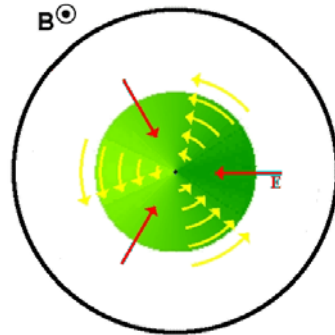

- Since the plasma rotation frequency is proportional to the plasma density n , this locks the density to the drive frequency in SDR.
- The plasma central potential is, in the zero temperature limit, given by:

$$\Phi = \frac{ner_p^2}{2\epsilon_0} \left[1 + \ln \frac{R_W}{r_p} \right].$$

- Evaporative cooling (EVC) sets the central potential Φ .
- If SDR and EVC are applied simultaneously, there is only one plasma radius r_p , and one total charge N , that meets the n and Φ constraints.
 - Thus, the plasma parameters are locked.

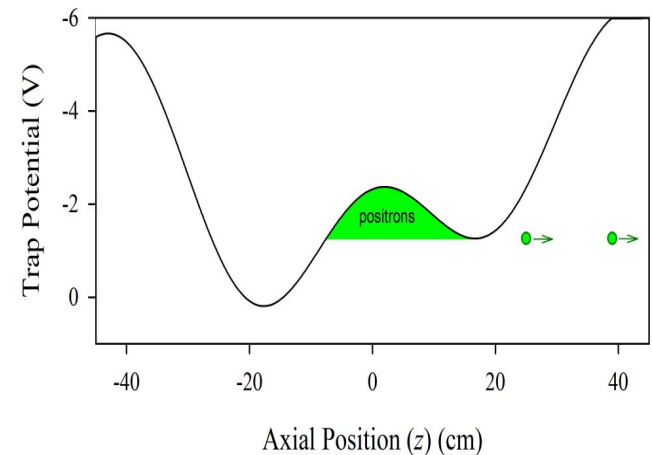

J. R. Danielson and C. M. Surko, Torque-Balanced High-Density Steady States of Single-Component Plasmas, Phys. Rev. Lett. **94**, 035001 (2005).

J. R. Danielson and C. M. Surko, Radial compression and torque-balanced steady states of single-component plasmas in Penning-Malmberg traps, Phys. Plasmas **13**, 055706 (2006).

Plasma Stability and Reproducibility

- Experimentally, it is not easy to attain and stay in the strong drive regime (SDR) and simultaneously apply evaporative cooling (EVC).
- We only learned how to do this this past summer, and the stability of our plasmas has greatly increased.
 - A short term stability scan is shown at right.
 - The long term stability is shown below.
 - The remaining long term drift is likely due to drifts in our magnetic fields.

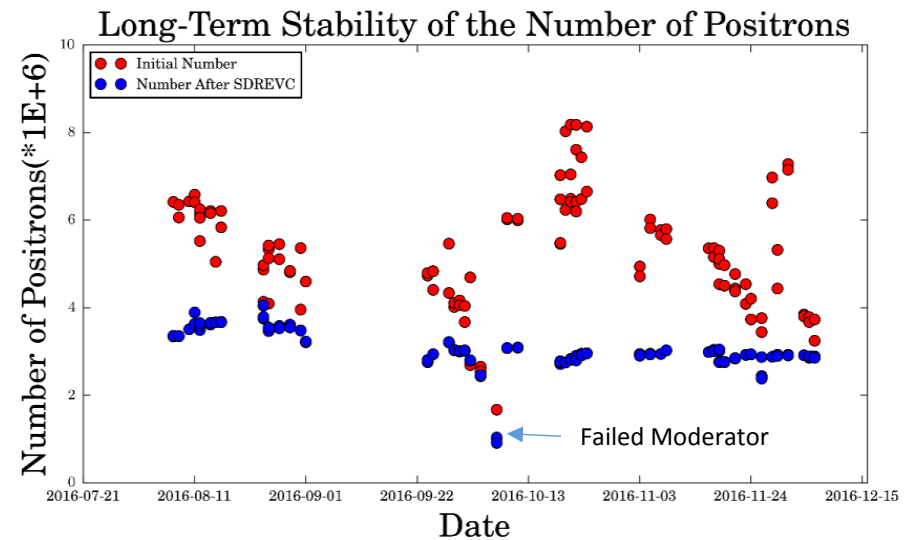
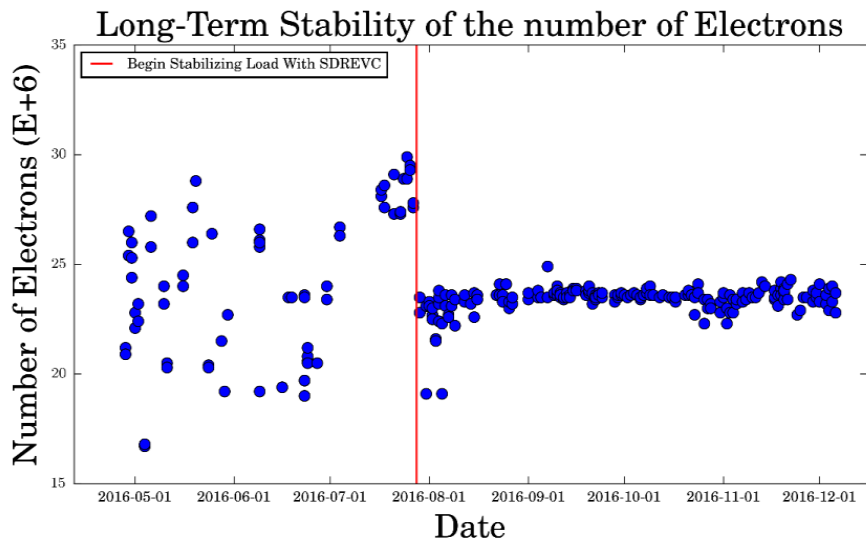
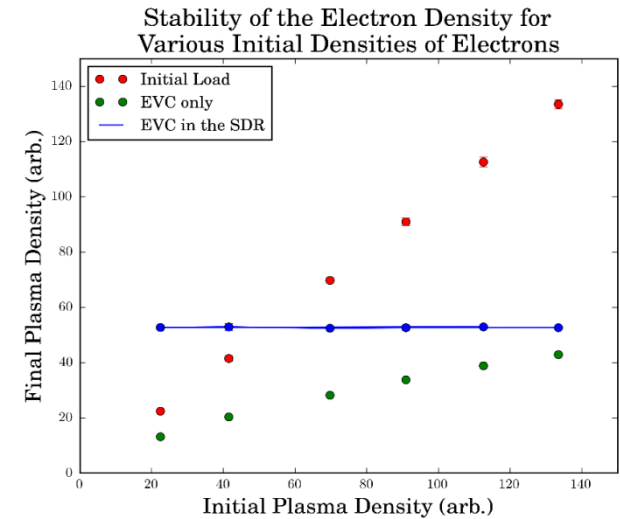

- With SDR EVC stabilization, our trapping rate increased ten-fold.**

Mixing

- To overcome the plasma space charge issues, the positron and antiproton plasmas have to be mixed together delicately.
 - Until late this year, we used autoresonant mixing.
 - Autoresonance is a very general phenomenon in driven nonlinear oscillators.
 - Here, we used it to gently control the average energy of a the antiprotons by sweeping a drive frequency.
 - The antiproton plasma behaves like a coherent phase space object.
 - Autoresonance is robust against variations in the plasma parameters.
 - With our increased stability from SDREVC, we could investigate less robust mixing techniques.

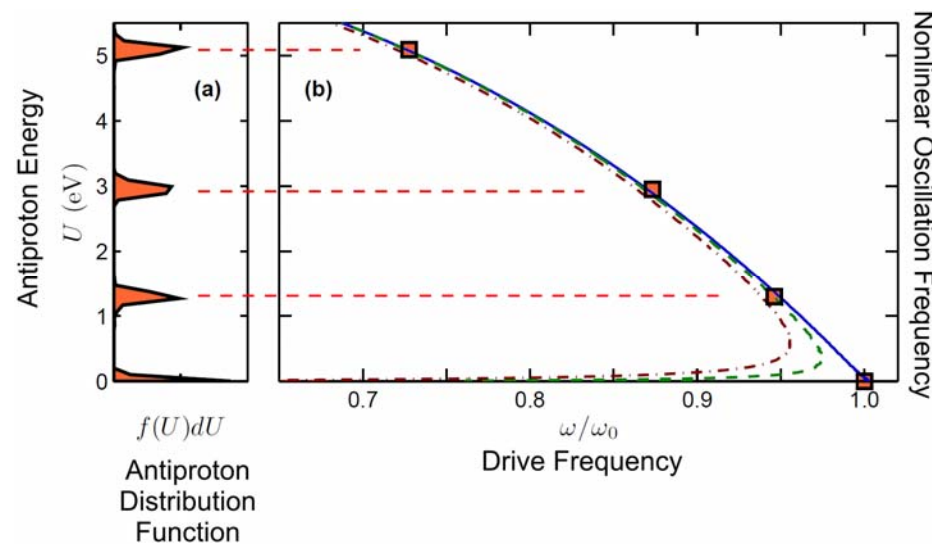

J. Fajans, E. Gilson and L. Friedland, *Autoresonant (nonstationary) excitation of the diocotron mode in non-neutral plasmas*, *Phys. Rev. Lett.* **82**:4444, 1999.

J. Fajans and L. Friedland, *Autoresonant (non stationary) excitation of a pendulum, Plutinos, plasmas and other nonlinear oscillators*, *Am. J. Phys.*, 69:1096, 2001.

W. Bertsche, ALPHA, *Autoresonant excitation of antiproton plasmas*, *Phys. Rev. Lett.*, **106** 025002 (2011).

I. Barth, L. Friedland, E. Sarid, and A. G. Shagalov, *Autoresonant Transition in the Presence of Noise and Self-Fields*, *Phys. Rev. Lett.*, **103**, 155001 (2009).

Mixing

- We have switched over to mixing by tipping.
 - Requires very stable plasmas.
 - Yields a higher trapping rate than autoresonance.
 - We don't yet understand the detailed plasma physics of this operation.

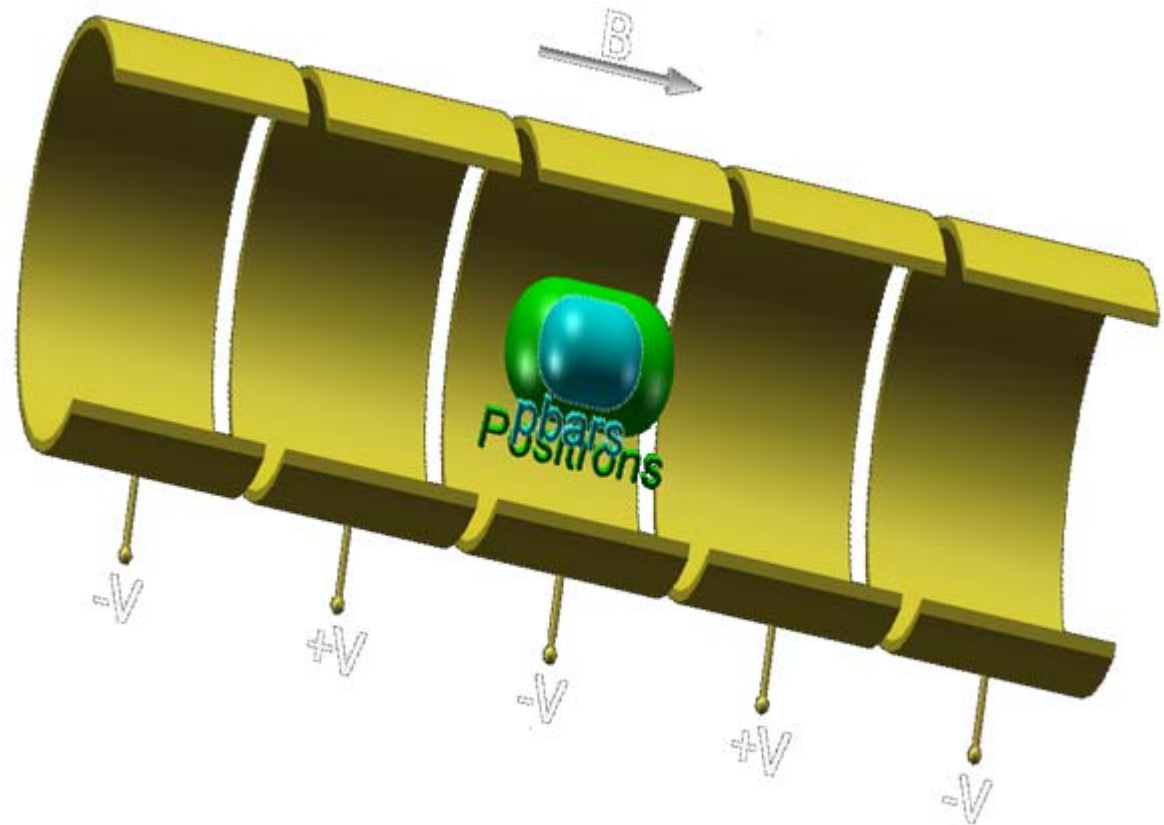

Antihydrogen Charge

- Normal matter atoms are known to be charge neutral to remarkable precision: on the order of $10^{-21}e$.
- CPT and quantum anomaly cancellation demand that antihydrogen be charge neutral to a similar level.
- How well is the charge of antihydrogen known?
 - Only prior limits on antihydrogen are at the $10^{-2}e$ level.
 - Techniques used for normal matter atoms are inapplicable.
 - Using superposition:
 - Charge of the antiproton is known to $7 \times 10^{-10}e$.
 - Charge of the positron is known to $2.5 \times 10^{-8}e$.
 - This positron bound is substantially weaker than the antiproton bound.
 - Thus, prior experimental limit is about $2.5 \times 10^{-8}e$.
 - *Does superposition apply?*
- Thus, a search for the charge of antihydrogen is a novel and potentially interesting test of fundamental physics.

Bressi, G. et al. Testing the neutrality of matter by acoustic means in a spherical resonator. *Phys. Rev. A* **83**, 052101 (2011).

Greenland, P. T. *Antimatter*, Contemporary Physics **38**, 181 (1997).

Olive, K. A. et al. Review of particle physics. *Chinese Phys. C* **38**, 090001 (2014).

Fee, M. S. et al. Measurement of the positronium $1^3S_1-2^3S_1$ interval by continuous-wave two-photon excitation. *Phys. Rev. A* **48**, 192 (1993).

Hori, M. et al. Two-photon laser spectroscopy of antiprotonic helium and the antiproton-to-electron mass ratio. *Nature* **475**, 484 (2011).

Hughes, R. J. & Deutch, B. I. Electric charges of positrons and antiprotons. *Phys. Rev. Lett.* **69**, 578 (1992).

Antihydrogen Charge

- By searching for the deflection of antihydrogen atoms by an electric field, we found (2014) that the antihydrogen charge is $(-1.3 \pm 1.1 \pm 0.4) \times 10^{-8} e$ (one sigma).
 - The errors are from statistics and systematic effects.
 - Compatible with zero.
- This bound is marginally better than the bound inferred by superposition.

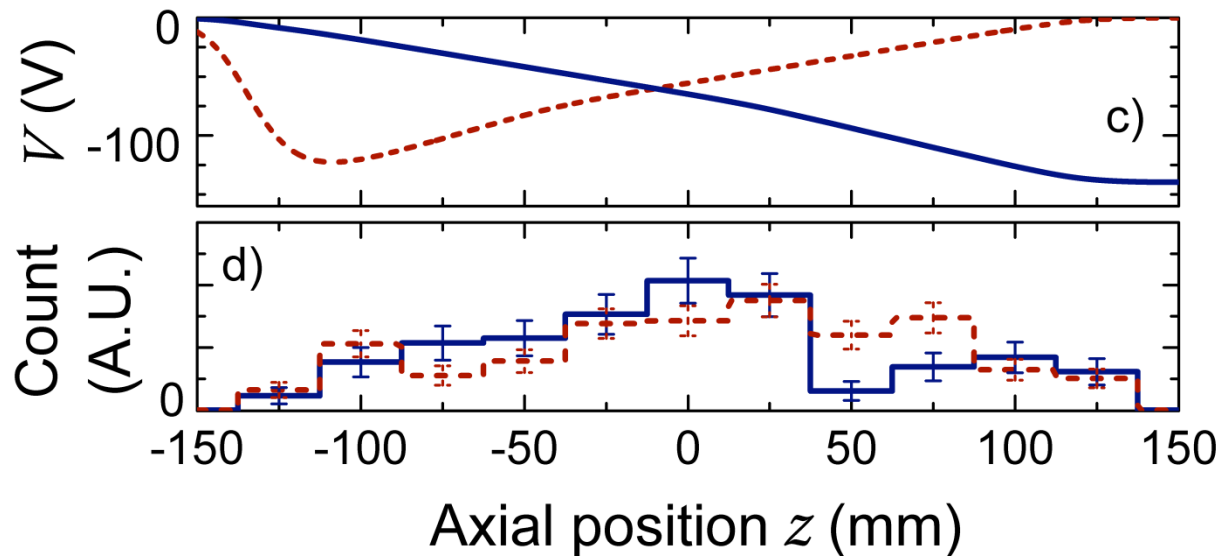

- Sample size was 241 antiatoms.
 - This was almost all the antiatoms we trapped in 2010 and 2011.
- With our improved plasma techniques, we trapped over 7000 antiatoms in 2016.

Antihydrogen Charge Bound Using Stochastic Acceleration

- Stochastic acceleration (Fermi acceleration) can eject putatively charged antiatoms from the trap.
 - Stochastic acceleration: the acceleration of a charged particle by randomly time-varying electric fields.
 - This is a “textbook” problem in nonlinear dynamics/plasma physics.

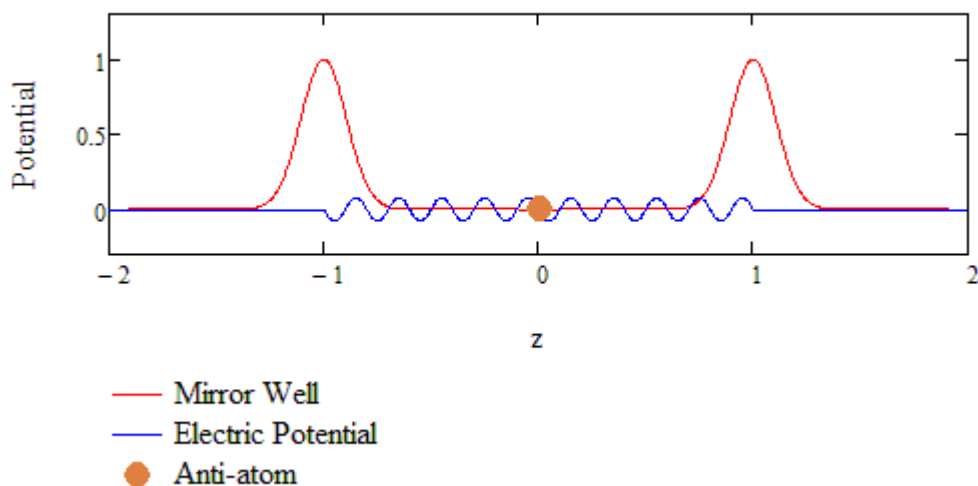

- This is a much more accurate technique than trying to deflect an antiatom with static fields.
- Using this technique in 2016, we were able to bound the change of antihydrogen to less than 0.7ppb.
 - Since the charge of the antiproton is also known at this level, we were able to establish a new bound on the positron charge at the 1ppb level, an improvement in this measurement by a factor of 25.

M. Baquero-Ruiz, A. E. Charman, J. Fajans, A. Little, A. Povilus, F. Robicheaux, J.S. Wurtele and A. I. Zhmoginov, [Measuring the electric charge of antihydrogen by stochastic acceleration](#), *New J. Phys.* **16** 083013, (2014).

ALPHA, [An improved limit on the charge of antihydrogen from stochastic acceleration](#), *Nature*, **529**, 373 (2016).

M. Baquero-Ruiz, [Studies on the neutrality of antihydrogen](#). Ph.D. thesis, University of California, Berkeley, 2013.

Conclusions

- Plasma physics funded by the NSF/DOE Plasma Partnership has been the key to the success of the ALPHA collaboration's effort to trap and study the properties of antihydrogen atoms.
- Physics measurements performed by ALPHA are already improving our knowledge of fundamental parameters, and will likely shortly be the best test of CPT.

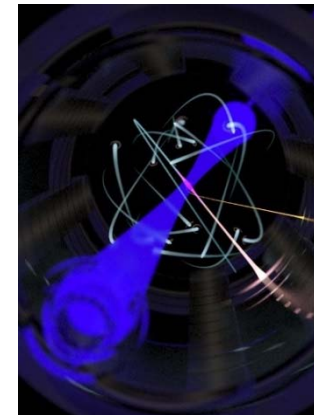
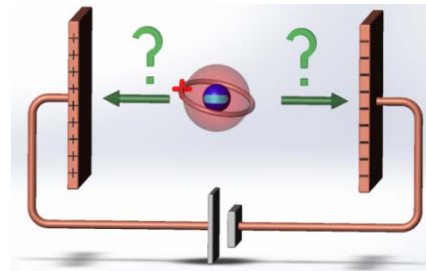
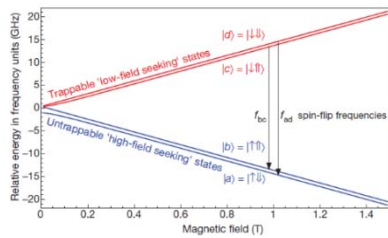

NSF/DOE Supported Researchers

who have contributed to antihydrogen research

Auburn	University of California, Berkeley	University of California, Berkeley	University of California, San Diego	University of North Texas
Undergraduate Students	Undergraduate Students	Post-docs	Undergraduate Students	Undergraduate Students
Christine L. Taylor	Andrew Christensen	Andrey Zhmoginov	Kevin Rigg	Alex Treacher
Jennifer Hurt	Carlos Sierra	Visitors	Robert Lynch	Cristina Castillo
Jingjing Zhang	Caroline Wurden	A. Deutsch	Salee Klein	Cynthia Correa
Kelsie Niffenegger	Cheyenne Nelson	Daniel de Miranda Silveira	Graduate Students	Erin Thornton
Patrick H. Donnan	Crystal Bray	Dirk van der Werf	Anne Cass	Javier Rocha
Patrick T. Carpenter	Fumika Isona	Don Prosnitz	David A. Schechter	Joshua Wofford
Graduate Students	Helia Kamal	Jeff Hangst	Eric Bass	Marisol Hermosillo
Turker Topcu	Johnny Martinez	Katya Gomberoff	Eric Hollmon	Ryan Lane
Purdue	Keiran Murphy	Lazar Friedland	Jason M. Kriesel	Graduate Students
Faculty	Matt Turner	Niels Madsen	Jonathan Yu	Aimee Ayton
James D. Hanson	Mike Zhong	Perter Haugen	Noah C. Hurst	Allen Kiestler
Francis Robicheaux	Nate Belmore	Pierre Michel	Robert B Lynch	Franz Aguirre
	Nicole Lewis	Xaiolan Liu	Stanislav Kuzmin	Franz Aguirre
	Robert Shalloo	Researchers	Steven Gilbert	Jose Correa
	Ryan McPeters	Arielle Little	Terry Hilsabeck	Jose Pacheco
	Sabrina Shanman	Tim Tharp	Toby Weber	Ryan Hedlof
	Stefania Balasiu	Instructors	Post-docs	Ryan Phillips
	Graduate Students	Andrew Charman	James P. Sullivan	Faculty
	Alexander Povilus	Matthias Reinsch	Kevin Fine	Carlos Ordonez
	Celeste Carruth	Faculty	Pei Huang	
	Chukman So	Joel Fajans	Pit Schmidt	
	David Gee	Jonathan Wurtele	Researchers	
	Eric Hunter		Andre Kabantsev	
	Jim Keller		Francois Anderegg	
	Lenny Evans		James Danielson	
	Marcelo Baquero-Ruiz		Rodrick G. Greaves	
	Steve Chapman		Faculty	
	William Bertsche		C. Fred Driscoll	
			Cliff Surko	
			Dan Dubin	
			Tom O'Neil	

In addition, groups at Aarhus, Calgary, Caltech, Columbia, Beloit, Brigham Young, First Point Scientific, Harvard, Hiroshima, Lawrence, Marquette, Manchester, NIST, Princeton, RIKEN, Rio de Janeiro, Simon Fraser, Swansea, Tokyo, and elsewhere have made significant contributions to the underlying nonneutral plasma physics.