

FUSION ENERGY SCIENCES ADVISORY COMMITTEE REPORT

Transformative Enabling Capabilities for Efficient Advance Toward Fusion Energy

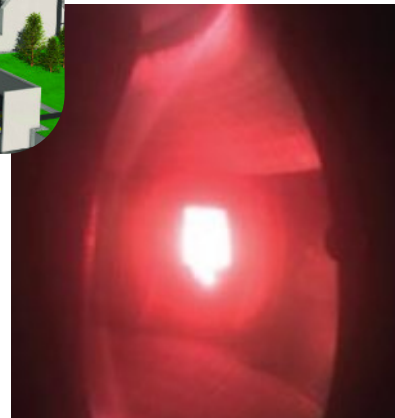

Feb. 2018

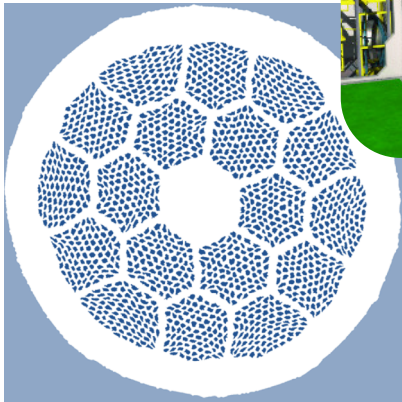
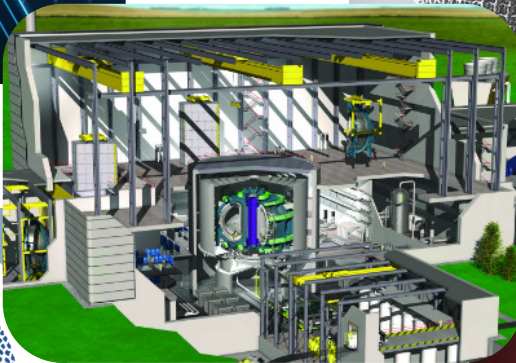

U.S. DEPARTMENT OF
ENERGY

Office of
Science

Fusion Energy Sciences

Preceding page image credits

Top images:

Upper Left: schematic representation of Neural Network (Laurent T / Shutterstock)

Upper Right: example of Advanced Manufacturing

http://nfpahub.com/news/wp-content/uploads/2015/02/ORNL_additive_mfg.jpg

Center image:

Conception of fusion power plant (© EUROfusion): <https://www.iter.org/sci/Fusion>

Bottom images:

Lower Left: high critical temperature superconducting strand cross-section (Jianyi Jiang, Applied Superconductivity Center, National High Magnetic Field Laboratory)

Lower Right: liquid lithium limiter in EAST

<https://www.sciencedaily.com/releases/2016/04/160406124637.htm>

**FESAC SUBCOMMITTEE ON TRANSFORMATIVE ENABLING CAPABILITIES
TOWARD FUSION ENERGY**

Chair: Rajesh Maingi, Princeton Plasma Physics Laboratory
Co-Chair: Arnie Lumsdaine, Oak Ridge National Laboratory
FES Contact: Sam Barish, U.S. Department of Energy

Sub-panels: *Plasma Diagnostics, Actuators, and Control (Physics and computation)*
Anne White, Massachusetts Institutes of Technology – sub-panel lead
Luis Chacon, Los Alamos National Laboratory
Steve Gourlay, Lawrence Berkeley National Laboratory
David Humphreys, General Atomics
Val Izzo, University of California, San Diego

Plasma Materials Interaction (Material science and engineering)
Jean-Paul Allain, University of Illinois – sub-panel lead
Juergen Rapp, Oak Ridge National Laboratory
Oliver Schmitz, University of Wisconsin, Madison
Chris Spadaccini, Lawrence Livermore National Laboratory
Zhehui (Jeff) Wang, Los Alamos National Laboratory
Brian Wirth, University of Tennessee, Knoxville

Reactor and Balance of Plant (Mechanical, electrical, and nuclear engineering)
Charles Greenfield, General Atomics – sub-panel lead
Jerry Hughes, Massachusetts Institutes of Technology
Harry McLean, Lawrence Livermore National Laboratory
Jon Menard, Princeton Plasma Physics Laboratory
Brad Merrill, Idaho National Laboratory

Technical Editor: John Greenwald, Princeton Plasma Physics Laboratory

Fusion Energy Sciences
Office of Science
U.S Department of Energy
Final Report – February 2018



Table of Contents

I. Executive Summary	v
II. Introduction	1
III. Grand Challenges and Knowledge Gaps	6
1. Diagnostics, Actuators, and Control	
2. Plasma-Material Interactions	
3. Reactor and Balance-of-Plant	
IV. First Tier Transformative Enabling Capabilities	14
1. Advanced Algorithms	
2. High Critical Temperature Superconductors	
3. Advanced Materials and Manufacturing	
4. Novel Technologies for Tritium Fuel Cycle Control	
V. Second Tier Transformative Enabling Capabilities	60
1. Fast Flowing Liquid Metal Plasma Facing Components	
VI. Foundational and Enabling Activities	65
1. Novel Measurements	
2. Current Drive Capability for Fusion Devices	
3. Actuators for Disruption Control and Mitigation	
4. Exascale Computing	
5. Advanced Divertor Concepts for Fusion Devices	
6. Tritium and Lithium Safety	
7. Advanced Power Extraction Techniques	
8. Foundational Program Areas and Test Beds	
VII. Appendices	82
A. Charge Letter	
B. List of Subcommittee Members	
C. Definition of Technology Readiness Level	
D. Description of process and panel call for community input	
E. List of white papers and agendas	
F. Agenda: Community Input Workshop 1	
Agenda: Community Input Workshop 2	
Agenda: Community Input Workshop 3	
G. List of Acronyms	

I. Executive Summary

1. Executive Summary

Introduction

Fusion reactions are the primary source of energy in the known universe, powering the stars and our sun. Because the source of fusion fuel on earth is virtually unlimited, consisting of deuterium from water and lithium from rocks and is used to generate tritium, the realization of commercially viable fusion power would solve the problem of securing a clean, global energy supply. However, controlled fusion energy on earth is a scientific and engineering grand challenge, and challenges remain on the path to develop and deploy fusion power stations. This report seeks to identify technologies or capabilities that could shorten this development time, and bring an affordable fusion power station to market more quickly.

The Fusion Energy Sciences Advisory Committee (FESAC) was charged “to identify the most promising transformative enabling capabilities (TEC) for the U.S. to pursue that could promote efficient advance toward fusion energy, building on burning plasma science and technology.” The charge letter lists representative focus areas including, but not limited to, “liquid metals, additive manufacturing, high critical-temperature superconductors, exascale computing, materials by design, machine learning and artificial intelligence, and novel measurements.” The process of discussing and evaluating the current state of the art to identify capabilities that can accelerate the path to affordable fusion power is valuable, and could be an important step in the innovation process. Presenting these promising transformative capabilities will help us to identify priorities, and will stimulate dialog inside and outside the fusion community, promoting cross-cutting innovation.

The advisory committee formed a subcommittee of U.S. technical experts that received community input via white papers and presentations on the charge questions. The subcommittee also leveraged previous community reports to identify gaps and research needs, and to shape pathways for the future of fusion energy research^{1,2}. Within the subcommittee’s deliberations, the following working definition was adopted:

- A TEC is a *revolutionary* idea, that is beyond *evolutionary*; it is a “*game-changer*.” A TEC would dramatically increase the rate of progress towards a fusion power plant. Examples of payoffs include a substantial increase in fusion performance, enabling device simplification, reduction in fusion system cost or time to delivery, or improvement in reliability and/or safety.
- Two tiers of TECs were identified:
 - In the first group, the capability is advancing rapidly as driven by other fields, and/or the reward/risk ratio is clearly favorable; these are highlighted as very promising TECs.
 - In the second group, the transformative potential is clear, but risks are more substantial, and/or the rewards are more difficult to quantify; these are highlighted as promising TECs.

¹ “Priorities, Gaps and Opportunities: Towards A Long-Range Strategic Plan for Magnetic Fusion Energy”, FESAC Greenwald Panel Report, October 2007

² “Research Needs for Magnetic Fusion Energy Science”, Report of the Research Needs Workshop (ReNeW), June 9-13, 2009

- Some TECs would benefit from innovations in other TECs to fulfill their promise.

In addition to these TECs (described below), a number of activities were identified as foundational but not transformative on the path toward a fusion reactor. These capabilities are nonetheless necessary and the development of a fusion power plant probably cannot happen without them. These necessary elements are largely part of the existing fusion science R&D program and are highlighted in Chapter 6. Also included in this chapter is a discussion of necessary testing facilities. The operation of current facilities, and the development of new facilities, will be essential in order to continue developing and assessing the capabilities included in this report.

First Tier Transformative Enabling Capabilities

The four top tier TECs identified by the panel are: advanced algorithms, high critical temperature superconductors, advanced materials, and novel technologies for tritium fuel cycle control. Each of these is described in Chapter 4 in the main body of the report. Note that the panel did not prioritize amongst these four sets of capabilities.

Advanced Algorithms – Advanced algorithms will transform our vision of feedback control for a power-producing fusion reactor. The vision will change from one of basic feasibility to the creation of intelligent systems, and perhaps even enabling operation at optimized operating points whose achievement and sustainment are impossible without high-performance feedback control. The area of advanced algorithms includes the related fields of mathematical control, machine learning, artificial intelligence, integrated data analysis, and other algorithm-based R&D. Given the pace of advances, control solutions that establish fusion reactor operation will become within reach, as will the discovery and refinement of physics principles embedded within the data from present experiments. This TEC offers tools and methods to support and accelerate the pace of physics understanding, leveraging both experimental and theoretical efforts. These tools are synergistic with advances in exascale and other high-performance computing capabilities that will enable improved physics understanding. Machine learning and mathematical control can also help to bridge gaps in knowledge when these exist, for example to enable effective control of fusion plasmas with imperfect understanding of the plasma state.

High Critical Temperature Superconductors – Advances in higher temperature and/or higher field superconductors present a game-changing opportunity to enhance the performance and feasibility of fusion reactor designs. Superconducting magnet systems are the essential enabling technology for magnetic confinement fusion devices, and fusion reactors designed with high magnetic fields have practical advantages. The transformative aspect of high-temperature superconductors comes from their ability to produce magnetic fields well beyond currently available technology, and to potentially reduce the time and cost of fusion science research for power generation. Achievement of higher magnetic fields would result in more compact burning plasma experiments, with high-energy gain and high power density that would be more economically attractive for commercialization. Operation at temperatures higher than today's conventional low-temperature superconductors also raises the prospect of using demountable magnetic field joints, greatly improving access for construction and maintenance.

Advanced Materials and Manufacturing – New material designs and advanced fabrication will enable the realization of resilient components that are essential to survive the harsh fusion environment and to optimize the reactor’s performance. The novel features enabled by advanced manufacturing and additive manufacturing (defined in 4.3) include complex geometries and transitional structures, often with materials or constituents including hard-to-machine refractory metals; the potential for local control of material microstructure; rapid design-build-test iteration cycles and exploration of materials and structures for containing and delivering slow-flow liquid metals. With these emerging techniques, resilient materials and components for a fusion reactor can be realized. Moreover these innovative materials should enable the realization of compact cost-effective fusion device designs that tend to concentrate plasma bombardment into small deposition areas.

Novel Technologies for Tritium Fuel Cycle Control – Because D-T fusion power plants must produce their own tritium fuel, innovative concepts for fuel production, fuel extraction, and fuel reprocessing show clear transformative potential. In fuel production, several blanket technologies will enable significantly higher thermal-to-electrical efficiency in generating tritium within the blanket. Both increases will significantly reduce fusion plant operating costs. In fuel extraction, several new tritium extraction technologies proposed for liquid metal breeding blankets and plasma facing components promise very high extraction efficiencies that will maximize plant performance and safety. Finally, in fuel processing, a key technology has the potential to simultaneously decouple plasma and tritium plant operation and reduce the size and inventory of the tritium plant by ~75%.

Second Tier Transformative Enabling Capabilities

Here we describe the single second tier TEC identified by the panel (described in Chapter 5): fast flowing liquid metals to serve as plasma facing components. In this context, fast flow means on the order of m/s. Slow-flow liquid metals captured within substrates with speeds ~ cm/s are described in the Advanced Materials TEC.

Fast flowing Liquid Metals – Fast flowing liquid metal plasma facing components may prove to be an attractive alternative to handle both high steady-state and transient plasma heat flux in a fusion reactor power plant, which would revolutionize control of the plasma-material interface. Liquid metals continually replenish material and are self-healing, eliminating concerns for the lifetime of solid materials, which erode with constant plasma bombardment. In addition, certain liquids, e.g. lithium, can strongly improve plasma confinement and lead to smaller, more economical reactor designs. There are however, several important knowledge gaps in these systems, including managing the tritium fuel retention, maintaining clean surfaces for reliable flow, counteracting mass ejection forces, determining operating temperature windows, and demonstrating helium ash exhaust. Given these gaps and the modest industrial investment in fast flow liquid metals for other tasks, this line of research was evaluated as a Second Tier TEC, i.e. “potentially transformative.”

Each of these TECs presents a tremendous opportunity to accelerate fusion science and technology toward power production. Dedicated investment in these TEC areas for fusion systems is needed to capitalize on the rapid advances being made for a variety of non-fusion applications, to fully realize their transformative potential for fusion energy.

II. INTRODUCTION AND BACKGROUND

2. Introduction and Background

Motivation

The flourishing of humanity is tied directly to the availability of copious amounts of energy that is essential to many aspects of development, such as clean water, health facilities, sanitation, food production, and industrialization. Yet roughly a billion people on planet Earth have no access to electricity, and countless others have only intermittent and unreliable access. Furthermore, the two most populous nations on Earth continue the process of industrialization, and require increased electrical production to bring their standard of living in line with developed countries. Nuclear fusion is the primary source of energy in the universe, powering the stars including our sun. The realization of commercially viable fusion power would essentially solve the problem of energy supply. The source of fuel is virtually unlimited, the reaction inherently safe, and the process is environmentally benign. Thus, the National Academy of Engineering identified “providing energy from fusion” as one of the 14 Grand Challenges for Engineering in the 21st century. While progress in scientific understanding and technological development has been steady, it is still the case that a fusion power plant may be a generation away, according to most international roadmaps. This raises the question: Are there technologies or capabilities that might allow us to shorten this development time, and bring affordable fusion power plants to fruition more quickly? Consideration of this question is the purpose of this report.

The Fusion Energy Sciences Advisory Committee (FESAC) was charged “to identify the most promising transformative enabling capabilities (TEC) for the U.S. to pursue that could promote efficient advance toward fusion energy, building on burning plasma science and technology.” The charge letter (shown in Appendix A) states representative focus areas including, but not limited to, “liquid metals, additive manufacturing, high critical-temperature superconductors, exascale computing, materials by design, machine learning and artificial intelligence, and novel measurements.” The charge further asked FESAC to “comment on the promise, level of maturity, development requirements, risks and uncertainties, and time horizon for each. Please consider global strengths and gaps in identifying areas of particular opportunity for the U.S.”

Description of Process

In response to the charge, a subcommittee of technical experts was formed. This subcommittee divided into three subpanels, each of which focused on a different topical area of reactor development:

1. Plasma diagnostics, actuators, and control (physics and computation)
2. Plasma materials interaction (material science and engineering)
3. Reactor and balance of plant (mechanical, electrical, and nuclear engineering)

The subcommittee solicited white papers from the community and conducted three workshops where presentations were given (see Appendices E and F). White papers were guided (Appendix D) to address seven points in order to assist the subcommittee in evaluating the topics presented according to the charge. These seven points were:

1. Technology to be assessed
2. Application of the technology
3. Critical variable(s) – variable that determines or controls the output of the technology
4. Design variables – “input” variables that can be controlled to optimize the output

5. Risks and uncertainties
6. Maturity
7. Technology development for fusion applications

Presentations were given at the three workshops by those who submitted white papers, and presentations were also solicited in certain areas of transformative potential (such as machine learning and additive manufacturing), where subject matter experts were outside of the fusion community. Participation was also sought by experts in industry, and by related communities (such as nuclear fission). Each of the three subpanels evaluated the different presentations in their topical area. A general metric was used for evaluation of the various technologies, considering the transformative impact, the risks and uncertainties, the maturity and development, and the broader impact of the technology. Each subpanel developed a list of most promising TECs in their area, and the entire subcommittee met, debated, and formed consensus around the TECs that are presented in this report.

Definitions

Transformative Enabling Capability

In order to be responsive to the charge, the subcommittee had to agree on what is meant by a “Transformative Enabling Capability” (TEC). The following definition was used:

- A TEC is a *revolutionary* idea, beyond *evolutionary*; it is a “*game-changer*,” something that could lead to one or more of the following: a substantial increase in fusion performance, enabling device simplification, reduction in fusion system cost or time to delivery, or improvement in reliability and/or safety. The rate of progress towards a fusion power plant in one of these areas should substantially increase.
- In some cases, innovations are needed in several areas to capitalize on certain TECs, e.g. a higher power density system needs to be paired with innovation in plasma exhaust.
- Two tiers of TECs were identified:
 - In the first grouping, the capability is advancing rapidly as driven by other fields, and/or the reward/risk ratio is clearly favorable; these are highlighted as very promising TECs.
 - In the second grouping, the transformative potential is clear, but risks are more substantial, and/or the rewards are more difficult to quantify; these are highlighted as promising TECs.

Level of Maturity

The charge requested comment on the “level of maturity” of the TECs. The subcommittee decided to adopt the Technology Readiness Level (TRL) as the measure of maturity. The concept of the TRL was developed by NASA in the 1970’s and 1980’s¹, and has been adopted by a variety of other agencies, including the Department of Defense² and the Department of Energy³. The purpose of TRLs is to “provide a systematic and objective measure of the maturity of a particular technology.”⁴ The TRL scale goes from TRL 1 (basic research) through TRL 9 (system in operation). The different levels can be briefly summarized as:

- TRL 1 – pure research
- TRL 2 – applied research
- TRL 3 – laboratory testing of individual components
- TRL 4 – laboratory testing of integrated components
- TRL 5 – field testing of integrated components (lab scale)

- TRL 6 – field testing of scale prototype
- TRL 7 – full-scale testing of prototype in cold conditions
- TRL 8 – system completed and qualified through test and demonstration
- TRL 9 – actual system operations in full range of conditions

Further description is given in Appendix C. For the sake of this report, each capability is assessed in term of its application towards a fusion power plant. That is, a TRL 9 would indicate that the capability has been commissioned and is operating in full fusion power plant conditions. At the current state of fusion development, this means that almost all capabilities will have a ceiling of TRL 6. In some cases, a TRL of 7 may be possible once ITER is operating. This is the definition that is taken by Tillack, et al.⁵

Overview of Conclusions

The four top-tier TECs identified by the panel are: advanced algorithms, high-temperature superconductors, advanced materials, and tritium fuel control. Each of these is described in a separate section of Chapter 4. Note that the panel did not prioritize amongst these four sets of capabilities. A single second-tier TEC identified by the panel: fast flowing liquid metals to serve as plasma facing components. This is described in Chapter 5. In this context fast flow means on the order of m/s; slow flow liquid metals captured within substrates with speeds ~ cm/s are described in the Advanced Materials chapter.

In addition to these transformative capabilities, a number of activities are clearly enabling development of a fusion reactor, but their transformative potential is at best modest. That is, these capabilities are necessary, and the development of a fusion power plant probably cannot happen if we do not continue to develop them. These necessary elements are largely part of the existing fusion science R&D program and are highlighted in Chapter 6. Also included in Chapter 6 is a discussion of necessary testing facilities. The operation of current facilities, and the development of new facilities, will be essential in order to advance and assess the capabilities included in this report.

Perspectives on Innovation

One note of perspective – when the day comes that fusion power is commercially available and affordable, the innovations that led to it will be clear only in hindsight. As it stands today, the reality of electricity through fusion seems a generation away, there is no “crystal ball” to identify what innovations may bridge the gap, and any attempt to do so must be done with a measure of humility. The process of innovation is unpredictable; most of the game-changing innovations of the last 50 years were not developed through a planned, deductive process, but through a combination of good ideas, hard work, smart people, and serendipity. Given that we cannot predict the future, and the assessments in this report would likely receive a mixed reaction if read 40 years from now, with some recommendations probably viewed favorably in retrospect, and some less so, is there value in the effort of making such assessments? Clearly, there is. The process of discussing and evaluating the current state of the art to identify capabilities that can accelerate the path to affordable fusion power is valuable, and very well could be an important step in the innovation process. Presenting these promising, possibly transformative, capabilities can be an aid to not only setting priorities, but to initiating dialog inside and outside the fusion community (including industrial involvement), which is often a key step of innovation.

The charge to FESAC indicated “examination of developments that can bring the tokamak and stellarator concepts closer to production fusion power practically . . . an assessment of various types of magnetic confinement devices is not to be performed.” Thus, the work of the committee focused on applications towards these toroidal configurations. While it is acknowledged that there may be value in other configurations, the focus of the community, and the current state of scientific readiness, lends itself to focus on the tokamak and stellarator as the most promising path to fusion power.

As technologies rapidly advance in many adjacent fields, as our understanding of fundamental plasma and material science grows, this type of assessment needs to be conducted regularly. Dialog with those in other energy and technology sectors (private and public) should continue to be pursued, as these types of interactions commonly lead to new thinking that sow the seeds of innovation. It is to be hoped that this report is not an end, but only a beginning of a process that will culminate in the production of an entirely new, clean, safe, and affordable energy source.

References

1. J. Banke, 2010 “*Technology Readiness Levels Demystified*,” https://www.nasa.gov/topics/aeronautics/features/trl_demystified.html
2. 2011 *United States, Department of Defense, “Technology Readiness Assessment (TRA) Guidance*,” <http://www.acq.osd.mil/chieftechologist/publications/docs/TRA2011.pdf>
3. 2015 *DOE G 413.3-4A, “Technology Readiness Assessment Guide*,” <https://www.directives.doe.gov/directives-documents/400-series/0413.3-EGuide-04-admchg1/@@images/file>
4. 2016 *GAO-16-410G, “Technology Readiness Assessment Guide: Best Practices for Evaluating the Readiness of Technology for Use in Acquisition Programs and Projects*,” <http://www.gao.gov/assets/680/679006.pdf>
5. M. S. Tillack *et al.*, 2009 *Fusion Sci.. Techn.* **50** 949

III. GRAND CHALLENGES IN FUSION SCIENCE AND TECHNOLOGY

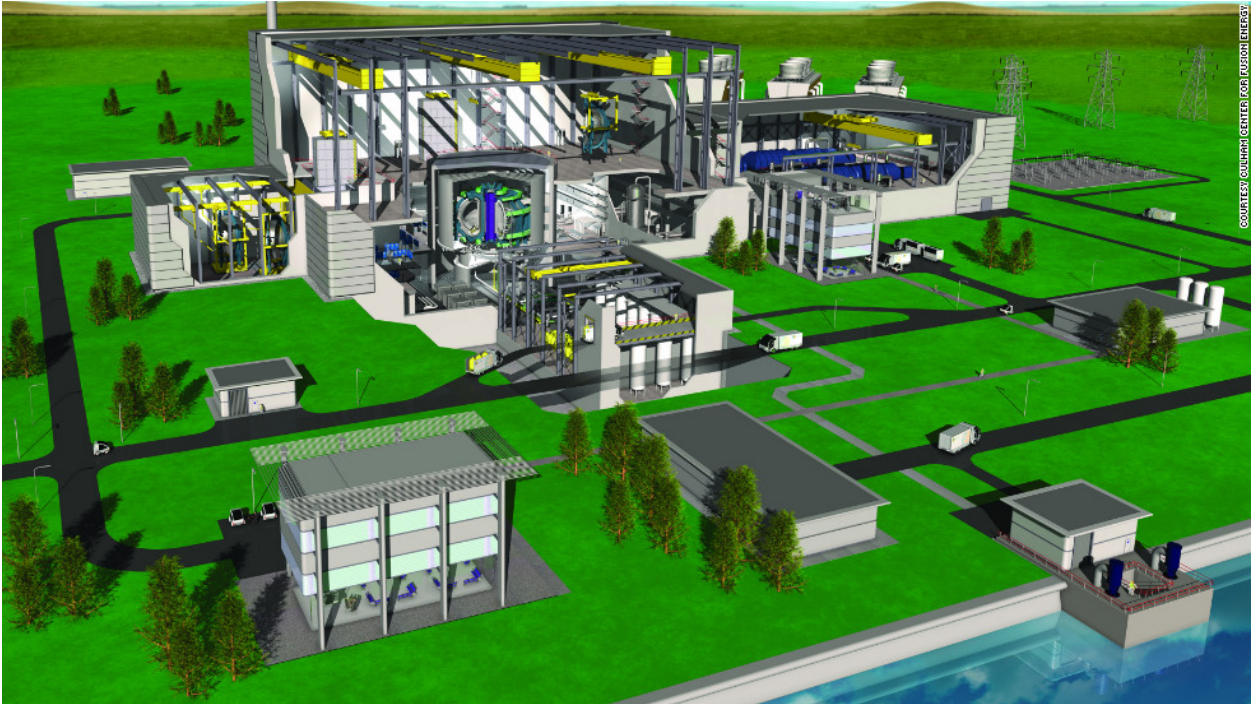

Conception of fusion power plant (© EUROfusion): <https://www.iter.org/sci/Fusion>

3. Grand Challenges in Fusion Science and Technology

Introduction

Context for consideration of the charge question to identify transformative capabilities can be obtained by identifying the leading questions in fusion science and technology, so-called grand challenges. The identified transformative capabilities would then naturally address these grand challenges. To this end, the panel subdivided into three groups to identify grand challenges within three areas: diagnostics, actuators and control; plasma-material interactions; and reactor and balance-of-plant issues.

In this chapter, the grand challenges identified by the panel are discussed in three sections, corresponding to the three groupings above. The subcommittee relied heavily on recent FESAC and community reports to identify these grand challenges, which have been formulated as questions. The transformative enabling capabilities that were identified, however, typically transcended two or all three subgroups; hence they are properly viewed as outputs of the entire panel.

3.1 Diagnostics, Actuators and Control

The area of diagnostics, actuators and control represents what is usually considered to be the rich field of plasma physics. As scientific theories and measurement capabilities have advanced, increasing emphasis is being placed on feedback control of plasmas, using both advanced diagnostics as inputs, and appropriate actuators to perform the control. This section describes the grand challenges in ensuring stable reactor operation, management of plasma exhaust from the plasma side, economic attractiveness, and imperfect model predictability for feedback control.

- **How can we ensure sufficiently robust stability (passive or active) and near-zero disruptivity for a reactor plasma?**

A transient event in an otherwise stable fusion reactor will release plasma energy in a short period of time. Negative effects of such events may range from damage to plasma facing components and other structures to cessation of the plasma discharge entirely.

Mitigating the negative effects of transient events in a reactor, or avoiding the occurrence of disruptive transient events altogether has long been identified as a key challenge for the development of fusion¹. Disruptions are specifically important to avoid in tokamak-based reactors², and stellarator-based may also experience transient events common to both reactor designs (e.g. rapid influx of impurities resulting from “flake” of Plasma Facing Component (PFC) or wall material falling into the plasma).

Advances in predicting, controlling and mitigating transient events are enabled by the TEC known as “Advanced Algorithms”, including Artificial Intelligence and Machine Learning. Foundational tools used for this purpose would be novel diagnostics and analysis techniques, and high performance computing (HPC)³, among others.

The handling of heat fluxes during transient events is strongly linked to the grand challenges involving plasma material interactions.

- **How can divertor heat fluxes be managed steady-state under reactor conditions?**

Heat exhaust management in steady-state is a grand challenge for both tokamak and stellarator-based fusion reactor designs. In particular, divertor heat fluxes at levels of 5-10 MW/m² can be especially challenging to manage¹.

From a diagnostics, control and actuator perspective, new integrated approaches are required to tackle this problem⁴. The “Advanced Materials” and “Advanced Algorithms” TECs, and the foundational tools of novel measurements, analysis methods, advanced manufacturing, and high performance computing must be synergistically utilized to manage these high heat fluxes.

Advances in technology should be leveraged to accelerate the demonstration of dissipative/detached divertor solutions for power exhaust as well as particle control⁴. This grand challenge is related to tritium inventory control and the development of innovative boundary plasma solutions and material solutions for main chamber wall components.

- **How can a fusion reactor be made sufficiently economically attractive?**

It is highly desirable to reduce the costs of the research path for fusion energy development, as well as making the end-product - fusion reactors – sufficiently economically attractive. Of course, the economic attractiveness of power plants is determined by many variables. Studies of nuclear fission reactor costs have shown that factors such as utility structure, reactor size, regulatory regime, and international collaboration have the largest impact⁵. Many of the transformative enabling capabilities (TECs) and foundational tools considered by this committee can directly impact the reactor cost in any economic scenario by affecting all of these factors.

Among all the variables, the reactor size, or scale, is certainly one major factor for both the development path and the end product. Reducing the scale of tokamak and stellarator experiments that access fusion relevant performance regimes, along with reduced scale of support systems (e.g. diagnostic suite, heating systems, current drive systems, T handling and breeding plant, cryogenic plant) reduces the costs of these experiments. Smaller, more modular components can be incorporated into standardized designs more easily, and research shows that this led to lower costs for nuclear fission power plants⁵. Experience with coal and fission power plants shows that reducing the overall size of the plant leads to a less complex construction project, which can lower costs⁵.

Several enabling technologies can directly impact system scale, such as high critical temperature superconductors (HTS) and advanced blanket technologies. By using HTS to construct coils that operate at higher magnetic fields, a case can be made for a high-field, compact facility path to fusion energy.

By using advanced blanket technologies and advanced tritium processing techniques, the overall economics of a fusion power plant can be improved. Complexity of the fusion

reactor system, also linked to cost, may be reduced by combining advanced diagnostics and advanced algorithms. Determining a minimum set of measurements and actuators for feedback and control of a reactor plasma can help reduce costs by leading to a standardized instrumentation suite.

- **How can we manage uncertainty and incomplete knowledge of key plasma physics elements needed for a fusion reactor?**

In a fusion reactor, it is safe to say that we will never have as much knowledge of the plasma behavior as we do in present-day experimental tokamaks and stellarators. This incomplete knowledge originates from diagnostic measurements and imperfect physics models. Indeed, if complete knowledge of a system's underlying physical principles needed to be fully understood, we would not have fission reactors in operation today.

The successful development and deployment of fission energy has not been held back waiting for understanding of details of every aspect of the system. As a consequence, fission reactors exist, and there is a vibrant and dynamic university research program in the U.S. surrounding all aspects of nuclear science and engineering. Managing uncertainty and incomplete knowledge of key physics elements in fission reactors is part of this research program, with a few examples being risk assessment, which utilizes advanced Bayesian statistical models to facilitate reasoning under uncertainty, and physical cryptographic warhead verification as part of nuclear security.

The fusion community could accelerate progress towards building a fusion reactor if a similar minimalist approach were taken to machine design and operation, leveraging transformative enabling capabilities such as HTS, Advanced Materials, Advanced Algorithms, and an iterative approach to Advances in tritium handling and control. Foundational tools such as advanced diagnostics and HPC³ will aid in this progress.

3.2 Plasma-Material Interactions in Fusion Reactors

Arguably, the desire to put nuclear fusion on the grid will place, in part, some of the most extreme demands on materials, and therefore is a potential driver for the development of robust damage-resistant or damage-tolerant materials. Virtually every major component of a future nuclear fusion energy reactor will require novel materials able to withstand significant limits of essential material properties including: neutron damage, creep resistance, fracture toughness, surface erosion/redeposition, corrosion, chemistry, thermal conductivity and many others. In a fusion reactor deuterium-tritium plasma is confined by strong magnetic fields at a temperature of hundreds of millions degrees celsius. The radiation interaction with matter will be dynamic imposing time-dependent changes on the structure, composition and chemistry of both bulk and surface regions of material components. Performance and lifetime limits of nuclear fusion materials will ultimately need to survive >100-dpa and >1000-appm He production over the high-duty cycle operation of the reactor. In the exhaust of such a reactor, the so-called divertor, the plasma-facing surfaces will be subjected to extremely high and intermittent heat loads (10 MW/m² time-averaged, with periodic excursions in the GW/m² level on millisecond timescales), while simultaneously being bombarded by extreme fluxes of energetic particles (hydrogen

isotopes, helium, neutrons). Currently no material is capable of meeting such requirements and in fact we are orders of magnitude away from achieving the same.

- **What are the key issues to design and develop multi-phase materials systems capable of surviving the harsh fusion reactor environment?**

Although progress has been made in the last decade in establishing an understanding of plasma-material interactions, critical knowledge gaps remain related to predicting and designing for the behavior at the plasma-material interface under reactor-relevant plasma conditions anticipated in a future plasma-burning neutron-dominated environment. The plasma-material interface is one important factor to the realization of nuclear fusion power. At this interface, high particle and heat flux from the fusion plasma can limit the material's lifetime and reliability and therefore hinder operation of the fusion device. This region is critical to operation of a nuclear fusion reactor since material can be emitted both atomistically (e.g. evaporation, sputtering, etc.) and/or macroscopically (i.e. during transient events, such as disruptions or edge localized modes). Another important factor is the limited understanding of the synergistic effects of neutron-induced modification in the bulk structural materials and surface-dominating properties (e.g. erosion, ion mixing, hydrogen and helium-induced bubbles and swelling at the surface, surface diffusion, surface chemistry, morphology and nanoscale patterning) that ultimately dictate particle recycling emitted back to the edge plasma consequently cooling the fusion plasma. Can one design a robust self-healing, adaptive multi-phase material that during exposure to the harsh conditions of a fusion reactor plasma over time it can adapt and extend its operational lifetime? Materials-by-design (MBD) is an emergent paradigm that combines a reductionist and synthetic approach envisioning a multi-scale level of control in structure and composition during manufacturing enabling tailored design of multi-functional materials could perhaps open the possibilities of radiation-tolerant and radiation-resistant materials that manipulate damage-induced defects to minimize or eliminate function degradation. MBD approaches combined with advanced and additive manufacturing may usher novel advanced materials that will disrupt our way of thinking about plasma-facing and structural fusion materials design.

- **What are the properties of material damaged/transformed under extreme conditions?**

A major challenge is the mixture of materials expected at the plasma-material interface during erosion/redeposition that can lead to intrinsic changes to composition and topography. In addition, large heat and particle flux levels in the machine will induce large shear stresses that can undermine the PFC structure and influence tungsten mechanical properties (e.g. fracture toughness, yield strength). Understanding the transformation of materials in far-from-equilibrium conditions will be critical to establish predictive algorithms in MBD approaches supported by advanced manufacturing and AM.

- **How far can we take the most emergent manufacturing approaches in designing radiation-tolerant and radiation-resistant fusion materials?**

Some current work has focused on processing techniques for bulk refractory alloys addressing a limited set of bulk materials properties. For example, some efforts focus on

attaining radiation-tolerant properties by inducing intrinsic extreme grain refinement reaching grain size distributions in the order of 50-100 nm using mechanical hardening techniques. Other approaches exploit advanced sintering techniques such as spark plasma sintering to achieve refined-grained refractory materials. However, these approaches require further development to address industrial scalability challenges, and to adaptation of these technologies for fusion-reactor relevant applications. Synthesis approaches for fusion refractory PFCs have shortcomings including: recrystallization and grain growth at high temperatures, low consolidation of sintered powders and poor machinability. In addition, the plasma-facing surface properties remain unknown in a fusion neutron and radiation environment. Additive manufacturing (AM) has shown promise in the manufacturing of complex structures with enhanced function. However, it is yet unclear how AM can be adopted and adapted to not only refractory-metal materials relevant to fusion energy reactors but more importantly (and more concerning) how thermo-mechanical properties are impacted by various AM processing. The fundamental understanding of AM-processed materials and their thermo-mechanical performance under extreme conditions is non-existent.

Although these challenges pose serious consequences to fusion energy materials development there are some promising transformational enabling breakthrough technologies that could be leveraged in the near future. These include: additive and advanced manufacturing approaches of refractory metal complex hierarchical materials, complex alloys, complex nano-to-meso scale composites, self-healing and adaptive materials, materials-by-design methodologies, hybrid liquid-solid composites and advanced cooling technologies.

3.3 Reactor and Balance of Plant

Research aimed at developing a fusion-based power plant has, to date, focused mainly on the confinement device itself, including the plasma, the first wall, and magnets and heating systems. These are all necessary features of the power plant, but not sufficient, as a number of critical issues will require progress in areas outside the present scope of Fusion Energy Science research. A particular challenge is the need to safely and efficiently fuel, exhaust, breed, confine, extract, and separate tritium in unprecedented quantities⁷. Although this is often put off for the future, the goal of economical fusion energy within the next several decades as a U.S. strategic interest⁸ implies that development of appropriate technologies cannot be put off indefinitely. Some of the capabilities needed for development and testing are straightforward and could be prepared in the short term, but a full research program would require test facilities producing environments increasingly similar to a fusion power plant (e.g. heat and radiation).

- **How can sufficient tritium be produced in a reactor blanket to provide for all of the needs of the plant without relying on off-site sources?**

Fusion reactor blanket technologies are needed that can remove heat and produce all of the tritium needed to fuel the reactor in recoverable form. The tritium breeding ratio ($TBR = \frac{\text{Tritium produced}}{\text{Tritium consumed}}$) needs to be above unity to maintain tritium self-sufficiency throughout the plant, but limited to minimize on-site inventory and/or proliferation risks. Some capability will be needed to produce excess tritium to start future reactors. Indeed,

ITER is projected to exhaust virtually the entire world supply of tritium, so that any subsequent D-T fusion devices will be required to be tritium self-sufficient.

While TBR is the most visible figure of merit for a fusion reactor blanket, there are several other requirements that must be satisfied. In particular, the blanket will have to operate under conditions of extreme thermal and nuclear loading, and fulfill the requirement to efficiently remove heat from the reactor to produce electricity.

There are numerous proposed designs for fusion blankets, all of which are currently at a low TRL. Six concepts are planned for testing in the ITER Test Blanket Module program⁹, in which all ITER partners except the U.S. are participants. Because of this, the availability of data from these tests is expected to be limited. Also, the Dual Coolant Lead Lithium (DCLL)¹⁰ concept that has long been a favorite of the U.S. community is not among those concepts being tested. A promising new approach is the Cellular Breeder concept¹¹, which takes advantage of advanced manufacturing techniques to produce a solid, dense, breeder material with an internal network of interconnected microchannels for enhanced tritium release. This is currently under active development that is expected to bring it to a TRL of 4 in 2018.

A fully integrated strategy is needed to develop and test these (and potentially other promising) concepts in time for readiness for deployment in a fusion nuclear science facility or a DEMO.

- **How can tritium produced or absorbed in liquid metals (either in the blanket or on the first wall) be extracted and made available for processing?**

Lithium-based liquid metals have been studied in the U.S. for over 40 years, both as plasma-facing components and as blanket materials. For both applications, extraction of tritium represents both a safety concern (minimizing inventory) and an opportunity (fuel cycle). Methods for this extraction have been proposed, but not demonstrated. These techniques fall into two general categories: electrolytic or permeable membrane extraction methods.¹²⁻¹⁴ Considerable research and development will be needed to bring these to the TRL needed for deployment in a reactor-grade facility.

- **How can tritium be efficiently processed and made available for fueling of the reactor while maintaining full accountancy, a minimum level of inventory, and avoiding release to the environment?**

The current state-of-the-art for tritium processing is the plant currently under design for ITER.¹⁵ With no further advances, a DEMO device would require on the order of a factor of four larger plant. Reducing the size and complexity and increasing the safety of this plant would have a significant impact on the cost, and so is extremely desirable.¹⁶

Superpermeable metal foil vacuum pumps¹⁷ have been proposed, that could separate hydrogen isotopes directly from the exhaust gas in the primary pumping system, thereby sharply reducing the amount of tritium sent to the processing plant. This in turn could reduce the size of a DEMO tritium plant to one similar in size to ITER's.

References

1. 2009 "Research Needs for Magnetic Fusion Energy Science," Report of the Research Needs Workshop (ReNeW) report, June 9-13, 2009.

2. 2015 *Report of the Workshop on Transients*,
https://science.energy.gov/~media/fes/pdf/program-news/Transients_Report.pdf
3. 2015 *Report of the Workshop on Integrated Simulations for Fusion Energy Sciences*, https://science.energy.gov/~media/fes/pdf/workshop-reports/2016/ISFusionWorkshopReport_11-12-2015.pdf
4. 2015 *PMI Community Workshop Report*,
http://science.energy.gov/~media/fes/pdf/workshop-reports/2016/PMI_fullreport_21Aug2015.pdf
5. J. R. Lovering, A. Yip, and T. Nordhaus, 2016 *Energy Policy* 371
6. J. E. Trancik, 2006 *Environ. Res. Lett.* **1** 014009
7. A. C. Klein, 2017 *American Nuclear Society special report* 3
8. *National Academies Study*, http://sites.nationalacademies.org/BPA/BPA_177107
9. <https://www.iter.org/mach/tritiumbreeding>
10. L. El-Guebaly, 2017 "*Neutronics and Tritium Breeding Capability for Liquid Metal-Based Blanket (DCLL)*," *TEC whitepaper*
11. B. Williams, 2017 "*Robust Cellular Solid Breeder Offering Potential for New Blanket Designs with High Tritium Breeding Ratio*," *TEC whitepaper*
12. S. Reyes, 2017 "*Enabling Capabilities for Tritium Safety: Transformative Enough?*" *Presentation to FESAC TEC panel*
13. B. Garcia-Diaz, 2017 "*Direct LiT Electrolysis in Molten Lithium*," *TEC whitepaper*
14. P. Calderoni, and T. He, 2017 "*Extraction of tritium from lithium based liquid metals*," *TEC whitepaper*
15. I. R. Cristescu *et al.*, 2007 *Nucl. Fusion* **47** 5458
16. C. Day, and T. Giegerich, 2013 *Fusion Eng. Design* **88** 616
17. M. Shimada, 2017 "*Superpermeable Metal Foil Pump for Increasing Tritium Burn-Up Fraction for DEMO*," *TEC whitepaper*

IV.I TRANSFORMATIVE ENABLING CAPABILITY: ADVANCED ALGORITHMS



* Image Credit: Laurent T / Shutterstock

4.1 Advanced Algorithms

Overview

In the same way that control advances were the key to enabling heavier-than-air flight, advances in algorithmic control solutions will accelerate research toward a viable steady state, disruption-free fusion reactor, as well as understanding of basic physics issues. These advances will transform the vision of a fusion reactor from a transient-prone experimental device to a reliable steady-state power plant, and could also help uncover powerful but presently unknown physics principles embedded within existing databases. The TEC area of Advanced Algorithms includes the closely related fields of mathematical control, machine learning, artificial intelligence, integrated data analysis, and other algorithm-based research tools. The fields that make up this TEC area are related through their use of sophisticated algorithms, often only made possible by high-performance computing technologies (see Section 6.4). These algorithms enable, enhance, and accelerate: scientific discovery through efficient data analysis, knowledge extraction from large and complex data sets, and real-time control solutions. The algorithms could be applied to aid in understanding many aspects of fusion science, e.g. confinement, turbulence, and transport.

Mathematical control is the field of mathematics that makes use of sufficiently accurate models of physical phenomena and provides theorems and methods for designing control algorithms to satisfy operational requirements¹⁻⁶. This discipline enables design of effective control, often with imperfect models, and provides methods for quantifying risk and performance under many conditions.

Machine learning (ML) derives methods for identifying predictive mappings from known inputs to known outputs in a poorly characterized system^{3, 5, 7, 8}. It enables identification of patterns and fundamental knowledge from large sets of experimental data, potentially beyond that identifiable by traditional analysis. ML tools can enhance researcher effectiveness in analyzing data, and enable design of control algorithms based on dynamics inherent in large datasets without explicit model definition. The closely related fields of artificial intelligence (AI) and expert systems enable construction of systems that embody a domain of knowledge and can make complex judgments in that domain, either to support or replace human action¹¹⁻¹⁴. In the same way that ML is transforming autonomous control^{15, 16} and revolutionizing the way pharmaceutical science is done¹⁷, this field could dramatically accelerate fusion science and energy by assisting and enhancing the discovery science process, and producing control solutions that are presently inaccessible.

Integrated data analysis (IDA) is a novel analysis methodology that embodies a probabilistically-underpinned systematic approach to mixed data analysis¹⁰. It provides a powerful framework for systematically managing limitations and uncertainties in measurements, combining all relevant information so as to reveal all of the knowledge available from a set of related measurements. While extracting maximum understanding from experiments, this methodology simultaneously quantifies the uncertainties and probabilities implied by the integration of all data available. Related approaches include frameworks for integrating raw and interpreted data with computational analysis that provides either synthetic diagnostic information or projected physics information^{10, 18}.

Other algorithmic science and technology research encompassed by this TEC area include real-time analysis of complex plasma conditions such as the plasma state and MHD stability. Faster-than-Real-Time simulation of the plasma state, coupled with real-time analysis capabilities, is one example identified as a requirement for ITER operation^{3, 19, 20}.

The closely related fields in this TEC could play important roles in solving large challenges in fusion energy development. For example, each of these fields includes powerful approaches to dealing with limitations in knowledge of underlying system dynamics and principles. Control mathematics offers systematic ways to achieve desired performance in a reactor even with gaps in the understanding of the underlying physics, provided the actuators are sufficient to access the performance, and sensors are sufficient to measure relevant parameters. Control also offers the solutions to providing robust, sustained operation of a reactor in true long-term, disruption-free steady state. Machine learning offers methods for generating useful models, even when the underlying physics is not fully understood. Expert systems enable capture, identification, and application of knowledge in particular domains even when no single person possesses such a collection. Integrated data analysis can extract maximum information from an increasingly complex combined data environment (including results of computational analysis), and produce probabilistically qualified data to characterize the uncertainty and confidence level of both experimental and theoretical conclusions. Taken together, the elements of this TEC area hold significant promise for accelerating progress of fusion research toward the realization of an attractive, practical power reactor.

Together, these TEC elements could help resolve several grand challenges on the path to a practical fusion reactor (see Grand Challenges Chapter):

- How can we ensure sufficiently robust stability (passive or active) and near-zero disruptivity in fusion reactor plasmas?
- How can a fusion reactor be made sufficiently economically attractive?
- How can we manage uncertainty and incomplete knowledge of key plasma physics elements needed for a fusion reactor?

Background

Mathematical control has a long and fascinating history, with origins traceable to Hellenistic Egypt of the 3rd century B.C.E., and the feedback-regulated water clock of Ktesibios²¹. However, the specific and effective application of mathematical techniques to control synthesis began as a formal field of research in the mid-19th century, as the growing demands of industrialization drove the development of regulatory devices such as the flywheel governor for steam engine power output²². Model-based and computational design, as well as treatment of control design and analysis as a formal branch of mathematics, had its origin between the World Wars, and grew to maturity in the post-WWII years²³. Modern multivariable, mathematical theorem-intensive, and complex model-based control theory experienced rapid growth beginning with seminal work in the U.S.S.R. in the 1960's, and dramatically accelerating through subsequent applications to commercial and military aerospace systems in the West²⁴. The most recent advances have occurred in the explosion of highly nonlinear data-driven controllers for horizon applications including autonomous cars⁵. These most recent applications make significant

use of machine learning methods, as well as hardware and firmware technologies such as GPU-enabled convolutional neural network-based controllers^{5, 7, 14}.

The magnetic fusion community has long made routine use of feedback control to operate experimental devices, beginning with analog empirically-designed proportional-integral-derivative (PID) control systems in the earliest years, and transitioning to model-based designs operating on real-time digital computer platforms beginning in the early 1990's^{25, 26}. The field has advanced significantly in the last decade through connections made between the fusion physics community and mathematical control experts in academia and beyond. Today virtually all large tokamaks operate with many CPUs executing dozens of control algorithms in parallel to regulate discharge evolution, actively stabilize instabilities

Control Operating Regime Map

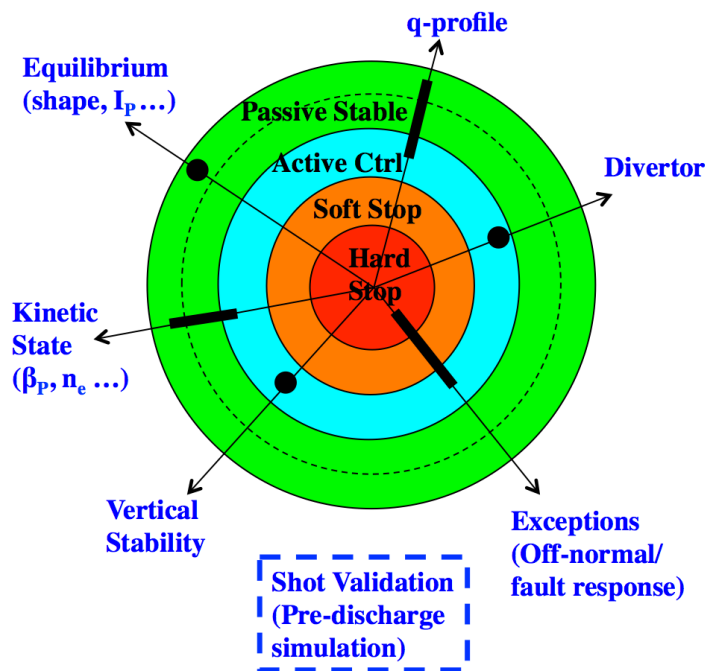

Figure 4.1.1. Effective, high-performance control is the heart of a successful fusion reactor, turning physics understanding into *reality*, and enabling sustained disruption-free operation. The Control Operating Space illustrates the level of operational controllability (colored concentric layers representing Passive, Active, or shutdown control) corresponding to each control category (represented by blue text labels). In an extreme fault the controllability may become so poor that the device must be shut down in a controlled way (Soft Stop) or in an emergency termination (Hard Stop). Ensuring robust, reliable control also requires validation of operating scenarios with simulations (Shot Validation).

(e.g. Fig. 4.1.1), and respond asynchronously to events, either for better elucidation of physics or to prevent undesirable events, e.g. disruptions^{27, 28}. Owing to the increasingly routine application of model-based control to fusion devices, advances in physics understanding and model accuracy can often be translated to control solutions that improve experimental plasma performance. Conversely, advances in control capabilities can contribute to advances in physics understanding.

Machine learning methods and tools developed from data mining and knowledge discovery mathematics began in the late 1990's but only reached the present levels of effectiveness in the mid-2000's⁷. Often said to have been stalled for some 30-40 years by a mathematical proof of the limitations of *single-layer* neural networks²⁹, the field rapidly advanced after it was realized that *multi-layer* neural networks and related nonlinear mapping functions were not limited in the same ways that Minsky and Papert had identified. Accelerated by this belated awareness, machine learning re-emerged applied to many fields,

including fusion research. As early as the mid-1990's, neural networks were being successfully applied to disruption prediction³⁰, and this approach continues to be applied to experimental data from various devices^{8, 31, 32}. Figure 4.1.2 shows an application of machine learning for self-driving cars.

While the fields included in the Advanced Algorithms TEC area generally predate fusion research and have made substantial progress independent of fusion, their mathematics and methods have been widely studied and applied to the “controlled thermonuclear fusion” enterprise since its inception. These applications have been fruitful, and in the case of control have arguably been key to the entire experimental magnetic fusion effort.

Nevertheless, realizing the promise of these related fields to transform and dramatically accelerate fusion research will require a different scale of emphasis and priority than has been applied to date. Mathematical control, machine learning, integrated data analysis (e.g. Fig. 4.1.3), and related advanced algorithmic research can powerfully inform the priority needs of all scientific research in fusion, since these fields ultimately identify the true observable and controllable characteristics of a power reactor. In addition, these methods

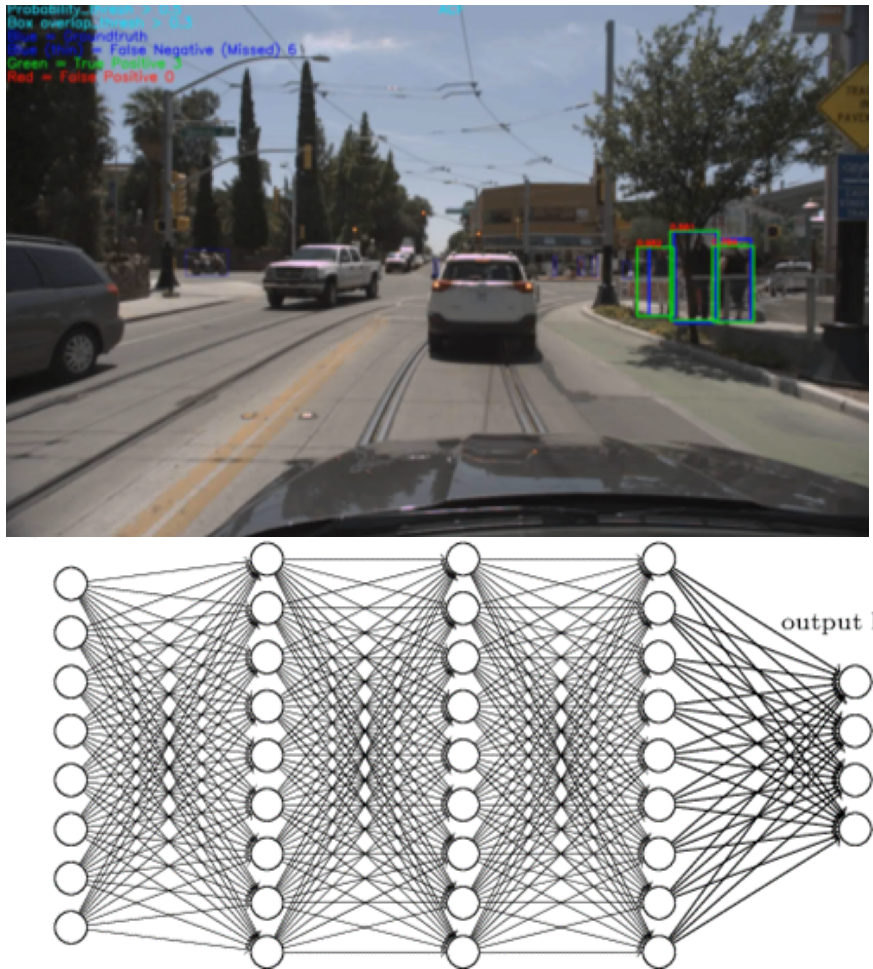

Figure 4.1.2. Machine learning embodies mathematical tools for extracting knowledge from large datasets, even when it is inaccessible by traditional means. Here a multi-layer neural network interprets a scene to identify pedestrians for a self-driving car⁵.

provide formal tools for managing physics knowledge gaps where they exist, to facilitate rapid progress toward an operating fusion power plant. They can dramatically augment researcher effectiveness, for example by providing the means for rapid discovery and development of presently unknown successful operational regimes. They constitute the best-known candidates for managing and reducing the complexity inherent in managing fusion reactor off-normal and fault events.

Although all of the technology elements of this TEC area are advancing driven by academic, commercial, and military sectors, the potential value derived from application to fusion-specific problems will be realized by R&D targeted for fusion applications.

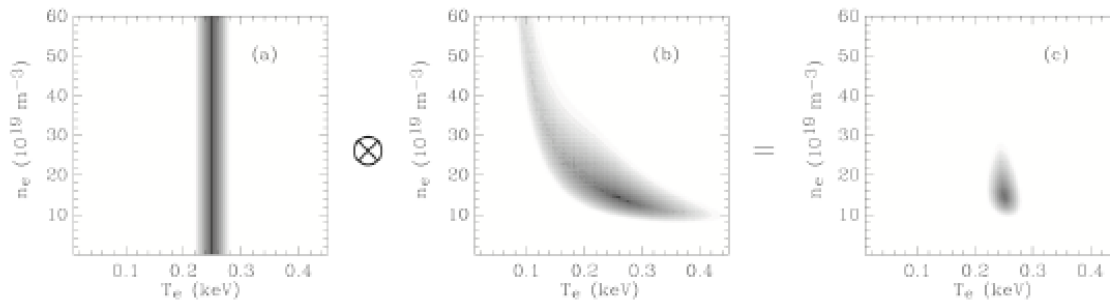

Figure 4.1.3. Probability Density Functions from a) soft X-ray data and b) Thomson scattering measurements of electron density, illustrating the combination of multiple diagnostics using a Bayesian statistical framework^{9,10}. The result of combining a) and b) is the reduced posterior PDF (lower uncertainty) shown in c) for the combined data.

4.1.1 Technology Assessment for Mathematical Control

Level of maturity: The field of mathematical control has been advancing for decades in the academic, commercial, and military sectors, and has also been accessed to varying degrees within the fusion community. For ITER and fusion reactor applications, mathematical control has reached an estimated TRL ranging from 2 to 4, depending on the specific area of controller synthesis and analysis mathematics²⁻⁶. Various aspects of mathematical control have been successfully applied to operating experimental devices, but these applications fall far short of the needs of power reactors^{19, 20, 26-28}.

Promise and development requirements: Mathematical control holds considerable promise for solving large challenges in fusion energy development. Control mathematics offers systematic ways to achieve desired performance in a reactor even with gaps in the understanding of the underlying physics, provided the actuators are sufficient to access the performance, and sensors are sufficient to measure relevant parameters. Development of this field for fusion reactor solutions primarily requires establishing and/or enhancing connections between control mathematics experts and the fusion community, strengthening focused efforts and advancing the use of exascale and high performance computing to derive optimized control-level models from high-fidelity physics codes, and supporting specific development projects with high capability for accelerating progress toward solutions for both ITER and a power reactor. Technical development steps needed for control mathematics include focused development of control solutions to address ITER and reactor performance needs with model inaccuracies; exception-handling solutions to

provide reactor-level machine protection and disruption prevention; and methods of quantifying and guaranteeing (i.e. with sufficiently high probability) required control and fault-handling performance levels.

Time horizon: Under the development path described above, the anticipated time horizon for this TEC to be brought to above TRL 6-7 for reactor application is ~10-20 years with appropriate research in synergistic and foundational areas.

Risks and uncertainties: Investment in mathematical control for fusion research acceleration carries with it a limited degree of uncertainty, primarily in the specific cost-benefit ratio anticipated in addressing various problems. While the qualitative benefits are highly certain based on the history of their development both inside and outside fusion, the degree to which investment in control will return accelerated advancement in critical grand challenge problems is uncertain.

There is also a risk inherent in the potential for insufficient foundational research, e.g. to produce the validated physics models needed for high-performance control design. The robustness of experimental and theoretical programs that incorporate and support these research paths is thus a prerequisite for reaping the benefits of the TEC investment.

Global strengths and gaps: The field of mathematical control has substantial strength in both the EU and the U.S., both inside and outside of fusion. No other ITER Party nations are in the same category of maturity and capability, although Japan has the most relevant and substantial experience among them, and may make noticeable advances with the imminent operational phase of JT-60SA. Mathematical control has world-class strength and leadership in many subfields distributed among many universities, including Lehigh, MIT, Carnegie-Mellon, and Stanford. Connections exist between U.S. fusion laboratories and several of these, but require significant enhancement. The U.S. plasma control community is well integrated among U.S. labs, as well as with the Asian superconducting devices, EAST and KSTAR, while the EU is primarily focused on ITER (although the EU has a substantial role in JT-60SA, which may have significant focus on control). This presents an opportunity for U.S. leadership toward control solutions for a power reactor. The strength of synergistic U.S. experimental and theoretical fusion programs further enhances the opportunities for leadership in the Advanced Algorithms TEC area.

4.1.2 Technology Assessment for Machine Learning and AI

Level of maturity: Having benefited from significant advancement in academic, commercial, and military domains in recent years, machine learning and artificial intelligence (in their recent revolutionary forms) are relatively new fields with strong potential to advance fusion energy development if substantial investment is provided. Just as machine learning enabled the spectacular leap from limited performance human-programmed cars to fully autonomous commercial vehicles in roughly two decades^{33, 34}, these fields hold great promise for transforming the fusion enterprise. The principal need is to connect the expert communities in the fields with the relevant fusion communities, and to focus efforts on producing dedicated solutions to fusion problems. Machine learning applications to fusion are in their infancy, perhaps at TRL ranging from 1 to 3, depending on the specific technology and algorithmic science involved^{5, 7}. However, in the specific

domain of disruption prediction and alarm signal generation for presently operating devices, an achieved TRL range of 3 to 6 has been estimated^{3, 8, 32}.

Promise and development requirements: As in the case of control, machine learning and artificial intelligence also include powerful approaches to dealing with limitations in knowledge of underlying system dynamics and principles. Machine learning in particular offers methods for generating useful models even in the presence of gaps in physics knowledge. The field also holds the potential for extracting physics understanding from very large collections of data, inaccessible by traditional approaches. For example, buried in the collective data of the world's operating tokamaks and potentially accessible via machine learning may be knowledge of the optimal machine-independent current and pressure profiles providing high performance with robust stability to all ideal and resistive modes. The capabilities of this TEC area constitute transformational tools for researchers that support, enhance, and accelerate the scientific process of knowledge discovery. Technical development steps needed to realize the promise of machine learning applied to fusion include global-scale data formatting, access and analysis capability for extraction of new knowledge from large experimental and simulation-derived datasets, and establishment of existence proofs for effective predictability and controllability of critical plasma phenomena. As in the case of mathematical control, connections between the machine learning and fusion communities must be established, and specific development projects are required to extend and tailor relevant algorithms to fusion and to apply these approaches to solving fusion problems. Although machine learning offers methods for dealing with data uncertainty and noise, the value and effectiveness of these methods for knowledge discovery will be maximized if substantial effort is applied to quantifying and verifying fusion data quality on a large scale prior to analysis (this applies to both experimental and simulation-derived data).

Time horizon: Owing to its high maturity in the academic and commercial sectors, the anticipated time horizon for this TEC area to be brought to above TRL 6-7 for reactor application is ~10 years with appropriate research in synergistic and foundational areas.

Risks and uncertainties: Development of machine learning and AI fields for acceleration of fusion research implies uncertainties in the degree of reward for a given level of investment. These fields also depend on matching research advancements in other areas. For example, advancement in certain elements of high performance computing will be important, potentially including development of technologies such as real-time GPU's and real-time many-CPU clusters. In addition, the underlying principles of machine learning and AI are still being identified; thus, close coupling between the computer science and fusion science experts will be necessary.

Global strengths and gaps: Machine learning is a dominant strength of the U.S., primarily through leadership of universities such as Carnegie-Mellon and industrial dominance from corporations including IBM, Google, and other Silicon Valley centers of expertise. This provides significant opportunities for establishing joint projects between the fusion community and both universities and corporations with unique expertise. The principal development gap requiring bridging through TEC investment is the lack of such connections and exploitation of the deep expertise resident in the U.S.

4.1.3 Technology Assessment for Offline and Real-time Data Handling Algorithms

Level of maturity: Integrated data analysis and various other algorithmic capabilities relevant to ITER and power reactors are at a very early level of maturity, estimated^{10, 18} at TRL ranging from 2 to 4.

Promise and development requirements: Systematic methods for offline and real-time data handling, including Integrated Data Analysis and Faster-than-Real-Time-Simulation, hold significant promise to transform the quality and amount of information extractable from measurements. The primary development requirement is investment and focused efforts in advancing the technology itself and expanding the application of these methods to fusion experiments. This element of Advanced Algorithms depends no less critically on data quality, and therefore requires similar attention to data verification and uncertainty quantification efforts as the other TEC elements.

Time horizon: Under the development path described above, the anticipated time horizon for this TEC area to be brought to above TRL 6-7 for reactor application is ~10-15 years with appropriate research in synergistic and foundational areas.

Risks and uncertainties: Pursuit of this TEC area shares the class of risks and uncertainties implicit in control and machine learning. There is uncertainty in the cost and benefit of developing Faster-than-Real-Time-Simulation, as well as risk that experimental research efforts will be insufficient to integrate and apply the tools.

Global strengths and gaps: The international community has limited expertise in Integrated Data Analysis, but somewhat greater expertise and ongoing efforts in various other data-handling algorithms, including Faster-than-Real-Time-Simulation and online stability calculation. Nevertheless, all of these related areas represent strengths of the U.S., ranging from highly competitive to world-leading expertise. Unlike the fields of control and machine learning, the relevant expertise resides primarily in the fusion community at present, and therefore depends fusion research in order to advance.

References

1. J. M. Maciejowski, 1989 "*Multivariable Feedback Design*," Addison-Wesley, Wokingham, England
2. N. Eidietis, 2017 "*Transformative Disruption/Mitigation Solutions*," TEC whitepaper
3. E. Kolemen, 2017 "*Real-time stability analysis and control for disruption-free operations*," TEC whitepaper
4. A. Scheinker, 2017 "*Adaptive feedback control for automated plasma diagnostics and control systems*," TEC whitepaper
5. J. Schneider, 2017 "*Machine learning, artificial intelligence, and robotic reasoning*," TEC presentation
6. E. Schuster, 2017 "*Reactor-like Control integration by model-based real-time optimization*," TEC whitepaper

7. K. P. Murphy, 2012 *"Machine Learning: A Probabilistic Perspective,"* MIT Press, Cambridge, MA
8. R. Granetz, 2017 "Machine Learning methods applied to disruption prediction," *TEC whitepaper*
9. R. Fischer, 2003 *Plasma Phys. Control. Fusion* **45** 1095
10. L. Reusch, 2017 "Developing integrated data analysis techniques to optimize diagnostics for burning plasmas," *TEC whitepaper*
11. A. Constantinou, 2016 *Artificial Intelligence in Medicine* **67** 75
12. D. Ferrucci, 2013 *Artificial Intelligence* **199** 93
13. S. J. Russell, 2014 *Artificial Intelligence: A Modern Approach,* Pearson Education, Essex, UK
14. A. Saxena, 2016 "How AI Can Automate Our Lives," *Structure Data Conference 2016;* <https://vimeo.com/159939784>
15. 2016 *Science* **354** (6311) 426, doi: 10.1126/science.aal2546
16. 2017 "AI is Changing How We Do Science," *Science Online,* doi: 10.1126/science.aan7049
17. E. Putin, "Deep biomarkers of human aging: Application of deep neural networks to biomarker development," <http://pubs.acs.org/doi/abs/10.1021/acs.molpharmaceut.6b00248>
18. M. Churchill, 2017 "Accelerating fusion science with an end-to-end analysis framework for remote, large-scale, near real-time analysis," *TEC whitepaper*
19. D. Humphreys *et al.*, 2015 *Phys. Plasmas* **22** 021806
20. J. A. Snipes *et al.*, 2017 *Nucl. Fusion* **57** 125001
21. J. G. Landels, 1978 "Engineering in the Ancient World," *Univ. of Calif. Press,* Berkeley, CA
22. S. Bennett, 1986 "A History of Control Engineering 1800-1930," *Institution of Engineering and Technology,* London, UK
23. S. Bennett, 1993 "A History of Control Engineering 1930-1955," *Institution of Engineering and Technology,* London, UK
24. G. Franklin, 2014 "Feedback Control of Dynamic Systems," *Pearson,* Stanford, CA
25. J. Ferron, 1991 "An Advanced Plasma Control System for the DIII-D Tokamak," *Proc. of 14th IEEE/NPSS Symp. on Fus. Eng.* **1** 761
26. E. A. Lazarus, J.B. Lister, and G. H. Nielson, 1990 *Nucl. Fusion* **30** 111
27. B. Penaflor, 2008 *Fusion Eng. Design* **83** 176
28. W. Treutterer, 2014 *Fus. Eng. Des.* **89** 146
29. M. Minsky, and S. Papert, 1969 "Perceptrons," *MIT Press,* Cambridge, MA
30. D. Wroblewski, G.L. Jahns, and J. A. Leuer, 1997 *Nucl. Fusion* **37** 725
31. B. Cannas *et al.*, 2004 *Nucl. Fusion* **44** 68
32. C. G. Windsor *et al.*, 2005 *Nucl. Fusion* **45** 337
33. T. M. Jochem, D. A. Pomerleau, and C. E. Thorpe, 1995 "Vision Guided Lane Transition," *IEEE Symposium on Intelligent Vehicles, September 25-26, 1995,* Detroit, Michigan, USA
34. D. A. Pomerleau, 1993 "Neural Network Perception for Mobile Robot Guidance," *Kluwer Academic Publishing*

IV.II TRANSFORMATIVE ENABLING CAPABILITY HIGH CRITICAL TEMPERATURE SUPERCONDUCTORS

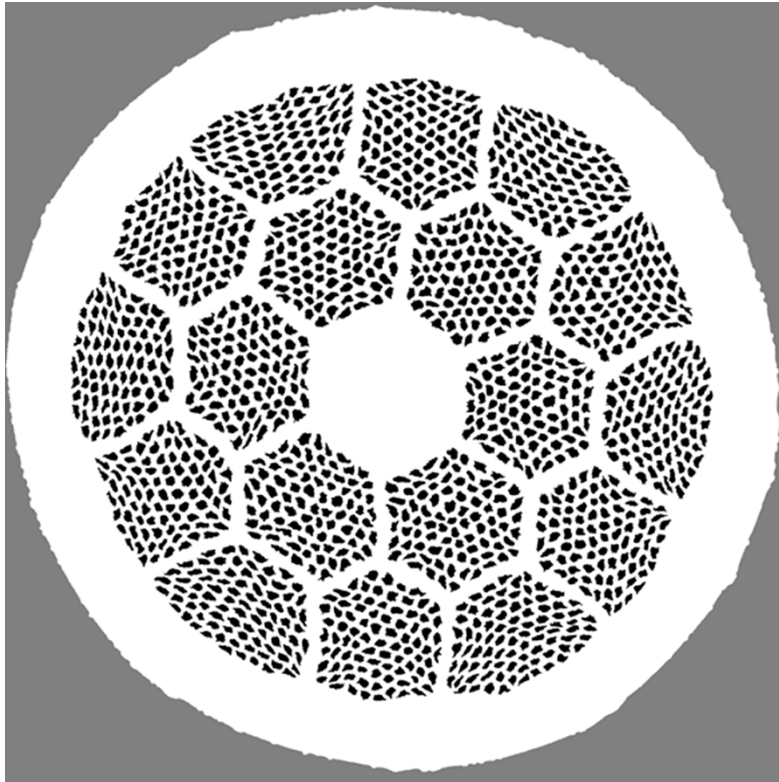

Bi-2212 strand cross section

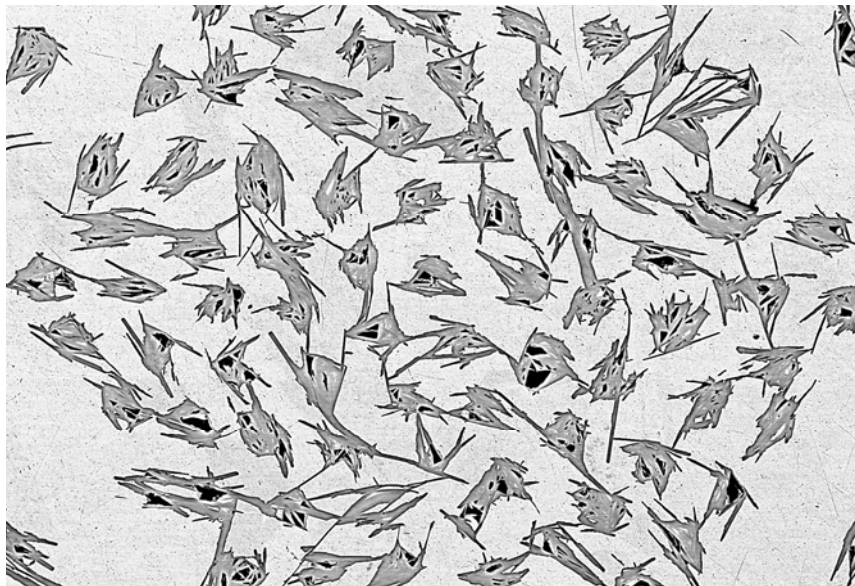

BSCCO Powder

Jianyi Jiang, Applied Superconductivity Center, National High Magnetic Field Laboratory

4.2 High Critical Temperature Superconductors

Overview

Magnet systems are the ultimate enabling technology for magnetic confinement fusion devices. High field magnets, essential for efficient operation of these devices depend on the use of superconducting magnets. Advances in the development of superconductors that operate at higher temperature and/or higher field, referred to as HTS, present a potentially game-changing opportunity to significantly enhance the performance and feasibility of a large variety of magnetic confinement devices. The transformative aspect of HTS comes from the potential to generate and maintain magnetic fields beyond currently available technology and significantly reduce the time and cost for next-generation devices and experiments to come online for fusion power generation. The ability to operate at higher temperatures that comes with the use of HTS opens the possibility of incorporating demountable joints that would enable greatly improved access for construction and maintenance. Access to higher fields would result in smaller, more compact burning plasma experiments, improving the cost-performance ratio by allowing high energy gain and power density in much smaller devices and would thus have a positive impact on future commercialization. HTS cables offer the promise of expanding the design space available for reactor design. Although a compact reactor also has limitations due to complex coupled and interacting constraints, future technology advances (such as the materials, manufacturing, and liquid metal surfaces addressed in other parts of this report) may relax these constraints in unforeseen ways.

Since the discovery of high-temperature superconductivity in the late 1980's, development and investment by Office of Energy Efficiency and Renewable Energy (EERE) and the DOE Office of High Energy Physics (OHEP) has resulted in superconductors that can now be considered for high field magnetic fusion applications. The high field and temperature properties of HTS allow the possibility of eliminating cryogenics¹ and enabling the use of demountable resistive joints². In addition, the high critical temperature could also allow operating in a nuclear heating environment significantly higher than allowed in low-temperature superconductor (LTS) magnets.

4.2.1 High Field HTS Magnets

Background

There are two primary HTS materials that are sufficiently mature for the next step of magnet development: rare-earth barium copper oxide (REBCO) tapes (Figure 4.2.1) and Bi-2212 round strands (Figure 4.2.2). Iron-based superconductors³ are on the horizon, and with a breakthrough could be a candidate within the next decade or so. REBCO superconductors carry sufficient current density for magnet applications at fields up to 100

T^{4,5}. REBCO has been successfully used to reach fields over 40 T in solenoids⁶ and has achieved⁷ engineering current densities exceeding 1000 A/mm². This is an order-of-magnitude higher current density compared to LTS equivalent fusion magnets. This capability leads to much smaller magnets for the same magnetic field, used to great advantage in compact all REBCO NMR user magnets at fields over 35T now under construction⁸. This exceeds the requirement of ~20T as embodied in compact high-field tokamak designs. REBCO can operate at over 90K but performs much better at lower temperatures and thus high-field fusion and accelerator magnets often target 20-30K. The significance of the high-temperature operation goes well beyond the thermodynamic advantages in the cryogenic system. Operation at temperatures significantly above those limited by liquid helium, and the relative insensitivity of the critical current to temperature, results in magnets with much higher operating stability — a critical consideration for the long-life operation required in a dynamic fusion environment. Further, these properties have enabled some REBCO magnets to forgo incorporating electrical insulation. REBCO's primary constituent material (~50-90% by volume) is high-strength nickel alloys or steels. REBCO has been shown to remain superconducting at stresses over 600 MPa and strains up to 0.45%⁹, a factor of 2 - 3 improvement over LTS. Several studies have verified that REBCO has similar resistance to neutron damage as Nb-Ti and Nb₃Sn^{10,11}.

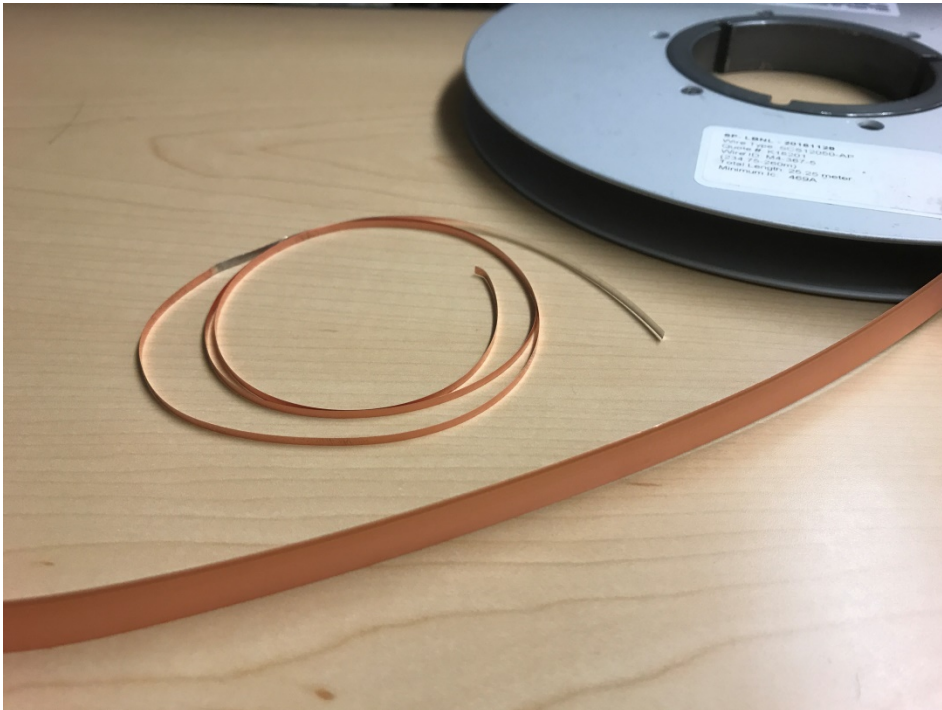

Figure 4.2.1. Two commercial tapes from SuperPower: 12 mm wide, 100 μm thick tape and 2 mm wide, 45 μm thick tape.

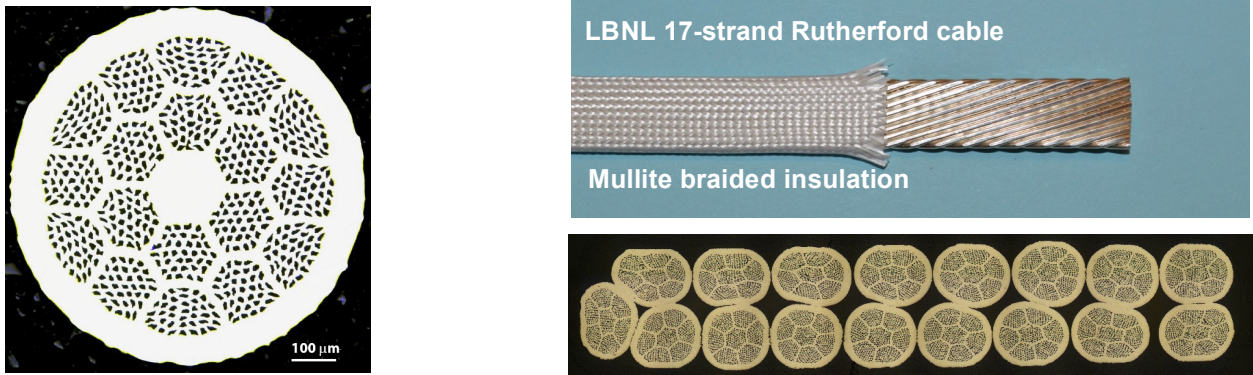

Figure 4.2.2. Bi-2212 strand cross section and Rutherford cable.

REBCO does not require any subsequent heat treatment, resulting in simpler coil fabrication relative to materials that require heat treatment subsequent to winding. Bi-2212 is another possible candidate with the advantage of being available as a round strand and the electrical and magnetic properties compare well with REBCO. However, Bi-2212 requires a rather complex, high-pressure heat treatment and has poor mechanical properties. The high silver content (~75%) also makes it less attractive for fusion applications. It is still possible that with further cable development it could be used in pulsed magnet systems.

Level of Maturity: The present performance of commercially available REBCO tape is already sufficient for use in practical fusion experimental devices now. The field generation depends on the engineering current density J_e , (the maximum transport current per unit area of the conductor cross section). J_e above 1000 A/mm^2 at 31 T, 4.2 K has been demonstrated on short REBCO tape, highest among all the technical superconductors⁷. High current density HTS cables consisting of multi-layered REBCO tapes have achieved >10 kA at 4-20 K operation in tests of short samples. High current density Roebel cables and CORC[®] wires using YBCO (Yttrium Barium Copper Oxide) tapes are being designed for coil applications in high field magnets, as well as accelerator magnets. However, at this point, there has been much less effort focused on development toward the needs for fusion magnets. The standard design of <1 cm thick CORC[®] cable with a critical current at 4.2 K, 20 T of about 8-12 kA has >250-350 A/mm^2 overall engineering current density in tests of short samples. The cable is robust and flexible but the packing density needs improvement in order to achieve an overall current density in the coil of 70 - 100 A/mm^2 desired for compact fusion magnets. The next steps forward involve further identification and characterization of the range of electrical and mechanical performance parameters of HTS in parallel with the design and engineering of coil packs and support structures devised for optimal stress/strain distribution in high field compact fusion magnets.

The high aspect ratio tape geometry and superior tensile strength makes REBCO tapes a natural conductor to develop pancake coils. More complex coil geometries are not excluded, but would require further development. As a result, operation of HTS materials

has already been demonstrated for small-bore superconducting magnets at fields, current densities, stresses and $J \times B$ forces larger than required for fusion magnets. The current field record is 26 T generated by an all-REBCO magnet operating at 4.2 K¹². A 32 T all superconducting user magnet, with 17 T contributed by REBCO pancake coils, is under development at the National High Magnetic Field Laboratory, Florida State University⁸.

Commercially available HTS conductor based on REBCO must be packaged into high current cable, suitable for a large volume, high-field fusion magnet system. It must then be incorporated into large bore magnets along with the engineering systems required to safely operate the magnet with significant stored energy. The challenges in this area are primarily electro-mechanical in nature involving integrated mechanical engineering of high-strength structures and manufacturing and assembly processes.

Several cable concepts have emerged and prototype cables are being characterized. The behavior of the brittle REBCO conductors, the impact on cable performance and optimization of the cable design are still being investigated. Due to the scale of fusion magnets, it is necessary as well as efficient to use a cable test facility to characterize and qualify the cable designs under conditions relevant for fusion magnets. A domestic high-field cable test facility would significantly benefit REBCO cable R&D with quicker turnaround and lower cost.

Several publications and reports present an outlook identifying the general advantages and challenges of using REBCO conductors for future reactor magnets^{4, 13}. MIT recently proposed a design of a compact fusion device featuring REBCO TF coils with a peak field² of 23 T. Several REBCO cable concepts are under active development and prototype cables are undergoing testing¹⁴⁻¹⁷.

At present, HTS magnets have not been tested in the configuration or at the scale needed for fusion experiments. This technology is at TRL 3. Key challenges include magnet quench detection and protection, conductor stress/strain management and characterization of radiation resistance. There is consensus within the magnet community that existing high-strength stainless steel and superalloy materials are adequate for projected fusion requirements.

Promise and development requirements: Development of fusion-class magnets at the appropriate fields would require a significant integrated effort due to the cost of the materials and the scale required. Considerable work is being done in the U.S. and Europe on cable development. Fusion is not driving or leading the development of REBCO, which is primarily driven by large industrial markets in MRI, fault current limiters, transmission lines, motors and generators. REBCO represents a large value proposition in these markets and adoption will drive production up and cost down, benefiting fusion. The DOE OHEP and EERE are supporting further improvement on conductor performance. This presents an opportunity for the Fusion community to leverage investment in development.

Although REBCO is extremely stable in operation, quench detection is a significant issue due to very slow propagation of the normal zone. The present method is to use inductively balanced voltage taps, which have significant limitations. Therefore, further R&D of robust, innovative methods for quench detection is required.

The Fusion community is ready to move toward a full scale REBCO fusion magnet for tokamaks. By leveraging outside efforts and taking advantage of the rapid progress of HTS material performance, it would be possible to design a fusion coil that would generate high confidence that HTS magnets could be successfully demonstrated at large scale. The estimated time/cost for design and construction of a prototype magnet is 3-5 yrs.

The next step would involve scale-up and integration of components and technologies currently under development, such as cables, into a full-size fusion-class magnet. Due to the scope of such a project it would benefit from a collaborative effort of several institutions. The U.S. has the necessary infrastructure and capabilities to take the lead in such a project. The magnet development work should be complemented by a parallel program in device design specifically targeted toward the use of HTS.

Time horizon: HTS conductor technology is currently at the stage of performance improvement and investigating ways to significantly lower fabrication cost. In spite of the significant progress made on HTS and its performance validation, there are open gaps to implement critical components such as high current cables, radiation tolerant insulation and high-strength structural materials into fusion magnet design. The path to integrate HTS magnet components for fusion is clear, but integration with an operating plasma environment should also be addressed.

REBCO magnet technology, which is currently at TRL3-4, could advance significantly within the next few years, assuming active development and significant progress through the collaboration of various magnet programs with public and private efforts. For example, REBCO fusion magnet technology has strong synergy with HEP magnet technology in several key aspects, e.g. the high-current cable concept, the magnet design and analysis to sustain high Lorentz loads on the conductor, and magnet protection. Leveraging HEP magnet R&D can help achieve higher readiness levels sooner for REBCO fusion magnet technology. Lawrence Berkeley National Laboratory (LBNL) is developing high-field REBCO accelerator magnet technology as part of the U.S. National Magnet Development Program supported by the OHEP¹⁸. Collaborations have already begun; the LBNL and MIT groups have initiated discussions on HTS technology needs for the fusion community that will help make the most of OFES and OHEP investments. EERE has recently funded major REBCO manufacturers and relevant REBCO material programs to develop conductors for the next-generation electrical machines operating at liquid nitrogen temperature¹⁹. This has the potential to generate a large market that can reduce REBCO conductor cost.

At present, little fusion effort is dedicated to targeted R&D of HTS technology integration to close gaps among critical components. However, fusion will benefit in many aspects through R&D advances of HTS technology in high-energy physics and the high field research magnet community. The fusion community, however, needs to specify the unique requirements for conductor, cable design and implementation steps for HTS coil technology for initial large-scale applications.

Improved conductor performance and lower cost HTS are expected in the next 3-5 years. Since much of the remaining work is engineering development as opposed to basic R&D, fabrication and test of a coil design integrating HTS components for fusion can be achieved within the next 5-10 years given adequate resources and a focused R&D effort.

Risks and uncertainties: The relatively high conductor cost is an obstacle to the otherwise potentially rapid development and demonstration of REBCO magnets. Worldwide, 15 vendors are competing to supply commercial REBCO tapes with piece lengths ranging from a few hundred meters to a few kilometers. For a fusion magnet, the typical cable lengths are 200-700 m (ITER is 700 m). REBCO tapes are regularly available in these lengths and is approaching continuous lengths up to 4 km. Development of cables with current sharing (necessary for high current cables in any case) would mitigate the requirement for long lengths.

At production levels anticipated in market adoption or for a fusion device, REBCO manufacturers and market researchers predict costs to become competitive^{20, 21}. The cost/performance ratio of REBCO tapes is projected to be lower than \$10/kA-m (a factor of 50 less than current cost) when a production level of 5000 km per year is attained²². Combining the recent and ongoing improvements in overall current density and manufacturing scale-up potential, this seems feasible and makes REBCO a competitive conductor choice when taken in the context of overall plant cost.

A compact fusion reactor requires on the order of 5,000,000 kA-m of tape. Current single manufacturer annual production is approximately 1/50th of this but is scaling fast with doubling rates of a few years²². There are multiple manufacturers increasing competition and total production. A typical production rate is 800m/50h but a capital investment of ~\$10M would be sufficient for most companies to make a factor of 2 - 4 increase in production.

The engineering current density, in-field performance, cost, yields and lengths continue to improve year-to-year by large factors (up to 10x in performance are now in the R&D pipeline). Thus, the opportunity for improvements in fusion magnets will continue to grow and a successful demonstration of the use of HTS by Fusion and/or HEP would benefit and encourage adoption by industry. However, currently there are few (if any) external or industrial drivers for developing this technology, and so development at this time will have

to be supported from government programs.

Higher strength structural materials (beyond present-day GPa yield strength limit in stainless steel) for acceptable stress limits need to be developed in combination with coil shape optimization for enhanced stress management. High radiation tolerant materials need to be identified as fast neutron exposure will reach levels of 5-10x that expected in ITER. A compact reactor could also result in challenges in handling divertor heat flux and exhaust. The quench detection and protection needs to be addressed. The angular dependence of the critical current is, improved under fast neutron irradiation up to 2.3×10^{22} n/m², but the long-term impact of radiation on conductor performance remains open and is critical to machine performance and system cost.

Global strengths and gaps: Currently, the U.S. leads the world in high quality REBCO conductor R&D, industrialization with tape manufacturers, and magnet technology development, but faces serious competition from Europe and Asia. The challenge that remains is to utilize HTS technology in the design of fusion reactors. The U.S. is currently in a position to take the lead on this development path despite having relinquished superconducting fusion device design and operation to Europe and Asia. With the advent of REBCO HTS the U.S. can perform world-leading experiments at small size and modest budget that will not bankrupt the program and provide needed diversity in experimental scale and mission. This presents an extraordinary opportunity to become world leaders.

Recognizing the significant potential of REBCO fusion magnets, other nations are quickly developing REBCO conductor and magnet technology, challenging the leading position held by the U.S. Conductor manufacturers in Europe, Asia and Russia are competing with the U.S. vendors. In Europe, the Swiss Plasma Center and ENEA in Italy are actively developing REBCO fusion cable technology. The National Institute for Fusion Science in Japan has demonstrated²³ 100 kA class REBCO cables at 4.2 K. The Institute of Plasma Physics in China has demonstrated subscale D-shaped coils using single REBCO tapes²⁴.

European researchers have recently completed a four-year R&D project named Eurotapes, aiming at integrating the latest HTS developments into an optimal conductor architecture for reduced cost with a pre-commercial target of 100 €/kA-m²⁵. Gaps between high performance HTS tapes and high field magnet design exist here that could be potential opportunities for U.S. investment via research partnership collaboration. A potential collaboration can be targeted at the integration of this and other high-performance tapes into HTS coil design for compact fusion reactors.

China has focused its government programmatic priority on Bi-2212 for its next step reactor (CFETR); Korea is supporting K-DEMO. A private company²⁶ in the UK is also working on an HTS device.

REBCO magnet technology is a strategic and transformative R&D area for magnetic-

confinement fusion energy science. It has synergy with, and can leverage, other ongoing REBCO magnet programs for HEP and power applications. The U.S. can and should lead the development of REBCO magnet technology for the next-generation fusion device.

4.2.2 Demountable Joints

Background

An additional consequence of the high thermal margin of HTS is that it would allow the use of demountable joints. For tokamaks and stellarators, demountable toroidal field coils would allow vertical maintenance on components internal to the TF coils, greatly simplifying installation, maintenance, and replacement of internal components. More frequent maintenance and replacement would reduce the first wall survivability concerns, both in terms of PMI and neutron damage²⁷. While mainly envisioned for tokamaks and stellarators, this technology would be applicable to any device where rapid disassembly would be valuable.

Level of maturity: Bench top HTS superconducting joints built and tested at MIT and NIFS have demonstrated joint resistances that would likely be acceptable, but more experiments are required to collect performance data for all of the joint designs. This technology is currently at TRL4. Medium-sized TF coils with copper joints have been built and successfully operated in the Alcator C-Mod and DIII-D tokamaks, in a practical demonstration of a mechanical joint solution at high magnet stress in the case of C-Mod, and illustrating the utility of vertical maintenance in the vacuum vessel upgrade from D-III to DIII-D.

Promise and development requirements: The goal of demountable joints for superconducting coils is to greatly simplify maintenance on a fusion device. Without a reactor-type fusion device to which to compare maintenance schemes, a reasonable first demonstration would be to operate a superconducting coil at full field without exhibiting an unacceptable increase in joint resistance or degradation to the structural integrity of the magnet and a relevant number of assembly and reassembly cycles. With HTS operating at low temperatures the design metric is setting the size of the steady-state cooling system based on economics as opposed to the LTS situation being determined by the requirement of removing heat fast enough to avoid a quench. Bringing this technology to TRL6 would require exploring joint topologies in bench top experiments and finally the construction of a facility that could test fusion-relevant HTS coils.

Time horizon: Most of the infrastructure to build and test benchtop-scale joints already exists, primarily at the National High Magnetic Field Laboratory and at MIT.

Risks and uncertainties: So far, support of HTS magnet development in general has been limited, and a more aggressive and comprehensive R&D program is needed. Demountable

joints are largely fusion-specific as there is limited benefit to current commercial applications to leverage from. The most demountable coil work to date has been performed at NIFS in Japan in the context of the FFHR design, although it is still in the preliminary stage. It is generally considered by those working in this area that demountable joints could be built, but a successful design must be robust, reliable and have low joint resistance, i.e. low heat generation, in order to be justified.

Global strengths and gaps: The only country besides the U.S. which has been seriously investigating demountable joints is Japan through the NIFS, although this program is also limited in scope. Thus, there is a large gap in global development in which the U.S. could become world leaders in this technology.

References

1. S. Awaji, 2017 *Supercond. Sci. Technol.* **30** 065001
2. B. N. Sorbom *et al.*, 2015 *Fusion Eng. Des.* **100** 378
3. M. Putti, 2010 *Supercond. Sci. Technol.* **23** 034003
4. W. H. Fietz, 2013 *Fus. Eng. Des.* **88** 440
5. D. Larbalestier, 2001 *Nature* **414** 368
6. S. Y. Hahn, 2017 *Presented at MT25, Sept. 2017* to be published
7. V. Selvamanickam, 2017 *Presented at the Low Temperature and High Field Superconductor Workshop, Santa Fe, NM, February 2017*
8. H. W. Weijers, 2016 *IEEE Trans. Appl. Supercond.* **26** 4300807
9. C. Barth, G. Mondonico, and C. Senatore, 2015 *Supercond. Sci. Technol.* **28** 045011
10. J. Emhofer, M. Eisterer, and H. W. Weber, 2015 *Supercond. Sci. Technol.* **26** 035009
11. R. Prokopec, 2014 *Supercond. Sci. Technol.* **28** 014005
12. S. Yoon, 2016 *Supercond. Sci. Technol.* **29** 04LT04
13. D. G. Whyte *et al.*, 2016 *J. Fusion Energy* **35** 41
14. G. Celentano, 2014 *IEEE Trans. Appl. Supercond.* **24** 4601805
15. M. Takayasu, 2012 *Supercond. Sci. Technol.* **25** 014011
16. D. Uglietti, 2015 *Supercond. Sci. Technol.* **28** 124005
17. D. C. van der Laan, 2011 *Supercond. Sci. Technol.* **25** 14011
18. S. A. Gourlay, 2016 "The U.S. Magnet Development Program Plan," <https://science.energy.gov/~media/hep/pdf/Reports/MagnetDevelopmentProgramPlan.pdf>
19. 2016 DOE Office of Energy Efficiency and Renewable Energy press release. November 28, 2016. <https://energy.gov/eere/articles/energy-department-announces-nearly-25-million-enable-innovative-electrical-motors-used>
20. *Superconductor market growth report*
21. 2014 SuNAM presentation to WAMS 2014, see slides 22,23,39,41
22. V. Matias, and R. H. Hammond, 2012 *Physics Procedia* **36** 1440
23. Y. Terazaki, 2015 *IEEE Trans. Appl. Supercond.* **25** 6977909
24. L. Ren, 2016 *IEEE Trans. Appl. Supercond.* **26** 6601406
25. <http://www.eurotapes.eu/>
26. <https://www.tokamakenergy.co.uk/>
27. B. N. Sorbom, 2017 "Demountable Superconducting Magnet Coils," TEC whitepaper

IV.III TRANSFORMATIVE ENABLING CAPABILITY ADVANCED MATERIALS AND MANUFACTURING

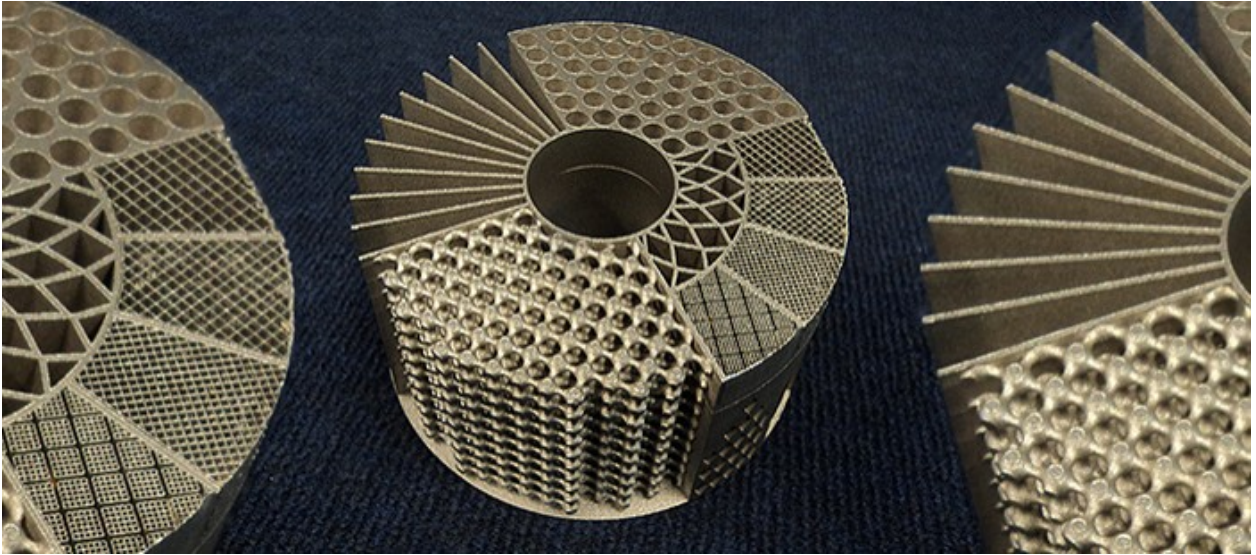

<https://lockheedmartin.com/m/us/news/features/2014/additive-manufacturing.html>

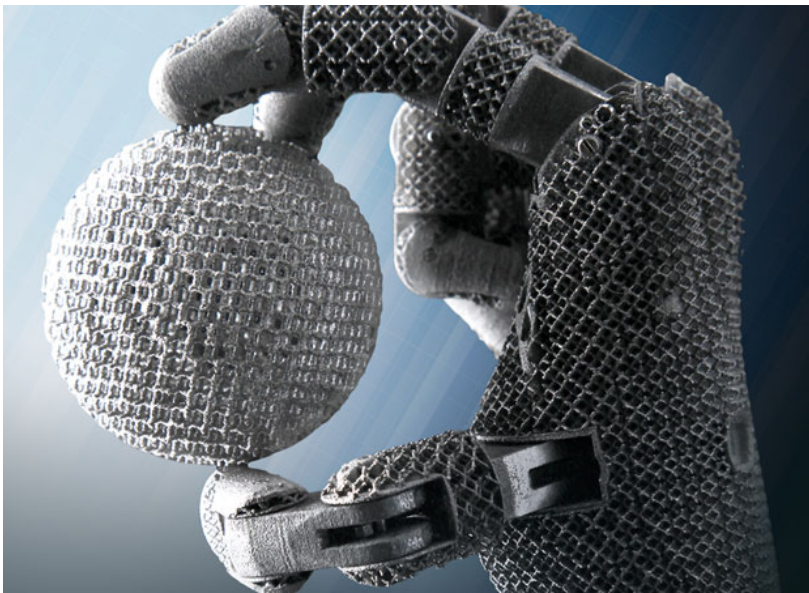

http://nfpahub.com/news/wp-content/uploads/2015/02/ORNL_additive_mfg.jpg

4.3 Advanced Materials and Manufacturing

Introduction

Plasma facing components, actuators, blankets, and structural materials for magnetic thermonuclear fusion must survive and safely perform their intended functions in an extremely hostile environment that includes high heat flux, plasma particle flux, and volumetric damage associated with a flux of high-energy neutrons. The plasma strongly perturbs material surfaces through erosion, redeposition, and implantation of hydrogen and helium particles. The eroded material redeposits continually as complex-bonded thin-films whose properties can change over time, given their evolving surface morphology and composition. This evolving plasma-facing interface can have significant ramifications for fuel recycling, impurity emission and overall machine operation. Interaction of fusion neutrons with structural materials produces residual point defect clusters and both solid and gaseous transmutation products in the bulk that can have significant effects on thermo-mechanical properties. Intense heat loads lead to high material operating temperatures and significant thermal gradients that effectively couple bulk damage evolution with the physical processes governing near-surface material evolution. Additional fusion materials challenges include: corrosion and fatigue damage caused by neutron loading and mechanical loading on structural and blanket materials, as well as on actuators operating in similar extremes. Similarly, high-field strength magnets must survive neutron degradation and require advancements in the strength and ductility of the magnet structural support components. Current conventional materials cannot meet the stringent requirements expected under reactor-relevant conditions of radiation, temperature, stress and pressure. New material design and processes are critical to enable design of materials capable of sustaining the above-mentioned conditions.

Advances in novel synthesis, manufacturing and materials design are providing for some of the most promising transformation enabling technologies in PMI and nuclear fusion materials to enable fusion energy for the future. In this chapter we summarize some of the most salient transformational technologies in advanced materials development enabled by advanced/additive manufacturing.

Background on Advanced and Additive Manufacturing

Advanced Manufacturing refers to multiple technologies that are emerging and rapidly evolving as the industrial manufacturing route of choice for fabricating components with features not readily achievable by conventional processing technologies. The novel features enabled by advanced manufacturing include complex geometries and transitional structures, often with materials or constituents that are refractory and/or hard to machine¹, the potential for local control of microstructure², and rapid design-build-test iteration.

Additive manufacturing (AM), or 3D printing, methods have become the most popular and versatile of these emerging manufacturing techniques. At its core, these methods revolve around the ability to place material and structure where desired in a bottom up, layer-by-layer fashion, as opposed to material removal methods such as machining and etching. There already exists a large suite of commercially available additive manufacturing tools capable of fabricating materials ranging from polymers to metals and even ceramics in

some limited cases, and with feature sizes ranging from 200 nanometers up to tens of centimeters. Additionally, research groups and start-up companies around the world are rapidly advancing the technologies to have capabilities such as mixed material printing, multi-scale features, and overall part sizes in the many-meter range. To date, AM is seeing multibillion-dollar investments in the commercial sector as evidenced by General Electric's recent acquisitions of Concept Laser and Arcam³, two of the world's preeminent metal AM machine providers.

Additive manufacturing tools represent a new, rapidly evolving, and powerful paradigm for component and material production. Because AM tools require little setup time and minimal fixturing, they make possible the production of any quantity at the same cost per unit, and also allow easy, rapid switching between designs and, in some cases, materials. As a result, AM is often said to be enabling "mass customization" as opposed to mass production. Additionally, a 3D additive printer can fabricate in a single piece an object that would otherwise have to be manufactured in several parts and then assembled. Because it composes objects layer-by-layer, instead of carving them from larger blocks, AM could considerably reduce waste generation associated with standard production methods.

Although in many industrial sectors, companies are pushing for AM to challenge more conventional mass production methods (e.g. GE Aviation), it is generally accepted that current printing machines are most suited to low volume, high value, high complexity, bespoke components. This is ideal for the foreseen needs of the first fusion reactors. Consequently, we will focus on specific advantages for fusion energy and limit the discussion primarily to metal AM. We note the substantial commercial efforts for just-in-time manufacturing to ensure products that are predictably within tolerance, using inverse solutions, uncertainty quantification, and dynamic process control. Capitalizing on these commercial trends will become timely when fusion moves toward high-volume products.

Metal additive manufacturing can be done via many methods, although the most popular involve powder bed methods. The two most common examples of this are selective laser melting (SLM) and electron beam melting (EBM). In both cases, a thin layer of metal powder is first spread over a substrate and is then locally (point by point) melted by an energy source, either a laser or electron beam for each method, respectively. The melted material forms a melt pool similar to welding, then rapidly cools to form solid metal structure. After an entire 2D layer is complete, a new layer of powder is spread over the top and the next layer is created by the same process. Upon completion, the component is removed from the unmelted powder and cleaned. Subsequent thermal processes, such as hot isostatic pressing, are often utilized to remove any residual porosity or alter the metallic microstructure. However, these post-processes are increasingly being avoided or are not needed. Other relevant metal AM techniques include laser-directed energy deposition, which does not require a powder bed but rather ejects powder out of a nozzle that is coincident with the laser, and electron beam wire AM, which uses a wire based feedstock and an electron beam to melt the material. Some of these other techniques also offer promise for in-situ repair of fusion reactor components.

AM is a rapidly accelerating field which can be leveraged by the fusion energy community for both improvements and discovery of (new) plasma-facing materials. A fundamental new concept associated with AM of metals is for the material, and consequently its

microstructure, to be formed at the same time the part is being created; aspects of material synthesis and manufacturing are thus now occurring simultaneously. This is both an opportunity and potential drawback. The opportunity is that there may be an ability to locally tailor the microstructure within a single component through manufacturing process parameters. While this capability is still emerging, the design of microstructure by varying energy source (laser or e-beam) power and speed to control heating and cooling rates in the melt pool (typically these are $>10^4$ °C per second) has been demonstrated. The drawback of this potential capability is that it may result in a more difficult qualification and certification process. Whereas material qualification and part certification previously were two separate processes, they have now been conflated. However, the potential benefit to fusion reactors is clear. The ability to create locally tailored materials would have multiple applications in fusion energy.

A second advantage of metal AM for fusion energy systems is the ability to create complex structures never before possible with conventional methods. This fundamentally changes how we would design important components such as divertors and heat exchangers. Complex lattice, or composite structures for lightweight-yet-strong components such as that shown in Figure 4.3.1 become plausible, as do triply periodic minimal surfaces like gyroids that may be ideal for heat exchangers. This new-found ability to create complexity radically opens the design space in ways that we may not even be able to conceive at this time.



Figure 4.3.1. Rhombic dodecahedral lattice structure made of 316SS using SLM. Photo courtesy of LLNL.

Advanced manufacturing and AM both transcend all sub-elements in the transformative enabling capability of Advanced Materials. Therefore, reference to advanced manufacturing and AM will occur throughout the remainder of this TEC chapter

4.3.1 Additive Manufacturing

Materials-by-design (MBD) is an emerging paradigm that combines a reductionist and synthetic approach envisioning a multi-scale level of control in structure and composition during manufacturing enabling tailored design of multi-functional materials. MBD combines predictive computational tools such as machine-learning algorithms with robust advanced manufacturing and synthesis approaches such as AM. An added advantage of AM and other emerging manufacturing approaches is the opportunity to leverage a robust external community with which to partner. However, *adopting and adapting* this technology to fusion-relevant materials strategies must be carefully evaluated. Advanced manufacturing will continue to see massive investment but it will not be specifically targeted at the fusion community's needs. As a result, some fusion specific research in partnership with existing manufacturing experts may go a long way towards establishing a credible translational development activity that will support development for advanced materials design and manufacturing of future fusion energy reactor-relevant materials.

Promise and development requirements: There are several promising advantages by combining materials-by-design with advanced manufacturing and AM approaches. These include: design of components of massively increased complexity and geometric design space, the ability to work with relevant materials such as refractory metals, and the potential for local control of microstructure at large scale. This characteristic could be a game-changer for future advanced fusion PFCs in that as a complex, hierarchical geometry is fabricated, the desired microstructure and ultimately desired properties, such as self-healing and tolerance to radiation damage, can be tailored during the manufacturing process. Another possibility is *in-situ* repair in a fusion energy reactor of damaged PFC components. New plasma facing materials may include tungsten (W)-based composites using oxidation resistant alloys such as W-Cr-Y, composite microstructures and cooling channels for helium gas, nanostructured tungsten, and high-entropy alloys such as WTaCrV. MEMS sensors and devices have been proposed for real-time data gathering⁴⁻⁷. The ability to emulate the real magnetic fusion/burning plasma environment in terms of heat fluxes, particle fluxes, tritium fluxes, and neutron fluxes will be critical in execution of MBD principles^{10, 11}. New materials and structures made through AM processes need to be integrated with computation, in situ measurements in relevant environments¹². We note that exotic materials developed for the fusion environment may have applications in the medical and space-technology fields.

Level of maturity: The extent of MBD approaches are intrinsically dependent on advances in advanced manufacturing and AM. AM methods are mature in creating new material compounds and structures. However, the TRL is lower (3 or less) with respect to magnetic fusion-relevant materials and components. Moreover, an understanding of AM process-structure-property relationships for metals and fusion-relevant materials is in its infancy.

Risks and uncertainties: An integrated approach that combines computer simulations, in-situ material characterization tools, and experimental validation, with AM tools is lacking, and this limits the ability to leverage MBD with efficacy and reliability. The material samples or sensors for in-situ data collection are either too small (coupon scale), too thin (thin film scale), or non-existent (smart sensors). The goals of MBD for magnetic fusion are to overcome current limitations in material performance and identify new or improved materials with (1) surface and structural robustness, and longevity ($>10^7$ s) to heat and particle loading in the main chamber; (2) erosion and degradation resistance in the divertor region to heat exhaust, low core contamination, compatible with magnetic geometry; (3) capabilities for tritium breeding; (4) neutron irradiation hardness. Usually several functions need to be obtained simultaneously for a single material compound and structure¹³⁻¹⁸. Computer simulations for predictive material discovery are extremely challenging because high-fidelity models span more than 20 orders of magnitude in time scale and over 8 orders of magnitude in length scale^{19, 20}. Although off-line material characterization tools are available and widely used, in-situ material characterization tools are less common²¹⁻²³. Experimental validations of new materials usually take a long time because of the limited access to burning plasma environments. A platform and specified standards to rapidly scan and validate new materials do not exist in major domestic or international magnetic fusion facilities^{24, 25}. The formation of such platforms and standards with a materials-by-design approach can be a strategic U.S. leadership position.

Time horizon: MBD combines computer simulations, material characterization tools, and experimental validation to accelerate the predictive discovery and synthesis of new materials. DoE Office of Science currently supports the seven-institution center for next generation of materials by design. The mission of the center is to accelerate the discovery of functional energy materials. The Vehicle Technologies Office also supports materials-by-design research to accelerate the discoveries or improvements in materials for transportation. According to the Materials Genome Initiative, it traditionally takes more than 20 years to develop and implement a new or improved material for automotive applications. The methods of materials-by-design have yet to be applied to material challenges in magnetic fusion. Experiences from other fields provide tantalizing new material discovery possibilities for magnetic fusion.

Global strengths and gaps: The U.S. plays a leading role in MBD approaches and has supported the Materials Genome Initiative through the National Science Foundation and several Energy Frontier Research Centers focused on MBD paradigms. Similarly, the U.S. is a world-leader in the development of additive manufacturing techniques along with Germany and Japan²⁶, specifically related to 3D printing. However, this is mostly in the printing of polymer-based materials and metallic alloys and there is a technology gap for refractory metallic alloys. Both Germany and the U.S. are leading the effort in metal-based AM technology in various industries including automotive and aerospace. Although this translation focuses on complex components for these industries, the U.S. has the potential of leadership in AM development of refractory alloys for nuclear fusion applications.

4.3.2 Emergent Nuclear Fusion Materials

Emergent nuclear fusion materials include: *adaptive and self-healing materials, complex hierarchical composites, complex alloys, and hybrid liquid/solid systems*. One of the greatest challenges to the plasma-material interface for future fusion energy reactor environments is the performance of the plasma-facing components (PFCs) inside the vessel. The combination of high-heat flux and particle flux exposure, along with possible transient events in the fusion reactor, result in extreme conditions limiting the lifetime and performance of both PFCs and structural materials. In many modern technologies, materials are the limiting factor when it comes to strength, durability, resistance to thermal load, the influence of aggressive chemical processes or radiation fluxes. In the context of PMI and fusion materials, breakthroughs are limited due to the extreme operational regime demands *and* lack of a robust materials-development program for fusion energy. This sub-element on *emergent fusion materials* shows one of the most promising collections of transformational enabling technologies for future fusion energy reactors.

Level of maturity: Development of radiation-tolerant and radiation-resistant structural materials remain¹ at TRL ~ 1-2. Development has been limited to numerous factors including: materials availability, unknown materials design variables such as processing, performance and function in the expected extreme regimes of a fusion energy reactor. These issues are currently the focus of basic and applied research, but largely guided by TRL level 1-2-based research. There is a *critical need* to support translational research, i.e. advancing the TRL, in parallel with current basic/applied university research to begin aggressive development of *scalable advanced manufacturing technologies* of candidate-emergent nuclear fusion materials discovered in the laboratory. Currently, no systematic

translational work has addressed the collection of complex processes at the surface in the engineering design of a practical and multi-functional PFC that uses refractory metals with advanced low-Z/refractory nano-composite as a basis. The lack of an external industry driver for nuclear fusion reactor-relevant materials is one handicap to progress, although limited advances have been achieved through the SBIR/STTR DOE programs where a number of advanced materials PFC technologies have been developed to close this technology gap. Some of these efforts include functionally graded hierarchical tungsten-based materials, tungsten foam materials, and complex porous refractory alloys (e.g. TZM based materials) among others. Functionally graded structure minimizes thermal mismatch stress, including fatigue, and can increase rupture life by three orders of magnitude¹.

External drivers to fusion technology exist in areas in which structural materials design meets performance criteria in extreme environments such as aerospace structures. The pioneering work of White, Moore, Sottos²⁷, and van der Zwaag, coworkers²⁸ in so-called self-healing or autonomous materials, is one exciting example where progress has been made. In other examples, “adaptive” radiation-resistant materials are being developed. Adaptive materials consist of a hierarchical structural material system that intrinsically adapts to its extreme environment by responding to external stimuli, such as the high-heat and particle fluxes from fusion plasma. — thus providing both self-healing of the matrix and also adapting the material interface to the evolving plasma. Although self-healing materials have been demonstrated at TRL of 3-4 in some aerospace structures and materials protection applications, most remain focused on polymer-based systems. For self-healing metallic-based materials and adaptive materials, development remains at TRL of 1-2 and non-existent for refractory metals.

UHTC (ultra-high-temperature composites), MAX phases, and HEAs (high-entropy alloys) are among the emerging high-temperature materials that may be attractive for fusion thermo-structural components. These types of materials are typically immature, with TRL ~ 1-3. More mature TRL exists for more nuclear-centric emergent materials such as SiC-SiC complex composites and castable nanostructured alloys²⁸. Either choice of these materials requires a substantial investment in both research and development — particularly translational research that can adapt these technologies to nuclear fusion reactor-relevant performance metrics of high-temperature, radiation damage exposure and high-duty cycle operation.

Promise and development requirements: Complex composites and complex alloys in the solid phase may have promising developments that could impact plasma-facing components for fusion energy reactor applications. The promise of such complex materials systems to provide for a radiation “tolerant” or even a radiation “resistant” materials platform in the solid phase could be a game-changer. This promise must be balanced with the fact that currently solid-state materials meet only limited requirements of pre-reactor PFC conditions in a plasma-burning environment such as ITER. A number of developments are currently underway that involve the use of refractory-based materials and SiC-based systems. The use of complex composite geometries is believed to be essential for refractory-based materials intended for fusion energy applications, due to the lack of toughness at lower operational temperatures. One example is ductile phase-toughened tungsten composites. Another promising development is that of dispersion-strengthened tungsten alloys. Kurishita et al. have been global leaders in the R&D of dispersion-

strengthened alloy systems, although the United States and China have recently joined in early-stage development of fusion-relevant materials systems¹.

Continuous fiber composites (W/W, SiC/SiC), laminate composites (RAFMS/W) and non-W composites all have promising thermal fatigue and thermo-mechanical response properties in current laboratory experiments. Developments in SiC/SiC composites have benefited the fusion materials community due to technology “pull” from the ceramic gas turbine industry and adoption to nuclear-grade development. However, there are many development requirements, in particular materials testing under fusion reactor-relevant conditions e.g. high-dpa, neutron-relevant energy distribution, high-temperature, and high-duty cycle.

Liquid metals present intrinsic advantages over solid PFCs for nuclear fusion reactor-relevant applications in several areas. Liquid metals provide a self-healing/renewable plasma-facing interface that may adapt to conditions in a fusion energy reactor. Hybrid systems combine a solid-state mesh or matrix to support liquid-metal wetting and filling of the plasma-facing surface to protect substrate refractory metal materials from the plasma. Actively supplied capillary-restrained systems, porous surface geometry, textured substrates²⁹ are among promising systems. Limiting liquid-metal to confined material structures where the liquid-metal phase is maintained in a scale of the order of a few fractions of a mm to microns in a complex metallic matrix (e.g. refractory metal foams) may provide a material system that can both self-heal in the liquid phase and maintain the solid-phase structural properties that can withstand large heat flux. However, the technology development of liquid metal hybrid systems remain elusive due to significant technology gaps including: safety, tritium handling, temperature control, materials instabilities and unknown reliability in operation, combined with limited development efforts. Technology development in these hybrid liquid/solid systems remains nascent at TRL of 1-3, with some prototype systems already deployed in tokamaks around the world such as T-11 M in Russia, FTU in Frascati, EAST in China, and the Lithium Tokamak Experiment at PPPL³⁰.

Risks and uncertainties: There are many risks and uncertainties associated with the early-stage materials development of complex composites and alloys described above. These include: radiation effects that can drive materials into metastable phases, chemical incompatibilities, unknown PMI properties, poorly characterized tritium retention, and potential embrittlement, any of which could hinder performance under high-duty fusion burning-plasma environments¹. Time horizons are speculated near 10-15 years depending on investment levels that drive development for fusion energy-relevant conditions. External technology pull with some advanced materials technologies, such as high-temperature ceramics and complex composites in industries outside of fusion, could reduce the risk of development. However, a number of technologies described still face significant risk given the lack of external technology development outside fusion. This is particularly relevant for self-healing metallic-based materials, complex alloys and adaptive PFC materials that must be designed to be compatible with hydrogen-based plasma-burning fusion conditions. Hybrid systems that combine solid-phase and liquid-phase materials and composites have the highest risk given unknown scale-up development and unknown safety and performance margins. Sn and Li mixing and unknown wetting properties on complex surface geometries, trapping of eroded metal (especially Sn) and unknown hydrogenic

retention properties with unknown long-term corrosion issues form part of the large uncertainty and high risk with these technologies.

Time horizon: The time horizon for development of emergent fusion materials is dependent on both internal and external factors. Internal factors consist of investment of materials development for conditions relevant to nuclear fusion reactors used in high-duty cycle conditions. Time horizons for full development of advanced materials for fusion energy development span two-to-three decades. However, external drivers that the fusion materials community can leverage can accelerate development and result in fusion materials development time horizons between 10-15 years for advanced materials technologies that include SiC/SiC composites, CNAs, high-temperature ceramics and conventional liquid/solid systems. Self-healing metallic-based systems, advanced hybrid systems, adaptive PFCs and more complex alloys and W-based complex alloys and composites will have time horizons of 15-25 years. **Global strengths and gaps:** The U.S. is a leader in the development of several world-leading high-temperature nuclear fusion materials. Castable nanostructured alloys (CNAs) in fusion, SiC/SiC composites and liquid metal-based hybrid technologies are among some of the most salient examples of U.S. leadership. In particular, the U.S. has been a leader in the design of advanced liquid-based PFC basic- and applied-science investigation for fusion and could continue to provide this leadership.

4.3.3 Divertor Materials

The material requirements for divertors are sometimes compared with those for rocket engines⁴⁶. Rocket engines however, only run continuously for minutes. In comparison, divertors in a fusion power plant need to operate for a significant fraction of a year. The importance and requirements of divertor materials are well documented, and they may be summarized briefly as: (1) Compatible with the steady-state heat load up to 10 MW/m² in the divertor region, and with higher heat flux densities in cases of transient events such as ELMs and disruptions; (2) Compatible with other magnetic fusion operations or hardware such as fueling, cooling, heating, and magnetic field configuration; (3) Compatible with a high-performance plasma core by minimizing the impurity flux and other effects⁴⁷⁻⁵⁰. Thus, there are unique aspects of divertor material selection for future devices, with leading candidates of tungsten/composites, certain ceramics, and liquids.

Promise and development requirements: While tungsten was chosen for the ITER divertor, the lack of a viable method to improve the ductility of the bulk form of tungsten likely mandates the use of W in composite forms. Examples of tungsten-based refractory composites include continuous fiber W-matrix composites, distributed or semi-interconnected W particulate composites and others. Beside W composites, W foam core and other refractory metal shell/core were also proposed when used in conjunction with flowing helium cooling; preliminary results indicate 22 MW/m² and above heat handling capability. Other solid PFC material candidates include ultra-high-temperature ceramics such as borides (ZrB₂) and carbides, refractory high entropy alloys such as V-Nb-Mo-Ta-W, Fe-Ni-Mn-Cr and Ni-Co-Fe-Cr systems, and castable nanostructured alloys such as ferritic/martensitic steels and MAX-phase ceramic matrix composites such as Ti₃SiC₂³⁹⁻⁴⁵.

Testing facilities for divertor materials will be valuable in assessing their suitability (e.g. see Chapter 6.8). The material discoveries and qualification will need to be integrated with advanced computation, e.g. exascale computing. This will likely reduce the cycles for testing and prototype development. The material effort also needs to be integrated with new divertor concepts³¹⁻³⁶, to evaluate boundary plasma solutions for fusion experiments beyond ITER³⁷. While there are also fusion-specific requirements such as 14 MeV DT neutron activation and radiation hardness, material testing and characterization in a fission reactor could provide valuable data about basic irradiation performance³⁸.

Level of maturity: Most of these materials and structures are still in the laboratory testing and validation phase (or TRL 3-4), although some may soon find some industrial applications that will elevate the level of maturity³⁹⁻⁴⁵. With respect to magnetic fusion applications, the TRL is usually lower. In the case of composites such as HEAs, only very limited systems have so far been explored among a large number of possible candidates.

Risks and uncertainties: Additional fusion-specific performance risk factors include neutron irradiation tolerance, plasma-interactive performances, and tritium retention. Time and cost required for the nuclear performances evaluations depend largely on the activation properties of the material. W is relatively challenging due to high short-term radioactivity that typically requires cooling time of a few years following neutron irradiation.

Time horizon: this was not evaluated by the panel.

Global strengths and gaps: this was not evaluated by the panel.

4.3.4 Complex Component Design

The use of advanced manufacturing techniques will open up the possibility of revolutionary designs for a range of applications. Unique topologies can be created for heat transfer systems for a variety of fluid media, e.g. helium, water, liquid metals, balancing the needs for high thermal transfer and minimal pressure drop^{41,64,65}. Three-dimensional vacuum chambers, such as required for optimized stellarator configurations, will benefit from fabrication techniques that are not restricted by geometric complexity. Novel designs will be possible for plasma heating systems and components (e.g. antennas and coils), as well as for diagnostic systems.⁶⁶

In regard to the design of complex heat transfer systems, all three mechanisms for heat transfer are present in a burning plasma environment: thermal conduction in solids; convection by liquids, gases and plasmas; and radiation in all parts of the electromagnetic spectrum. Radiation by 14.1 MeV D-T neutrons is also important in fusion reactors since about 80% of the fusion energy is carried by the neutrons. Neutron transport is unaffected by the multi-tesla magnetic fields used for plasma confinement and exhaust control. Although heat-transfer systems near the first wall and divertor are emphasized among the whitepapers submitted, radiative cooling by visible light and other electromagnetic radiation can be quite beneficial in mitigating heat-transfer challenges in magnetic fusion.

Promise and development requirements: Since the anticipated transient and steady-state heat fluxes exceed solid material limits in fusion, cooling technologies are needed for plasma facing components such as the first wall, divertor, other in-vessel components such as blankets; heat exchange is also needed for efficient power conversion. Heat transfer systems need not only to carry away the heat at sufficiently high rates, but also to (1) function in strong magnetic fields; (2) maintain surface and structural robustness, and longevity ($>10^7$ s) to continuous heat in the main chamber; (3) resist erosions in the divertor region and introduce low if any plasma core contamination; (4) be compatible with tritium breeding and blanket functions in the main chamber; (5) withstand neutron flux for extended periods of time and not produce excessive amount of radioactive material due to neutron activation. Usually several if not all functions need to be achieved together for a single material compound and structure.

A large portion of the whitepapers address solid cooling structures through additive or advanced manufacturing⁵¹⁻⁵⁷. The growing number of AM technologies, which include 3D printing, selective laser melting, electron beam melting, chemical vapor infiltration/deposition, spark plasma sintering, field-assisted sintering, etc., can be if not already used for advanced cooling systems. Compared with traditional “reductive fabrication” approaches, AM can produce structures with sub-mm (potentially down to nanometer) precision in meter-size and larger scales, along with graded material composition and density, and sophisticated geometries that may be inaccessible to subtractive manufacturing. AM processes can be fully automated, are less wasteful in terms of material and energy use, and can be less expensive. Alternatively, liquid metal-based structures and nanofluidics⁵⁸⁻⁶⁰, which can continuously refresh themselves, can also function as cooling systems and be used for plasma conditioning, neutron absorption, and tritium breeding. AM methods can also be used to fabricate surfaces and supply structures for liquid-metal systems.

Field tests of the new cooling structures will be needed to elevate the TRL levels of the proposed cooling systems. Access to relevant heat fluxes, particle fluxes, tritium fluxes, and neutron fluxes will be critical to further development of various cooling systems and components⁶¹. New materials and structures made through AM processes need to be integrated with computation, in-situ measurements in relevant environment⁶²⁻⁶³.

Level of maturity: Commercial AM tools and methods are available and used for creating new material compounds and structures down to micrometers. Novel forms of materials such as tungsten foams, graphitic foams, hollow interconnected ligament structures, etc. have been demonstrated (TRL 5 or higher)⁵¹⁻⁵⁷. However, TRL is lower (3 or less) with respect to magnetic fusion-specific applications.

Risks and uncertainties: Few if any experimental demonstrations of fusion relevant cooling systems exist in relevant plasma, neutron and fusion environment. Also, in many cases, design methods have not caught up with the increased design space afforded by new manufacturing tools. For example, heat exchanger designs are still largely restricted to forward modeling solutions and perceived manufacturing constraints. Due to the new ability to fabricate highly complex structures with AM, inverse design techniques such as topology optimization should be explored to achieve mathematically optimal designs.

Time horizon: this was not evaluated by the panel.

Global strengths and gaps: this was not evaluated by the panel.

Summary

The sub-elements discussed in this chapter form the basis for one of the most promising transformational enabling technologies in advanced materials for fusion energy. Advances in complex materials design integrates: processing, structure, properties, performance and characterization. The promise of these transformational enabling technologies is closely connected to technology developments both inside and outside fusion engineering. More importantly, some technology advances are being “pulled” by external drivers toward fusion energy. These advances include additive manufacturing, materials-by-design and self-healing materials, among others. These drivers are supported by multi-billion dollar industries including: semiconductor processing, aerospace, automotive, and other sectors that in themselves must address translational development challenges that include safety, performance in extreme conditions, component lifetime and economies of scale. With increasing innovation breakthroughs being shifted to innovation ecosystems both inside and outside industrial sectors, development of advanced materials in fusion energy must continually look to leveraging opportunities wherever possible. Such opportunities include additive manufacturing approaches for design of complex heat-transfer systems for fusion reactors, and complex mesoscale radiation resistant materials for the PMI.

References

1. Y. Katoh, “Emerging High Temperature Materials for Potential Application to Fusion,” TEC whitepaper (2017).
2. R. Dehoff, “Advanced Manufacturing – A Transformative Enabling Capability for Advancing Fusion,” TEC whitepaper (2017).
3. GE Additive, Press Release, November 15, 2016, Boston, MA.
4. J.W. Coenen *et al.*, *Fus. Eng. Des.* **124** (2016) 964.
5. A. Calvo *et al.*, *Phys. Scripta* **T167** (2016), 014041.
6. P. Lopez-Ruiz *et al.*, *J. Nucl. Mater.* **442** (2013) S219.
7. S.J. Zinkle, *Phys. Scripta* **T167** (2016) 014004.
8. A. Litnovsky *et al.*, *Nucl. Fusion* **57** (2017) 066020.
9. J. Drobny *et al.*, *J. Nucl. Mater.* **494** (2017) 278.
10. W. Eckstein, Computer simulation of ion-solid interactions, volume 10, Springer Series in Materials Science, 1991.
11. Ch. Linsmeier *et al.*, *Nucl. Fusion* **57** (2017) 092012.
12. J.L. Barton *et al.*, *Nucl. Fusion* **56** (2016) 106030.
13. J. Sedlak *et al.*, *Acta Polytechnica* **55** (2015) 260.
14. E.E. Bloom *et al.*, *J. Nucl. Mater.* **329-333** (2004) 12.
15. S.A. Maloy *et al.*, *J. Nucl. Mater.* **293** (2001) 119.
16. G. Federici *et al.*, *Nucl. Fusion* **57** (2017) 092002.
17. Y. Ueda *et al.* *Nucl. Fusion* **57** (2017) 092006.
18. S.J. Zinkle, *Phys. Plasmas* **12** (2005) 058001
19. P. Promopatum *et al.*, *J. Mater. Process. Technol.* **240** (2017) 262.
20. D.P. Stotler *et al.*, *Nucl. Fusion* **57** (2017) 086028.

21. Y. Zou, *et al.*, *Nat. Commun.* **6** (2015) 7748.
22. T. Koyanagi *et al.*, *J. Nucl. Mater.* **490** (2017) 66.
23. G.M. McCracken and P. E. Stott, *Nucl. Fusion* **19** (1979) 889.
24. Ch. Linsmeier *et al.*, *Nucl. Fusion* **57** (2017) 092012.
25. J.L. Barton *et al.*, *Nucl. Fusion* **56** (2016) 106030.
26. World Intellectual Property Report, *Breakthrough Innovation and Economic Growth*, WIPO, 2015
27. S.R. White *et al.*, *Nature* **409** (2001) 794.
28. I.S. van der Zwaag *et al.*, *An Alternative Approach to 20 Centuries of Materials Science*, Springer Series in materials science, Volumes 40–87.
29. D.N. Ruzic *et al.*, *Nucl. Fusion* **51** (2011) 102002.
30. S.V. Mirnov *et al.*, *J. Nucl. Mater.* **390-391** (2009) 876
31. H.Y. Guo. *et al.*, *Nucl. Fusion* **57** (2017) 044001.
32. X.R. Wanget *al.*, *Fus. Sci. Tech.* **56** (2009) 1023.
33. P. Norajitra *et al.*, *Fus. Eng. Des.* **86** (2011) 1656.
34. S.V. Mirnov, *J. Nucl. Mater.* **196-198** (1992) 45.
35. R. Majeski, *et al.*, *Phys. Plasmas* **24** (2017) 056110.
36. V.A. Evtikhin, *Plasma Phys. Control. Fusion* **44** (2002) 955.
37. A.M. Garofalo *et al.*, *Fusion Eng. Des.* **89** (2014) 876.
38. C. English and D. Buckthorpe, *Nucl. Fusion* **57** (2017) 092010.
39. E.W. Neuman *et al.*, *J. Am. Ceram. Soc.* **99** (2016) 597.
40. J.W. Yeh, *JOM* **65** (2013) 1759.
41. Y. Katoh, “Advanced Manufacturing for Fusion PFC and Blanket Materials,” TEC whitepaper (2017).
42. M.W. Barsoum and T. El-Raghy, *Am. Sci.* **89** (2001) 334.
43. M. Radovic, *et al.*, *Scan. Electron Microsc.* **48** (2000) 453.
44. L. Tan, L.L. Snead, and Y. Katoh, *J. Nucl. Mater.* **478** (2016) 42.
45. N.A.P.K. Kumar *et al.*, *Acta Mater.* **113** (2016) 230.
46. D. Sekulic, D., *Advances in Brazing: Science, Technology and Applications*, Woodhead Publication (2013).
47. P.C. Stangeby and A. W. Leonard, *Nucl. Fusion* **51** (2011) 063001.
48. V.S. Chan *et al.*, *Nucl. Fusion* **55** (2015) 023017.
49. M.N. Rosenbluth (ed.), *New Ideas in Tokamak Confinement*, AIP (1994).
50. W.J. Nuttal, *Fusion as an energy source, challenges and opportunities*, AIP (2008),
51. A. Rape *et al.*, *J. Mater. Sci.* **46** (2011) 94.
52. D.L. Youchison, *Fus. Sci. Technol.* **68** (2015) 587.
53. Z.A. Munir, U. Anselmi-Tamburini, and M. Ohyanagi, *J. Mater. Sci.* **41** (2006) 763.
54. D.M. Keicher *et al.*, *SPIE* **91** (1997) 2993.
55. S.M. Gaytan *et al.*, *Mat. Tech.: Advanced Performance Mat.* **24** (2009) 180.
56. Z.A. Munir, U. Anselmi-Tamburini, and M. Ohyanagi, *J. Mater. Sci.* **41** (2006) 763.
57. T. Ihli, *et al.*, *Fus. Eng. Des.* **82** (2007), 249.
58. S.I. Krasheninnikov, L. E. Zakharov, and G. V. Pereverzev, *Phys. Plasmas* **10** (2003) 1678.
59. R.J. Goldston, R. Myers, and J. Schwartz, *Phys. Scripta* **T167** (2016) 014017.
60. R. Azizian *et al.*, *International J. Heat Mass Transfer* **68** (2014) 94-109
61. Linsmeier, Ch. *et al.*, *Nucl. Fusion* **57** (2017) 092012.
62. P.A. Psaras and H. D. Langford (eds.), *Advancing Materials Research*, (1987).

63. “Priorities, Gaps and Opportunities: Towards A Long-Range Strategic Plan for Magnetic Fusion Energy,” Fusion Energy Sciences Advisory Committee (FESAC) Greenwald Panel Report, October 2007
http://science.energy.gov/~media/fes/fesac/pdf/2007/Fesac_planning_report.pdf
64. D.L. Youchison, “Advanced cooling technologies through additive manufacturing,” TEC whitepaper (2017).
65. B. Williams, “Ultrahigh heat flux helium-cooled divertor incorporating a foam core heat exchanger,” TEC whitepaper (2017).
66. C. Romero-Talamas, “Additive manufacturing of plasma diagnostics,” TEC whitepaper (2017).

IV.IV TRANSFORMATIVE ENABLING CAPABILITY NOVEL TECHNOLOGIES FOR TRITIUM FUEL CYCLE CONTROL

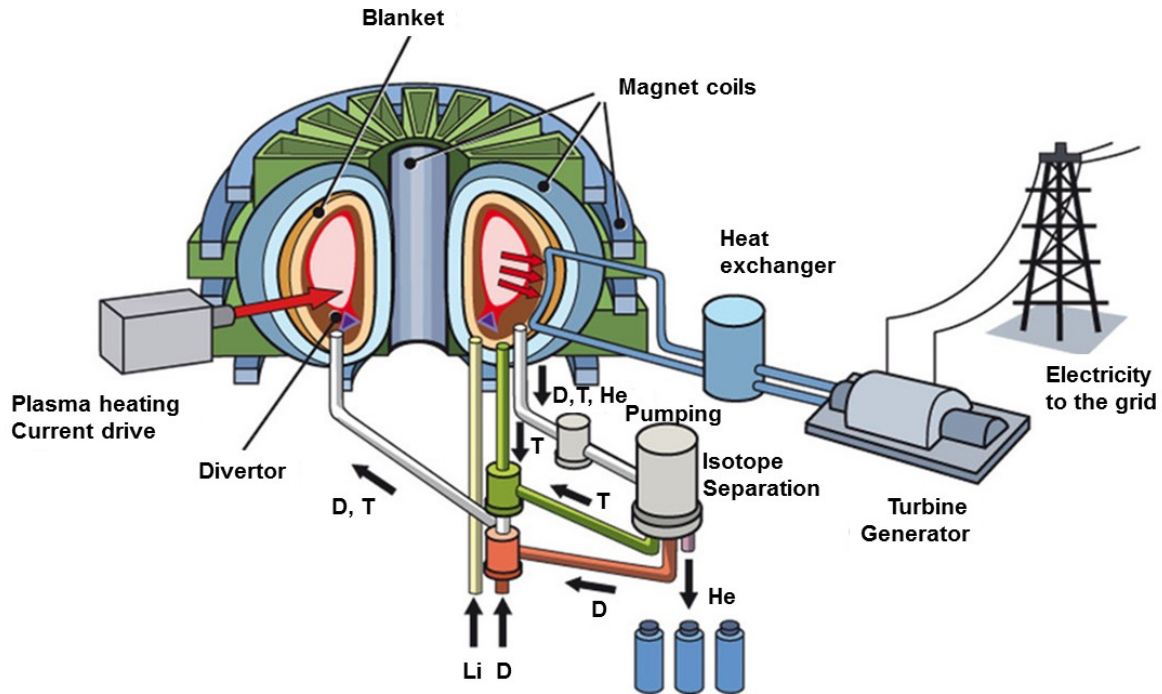

Layout of a future tokamak fusion power plant © IPP,
<http://www.ipp.mpg.de/14755/aufbau>

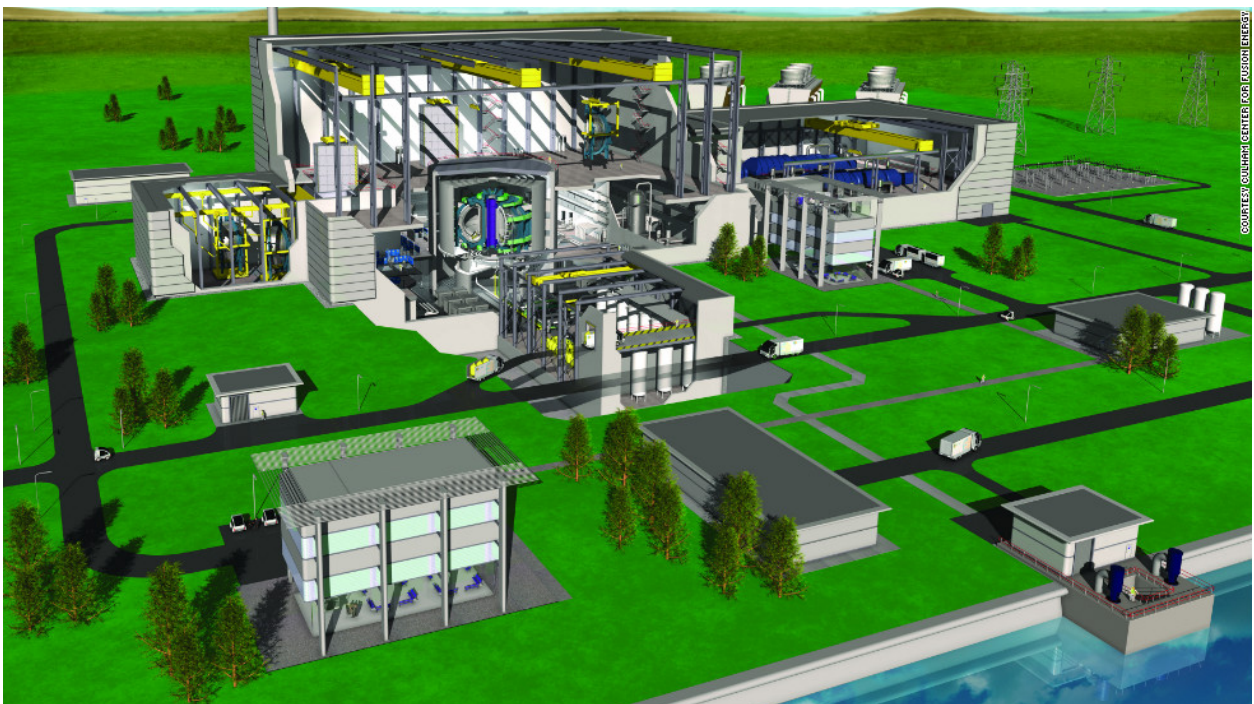

Conception of fusion power plant (© EUROfusion): <https://www.iter.org/sci/Fusion>

4.4 Novel Technologies for Tritium Fuel Cycle Control

Overview

Future fusion reactor power plants will consume unprecedented quantities of tritium, approximately 100-150 kilograms every year for a typical gigawatt-scale electrical power plant². This tritium must be produced by the reactor plant itself through neutron-lithium nuclear transmutation reactions in a *breeding blanket* surrounding the thermonuclear fusing plasma. The blanket assembly is also the main heat transfer system and must operate at very high temperatures (near 700 °C) to maximize power conversion efficiency and ensure a competitive cost of electricity. The extraction and processing systems for this rate of tritium production will exceed those required by ITER by more than a factor of four³. The large production rate and associated storage inventory, coupled with the rapid mobility of tritium through most structural materials at these temperatures, will require technological capabilities well beyond those planned for ITER to guarantee plant safety, reliability, and low environmental impact. The production, extraction and processing of tritium constitutes a grand challenge for all currently-envisioned nuclear fusion-powered electrical plants⁴. Technologies that address these specific challenges and show favorable potential for transforming the vision and promise of fusion power include:

- *Tritium fuel production*: Of the blanket technologies presented, two stood out as enabling significantly higher thermal to electrical efficiency (η_{th}) and tritium breeding ratio (TBR). The *dual-coolant lead lithium (DCLL) blanket* was identified as having the potential for producing one of the highest η_{th} ($\geq 45\%$) and TBR of any blanket concept to date. The TBR in this concept can also be adjusted dynamically during operations to optimize use and storage. *Cellular-Ceramics*, for solid breeding media applications, also hold promise for significantly higher TBR and working-fluid temperature through high precision control of porosity, composition, and other design elements. Successful development of this technology would also address unresolved ceramic pebble bed blanket sintering problems.
- *Tritium fuel extraction*: Liquid metal (LM) breeding blankets have the greatest potential for producing high-efficiency fusion power reactors. To achieve this goal, these reactors need tritium extraction technologies that can process the entire LM flow at high temperatures and with high extraction efficiencies ($> 80\%$) in order to maximize plant performance and safety. LM tritium extraction technologies presented to the panel that meet these criteria fell into two types: *electrolytic membrane extraction* and *permeable membrane extraction* methods.
- *Tritium fuel processing*: A driver for a reactor's fueling plant tritium inventory and processing flowrate is the plasma's tritium burn fraction (TBF). A key technology presented to the panel that has the potential for simultaneously decoupling plasma and tritium plant operation, reducing the size and inventory of the tritium plant by 75%, reducing the demand on a reactor cryoplant and providing steady state vacuum vessel pumping operation is the "*superpermeable*" *metal foil pump (MFP)*.

Development of these technologies is driven exclusively by fusion applications, so the transformation will have to come from the fusion community. The necessary eventual

involvement from industry is a challenge due to the lack of demand for non-fusion uses and the long time before the fusion applications will require industrial-scale production. For the other TECs, developments can result in advancements for near-term facilities, while these fuel cycle technologies will only demonstrate their effectiveness in a power plant. However, the technologies presented here not only provide a necessary function for such a power plant, but have the potential to increase the efficiency, improve the safety, and reduce the regulatory burden, which could bring a power plant to reality more quickly.

4.4.1 Fusion Reactor Blanket Technologies for Heat Removal and Tritium Breeding

Overview of Fusion Reactor Blankets

Fusion power reactors fueled with deuterium and tritium (DT) produce energy primarily in the form of 3.5 MeV alpha particles and 14.1 MeV neutrons. The neutron energy escapes the plasma core and is converted to heat for transport to a thermal/electric energy conversion system (Heat Removal, also termed Power Extraction, see Sec. 6.7). Reactors also require a continuous supply of tritium in such large quantities that in-reactor tritium breeding is required, also using fusion neutrons. D-T reactor concepts at present combine these two functions of heat removal and tritium breeding into blankets that surround the plasma core. Breeding ratio is a critical fuel cycle parameter and maximizing it requires very close physical coupling between the plasma core and the breeding volume which leads to a third function for the blanket: a structural surface that directly faces the plasma. This "first wall," along with the rest of the blanket structure, must withstand the severe thermal and nuclear environment for a cost-effective duration of time. Breeding tritium requires a neutron-absorbing medium (solid or liquid) containing a high fraction of lithium which can produce tritium through nuclear reactions with both Li-6 and Li-7 isotopes. Blanket concepts include solid lithium-bearing breeding media with a flowing heat-removal gas or liquid, flowing lithium-bearing liquids that provide both a breeding media and heat-removal, or combinations with flowing liquid breeding + heat removal fluids with additional gas cooling. The primary challenge in blankets is to satisfy all the material compatibility, structural integrity, and lifetime requirements while still removing heat, breeding tritium and providing a first wall.

Previous input to FESAC such as the Zinkle Report⁵ detailed the challenges and state of the art in blanket technology. The main finding was that the ultimate attractiveness of a fusion system depends on the performance of power extraction and tritium breeding systems that surround the plasma, and that at present these systems are at a low technical readiness level with high uncertainty as to the performance of envisioned solutions and material systems. These challenges were reinforced in the 5 whitepapers^{2, 6-9} submitted to the Reactor and Balance of Plant (BOP) panel of this FESAC subcommittee. Two of the white papers^{2, 6} described the most advanced U.S. concepts: the Dual Coolant Lead Lithium (DCLL) concept and a gas-cooled solid ceramic system that exploits new methods of creating "cellular ceramics" with precisely-crafted porosity and other attractive properties. Because there are presently no blanket concepts that have been successfully demonstrated to meet the requirements of fusion power reactors, the technologies proposed to the panel were identified by the panel as top tier transformative technologies.

Dual-coolant Lead Lithium (DCLL)

The DCLL^{10, 11} uses flowing liquid PbLi as both breeder and coolant for the breeding zones, while utilizing high pressure helium to cool all structures including those

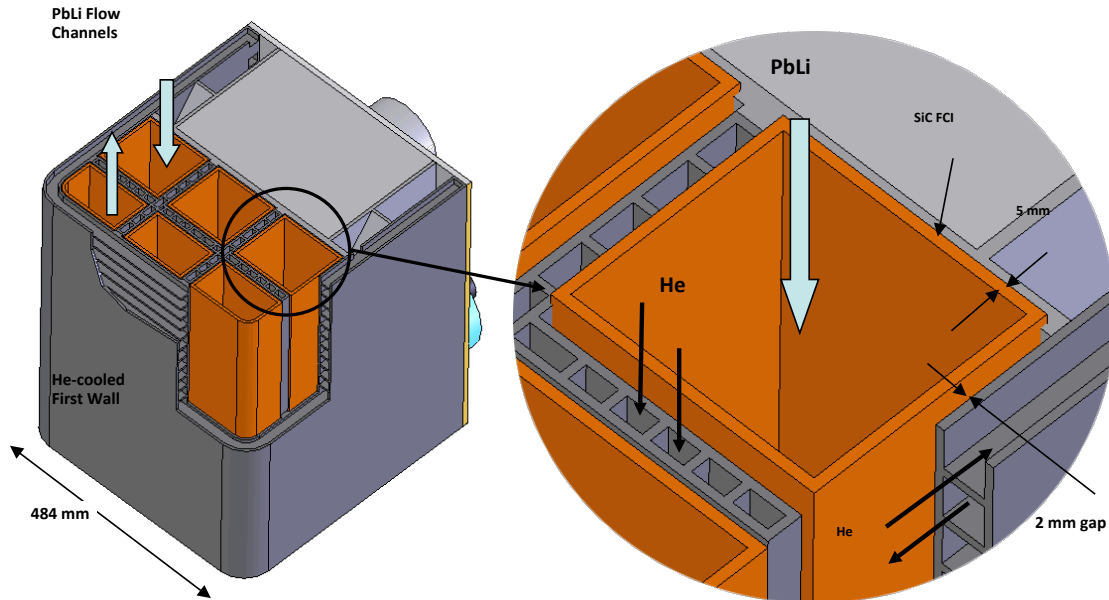

Figure 4.4.1: schematic representation of Dual Coolant Lead Lithium blanket

surrounding the breeding zone. Flow channel inserts made of a SiC-composite placed in all liquid metal ducts serve as electrical and thermal insulator, enabling a liquid metal exit temperature about 200K higher than the maximum temperature of the steel structure (Figure 4.4.1). With this configuration the thermal efficiency in the power conversion system can approach 45%, compared to values of ~40% for entirely He-cooled blankets.

Technology Assessment: DCLL

Level of maturity: DCLL is one of the widely studied liquid metal blanket concepts. PbLi is widely used in the design of other concepts, including those for ITER and many paper reactor designs based on high aspect ratio tokamaks, spherical tokamaks, and stellarators. However very little testing has been done.

Promise and development requirements: Several key feasibility issues for the lead-lithium based blanket concepts should be examined as soon as possible to establish confidence in successful development. Issues include tritium extraction from hot PbLi and He; liquid metal MHD effects on flow control and heat, tritium and mass transfer; chemistry control and compatibility of PbLi with, and thermomechanical loading of, ferritic steel structures and ceramic flow channel inserts. The development of coupled models and predictive capabilities that can simulate time-varying temperature, mass transport, and mechanical response of blanket components and systems should be emphasized. Predictive capabilities should be validated against the experimental database; used to explore the coupling

between disparate phenomena and loading conditions; and used to extrapolate beyond testing conditions to help guide and interpret further experimentation.

Time horizon: A practical timeline will require a fully integrated strategy that is yet to be established. Early-on activities should include a mix of single- and multi-effect experiments in non-nuclear environments. These activities can be followed by multi-material unit cells and mockups under combined loads where phenomena studied in separate effects tests can produce interactions that may lead to unanticipated synergistic effects. Multiple-effect test facilities will then be needed that combine thermal, mechanical, chemical, electromagnetic, and eventually nuclear conditions. Nuclear testing of components and assemblies will need to be aligned with the availability of high flux/high fluence neutron source test facilities.

Risks and uncertainties: Tritium breeding ratio (TBR) is sensitive to the details of the design and uncertainties in the inputs to the complicated computer simulations needed to evaluate performance. Material compatibility requirements will limit options. A high-fluence neutron source facility will be needed and there is uncertainty in when this capability could be made available.

Global strengths and gaps: PbLi is targeted for use in multiple international designs, which broadens the resource space for leveraging outside activities in liquid metal technology, such as material compatibility and corrosion. As matters currently stand, the U.S. will not have access to the ITER TBM data (the ITER TBM program is organized outside of the ITER agreement).

Cellular Solid Breeder Media

As described in one white paper⁶, an advanced lithium zirconate (Li_2ZrO_3) solid breeder material has been developed in the form of a cellular ceramic. The breeder is melt infiltrated into highly porous open-cell carbon foam, after which the carbon foam is removed by oxidation. The process leaves a nominally 90% dense breeder material by volume, with an internal network of interconnected micro-channels for enhanced tritium release, as shown in Figures 4.4.2. Thermal conductivity is substantially increased relative to pebble beds, high-temperature sintering is eliminated, and tritium breeding ratio (TBR) and breeder durability are increased. Replacing a pebble bed with a cellular breeder is anticipated to reduce blanket size and system cost, and increase TBR by as much as 20%, which is considered an enormous enhancement in tritium production. Preliminary

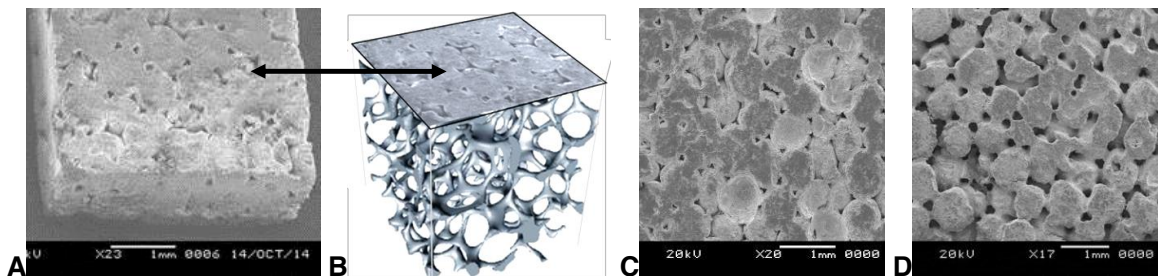

Figure 4.4.2A-D: SEM image of cellular breeder block (A), tomography scan showing network of interconnected internal micro-channels (B), and SEM images of 90% dense (C), and 78% dense (D) Li_2ZrO_3 cellular breeder fabricated using foam skeletons having different ligament diameters.

neutronics calculations indicate that for a given TBR, overall blanket thickness may be reduced by as much as 30- 40% compared with pebble bed configurations.

The breeder blanket concept being developed to exploit cellular solid ceramics is based on using cooling trays instead of cooling tubes, inspired by the EU's latest proposed helium-cooled pebble bed design¹². Features of this blanket design include breeder blocks with a thickness of 3 cm at 90% density by volume located above horizontal cooling trays. In comparison, pebble bed layers are typically 1 cm thick with ~60% density by volume. The multiplier material (beryllium pebbles) is also placed above the cooling trays, alternating with cellular breeder block layers.

Technology Assessment: Cellular Breeder Ceramic Media

Level of maturity: Ultramet's current project for DOE will conclude in July 2018 with fabrication and thermal testing of a blanket segment prototype, at which time the TRL will increase from the current 3 to 4 (for the cellular media, not the blanket module)

Promise and development requirements, and possible next steps: To bring the cellular media technology from TRL 4 to TRL 6, future work must include additional system optimization, properties testing, and irradiation testing. A comprehensive design database including mechanical properties such as tensile, compressive, bending, and crush strength and fracture toughness will be needed as well as swelling and tritium/helium retention behavior. Neutron irradiation testing will be needed to establish behavior over the anticipated operating temperature range (up to and above 1000°C).

Time horizon: Cellular ceramics are advancing in readiness level but will soon require nuclear testing. A comprehensive database as a function of dpa including tensile, compressive, crush strength, creep behavior, and fracture toughness is needed. Progress will be hampered until adequate neutron source testing facilities are established.

Risks and uncertainties: Current scope of ongoing project does not include irradiation testing to establish stability. There is considerable uncertainty in the performance of both liquid and solid breeders currently under development in terms of magnetohydrodynamic flow distribution, high-temperature corrosion, and tritium recovery.

Global strengths and gaps: This technology is being developed in the U.S. and is an opportunity for U.S. leadership in an innovative technology.

4.4.2 Tritium Extraction from Liquid Metal PFCs and Blankets

Overview of Fusion Power Tritium Extraction Challenges

Lithium based liquid metals (LMs) have been studied in the U.S. for the past 40 or more years^{2, 13, 14}. As plasma facing components (PFCs), Li and SnLi have been studied. As blanket tritium breeders, Li and PbLi have been studied. For both applications, the extraction of tritium from these LMs represents an unresolved safety concern. Li is a hydride forming metal. For Li as a LM PFC or breeding material, this attribute significantly reduces the operational safety concern of tritium permeation from the primary heat transport system (PHTS) in to the reactor building; but because Li is very chemically

reactive, tritium concentrations in Li must be kept to low values (< 10 ppm) to avoid excessive environmental releases during accidents that produce Li fires^{1, 15}. Because of the low solubility of tritium in SnLi and PbLi, the concentration of tritium in these LMs must also be kept to a low value (again < 10 ppm) to minimize the operational safety concern of tritium permeating from the PHTS into the facility^{16, 17}. Since tritium concentrations greater than 10 ppm can be achieved in a single pass of the LM through a fusion reactor, either by being implanted by the plasma or bred in the blanket, a very high-efficiency, high-flow, high-temperature extraction system must be developed for the safe operation of these LMs in fusion reactors, for example, extraction efficiency > 80%, flows of ~30,000 kg/s for PbLi (~1,700 kg/s for Li) and temperatures of ~700°C^{16, 18}.

Electrolytic Membrane Extraction Method

Extraction of tritium from liquid Li by electrolytic (ceramic) membranes is a recent proposal^{1, 17}. The difficulty associated with extracting tritium from liquid Li is that this LM readily absorbs tritium to form a LiT molecule with strong molecular bonds. An electrolytic (ceramic) membrane is deemed to be a transformative technology because it directly removes the tritium from the LM, eliminating possible contamination concerns associated with liquid-liquid contact extraction process, such as the one describe in Section 6.6. This proposal also possesses the potential for controlling the speed of the extraction process by adjusting the voltage applied across the membrane.

One white paper proposed¹ a method that employs a lithium ion (Li⁺) conducting ceramic (lithium lanthanum zirconate) membrane to remove tritium from liquid lithium, as illustrated in Fig. 4.4.3. The anode (+) surface of the membrane adsorbs LiT molecules to form Li⁺ and T⁺ ions. The Li⁺ is then conducted through the membrane to a Li pool forming on the backside of the membrane. The tritium left on the anode surface recombines to form bubbles that rise to a cover gas and from there swept to the tritium plant by a sweep gas. A second white paper proposed¹⁷ the used of a proton (T⁺) conducting electrolyte known as perovskite. Similarly, the anode surface absorbs the LiT to form T⁺ and Li⁺ ions, but instead conducts the T⁺ to the cathode side of the membrane, where it is released as T₂ into a sweep gas, or a vacuum, and there swept, or pumped, to the tritium plant.

Technology Assessment: Ceramic Membranes

Level of maturity: Based on the communities' input^{1, 17}, the current TRL for the application of ceramic membranes to extract tritium from liquid metal PFCs and blankets is between TRL2 and TRL3.

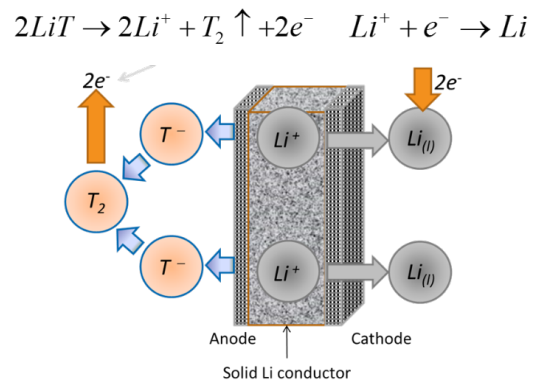

$E_{400^\circ C}^0 = -2.82V \quad E_{400^\circ C}^0 = -3.22V$

Figure 4.4.3: Schematic representation of a Lithium Conducting Electrolytic membrane¹.

Promise and development requirements, and next steps: The proposed Li^+ ion conducting extraction method was clearly stated to be an ex-situ, batch method¹. Thus, it is unclear if this method can be adapted to an in-situ tritium extraction system capable of processing the entire reactor's PHTS LM flow each pass through a fusion reactor. The proposed T^+ ion conducting membrane, if deployed in a vacuum permeator (see next section) has the potential for achieving the desired tritium extraction goals for both Li and Li-alloys. Both ceramic membrane concepts require materials development and high-temperature material performance and compatibility testing. Present U.S. fusion community facilities could be leveraged with investments in these TECs to develop both to TRL 4. Ultimately, tritium blanket and/or extraction test facilities are needed to bring these TECs to TRL 6.

Time horizon: Based on input from¹ the ceramic Li^+ conductor technology development has been underway for ~ 2 years. This test article¹ could produce the required data within the next 2-3 years to bring the Li^+ conducting ceramic to TRL 3. If successful, TRL 4 should be demonstrated within another 3-5 years at the present rate of progress. Development of a T^+ conducting membrane concept has yet to start, but should require the same overall development time as the Li^+ conductor technology to reach TRL 4.

Risks and uncertainties: There are material development risks involved with both ceramic technologies. The stability of the proposed ceramics in fusion LMs needs to be demonstrated at near prototypical conditions. Ceramic membranes introduce the added complexity of supplying electrical current to drive the extraction process. The lifetime of ceramic tritium extraction systems is also uncertain. However, there are drivers external to fusion for developing high-temperature ceramic electrolytic membranes for chemical process applications, including electrolysis of water to produce hydrogen.

Global strengths and gaps: The U.S. is currently leading the effort to develop ceramic electrolytic tritium extraction membranes for LMs.

Permeable Membrane Extraction Method

Proposals for extracting tritium from fusion liquid metal breeders (Li and PbLi) with metallic membranes began in the U.S. almost four decades ago¹⁹. The basic physics behind this concept is that the metallic membrane adsorbs the tritium from the LM. It then diffuses to the opposite side of the membrane and is released as T_2 into a sweep gas that carries the tritium to the fuel processing plant. Group 5 (Nb, Ta, V) metals are well suited for this application because of their high solubility for hydrogen species. One group first tested²⁰ this concept for lithium using a niobium membrane, but found the performance to be unsatisfactory, most likely due to the fact that lithium has a higher solubility for hydrogen than do the Group 5 metals.

The presently accepted concept for tritium extraction from LMs, excluding Li, is the compact-mass-extractor. This technology is produced by the chemical industry and was found to have extraction efficiencies as high as $\sim 30\%$ ²¹. Because this technology requires low LM flow rates and has not been demonstrated to give low T concentrations (<10 ppm), it is not well suited as an extraction system capable of processing the entire reactor LM inventory each pass through the reactor²². Recently, a permeable membrane concept called

a vacuum permeator has been theoretically shown to provide the required tritium extraction efficiency ($> 80\%$), at high LM temperatures ($700\text{ }^{\circ}\text{C}$) and to low concentrations ($< 1\text{ ppm}$) for the entire reactor LM flow each pass through the reactor¹⁶. For these reasons, the vacuum permeator is deemed to have the potential to be transformative. Its application to Li could also be possible if a T^+ conducting electrolytic (ceramic) membrane is used instead of a metallic membrane.

Technology Assessment: Vacuum Permeator

Level of maturity: Based on community input, the maturity level of this concept is approaching TRL 2 in the U.S. and TRL 4 in the European Union.

Promise and development requirements, and next steps: This technology has the potential of meeting all of the tritium extractions requirements for Li-alloy (eutectic) blankets and PFC's. It also has the potential for extracting tritium from Li, if a T^+ ion conducting ceramic membrane is used.

Because of this technology's low level of maturity, materials development, compatibility testing and small LM flow loops are required to demonstrate a TRL of 5. But to achieve a TRL 6, blanket and/or tritium extraction test facilities are needed to validate the vacuum permeator concept.

Time horizon: The time horizon to reach TRL 5 is limited by materials development and level-of-effort. The E.U. has been developing their metallic membrane concept [permeator against vacuum – PAV] for at least six years²³. It could easily take another four years to demonstrate TRL 5 for the PAV technology based on the present progress. This time horizon should also apply to the vacuum permeator.

Risks and uncertainties: There are several material development risks involved with this technology. Group 5 metallic membranes are hydride formers and suffer oxygen embrittlement even at extremely low oxygen concentrations. The lifetime of tritium extraction systems is also uncertain.

Global strengths and gaps: The U.S. is a not global leader in this area; but it could leverage investments in this technology by collaborating with the EU. Note that there are no external drivers for developing this technology.

4.4.3 Tritium Processing of Plasma Exhaust Fuels

Overview of Fusion Plasma Fueling Challenges

A key technology and safety challenge for fusion reactors is the quantity of tritium fuel being processed (2-3 kg for ITER tritium plant) and the rate at which this tritium must be processed (maximum $200\text{ Pa}\cdot\text{m}^3/\text{s}$ for ITER) while at the same time minimizing tritium release to the environment during operation and under accident conditions²⁴. As illustrated in Day et al.³, these challenges only grow in magnitude for a demonstration reactor (DEMO), where the inventory and processing rate are anticipated to increase by a factor of ~ 4 above ITER for a 2 GW fusion power device. The majority ($\sim 80\%$) of this tritium resides in the fuel processing plant's cryogenic isotope separation system (ISS) ($\sim 60\%$) and

on the reactor's vacuum vessel (VV) cryopumps (20%). In addition it is uncertain if cryopumps will prove to be an effective VV pumping option for a steady state fusion reactor like DEMO³. This uncertainty relates to possible reliability concerns for cryopumps given their transient mode of operation, i.e. cycled fuel loading and unloading modes³. A driver of both the fueling plant's tritium inventory and processing rate is the plasma's tritium burn fraction (TBF)²⁵. The predicted TBF is from 0.35% to 1.5% for both ITER and an "ITER like" DEMO reactor^{26, 27}. For the ARIES-ACT1 advanced power reactor concept, the aim is to operate with a TBF in the range of 5.0 to 25.0%, but the physics that supports this adopted TBF range is unexplained²⁸. However, an increase of TBF to 5.0-25.0 % would dramatically reduce the size (inventory and throughput) of a DEMO tritium plant, provided that the increased burnup also applies to the edge fueling (e.g., gas puffing).

A solution called the "Direct Internal Recycling" (DIR) approach has been proposed that has the potential for reducing the DEMO tritium processing plant size to that of ITER's, or 75% smaller³. A key technology proposed for the DIR approach is called a "superpermeable" metal foil pump (MFP)³. The MFP is a steady state, high-temperature vacuum pump that works by directly extracting the unburnt hydrogen fuels from the plasma exhaust, instead of condensing them. Because this extracted fuel is free from plasma exhaust impurities, it can be sent directly to the reactor's fueling system for reinjection into the plasma instead of to the fuel processing plant³.

Superpermeable MFPs Vacuum Pumps

The phenomenon of superpermeation was first observed in 1938^{25, 29}, but development of superpermeable MFP technology did not start in earnest until the mid-1970s^{30, 31}. A metal's permeability is the product of its solubility and diffusivity for a given gas. Metals develop monatomic non-metallic films at their surface, typically an oxide layer that reduces the metal's solubility and thereby its permeability for that gas. Thus, these films act as an additional barrier to the absorption of thermal hydrogen by the base metal. Because plasma exhaust hydrogen atoms will possess sufficiently high energies (~1 eV), the atoms can penetrate beyond the non-metallic film when impinging on the upstream surface, thereby directly bypassing this surface's energy barrier while thermal hydrogen cannot. Such atoms are referred³¹ to as "suprathermal" atoms. Superpermeability has been demonstrated in membranes composed of Ni, Fe, Pd and Nb³¹. But the Group 5 metals (V, Nb and Ta) have proven particularly suited for developing superpermeable conditions.

Technology Assessment: Metal Foil Pump

Level of maturity: Based on community input, the readiness level for MFPs is assessed to be TRL 2 in the U.S. and TRL 4 internationally. Compared to ITER's cryopumps (TRL 8), MFP's pumping speeds are more than a factor of 10 lower than ITER's cryopumps³².

Promise and development requirements, and next steps: This technology could significantly reduce the cost associated with cryogenic pumping systems and reduce the

³ Section 4 of Day et al.³ contains a down-selection discussion that identifies the MFP as a leading candidate for this application.

tritium inventory and throughput of the tritium processing plant by 75%. MFPs are also steady state vacuum pumps, as opposed to cryopumps which are transient pumps. There are no external drivers for this technology at present. Fusion R&D is required to bring the technology to TRL 4 or 5 in the U.S. The development of the membranes needed by these pumps could be greatly enhanced by advances in design and additive manufacturing (see 4.3). But ultimately, to bring this technology to TRL 6 will require specialized vacuum pumping and tritium processing test facilities.

Time horizon: MFP technology is at least a decade behind cryopumps. Thus the time horizon for the U.S. to develop and demonstrate a workable TRL 5 MFP is probably ~10 years. It could take at least an additional decade to bring this technology to TRL 6. This time horizon should make this technology available for post-ITER burning plasma reactors.

Risks and uncertainties: Standoff MFPs, designed to be located away from a plasma, use an atomizer to produce “suprathermal” atoms. These atomizers are composed of Ta wires that show material loss and effectiveness over time. Intelligent technologies for atomizers are needed to produce hydrogen atoms at the appropriate energies³. The stability of the pump’s membrane surface films is also a crucial issue. Oxygen uptake by Group 5 metals could also lead to membrane embrittlement. Recent research has demonstrated that vanadium pumping membrane’s surfaces coated with a second metal, thought to be copper layers³³, may resolve this issue. For up close MFPs, implanted suprathermal helium atoms from the plasma can lead to surface layer embrittlement and charge exchange neutrals that will cause surface sputtering.

Global strengths and gaps: While the U.S. does not have experience in fabricating or testing of MFPs, it does have considerable expertise in understanding the physics of this technology. The U.S. has a very strong materials program that could quickly take a leadership role in developing new atomizer and membrane materials, especial materials tailored for this application through the materials-by-design approach (Chapter 4.3).

References

1. B. Garcia-Diaz, 2017 “*Direct LiT Electrolysis in Molten Lithium,*” *TEC whitepaper*
2. L. El-Guebaly, 2017 “*Neutronics and Tritium Breeding Capability for Liquid Metal-Based Blanket (DCLL),*” *TEC whitepaper*
3. C. Day, and T. Giegerich, 2013 *Fus. Eng. Des.* **88** 616
4. A. C. Klein, 2017 *American Nuclear Society special report 3*
5. 2012 *Opportunities for Fusion Materials Science and Technology Research Now and During the ITER Era* <http://science.energy.gov/~media/fes/pdf/workshop>
6. B. Williams, 2017 “*Robust Cellular Solid Breeder Offering Potential for New Blanket Designs with High Tritium Breeding Ratio,*” *TEC whitepaper*
7. C. W. Forsberg, and P. F. Peterson, 2017 “*Flibe (6Li2BeF4) Blankets to Integrate Heat Production with Electricity Markets Using Nuclear Brayton Combined Cycles,*” *TEC whitepaper*
8. S. Smolentsev, 2017 “*Computational predictive capability for multi-physics, multi-effect MHD,*” *TEC whitepaper*
9. C. Wong, 2017 “*Blanket Design Options and Learning from ITER,*” *TEC whitepaper*

10. L. V. Boccaccini, 2013 *Fus. Eng. Des.* **109** 1199
11. C. P. C. Wong, M. Abdou, and Y. Katoh, 2013 *Fusion Sci. Techn.* **64** 623
12. F. Hernandez *et al.*, 2017 *Fus. Eng. Des.* **124** 882
13. M. A. Abdou, 1999 *Fus. Eng. Des.* **45** 145
14. R. F. Mattas *et al.*, 2000 *Fus. Eng. Des.* **49** 127
15. S. Reyes, 2017 "Enabling Capabilities for Tritium Safety: Transformative Enough?" Presentation to FESAC TEC panel
16. P. W. Humrickhouse, and B. J. Merrill, 2017 *Fus. Eng. Des.*, <http://dx.doi.org/10.1016/j.fusengdes.2017.04.099> at press
17. P. Calderoni, and T. He, 2017 "Extraction of tritium from lithium based liquid metals," TEC whitepaper
18. B. J. Merrill, 2008 *Fusion Sci. Techn.* **54** 838
19. J. S. Watson, 1972 "An evaluation of methods for recovering tritium from the blankets or coolant systems," Oak Ridge National Laboratory report, ORNL-TM-3794
20. S. Tanaka, H. Katsuta, and K. Furukawa, 1981 *J. Nucl. Mater.* **97** 59
21. Alpy N., Terlain A., and L. V., 2000 *Fus. Eng. Des.* **49** 775
22. B. J. Merrill *et al.*, 2014 *Fus. Eng. Des.* **89** 1989
23. B. Garcinuno, 2017 *Fus. Eng. Des.*, <http://dx.doi.org/10.1016/j.fusengdes.2017.02.060>. at press
24. I. R. Cristescu *et al.*, 2007 *Nucl. Fusion* **47** 5458
25. M. Shimada, 2017 "Superpermeable Metal Foil Pump for Increasing Tritium Burn-Up Fraction for DEMO," TEC whitepaper
26. A. S. Kukushkin *et al.*, 2011 *J. Nucl. Mater.* **415** S497
27. A. Loarte, and D. Campbell, 2016 "The Plasma Physics Aspects of the Tritium Burn Fraction and the prediction for ITER," 4th IAEA DEMO Programme Workshop, Karlsruhe Institute of Technology, Karlsruhe, Germany, November 15-18
28. C. Kessel, 2014 *Fusion Sci. Techn.* **67** 75
29. A. Güntherschulze, H. Betz, and H. Kleinwächter, 1939 *Z. Physik* **111** 657
30. A. L. Livshits, 1976 *Sov. Phys. Tech. Phys.* **21** 187
31. A. L. Livshits, 1997 *J. Nucl. Mater.* **241** 1203
32. C. Day, 2004 "Validated design of the ITER main vacuum pumping systems," 20th IAEA Fusion Energy Conference, paper IT/P3-17
33. B. J. Peter, and C. Day, 2017 *Fus. Eng. Des.*, <http://dx.doi.org/10.1016/j.fusengdes.2017.05.124> at press

V. TRANSFORMATIVE ENABLING CAPABILITY FAST FLOWING LIQUID METAL PLASMA FACING COMPONENTS

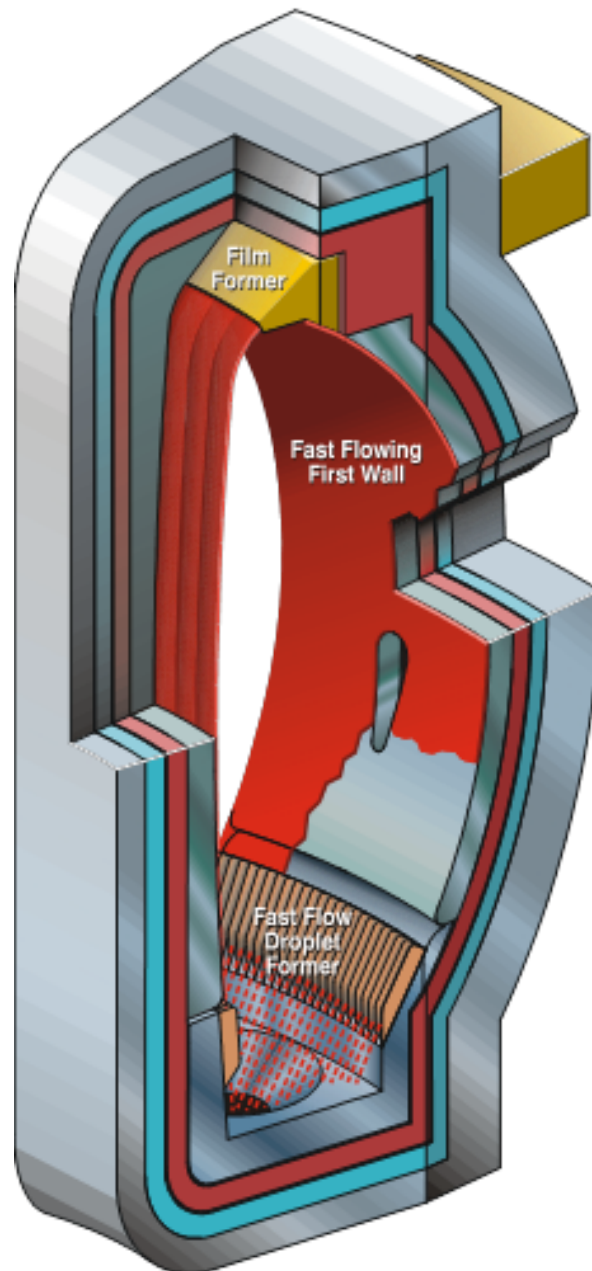

CLIFF Convective Liquid Flow Firstwall
N.B. Morley *et al.*, <http://slideplayer.com/slide/4939850/>

5. Fast flowing liquid metal plasma facing components

Overview

Liquid-metal (LM) PFCs may be the only concept capable of tolerating *both* high steady and transient heat flux in the high-duty cycle and extreme-environment of a fusion reactor power plant, due to the capability of such PFCs to continually replenish material. In addition, liquid PFCs can provide access to low recycling (in the case of lithium), high confinement regimes, e.g. at ≥ 2 times H-mode scaling laws, around which attractive fusion scenarios can be operated¹. Free-surface flowing liquid-metal (LM) systems have been considered to both mitigate erosion and handle large high heat-flux power exhaust from tokamak devices. These systems have also been proposed for application to reactor-level fusion plasmas, which will experience considerable neutron damage, He-ash exhaust and high-duty cycle constraints on solid PFCs (plasma-facing components), ultimately generating several tons of eroded material per year of operation². Because flowing LM systems are self-replenishing, they could remove some drawbacks of solid PFCs. While impurity emission from the liquid surface to the plasma and neutron damage to the existing substrate in the PFC would remain major challenges, flowing LM systems may be able to address the continual erosion/redeposition conditions at the plasma edge. However, for the case of low-recycling LM surfaces, the promise of low-recycling regimes and high retention of hydrogen isotopes is tempered by the challenge of possible tritium uptake and the need for advanced technologies for tritium removal from LM candidate materials, such as lithium or tin. Additional knowledge gaps for LM PFCs include keeping the surfaces clean for reliable flow, counteracting MHD mass ejection forces and possible dry-out scenarios with the underlying substrate, determining operating temperature windows, and demonstrating He ash exhaust. Given the well-known knowledge gaps, the “high payoff” is not yet fully confirmed, while the risk remains high. In addition, the lack of a broad external technology industry driver means that progress requires substantial dedicated resources; for these reasons, the class of fast free-flowing LM concepts is evaluated as “potentially transformative.” On the other hand, industrial involvement could accelerate innovation and commercialization of these technologies; indeed, commercial sector contributions may be a necessary step to realization of this technology in a power plant.

Background

The concepts of a liquid-metal wall used in a fusion reactor goes back to the early 1970’s, both in the U.S.³ and in the U.K.⁴. Other notable work on flowing liquid-metal systems for material protection included the concept of “HYLIFE,” using a flowing liquid molten salt (Flibe) for material protection (in one of its applications) against intense radiation fluxes in inertial fusion systems⁵. The use of liquid metals as candidate free-surface flowing materials for divertor and/or wall PFCs was evaluated by the U.S. APEX and ALPS programs in the late 1990’s^{6,7}. In both programs pioneering work on the performance of liquid-metal PFCs was achieved, including work on LM surface science^{8,9}, plasma-material interactions¹⁰, liquid MHD flow effects¹¹, LM erosion in tokamaks¹², free-surface flowing LM tests stands^{13,14}, and liquid Li divertor in CDX-U experiments¹⁵. These programs grew into more recent experiments that focused on approaches to liquid-metal control, operating temperature ranges, substrate interactions and testing in various high heat-flux plasma and tokamak platforms. A recent review by Nygren and Tabares provides an excellent review

on the subject¹⁶. Computational modeling efforts also have supported the study of LM systems as PFCs and explored the limits of LM flowing vs. static systems and their implications to heat flux management and particle density control. Noteworthy is the multi-physics HEIGHTS code that has provided advanced simulations on liquid-metal interactions with intense plasma conditions¹⁷. In addition, liquid metal MHD effects were investigated computationally and experimentally¹⁸. In addition to free surface-flowing LM systems evaluated in this TEC element, slow-flow or static LM systems supported by textured or porous substrates have also been studied in detail, and were assessed in the Advanced Materials TEC element.

Level of maturity: Flowing liquid-metal technology development remains at TRL levels between 1-2, where most key technological achievements have mostly been focused on basic principles testing and low-level prototyping of non-flowing and partially-flowing liquid-metal fusion wall interfaces. Liquid metal pools such as in CDX-U and the Lithium Tokamak Experiment (LTX) have demonstrated reduction in recycling using liquid lithium with observable effects on fusion plasma confinement, albeit at time-scales of a few fractions of a second¹⁹. With respect to low-recycling regimes it was shown experimentally that liquid lithium systems induced very high edge temperatures²⁰.

Although fully-integrated free-surface flowing LM systems have yet to be demonstrated in an existing tokamak, there are many promising single-platform and single-effect experimental results where flowing LM systems were used as PFCs. Based on computational and experimental work mentioned earlier¹⁷, flowing walls or divertors with speed ~ 1 -10 m/s can remove plasma fluxes above 10 MW/m^2 . Slow flow systems (e.g. speed \sim few cm/sec) require strong substrate cooling to maintain surface temperatures $< 400 \text{ }^\circ\text{C}$, in order to maintain a low recycling surface because hydrogenic retention in liquid lithium plummets above this temperature. High-temperature experiments²¹ on Magnum-PSI demonstrated that super-saturated phases of implanted D can reduce the Li sputter yield and possibly extend the temperature window for Li-based surfaces well above $400 \text{ }^\circ\text{C}$ (Fig. 5.1.1). Understanding of density control with flowing liquid lithium and its effect on energy confinement is still in its infancy. Other single-effect and single-platform experiments have demonstrated some important results of flowing liquid lithium, such the Flowing Liquid Lithium (FLiLi) system also on the EAST tokamak, and the LIMITS system on both Magnum-PSI and EAST. These systems were prototype experiments demonstrating free-surface flowing LM examples exposed to tokamak conditions. However, in the context of fusion reactor energy systems the prototypes are considered only platform experiments at TRL 1-2.

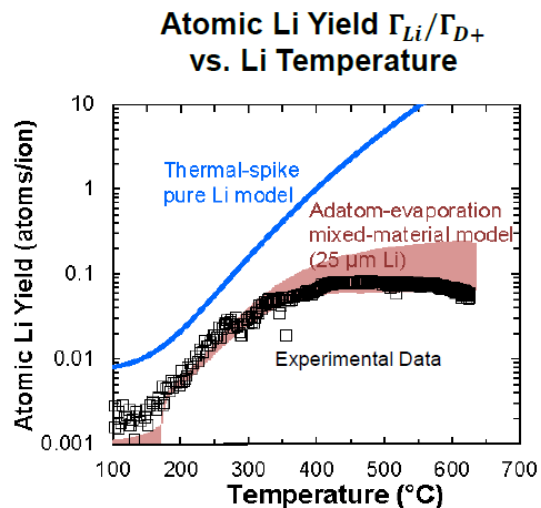

Figure 5.1. Erosion of lithium under high-flux deuterium bombardment as a function of surface temperature. The gross erosion, measured via spectroscopy, can be described with an adatom-evaporation and mixed Li-D material model that takes into account concentration-dependent hydrogen diffusivity in the bulk Li.

Promise and development requirements: One of the most notable promises of flowing LMs is their potential to mitigate SOL (scrape-off-layer) power flow. The scrape-off length for temperature with a low recycling wall, and flat temperature profiles, is effectively infinite. As a result, the power scrape-off length is increased in a low recycling device by an order of magnitude or more, and the peak power loading in the divertor is reduced by a similar factor. Other promising advantages of LMs include:

- Very high steady, and transient heat exhaust: 50 MW/m^2 exhausted from electron beam heating; also pulsed 60 MJ/m^2 in $1 \mu\text{sec}$
- Tolerable erosion from a PFC perspective: self-healing surfaces
- No dust generation
- Eroded chamber material from the main chamber transported to the divertor could be removed via liquid flow
- Neutron/dpa tolerance; underlying substrate would still have neutron-induced modifications, though
- Substrates below LM are protected from plasma-material interactions
- Liquid lithium specifically offers access to low recycling, high confinement regimes in certain surface temperature ranges

Because fewer resources have been invested in LM PFC systems than in solid PFCs, the knowledge gaps are numerous, and categorized broadly as:

- Reliably producing stable LM surfaces and flows
- Understanding and controlling the LM chemistry
- Acceptable temperature windows for specific integrated scenarios: choice of substrate/coolant that is able to provide for LM surface temperature control
- Fuel retention, recycling and removal in candidate liquid metals
- Corrosion issues involving large quantities of LM interfacing with substrate/bulk components at high temperatures
- Wetting vs dry-out effects asymmetric over substrate materials
- Neutron damage of solid-based substrate materials
- Understanding application of LM to a divertor vs. the first wall
- Plasma confinement with liquid metal PFCs at reactor scale

Risks and uncertainties: Many risks and uncertainties exist for flowing liquid-metal systems. Surface contamination remains a challenge, given flow and system residence time scales. Neutron damage to the underlying substrate and the issue of LM dry-out along the substrate due to varying temperature gradients are outstanding issues not understood today.

Time horizon: The time horizon for free-surface flowing LM systems for a high-duty cycle fusion power plant reactor is in the order of a few decades, primarily dependent on studies of flow dynamics of a conducting fluid in a strongly coupled electro-magnetic plasma irradiation environment. In particular, for liquid lithium, the operating temperature window needs confirmation, and a demonstrated method to remove retained tritium needs demonstration. Corrosion and safety issues remain significant obstacles for liquid Li, that perhaps could be addressed by alternate LMs such as Sn-Li alloys or molten salts such as

Flibe. The latter in fact has a strong technology pull from advanced fission nuclear energy reactors currently under significant development.

Global strengths and gaps: With the rest of the world fusion community focusing on solid PFCs, the development of flowing LM PFC is a transformative area that the U.S. currently leads and can continue to lead. Recent developments with the EURO DEMO project are now considering liquid metals as part of their technology portfolio with a focus on liquid Sn PFCs.

References

1. R. Majeski *et al.*, 2006 *Phys. Rev. Lett.* **97** 075002
2. M. G. Bell *et al.*, 2009 *Plasma Phys. Control. Fusion* **51** 124054
3. 1973 “UWMAK-I – A Wisconsin Toroidal Fusion Reactor Design” *Fusion Technology Institute Report UWFDM-68*
4. S. K. Erents, and G. M. McCracken, 1971 *J. App. Phys.:D* **4** 672
5. R. W. Moir, 1995 *Plasma Phys. Contr. Nucl. Fusion Research* **2** 673
6. M. Abdou, 2001 *Fus. Eng. Des.* **54** 181
7. R. F. Mattas *et al.*, 2000 *Fus. Eng. Des.* **49** 127
8. R. Bastasz, and J. A. Whaley, 2004 *Fus. Eng. Des.* **72** 111
9. J. P. Allain, M. D. Coventry, and D. N. Ruzic, 2007 *Phys. Rev. B* **76** 205434
10. R. P. Doerner, 2001 *J. Nucl. Mater.* **290** 166
11. N. B. Morley, 2004 *Fus. Eng. Des.* **72** 3
12. D. G. Whyte *et al.*, 2004 *Fus. Eng. Design* **72** 133
13. J. P. Allain, 2002 *Fus. Eng. Des.* **61** 245
14. M. Nieto, 2003 *J. Nucl. Mater.* **313** 646
15. R. Majeski, 2005 *Nucl. Fusion* **45** 519
16. R. Nygren, and F. Tabares, 2016 *Nucl. Mater. Energy* **9** 6
17. A. Hassanein, 2002 *Fus. Eng. Des.* **60** 493
18. S. Smolentsev, 2017 *Fus. Eng. Des.* at press
19. R. Majeski *et al.*, 2017 *Phys. Plasmas* **24** 056110
20. S. Smolentsev, M. Abdou, and C. Courtessole, 2017 *Magnetohydrodynamics* **53** 411
21. T. Abrams *et al.*, 2015 *J. Nucl. Mater.* **463** 1169

VI. FOUNDATIONAL AND ENABLING ACTIVITIES

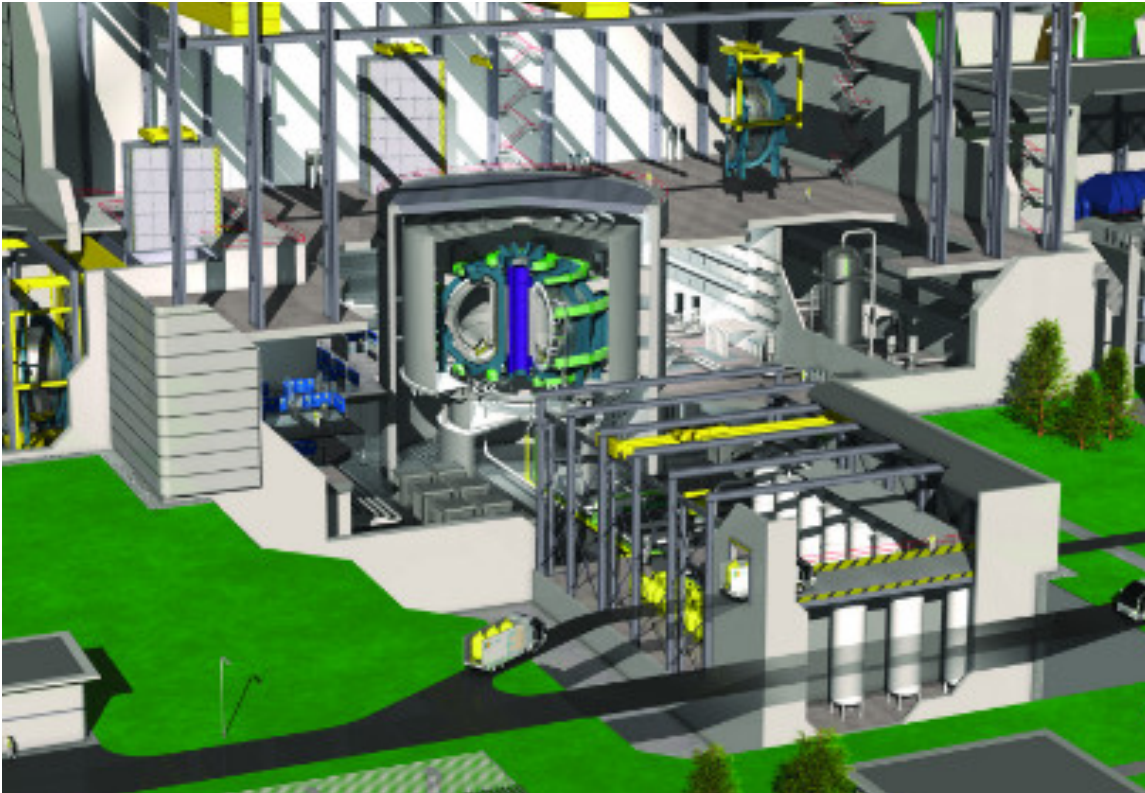

Conception of fusion power plant (© EUROfusion): <https://www.iter.org/sci/Fusion>.

6. Foundational and Enabling Areas

In addition to Transformative Enabling Capabilities described in Chapters 4 and 5, a number of activities were identified as foundational on the path toward a fusion reactor, but not transformative. That is, these capabilities are necessary, and the development of a fusion power plant probably cannot happen if we do not continue to develop them. These necessary elements are largely part of the existing fusion science R&D program and are highlighted here. Also included in this chapter is a discussion of necessary testing facilities. The operation of current facilities, and the development of new facilities, will be essential in order to develop and assess the capabilities included in this report. The table below lists each foundational area described in this chapter, and the TECs that are supported by each foundational area.

Table 6.1: Foundational Area and Supported TECs

Foundational and Enabling Area	TEC(s) that are supported
6.1 Novel Measurements	Advanced Algorithms (Feedback Control) Advanced Materials and Manufacturing (Plasma Facing Component Performance) Tritium Fuel Cycle Control (Tritium Inventory Control Performance) Flowing Liquid Metal PFCs (Plasma Facing Component Performance)
6.2 Current Drive	Advanced Algorithms (Feedback Control)
6.3 Disruption Mitigation and Control	Advanced Algorithms (Feedback Control)
6.4 Exascale Computing	Advanced Algorithms (Feedback Control, Machine Learning, Artificial Intelligence) Advanced Materials and Manufacturing (Materials by Design)
6.5 Advanced Divertor Concepts	Advanced Algorithms (Density Control) High Critical Temperature Superconductors (Poloidal Field Magnet Design) Advanced Material and Manufacturing (Plasma Facing Component Design) Tritium Fuel Cycle Control (Tritium Inventory Control) Flowing Liquid Metal PFCs (Plasma Facing Component Design)
6.6 Tritium and Lithium Safety	Tritium Fuel Cycle Control (Tritium Safety) Flowing Liquid Metal PFCs (Lithium Safety)
6.7 Advanced Power Extraction	Tritium Fuel Cycle Control (High Efficiency Blanket Technology)
6.8 Test Beds for TECs	Advanced Algorithms (Benchmarking) High Critical Temperature Superconductors (Superconductor Performance) Advanced Materials and Manufacturing (Plasma Facing Component Performance) Tritium Fuel Cycle Control (Tritium Inventory Control Performance) Flowing Liquid Metal PFCs (Plasma Facing Component Performance)

6.1 Novel Measurements

Overview

In order to operate a fusion reactor based on the tokamak or stellarator concepts, an extensive set of instruments will be needed to measure the plasma parameters, as well as monitor the first-wall and plasma-facing components. The burning plasma experiment, the ITER tokamak, and currently operating devices such as the W7-X stellarator experiment also in the EU, use instrument sets which may be much more extensive than the minimum set required on a fusion reactor. The measurements needed for diagnosis of fusion power output and real time control of the plasma stability and fusion power output, in a radiation environment, will require high reliability in the measurement systems. Typically, these measurement systems are referred to as diagnostics.

Because of the harsh radiation environment in a reactor, the “radiation hardening” of well-established plasmas diagnostics is crucial¹⁻³. The diagnostic set at ITER faces similar challenges of high levels of neutron and gamma fluxes, neutron heating, particle bombardment, and these diagnostic systems must be selected and designed “to cope with a range of phenomena not previously encountered in diagnostic design”⁴. Extensive design not just of the diagnostic, but also of the radiation shielding requirements, is critical⁵. The harsh reactor environment may introduce insurmountable difficulties for standard plasma diagnostics, such that entirely new diagnostic techniques must be developed. In addition, in a reactor operating in steady state, new diagnostics capable of operating in long-pulse, steady state conditions must be developed, along with diagnostic techniques to monitor in situ the status of the first wall, divertor and any plasma facing components, to ensure that erosion or damage has not become so severe as to affect operations.

Significance to Development of Fusion Power

Reliable, robust diagnostics for a fusion reactor environment are required for development of fusion power. The types of diagnostic techniques needed for a fusion reactor can be grouped in four categories¹. First, there are plasma diagnostic techniques that already exist and have been tested on tokamaks and stellarators, but are not widely used or fielded. These techniques could be used on different facilities/configurations to further validate models and advance scientific understanding. Second, there are techniques that have been developed, but have not been fully tested or fielded on tokamaks and stellarators. This may include both hardware and analysis techniques. Third, existing techniques must be adapted to a new environment, such as burning plasma experiments. Fourth, new techniques must be developed and tested for use in reactors for robust use, reliability, and compactness.

Given realistic estimates for cost and timeline*, it is essential to maintain a robust program of diagnostic R&D for fusion plasmas, with an emphasis on development, deployment and testing of reactor-relevant (radiation-hardened) measurements on fusion devices operating today. One cannot wait until a reactor design has been completed and approved to start planning and developing the diagnostic suite.

Toward this end, the community is interested in understanding “what is the minimum diagnostic suite needed for safe and efficient operation of a fusion reactor?” This is because

“the environmental conditions (e.g., radiation, access, long pulse, etc.) expected in next-step devices will constrain or eliminate the possibility of [using many of the currently used] key measurements”¹. To put it another way, this major open question of whether we can diagnose and control a reactor with fewer measurements than are available now, has driven the development of a new “Grand Challenge” articulated by this panel: *How can we manage uncertainty and incomplete knowledge of key plasma physics elements needed for a fusion reactor?* There is some work on this being carried out, but the panel was only presented this information anecdotally in discussions at the community meetings.

Relevance to Transformative Enabling Capabilities

“Novel Measurements” support the Advanced Algorithms TEC (4.1), since suites of diagnostics and different techniques are combined in practice to perform a desired measurement, often using extensive computations and techniques borrowed from Machine Learning, Artificial Intelligence and Uncertainty Quantification domains⁶⁻¹¹. Novel measurements also support the Advanced Materials TEC (4.3), because in-situ, real time measurement of PFC erosion will be needed¹²⁻¹⁴. In this case, these are new techniques that must be developed and tested for use in reactors. The overlap with advanced materials and advanced manufacturing techniques can also be viewed another way, as one imagines that 3-D printing could lead to construction of new diagnostics¹⁵.

* The timeline and cost for “Novel Measurement” R&D, in terms of new technology development for fusion applications, as presented in a broad, over-view white paper¹, could exceed 20 years and \$100M. This estimate would be relevant both for adapting existing techniques for the reactor environment, as well as developing entirely new techniques. The timeline and cost for radiation hardening plasma and fusion diagnostics for use in a reactor can also be estimated based on the experience from the CERN team, where there is 50 man years of experience operating sensitive instrumentation in a radiation environment⁵. The panel created an estimate for radiation-hardened diagnostic development based on information about CERN, and noted that the timeline could be reduced significantly with proper planning and management. The panel estimates this to be roughly \$12.5M spread over a decade (to create a radiation-hardening plan for a diagnostic suite, and to implement it at a new machine, such as a DEMO.).

6.2 Current Drive Capability for Fusion Devices

Overview

For the tokamak concept to be deployed as a steady state power-producing reactor, it will require effective technologies for non-inductive current drive. Current drive (CD) is essential to sustain the total plasma current, providing the toroidal current needed to complement the bootstrap current naturally present in the plasma core. Furthermore, the localization of driven current has significant impact on the performance and stability of tokamak plasmas. Current that is driven sufficiently off-axis, say between 50% and 80% of the minor radius, is highly valued¹⁶⁻¹⁸. Any CD scheme under consideration for advanced fusion devices will need evaluation in terms of its efficiency (Amperes driven per Watt consumed) and the position of the driven current channel. A candidate CD technique must be compatible with the harsh boundary conditions likely in a high-power fusion device, and must not introduce excess plasma-material interactions or impurity generation.

CD techniques explored in present and past devices include (a) energetic neutral beam injection (NBI), (b) injection of electromagnetic waves, and (c) helicity injection (HI). NBI

has been an effective tool on medium-size tokamaks, but is rarely considered for reactors, since they would have reduced effectiveness, and would displace excessive first wall “real estate” needed for tritium breeding. Wave-based techniques for CD have been explored on existing devices and, their effectiveness has been evaluated for various model reactor concepts¹⁶⁻¹⁸. Various forms of helicity injection have been tried on university and laboratory scale experiments, with limited projection to reactor scale being performed [Raman, Sutherland].

Community input has identified several key innovations and extensions to prior CD development, which would perpetuate leadership of this area within the U.S. program. Helicity injection current drive (HICD) techniques^{19, 20} could be extended to additional tokamaks, and evaluated more thoroughly for extrapolation to reactor scenarios. Several advances in wave-driven current are put forward for testing on the DIII-D tokamak, which would in turn help establish an improved physics basis for their use in burning plasma devices. The “helicon” wave is projected to give improved current drive efficiency over NBI (65kA/MW vs. 15kA/MW), for high electron temperature plasmas¹⁷. A second concept would utilize established technology for electron cyclotron current drive (ECCD), and improve its efficiency (15kA/MW → 28kA/MW) by moving its launch location from the low-field side (LFS) of the plasma to the top of the tokamak¹⁶. Finally, the Lower Hybrid (LH) wave is projected to yield highly efficient CD (~150kA/MW) if launched from the high-field side (HFS) of DIII-D¹⁸. Top and HFS launch concepts would also test the advantages of locating launch structures away from damaging plasma material interactions, which tend to worsen on the LFS, outboard of the tokamak plasma.

Significance to Development of Fusion Power

CD technology will be essential to readying the tokamak for steady-state power generation, and has been a long-recognized opportunity for advancement²¹. Key issues in present devices include high efficiency and radial localization of the driven current. These issues become paramount in a reactor, in which (a) broad current profiles are a requirement for high normalized pressure β_N , and in (b) when the CD power requirement becomes a significant factor in the overall plant efficiency. Insofar as the tokamak is the leading candidate for a power-producing reactor, and there is consensus that a pulsed MFE device is undesirable as a power plant, an efficient and robust tool for CD in a tokamak reactor is a foundational need.

In a steady-state device, CD must have essentially 100% availability, and maintain robust continuous operation in a fusion nuclear environment. Plasma-material interaction and unwanted impurity generation must be minimized, and the application of CD effectiveness must not be compromised by the need to propagate through the boundary plasma of a fusion reactor. Gaps in projection to reactors are most significant in the case of helicity injection, which has to date been demonstrated on relatively low temperature plasmas. Risks and uncertainties in extrapolating wave-based techniques to reactors are also significant, but plans are in progress to explore LFS helicon, top launch EC and HFS LH CD on DIII-D, in the next few years.

Relevance to Transformative Enabling Capabilities

Because off-axis CD is a potentially powerful actuator for controlling the shape of core profiles and regulating plasma stability, it can serve as an enabling tool for the

implementation of *advanced algorithms* for control (Chapter 4.1). Well before reaching the stage of steady-state burning plasma control, flexible CD tools can be deployed on existing devices, in order to expand operational experience and to improve upon reduced models needed for control. This experience would help to develop improved control solutions for confinement and sustainment, and even enable real time control on present devices.

Hardware for CD is often of highly sophisticated design, in particular the specialized launching structures for RF waves used in lower hybrid and helicon concepts. Development of technology solutions for CD can potentially spur effort in the area of *advanced manufacturing*. Both additive manufacturing and advanced materials may in the long run play a necessary role in the development of CD actuators for reactors.

6.3 Actuators for Disruption Control and Mitigation

Overview

The tokamak confinement concept is prone to occasional disruptions in which the plasma stored energy is released on a short timescale with potentially detrimental effects on plasma facing components. Stellarators are much less disruption prone, but a disruption due to a radiative collapse or hardware failure can not be ruled out. Disruption consequences fall under three main categories: thermal loads, mechanical forces, and high-energy runaway electrons, and generally become more serious as device size increases. Occasional (or even frequent) disruptions have been tolerable on smaller experiments but will become increasingly intolerable for ITER, DEMO or a fusion power plant²².

The design of the disruption mitigation system for ITER is currently based on the shattered pellet injection (SPI) concept²³, in which an initially large cryogenic pellet is accelerated by a gas gun, then shattered into small fragments just before entering the plasma. This strategy is preferred over the more widely tested massive gas injection (MGI) method²⁴ because a gas valve would need to be placed quite far from the ITER plasma and would result in very slow delivery time.

The selection of the SPI concept for ITER was based on a small amount of data on a single device, and even some basic physics of SPI is not well understood. There is still significant room for improvement in disruption mitigation actuator concepts for devices beyond ITER (and conceivably for ITER itself), and a significant research effort to advance new concepts should continue given the potential severity of the problem. Possible areas of improvement include (but are not limited to): faster response and delivery time, deeper penetration of impurities, and passive safety strategies (methods not relying on disruption prediction algorithms).

The concept of Electromagnetic Particle Injection (EPI) has been proposed for faster response and delivery time of impurities¹⁹. This concept consists of a rail gun that would accelerate a payload of impurity dust grains to around 1 km/s. The efficiency of the rail gun would be enhanced by aligning it with the background magnetic fields of the device. This concept has been tested off-line on a scale that would be suitable for on-line testing in present U.S. tokamaks.

Other methods for faster particle delivery have been proposed and were described in the Community Input Workshop Report on Transients²⁵. These include a two-stage gas gun, or various types of plasma-jet injection, such as a compact toroid (CT) injector or a plasma nano-particle jet.

The shell pellet injection concept, a hollow sphere of a weakly radiating material filled with a payload of dust grains, has been proposed for deeper penetration of impurities²⁶. Ideally, the shell releases the payload directly in the plasma core to produce “inside-out” cooling of the plasma. Further research is needed both on the manufacture of shell pellets and prediction of ablation characteristics. This method could also be combined with the EPI technique for faster delivery of shell pellets.

A passive method for runaway electron mitigation has been proposed that would deconfine fast electrons even in the event that the disruption warning algorithm failed. This consists of a passive 3D coil or 3D zones of high resistance in the vessel that would produce large 3D perturbing fields in the event of a current quench²⁶. Modeling to understand the structure and amplitude of required 3D fields is still needed for this concept, followed by online testing. Incorporation of high-resistance zones into the vessel wall of an existing tokamak would be a significant retrofit, such that a separate passive coil is a more likely first test for this concept.

Significance to Development of Fusion Power

The disruption challenge is a crucial issue that needs to be resolved for fusion reactors, and could in particular become a deal-breaker for tokamak reactor concepts if a viable solution is not developed. For this reason, disruption actuators truly constitute an enabling element in fusion energy research. A number of promising new concepts have been proposed, and generally none has more than a ~5 year time horizons to be brought to TRL6. The U.S. has been a clear leader in developing and testing disruptions mitigation strategies and should continue in this leading role. Still, the limited availability of domestic tokamaks for testing new concepts and the desirability of testing on larger devices (such as JET) will demand significant international collaboration on this effort.

Relevance to Transformative Enabling Capabilities

Essentially all disruption mitigation strategies rely on the injection of massive amounts of some impurity species (possibly along with deuterium), potentially in conjunction with plasma-control strategies, 3D magnetic fields, or plasma wave interactions for runaway electron suppression. Material injection depends on highly reliable disruption prediction algorithms to be effective, and must have response and delivery times commensurate with the pre-disruption warning times that the prediction algorithms can produce.

6.4 Exascale Computing

Overview

Exascale computing will provide a two-to-three order-of-magnitude increase in computing power from current capabilities, and will enable simulations previously inaccessible to domain scientists. However, achieving this increase faces significant technical challenges, not least the amount of electrical power needed to run these machines. At current levels of

power use, an exascale supercomputer would require 1GW to run, i.e., a whole power plant. Current efforts in the computer science community are focused on delivering the promised computational increase at a fraction of the power needed by current supercomputers. This will demand breakthroughs in computer science that are not yet a reality, and which will introduce additional demands in our algorithms for efficiency, accuracy, and reproducibility.²⁷ (One of the main consequences of lower power consumption is the decrease in resiliency in the hardware, i.e., the increase in frequency of soft and hard faults that will result in significant computation variability and lack of reproducibility).

Significance to Development of Fusion Power

Exascale Computing has great potential for fusion science²⁸, potentially contributing to at least three main areas:

1. Simulation
2. Design, optimization, Uncertainty Quantification (UQ)
3. Operation & Control

Simulation. An important impact of exascale computing will be a substantial increase in the fidelity of current simulation tools to predict fusion plasma behavior (e.g. with current model-building efforts towards “whole device modeling”), design new materials, and new engineering components and facilities. In regards to plasma modeling²⁸, the advent of novel computing architectures for fusion science exascale computing will routinely enable the coupling of macroscopic (reduced, “engineering”) models with higher-fidelity kinetic descriptions²⁹. This will impact all areas of magnetic fusion modeling, including disruptions, plasma boundary, and whole-device modeling. While some individual modules needed for whole-device modeling do not require exascale computing, the efficient combination of such modules does require exascale computing. The availability of higher-fidelity simulation capabilities enabled by exascale will impact our ability to explain, predict, and anticipate plasma behavior in a variety of circumstances, which will have direct impact on our ability design, operate, and control magnetic fusion devices.

Beyond plasma physics, materials and facilities are the ultimate frontier in making fusion a reality on Earth. Exascale computing will allow modelers, engineers, and material scientists to explore the available parameter space much more efficiently and comprehensively. For instance, exascale computing will greatly aid in the exploration and characterization of synthetic materials (e.g. materials by design), even before actual synthesis in the laboratory.

Design, optimization, and UQ. The inclusion of current and future high-fidelity forward-simulation plasma modules enabled by exascale computing in optimization and UQ loops, in combination with (e.g. to inform) other technologies such as machine learning, can revolutionize fusion-device design simulators.

The ability to customize designs based on such high fidelity modules, either stand-alone or in combination with other technologies, such as machine learning, can allow the designer to sample a much larger parameter space than is possible with current approaches. This, in turn, can result in revolutionary fusion reactor designs.

Operation & control. Given the large power demands of exascale machines, it is deemed unlikely that such supercomputers will be devoted to fusion reactor operation on a routine basis. However, it is certainly possible that exascale computing may advance real-time operation and control modules by distilling large simulation databases into lightning-fast algorithms that identify safe operational regimes to guide experiments. In particular, we see significant potential in the combination of exascale computing and machine learning in this regard^{6, 7, 9-11, 26, 30-32}. For instance, exascale computing could be used to inform (train) machine-learning modules either with past experiments, with simulations, or a combination thereof. The actual experiments will be informed by the machine-learning software, but the training could be provided by targeted exascale computing simulations, and the training itself could be performed on exascale machines as well.

Relevance to Transformative Enabling Capabilities

The development of exascale computing is essential to enable the Advanced Algorithms (Chapter 4.1) and is critical to the development of Advanced Materials (Chapter 4.3).

6.5 Advanced Divertor Concepts for Fusion Devices

Overview

A large variety of fusion specific challenges depend on the actual plasma state obtained in the divertor region of a fusion device. The most prominent example is the incoming heat flux, which is limited to 10-20 MW m⁻² due to technical constraints on the material integrity and cooling performance to avoid structural damage (see section 4.3 on “Advanced Materials”). Also, divertor electron temperatures below 5eV have to be obtained to avoid excessive erosion. Lastly, impurities have to be retained and exhausted in the divertor. Advanced divertor concepts, which are the subject of intense research in tokamak devices, promise to spread the heat flux and at the same time provide enough flexibility in the magnetic structure that volumetric heat dissipation and reduction of eroding particle fluxes can be accomplished. The generic character of finding an appropriate, integrated divertor solution is further emphasized when considering the divertor concepts for stellarators, which is a recent area of research. This section is based on white papers³³⁻³⁵.

Significance to Development of Fusion Power

Without realizing a plasma state compatible with plasma facing components, no fusion reactor can operate on economically viable scales. The heat flux has to be managed to tolerable levels, impurity production has to be minimized and full density control and helium ash removal has to be realized. Hence, finding an appropriate divertor solution still is a key element in realizing an economically viable fusion reactor concept. Both main lines of magnetic confinement fusion have specific questions, which need to be addressed.

For the tokamak, optimization of divertor target angles, shapes and the divertor volume has been conducted. Recent focus has turned to adapting the magnetic structure such that magnetic field flaring spreads heat fluxes, reduces the impact energy of the target particle flux and avoids pinching impurities into the confined plasma. Such snowflake and X-divertor concepts are being explored and can be categorized as a technical readiness level (TRL) of 2. However, no integrated solution of these concepts at reactor-relevant parallel heat and particle flux densities can be tested presently, also not on ITER. The same applies

for the two existing divertor concepts for stellarators, which so far can be classified as a TRL 1. Because stellarator devices have been operating at low power and particle flux densities, geometrical optimization is still commencing, along with identifying the stellarator configurations with the best confinement properties.

The next step is to test these concepts under high heat load conditions with appropriate neutral pressure and the relevant partially detached plasma state for reliable heat flux control. The Snowflake, X-divertor and super-X divertor are U.S. inventions and the first two have been tested extensively on U.S. facilities. A dedicated tokamak-based divertor test facility would capitalize on the existing strong knowledge base in the U.S. program and expand U.S. leadership in the field. With such a facility, testing of these emergent divertor concepts could commence, addressing a critical gap in the worldwide fusion program, i.e. to assess these new divertor concepts under reactor-relevant plasma conditions.

Relevance to Transformative Enabling Capabilities

Studies of the divertor performance are enabling in that the divertor conditions define the environment in which advanced materials have to survive. Optimization of divertor solutions should directly relax requirements on heat load requirements of materials (Chapters 4.3, 5.1), as well as impurity and density control actuators and steady-state tritium handling capabilities (Chapters 4.1, 4.4). In addition, the feasibility of advanced divertor concepts, which require substantial volume in the vacuum vessel of the device, rely on technically feasible access for divertor target maintenance and replacement. This capacity may be enabled by the emerging field of high-temperature super-conductors (Chapter 4.2), because of the facilitated demountable joint technology of HTS.

6.6 Tritium and Lithium Safety

Overview

The quantities of tritium to be bred, extracted, and stored for fusion reactors will be orders of magnitude greater than those of present commercial applications. If enabling technologies associated with tritium safety, including tritium breeding, storage, handling, and accountancy and the state-of-the-art computational tools required for licensing analyses are not sufficiently developed, resulting regulatory and licensing issues (not to mention public perception) could significantly hamper the development of a fusion power plant.

According to a TEC white paper³⁶, presently, the U.S. fusion safety and environment (S&E) capabilities have been demonstrated to be world-class. However, when assessing if the U.S. S&E understanding is advanced enough to license a future U.S. DEMO, a number of knowledge gaps have been identified by the FESAC Priorities Panel, two of which are in: 1) Understanding and quantifying the fusion source term that will be required for licensing activities, and 2) Computational tools³⁷ needed to analyze the response of a fusion system to an off-normal event or accident³⁶. Based on this input, enabling technologies were identified that can reduce the gaps in these areas. These enabling technologies are discussed in the following subsections.

Significance to the Development of Fusion Power

Tritium extraction: Presently, the envisioned process for extracting tritium from DEMO liquid Li PFCs or blankets is the one developed and demonstrated on a benchtop scale³⁸. This extraction process mixes in a tank (contactor) the tritium bearing liquid Li with a molten salt that possesses a higher affinity for tritium than does Li, then separates the Li from the molten salt with a separator (centrifuge), and finally sends the tritium laden molten salt to an electrolysis system to remove the tritium from the molten salt. However, even though this is a foundational enabling technology little development has occurred for the past four decades. An experimental study recently examined the separation step of this process at high temperatures with some success by using a centrifuge³⁶. While successful, additional study is required to accurately quantify the efficiency of this separation process over a wide range of mixture flows and temperatures. This technology is still below TRL 4. The same point was also demonstrated for enabling extraction for tritium from liquid metals in Section 4.4.2.

Tritium processing: The hydrogen isotope separation system (ISS) technology presently envisioned for DEMO is that adopted for ITER, which is based on cryogenic distillation columns. An enabling technology that could reduce the cryoplant burden associated with cryogenic ISS columns and the overall size of the tritium plant, but not necessarily its tritium inventory, has been proposed^{36, 39}. This technology, known as thermal cycling absorption process (TCAP) technology⁴⁰, could replace cryogenic distillation columns. TCAP is operated by switching between hydrogen absorption and release by thermally cycling the column from -30 °C to 120 °C, and for these temperatures does not require cryogenic helium to operate. Cascading columns in sequence can achieve⁴⁰ separation of H, D, and T.

Computational tools: At the present time, the modified MELCOR computer code for fusion lacks the capability of detailed 2-D and 3-D fluid flow calculations. This was identified³⁹ as a potential analysis gap for analyzing fires resulting from large lithium spills in LIFE's confinement building.

Relevance to Transformative Enabling Capabilities

The foundational and enabling tritium extraction and processing technologies described in this section support the transformative capabilities Chapter 4.4 by providing promising low reward alternatives that address the same safety and operational issues associated with a DEMO fusion power plant. The “promise and development requirements, and next steps” in the vacuum permeator section of Chapter 4.4, proposes that technology options should be considered in order to minimize the risk associated with metal foil pumps. The TCAP technology above clearly qualifies as one possibility. State-of-the-art computational licensing tools approved by regulatory agencies for licensing are essential to demonstrate the safety of future fusion power plants, regardless of the technologies used to build these plants. There is an emerging licensing analysis method for fission reactors that merges safety assessment methodologies for off-normal event identification with accident analysis tools, such as the MELCOR code. This approach is called the Risk Informed Safety Margin Characterization (RISMC) method⁴¹. The appeal this approach offers to regulators is that not only is the approach to a safety limit determined, for example allowed tritium release, but the statistical margin to this limit is also derived. RISMC study requires, and can directly take advantage of, exascale computing power.

6.7 Advanced Power Extraction Techniques

Overview

Currently envisioned fusion power systems are amenable to exploiting very favorable high-temperature heat cycles such as Brayton or combined Brayton/bottoming cycles that have a higher thermodynamic efficiency (η_{th}) than the current generation of fossil fuel or nuclear power plants. This is due to the use of coolants such as helium, liquid metals, and molten salts that are compatible with very high temperatures, along with the expected development of advanced materials that will have the required strength and corrosion characteristics at the high temperatures involved.

An example presented in Figure 6.7.1 is the Supercritical CO₂ Brayton Cycle⁴² with $\eta_{th} \sim 60\%$. High performance is achieved by optimizing the recuperation scheme to maximize heat recovery between various streams, and reducing the compressor inlet temperature to near the critical point which reduces the compression work required by a factor of ~ 3 .

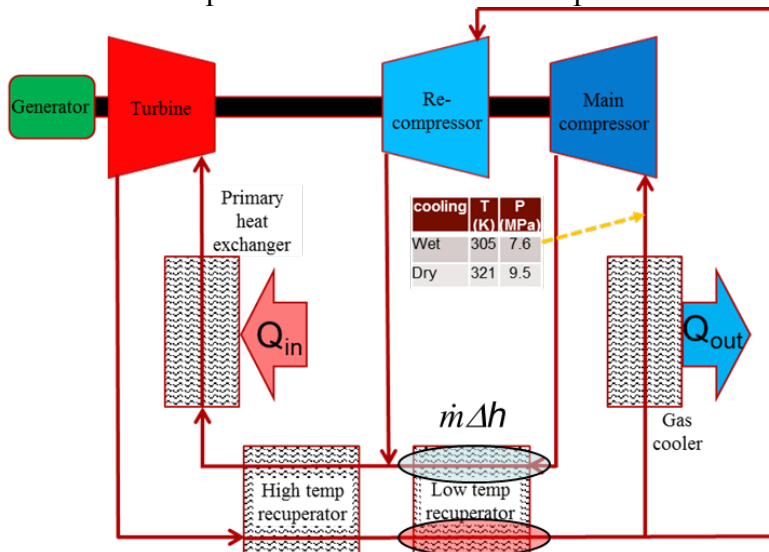

Figure 6.7.1. Supercritical CO₂ Recompression Closed Brayton Cycle diagram: the flow is split at points to optimize the thermal capacities of the heat-exchanging streams.

Systems based on molten salts also offer the promise of very high temperature operation and η_{th} near 60%. The Nuclear air Brayton combined cycle (NABCC) is an example⁴³. This cycle is interesting for achieving considerable load following flexibility by including the use of high-temperature energy storage in an insulated silo containing a large mass of firebricks. Fusion-derived nuclear heat is coupled by molten salt coolant to heat exchangers that provide heated air to Brayton cycle turbines or the heat storage system as shown in Figure 6.7.2.

Many aspects of these high-efficiency cycles are well-developed and use current technology of high TRL. The high temperature requirement, however, lowers the overall system TRL considerably because of reliance on as-yet undeveloped (low TRL) structural materials with the necessary strength and chemical compatibility for the conditions. At the moment, the only metals that show promise for use above 650°C are costly alloys based on nickel.

scientific progress. Early career researchers and students should be encouraged to pursue this unusual but valuable mix of skills.

The TEC elements need facilities for testing and development. Developing of materials with advanced manufacturing requires test facilities to qualify them for plasma facing materials, structural materials and functional materials in the fusion environment. All of the materials need to undergo irradiation tests, in addition to testing to evaluate corrosion and chemical compatibility. Since a high flux fusion neutron source is currently not available worldwide, irradiation tests have to be performed on existing high flux fission neutron sources and existing spallation neutron sources. Upgrades to existing facilities are recommended to get information on radiation damage closer to the fusion neutron spectrum. It is essential to maintain and support a robust diagnostic capability to enable the analysis of neutron irradiated material samples. In addition, for the testing, development and qualification of plasma facing materials and components a large suite of fusion relevant test facilities is required. This includes linear plasma devices to expose materials and components to divertor relevant plasmas (fluxes, electron temperatures and electron densities). As identified in previous reports⁴⁴⁻⁴⁶, an upgrade of existing linear devices or a new build is necessary to expand the existing capabilities to fusion relevant ion fluxes, fusion reactor divertor relevant plasma parameters, and handling of neutron-irradiated material samples. Divertor and first wall plasma facing components need to be tested to high heat fluxes. This can be done in linear plasma devices. However, other high heat flux test stands could and should supplement this capability to enable a faster development turn-around. Typically, such devices, (electron beams or neutral beams) can reach higher heat fluxes, providing a critical testing capability for pushing high heat flux components enabled by advanced manufacturing. These test stands need to be complemented by test stands for thermo-mechanical testing, e.g. creep and fatigue.

High Temperature Superconductors (HTS) will also require testing facilities. Although a few test beds exist in the U.S., the most suited ones to test magnets of a larger scale are international facilities like the one in Switzerland, Sultan, or the one in Saclay, France. Within this assessment, no recommendation towards a U.S. test bed for larger scale magnets is given. However, it would be beneficial for the development of HTS magnets to engage in the development of larger HTS coils for a DoE supported experiment, as well as to begin a comprehensive test of neutron-induced performance degradation of HTS.

The Advanced Algorithms TEC mainly relies on High Performance Computing (HPC) facilities. New generation HPCs are coming online through the Exascale Project at DOE, which should provide architecture ideally suited for Artificial Intelligence and Deep Learning. This opens the door to novel algorithms.

In the 10-year strategic plan provided by the FESAC report⁴⁷, fundamental fuel-cycle research is explicitly mentioned as an element of a fusion nuclear science subprogram. The fuel-cycle research is needed to develop a feasible tritium breeding and power-conversion blanket/first-wall concept, and requires a number of facilities for evaluating tritium processing and permeation. Likewise, test facilities and modeling capability are required to assess possible power conversion concepts that may improve the electrical efficiency of a fusion power plant, thereby decreasing cost. This 10-year FESAC report summarized the needs this way: “Fundamental research is needed to identify a feasible tritium fuel-cycle

and power-conversion concept, including improved understanding of the permeation and trapping of tritium inside candidate coolants and fusion materials, exploration of viable methods for efficiently extracting tritium from hot flowing media, and improved understanding of complex magneto-hydrodynamic (MHD) effects on the flow of electrically conductive coolants in confined channels.”⁴⁵

Acquisition of new knowledge and capability in all of these fusion nuclear science research areas is needed in order to provide the scientific basis for the conceptual design of a fusion nuclear science facility. Likewise, Zinkle et al.⁴⁵ identified the need for a fuel cycle development facility. This would be a hydrogen/deuterium facility only. This facility would be used to develop aspects of the fuel cycle without using tritium. The technologies to be tested are partially addressed below, and cover fueling and pumping technology, storage, reprocessing, and breeding technology. In addition to a test facility, a complete fuel cycle model needs to be developed in order to have a design tool for future fusion systems and optimize the function of the different subsystems.

Furthermore, two new facility needs were identified in the Zinkle report⁴⁵. These were (a) the Blanket Thermomechanics Thermofluid Test Facility, which is most likely a new facility and not an upgrade to an existing facility. It will most likely need superconducting magnets to produce a significant field for a large scale (test mockups of prototypical size) liquid PbLi loop test loop. And (b): the need for a Tritium Breeding and Extraction Facility was identified. This facility will irradiate breeding blanket modules with neutrons and extract the resulting tritium. This facility should be as small as possible to integrate it in existing neutron irradiation test facilities, but large enough to demonstrate the essential integrated features of these facilities. Smaller mechanical testing facilities to evaluate the degradation of materials as a result of coupled high-temperature creep and fatigue are also required.

References

1. R. Boivin, 2017 *"Diagnostic Enhancements for Fusion Development," TEC whitepaper*
2. L. Delgado-Aparacio, 2017 *"Burning-plasma diagnostics: photon and particle detector development needs," TEC whitepaper*
3. N. Luhmann, 2017 *"Harsh Environment Microwave Diagnostics for Reactor Plasmas," TEC whitepaper*
4. A. J. H. Donne et al., 2007 *Nucl. Fusion* **47** S337
5. K. Vetter, 2017 *"Radiation Hardening of Electronics and Instruments for Fusion," TEC whitepaper*
6. M. Churchill, 2017 *"Accelerating fusion science with an end-to-end analysis framework for remote, large-scale, near real-time analysis," TEC whitepaper*
7. R. Granetz, 2017 *"Machine learning methods applied to disruption prediction," TEC whitepaper*
8. P. Rodriguez-Fernandez, 2017 *"Accelerated Validation of Quasilinear Transport Codes via Machine Learning Strategies," TEC whitepaper*
9. L. Reusch, 2017 *"Developing integrated data analysis techniques to optimize diagnostics for burning plasmas," TEC whitepaper*

10. A. Scheinker, 2017 *"Adaptive feedback control for automated plasma diagnostics and control systems," TEC whitepaper*
11. E. Schuster, 2017 *"Reactor-like Control integration by model-based real-time optimization," TEC whitepaper*
12. T. Biewer, 2017 *"In-situ, Real-Time Measurement of Plasma Facing Component Erosion using Digital Holography", TEC whitepaper*
13. R. Lunsford, 2017 *"Fiber-Coupled Multiwavelength Raman Spectroscopy for in-situ examination and diagnosis of plasma facing components," TEC whitepaper*
14. R. Nygren, 2017 *"Advancing Fusion Power – Smart Tiles and Fast Data," TEC whitepaper*
15. C. Romero-Talamas, 2017 *"Additive Manufacturing of Plasma Diagnostics: Opportunities and Challenges of a New Paradigm in Experimental Plasma Science," TEC whitepaper*
16. X. Chen, 2017 *"Top Launch Eccd Enabling Higher Off-Axis Current Drive For Steady-State Operation Of Burning Plasma Tokamaks," TEC whitepaper*
17. R. Pinsker, 2017 *"Helicons For Core Current Drive For Reactors," TEC whitepaper*
18. S. J. Wukitch, 2017 *"Path Towards RF Sustainment Of Steady State Fusion Reactor Plasmas," TEC whitepaper*
19. R. Raman, 2017 *"Development Of A Transient Coaxial Helicity Injection For Solenoid-Free Plasma Start-Up And Subsequent Non-Inductive Sustainment," TEC whitepaper*
20. D. A. Sutherland, 2017 *"Steady, Inductive Helicity Injection For Efficient Sustainment Of Stable Toroidal Plasmas," TEC whitepaper*
21. 2007 *"Priorities, Gaps and Opportunities: Towards A Long-Range Strategic Plan for Magnetic Fusion Energy," Fusion Energy Sciences Advisory Committee (FESAC) Greenwald Panel Report, October 2007*
http://science.energy.gov/~media/fes/fesac/pdf/2007/Fesac_planning_report.pdf
22. K. Ikeda, 2007 *Nucl. Fusion* **47** S1
23. N. Commaux *et al.*, 2016 *Nucl. Fusion* **56** 046007
24. M. Lehnen *et al.*, 2015 *J. Nucl. Mater.* **463** 39
25. 2015 *Report of the Workshop on Transients,*
https://science.energy.gov/~media/fes/pdf/program-news/Transients_Report.pdf
26. N. Eidietis, 2017 *"Transformative Disruption/Mitigation Solutions," TEC whitepaper*
27. 2014 *"Applied Mathematics Research for Exascale Computing," DOE-ASCR report*
28. 2015 *Report of the Workshop on Integrated Simulations for Fusion Energy Sciences,* https://science.energy.gov/~media/fes/pdf/workshop-reports/2016/ISFusionWorkshopReport_11-12-2015.pdf
29. L. Lao, 2017 *"Extreme-scale computing with emphasis on high-fidelity physics leading to reduced models for plasma simulation and control technology," TEC whitepaper*
30. J. Hittinger, 2017 *"Advanced Computing as a Transformative Enabling Capability," TEC whitepaper*
31. E. Kolemen, 2017 *"Real-time stability analysis and control for disruption-free operations," TEC whitepaper*
32. J. Schneider, 2017 *"Machine learning, artificial intelligence, and robotic reasoning," TEC presentation*

33. D. Brunner, 2017 "Developing a reactor power exhaust solution by testing advanced divertors in a compact divertor test facility," *TEC whitepaper*
34. B. LaBombard, 2017 "Long-leg divertors with secondary x-points: a potential solution for divertor heat flux and PMI challenges – aided by the development of demountable HTS magnets," *TEC whitepaper*
35. H. Y. Guo, 2017 "Development of advanced divertor concepts for steady-state tokamaks," *TEC whitepaper*
36. S. Reyes, 2017 "Enabling Capabilities for Tritium Safety: Transformative Enough?," *Presentation to FESAC TEC panel*
37. B. J. Merrill, P.W. Humrickhouse, and M. Shimada, 2016 *Fus. Eng. Des.* **109** 970
38. V. Maroni, 1975 *Nucl. Tech.* **25** 83
39. S. Reyes, 2012 "LIFE Tritium Processing: A Sustainable Solution For Closing The Fusion Fuel Cycle," *LLNL report LLNL-TR-576952*
40. X. Xiao, L. K. Heung, and H. T. Sessions, 2015 **67** 643
41. C. Smith *et al.*, 2015 "Risk-Informed Safety Margins Characterization (RISMC) Pathway Technical Program Plan," *INL/EXT-11-22977, rev. 3*
42. G. Rochau, 2017 "Advanced energy conversion cycles," *TEC whitepaper*
43. C. W. Forsberg, and P. F. Peterson, 2017 "Flibe (6Li2BeF4) Blankets to Integrate Heat Production with Electricity Markets Using Nuclear Brayton Combined Cycles," *TEC whitepaper*
44. 2009 "Research Needs for Magnetic Fusion Energy Science," *Report of the Research Needs Workshop (ReNeW) report, June 9-13, 2009.*
45. 2012 *Opportunities for Fusion Materials Science and Technology Research Now and During the ITER Era* <http://science.energy.gov/~media/fes/pdf/workshop>
46. 2015 *PMI Community Workshop Report*,
http://science.energy.gov/~media/fes/pdf/workshop-reports/2016/PMI_fullreport_21Aug2015.pdf
47. 2015 "The Office of Science's Fusion Energy Sciences Program: A Ten-Year Perspective," https://science.energy.gov/~media/fes/pdf/program-documents/FES_A_Ten-Year_Perspective_2015-2025.pdf

VII. APPENDICES

7. Appendix A - Charge Letter



Department of Energy
Office of Science
Washington, DC 20585

Office of the Director

JAN 30 2017

Dr. Donald Rej
Program Director
Office of Science Programs at LANL
Los Alamos National Laboratory, MS-A121
Los Alamos, NM 87545

Dear Dr. Rej:

First, let me thank you for accepting the task of chairing the Fusion Energy Sciences Advisory Committee (FESAC) at this important time for the Fusion Energy Sciences program. We have considerable work ahead that will require thoughtful, informed advice regarding the future of fusion and plasma sciences in the United States.

It is necessary that the U.S. program be in the best position possible to lever the science and technology that will be advanced through burning plasma research on ITER. It will be important that we are involved in pursuits that give us the best chance of enabling the knowledge gained through ITER research to be effectively levered towards attractive fusion energy.

I am asking FESAC to identify the most promising transformative enabling capabilities for the U.S. to pursue that could promote efficient advance towards fusion energy, building on burning plasma science and technology. Your considerations should be broad, addressing advances that may occur in areas of engineering, technology, and science. Examples of focus areas could include liquid metals, additive manufacturing, high critical-temperature superconductors, exascale computing, materials by design, machine learning and artificial intelligence, and novel measurements. Please comment on the promise, level of maturity, development requirements, risks and uncertainties, and time horizon for each. Please consider global strengths and gaps in identifying areas of particular opportunity for the U.S.

We particularly seek examination of developments that can bring the tokamak and stellarator concepts closer to producing fusion power practically. Identification of R&D that may have general impact that both includes and extends beyond these concepts is welcome, but an assessment of various types of magnetic confinement devices is not to be performed.



Printed with soy ink on recycled paper

The subcommittee you establish to address this charge might find it useful to review prior studies. For example, the 2015 DOE report entitled: "The Office of Fusion Energy Sciences Program: A Ten Year Perspective" highlighted five areas of critical importance for the U.S. fusion energy sciences enterprise over the next decade. The FESAC report "Priorities, Gaps, and Opportunities," issued in 2007, identified gaps in the world's magnetic confinement fusion program and potential initiatives the U.S. might undertake to assert leadership in select areas. The 2009 ReNeW report built on this analysis.

Please submit your report to the Director of the Office of Science by October 1, 2017.

Sincerely,



J. Stephen Binkley
Acting Director
Office of Science

7. Appendix B - FESAC TEC Subcommittee Membership

Rajesh Maingi (PPPL) – Chair

Arnold Lumsdaine (ORNL) – Vice-Chair

Don Rej (LANL) & Stephen Knowlton (Auburn – emeritus) – FESAC ex-officio members

Sam Barish (FES) – FES liaison

A. Plasma Diagnostics, Actuators, and Control (Physics and computation)

- *Anne White (MIT) – sub-panel lead*
- Luis Chacon (LANL)
- Steve Gourlay (LBNL)
- David Humphreys (GA)
- Val Izzo (UCSD)

B. Plasma Materials Interaction (Material science and engineering)

- *Jean-Paul Allain (U. Illinois) – sub-panel lead*
- Juergen Rapp (ORNL)
- Oliver Schmitz (UW-M)
- Chris Spadaccini (LLNL)
- Zhehui (Jeff) Wang (LANL)
- Brian Wirth (UT-K)

C. Reactor and Balance of Plant (Mechanical, electrical, and nuclear engineering)

- *Charles Greenfield (GA) – sub-panel lead*
- Jerry Hughes (MIT)
- Harry McLean (LLNL)
- Jon Menard (PPPL)
- Brad Merrill (INL)

7. Appendix C - Application of Technology Readiness Level

Overview

The charge requested comment on the “level of maturity” of the focus areas that are identified as transformative. One method for assessing maturity for a specific technology is the Technology Readiness Level (TRL). The concept of the TRL was developed by NASA in the 1970’s and 1980’s¹, and has been adopted by a variety of other agencies, including the Department of Defense² and the Department of Energy³. The Department of Energy has employed the use of TRLs through its Critical Decision (CD) process for Major System Projects³. Prior to CD-1 approval (conceptual design review), “it is recommended that all Critical Technology Elements (CTEs) of the design should have reached at least TRL 4 . . .”³. At least 90 days prior to reaching CD-2 (preliminary design review), an assessment should be performed “to independently assure that CTEs have in fact reached TRL 6 . . .”³.

Summary of TRLs

The purpose of TRLs is to “provide a systematic and objective measure of the maturity of a particular technology”⁴. The TRL scale goes from TRL 1 (basic research) through TRL 9 (system in operation). The different levels can be briefly summarized as follows:

- TRL 1 – pure research
- TRL 2 – applied research
- TRL 3 – laboratory testing of individual components
- TRL 4 – laboratory testing of integrated components
- TRL 5 – field testing of integrated components (lab scale)
- TRL 6 – field testing of scale prototype
- TRL 7 – full-scale testing of prototype in cold conditions
- TRL 8 – system completed and qualified through test and demonstration
- TRL 9 – actual system operations in full range of conditions

Table C-1 below indicates the scale of testing, the fidelity of testing, the testing environment, and the development stage for each of the TRLs (This is taken from DoE TRL guideline³, Table 3, pg. 12 and Table 4, pg. 22).

Table C-1 – TRL testing description

TRL Level	Scale of Testing	Fidelity	Environment	Development
9	Full	Identical	Operational (Full Range)	System Operations
8	Full	Identical	Operational (Limited Range)	System Commissioning
7	Full	Similar	Relevant	Technology Demonstration
6	Engineering / Pilot Scale	Similar	Relevant	
5	Lab / Bench	Similar	Relevant	Technology Development
4	Lab	Pieces	Simulated	Feasibility Research
3	Lab	Pieces	Simulated	
2		Paper		
1		Paper		Basic Technology Research

It should be noted that NASA, DoD, and DOE have slightly different definitions for TRLs⁵. A description of TRLs from this reference⁵ is given in Table C-2 on the following page. The DOE-specific Technology Readiness Level Scale is given in Table C-3 on the following pages. In terms of assessing the specific TRL, Appendix F of the DOE guideline³ has worksheets that serve as the basis of a TRL decision for DOE/EM projects.

Application to Transformative Enabling Capabilities

For the sake of this report, each capability is assessed in term of its application towards a fusion power plant. That is, a TRL 9 would imply that the capability has been commissioned and is operating in full fusion power plant conditions. At the current state of fusion development, this means that almost all capabilities will have a ceiling of TRL 6. A TRL of 7 may be possible once ITER is operating. This is the definition that is taken by Tillack, et al⁴ and the definitions of TRLs (1 through 9) for the specific applications of “tritium control and confinement” as well as “plasma control” are expressed there.

References

1. J. Banke, 2010 “*Technology Readiness Levels Demystified*,”
https://www.nasa.gov/topics/aeronautics/features/trl_demystified.html
2. 2011 *United States, Department of Defense, “Technology Readiness Assessment (TRA) Guidance*,”
<http://www.acq.osd.mil/chieftechologist/publications/docs/TRA2011.pdf>
3. 2015 *DOE G 413.3-4A, “Technology Readiness Assessment Guide*,”
<https://www.directives.doe.gov/directives-documents/400-series/0413.3-EGuide-04-admchg1/@@images/file>
4. M. S. Tillack *et al.*, 2009 *Fusion Sci. Techn.* **50** 949
5. 2016 *GAO-16-410G, “Technology Readiness Assessment Guide: Best Practices for Evaluating the Readiness of Technology for Use in Acquisition Programs and Projects*,” <http://www.gao.gov/assets/680/679006.pdf>

Table C-2 – Definition of TRLs from Ref. 5

Technology readiness level (TRL)	Description
1 Basic principles observed and reported	Lowest level of technology readiness. Scientific research begins to be translated into applied research and development. Examples include paper studies of a technology's basic properties.
2 Technology concept and/or application formulated	Invention begins. Once basic principles are observed, practical applications can be invented. Applications are speculative, and there may be no proof or detailed analysis to support the assumptions. Examples are limited to analytic studies.
3 Analytical and experimental critical function and/or characteristic proof of concept	Active research and development is initiated. This includes analytical studies and laboratory studies to physically validate the analytical predictions of separate elements of the technology. Examples include components that are not yet integrated or representative.
4 Component and/or breadboard validation in laboratory environment	Basic technological components are integrated to establish that they will work together. This is relatively low fidelity compared with the eventual system. Examples include integration of ad hoc hardware in the laboratory.
5 Component and/or breadboard validation in relevant environment	Fidelity of breadboard technology increases significantly. The basic technological components are integrated with reasonably realistic supporting elements so they can be tested in a simulated environment. Examples include high fidelity laboratory integration of components.
6 System/subsystem model or prototype demonstration in a relevant environment	Representative model or prototype system, which is well beyond that of TRL 5, is tested in its relevant environment. Represents a major step up in a technology's demonstrated readiness. Examples include testing a prototype in a high-fidelity laboratory environment or in a simulated operational environment.
7 System prototype demonstration in an operational environment	Prototype near or at planned operational system. Represents a major step up from TRL 6 by requirement demonstration of an actual system prototype in an operational environment (e.g., in an aircraft, a vehicle, or space).
8 Actual system completed and qualified through test and demonstration	Technology has been proven to work in its final form and under expected conditions. In almost all cases, this TRL represents the end of true system development. Examples include developmental test and evaluation of the system in its intended weapon system to determine if it meets design specifications.
9 Actual system proven through successful mission operations	Actual application of the technology in its final form and under mission conditions, such as those encountered in operational test and evaluation. Examples include using the system under operational mission conditions.

Table C-3 – DOE Technology Readiness Level Scale (Ref. 3, pg. 22)

Relative Level of Technology Development	Technology Readiness Level	TRL Definition	Description
System Operations	TRL 9	Actual system operated over the full range of expected conditions.	Actual operation of the technology in its final form, under the full range of operating conditions. Examples include using the actual system with the full range of wastes.
System Commissioning	TRL 8	Actual system completed and qualified through test and demonstration.	Technology has been proven to work in its final form and under expected conditions. In almost all cases, this TRL represents the end of true system development. Examples include developmental testing and evaluation of the system with real waste in hot commissioning.
	TRL 7	Full-scale, similar (prototypical) system demonstrated in a relevant environment.	Prototype full scale system. Represents a major step up from TRL 6, requiring demonstration of an actual system prototype in a relevant environment. Examples include testing the prototype in the field with a range of simulants and/or real waste and cold commissioning.
Technology Demonstration	TRL 6	Engineering/pilot-scale, similar (prototypical) system validation in a relevant environment.	Representative engineering scale model or prototype system, which is well beyond the lab scale tested for TRL 5, is tested in a relevant environment. Represents a major step up in a technology's demonstrated readiness. Examples include testing a prototype with real waste and a range of simulants.
Technology Development	TRL 5	Laboratory scale, similar system validation in relevant environment	The basic technological components are integrated so that the system configuration is similar to (matches) the final application in almost all respects. Examples include testing a high-fidelity system in a simulated environment and/or with a range of real waste and simulants.
	TRL 4	Component and/or system validation in laboratory environment	Basic technological components are integrated to establish that the pieces will work together. This is relatively "low fidelity" compared with the eventual system. Examples include integration of "ad hoc" hardware in a laboratory and testing with a range of simulants.
Research to Prove Feasibility	TRL 3	Analytical and experimental critical function and/or characteristic proof of concept	Active research and development is initiated. This includes analytical studies and laboratory scale studies to physically validate the analytical predictions of separate elements of the technology. Examples include components that are not yet integrated or representative. Components may be tested with simulants.
	TRL 2	Technology concept and/or application formulated	Invention begins. Once basic principles are observed, practical applications can be invented. Applications are speculative, and there may be no proof or detailed analysis to support the assumptions. Examples are still limited to analytic studies.
Basic Technology Research	TRL 1	Basic principles observed and reported	Lowest level of technology readiness. Scientific research begins to be translated into applied research and development (R&D). Examples might include paper studies of a technology's basic properties.

7. Appendix D - Letter to call for Community Input

Invitation and Guidance for Community Input FESAC Transformative Enabling Capabilities (TEC) Subcommittee 4/21/17

Executive Summary

The Fusion Energy Sciences Advisory Committee (FESAC) Transformative Enabling Capabilities (TEC) subcommittee welcomes the submission of white papers and talk requests (see below) that describe concepts and technologies that can bring fusion power closer to reality.

For full impact, all talk requests should be accompanied by white papers. While we recommend that all white papers be accompanied by talk requests, white papers will be considered in the absence of a companion talk. Every effort will be made to honor all talk requests responsive to the charge, subject to practical time constraints.

Background

The FESAC was recently charged *"to identify the most promising transformative enabling capabilities for the U.S. to pursue that could promote efficient advance toward fusion energy, building on burning plasma science and technology."*

The charge lists sample focus areas including *"liquid metals, additive manufacturing, high critical-temperature superconductors, exascale computing, materials by design, machine learning and artificial intelligence, and novel measurements."* Note that these are only examples. The committee will be accepting community input on any *"promising transformative enabling capabilities"* that promote efficient advance toward fusion energy associated with the subject matter being investigated by the TEC subcommittees listed below as designated by their titles. The full charge can be found at:

https://science.energy.gov/~media/fes/fesac/pdf/2017/Charge_Letter_FESAC_Feb_2017.pdf

Note that this activity is an assessment of (multiple) technical capabilities, and not an evaluation of confinement devices. According to the charge *"Identification of R&D that may have general impact that both includes and extends beyond"* tokamak and stellarator concepts *"is welcome. However an assessment of various types of confinement devices is not to be performed."*

The TEC subcommittee (R. Maingi, Chair, and A. Lumsdaine, Vice-Chair, full membership listed in Appendix 1) has been broken up into three sub-panels corresponding to different areas of technology application:

- Plasma Diagnostics, Actuators, and Control (lead: A. White)
- Plasma Materials Interaction (lead: J.P. Allain)
- Reactor and Balance of Plant (lead: C. Greenfield)

Community Input Meetings

In order to facilitate broad input, three meetings where the community can present to the FESAC subcommittee are planned:

- **May 30-June 1, 2017 (Washington DC area):** Community input meeting for Plasma Diagnostics, Actuators, and Control sub-panel, and also for Reactor and Balance of Plant sub-panel; workshop starts at 9 AM on 5/30 and ends by 6 PM on 6/1.

- **June 20-22, 2017 (Chicago or Washington DC area):** Community input meeting for Plasma-Materials Interaction sub-panel; workshop starts at 1 PM on 6/20 and ends by 6 PM on 6/22.
- **July 19-21, 2017 (PPPL, Princeton NJ):** Final workshop for all three sub-panels; additional community input time, if necessary; workshop starts at 1 PM on 7/19 and ends by 6 PM on 7/21.

Details on the locations for these workshops will be forthcoming in the next few weeks. All presenters are strongly encouraged to attend one of the first two workshops.

White paper and talk request submission details and guidelines

White papers should be submitted to the FESAC TEC home page at the following web site:

<https://www.burningplasma.org/activities/?article=FESAC%20TEC%20Panel%20Public%20Info%20Home%20Page> with cc to the Chair (Rajesh Maingi, rmaingi@pppl.gov) and the Vice-Chair (Arnold Lumsdaine, lumsdainea@ornl.gov) **by May 16 for the May 30 meeting, and by June 6 for the June 20 meeting.**

Talk requests with prospective titles should be submitted to rmaingi@pppl.gov and lumsdainea@ornl.gov at the earliest convenience, **but no later than May 16 for the May 30 meeting, and by June 6 for the June 20 meeting.** It is assumed that all talk requests will be followed up with white paper submissions. Any talk requests not accommodated in the first two meetings will be considered for the third meeting, July 19-21. Final talks should be submitted to the same BPO website above, using the proper radio button link, with cc to the Chair (Rajesh Maingi, rmaingi@pppl.gov) and the Vice-Chair (Arnold Lumsdaine, lumsdainea@ornl.gov). *Please use the naming convention <author>_FESAC_TEC2017_<paper or talk>.pdf.*

White papers are limited to 4 pages, and should include the components listed below. We will attempt to accommodate all requests for presentations that are responsive to our charge, subject to our time constraints. Our intention is to plan for a 15 minute talk with 15 minutes of Q/A from the FESAC subcommittee, but these may be shortened in order to provide additional presentation slots. If there are more requests than we can accommodate, even with shorter time slots, they will be accepted on a first-come, first-served basis. Please use the white paper template, linked to the FESAC TEC home page above, as a guideline, noting that not all questions will be relevant for all proposed technologies.

1. Description of the technology
2. Application of the technology for fusion energy, e.g. in a fusion power plant
3. Expected performance of the technology – what is the critical variable (or variables) that determines or controls the output of the technology?
4. Design variables – what are the parameters that can be controlled in order to optimize the performance of the technology?
5. Risks and uncertainties with the technology development and performance
6. Current maturity of the technology, using e.g. Technical Readiness Levels (TRL – see Appendix 2 for DoE TRL guidelines)
7. Required development for the technology

Initially, white papers will only be reviewed by the subcommittee and not publically available. White papers will later be posted on the web site, if permission is granted by the primary authors. Please address questions to Rajesh Maingi (rmaingi@pppl.gov) or Arnie Lumsdaine (lumsdainea@ornl.gov).

FESAC TEC white papers guidance and template - 4/17/17

Title for New Technology

I.M. Expert¹, C.S. Techie², U.R. Supporter²

¹Institution #1

²Institution #2

Email: IMexpert@myuniversity.edu

The white paper is limited to four pages (8.5x11 inch page with 1 inch margin, no smaller than 11 point font, Times New Roman or equivalent recommended), exclusive of references. The white paper should address the points listed below. Each of these major points should be addressed, but how each point is specifically addressed will vary depending on the technology, and may not match the specific questions.

1. Technology to be assessed
2. Application of the technology (note – while the application presented may be useful for a variety of different machines, it must be applicable to a tokamak or stellarator concept).
3. Critical variable(s) – variable that determines or controls the output of the technology
 - What is the goal for transformative technology – anticipated value or range of values for critical variable that needs to be achieved?
 - What is the range that is achievable for current state of technology?
4. Design variables – parameters that can be controlled in order to optimize the critical variable. These could be qualitative.
 - Give a description of values that are currently achievable, and a description of what needs to be explored in order to achieve transformation.
5. Risks and uncertainties
 - What are the inherent constraints on the technology (such as, limits that are based on physical laws)? What are the uncertainties in the calculations of steps 3 & 4?
 - What are the engineering questions and issues (manufacturability, go / no go issues, etc.). Are there any inherent safety issues?
 - Are there institutional, regulatory, or societal obstacles to the development or use of this technology? Is there resistance to the use of this technology in the scientific community, or in the relevant industries?
6. Maturity
 - What is the current technical readiness level for the application? What progress has been made in this technology in the last 20 years and what is the projected development rate?
7. Technology development for fusion applications
 - How many simultaneous innovations are required for this technology to achieve the goal? What is required to bring this technology to TRL3 or TRL6?
 - What is the time horizon for this technology to achieve the goal for the application?
 - What resources, public and private, are currently available to develop this technology? Will developments in this technology from other sources be useful for the requirements of the application?
 - (How) are other nations, through government or private sources, developing this technology? Are there gaps in global development that represent possible opportunity for US investment?

7. Appendix E - List of White Papers Submitted

<https://www.burningplasma.org/activities/?article=FESAC%20TEC%20White%20Papers>

First Author	Institution	Title
T.M. Biewer	ORNL	In-situ, Real-Time Measurement of Plasma Facing Component Erosion using Digital Holography
Rejean Boivin	GA	DIAGNOSTIC ENHANCEMENTS FOR FUSION DEVELOPMENT
Dan Brunner	MIT	Developing a reactor power exhaust solution by testing advanced divertors in a compact, divertor test tokamak
Patrick Calderoni	INL	Extraction of tritium from lithium based liquid metals
C.S. Chang	PPPL	Exascale computing as a transformative enabling technology for more efficient advance toward fusion energy reactor
Xi Chen	GA	TOP LAUNCH ECCD ENABLING HIGHER OFF-AXIS CURRENT DRIVE FOR STEADY-STATE OPERATION OF BURNING PLASMA TOKAMAKS
R.M. Churchill	PPPL	Accelerating fusion science with an end-to-end analysis framework for remote, large-scale, near real-time analysis
Ryan Dehoff	ORNL	Advanced Manufacturing – A Transformative Enabling Capability for Advancing Fusion
Luis F. Delgado-Aparicio	PPPL	Burning-plasma diagnostics: photon and particle detector development needs
Nicholas Eidietis	GA	TECHNOLOGY TO PRODUCE ROTATION IN REACTOR SYSTEMS
Nicholas Eidietis	GA	TRANSFORMATIVE DISRUPTION AVOIDANCE/MITIGATION SOLUTIONS
Osman El-Atwani	LANL	Advanced Material Design for Fusion Applications
Laila El-Guebaly	UW-Madison	Integral Management Strategy for Fusion Radwaste: Avoiding Geologic Disposal Through Recycling and Clearance
Laila El-Guebaly	UW-Madison	Neutronics and Tritium Breeding Capability for Liquid Metal-Based Blanket (DCLL)
Charles Forsberg	MIT	Flibe (6Li2BeF4) Blankets to Integrate Heat Production with Electricity Markets Using Nuclear Brayton Combined Cycles
Jeffrey Freidberg	MIT	High Field - The Path Forward for Tokamaks
Brenda L. Garcia-Diaz	Savannah River National Laboratory	Direct LiT Electrolysis in Molten Lithium
R. Granetz	MIT	Machine learning methods applied to disruption prediction
Houyang Guo	GA	DEVELOPMENT OF ADVANCED DIVERTOR CONCEPTS FOR STEADY-STATE TOKAMAKS

Charles Henager	PNNL	Plasma-Facing Materials by Design and Rapid Prototyping via Additive Manufacturing
M.A. Jaworski	PPPL	Slowly flowing and high temperature liquid metals as plasma-facing materials
Quanxi Jia	Buffalo	High Temperature Superconducting Wires with much Enhanced Current Carrying Capability for Fusion Magnets.
Yutai Katoh	ORNL	Advanced Manufacturing for Fusion PFC and Blanket Materials
Yutai Katoh	ORNL	Emerging High Temperature Materials for Potential Application to Fusion
Jim Klein	Savannah River National Laboratory	Tritium Fuel Cycle Technology Development
Egemen Kolemen	Princeton U.	Fast Liquid Metal Program for Fusion Reactor Divertor
Egemen Kolemen	Princeton U.	Real-time Stability Analysis and Control for Disruption Free Operations
B. LaBombard	MIT	Long-leg divertors with secondary x-points: a potential solution for divertor heat flux and PMI challenges -- aided by the development of demountable HTS magnets
Lang Lao	GA	EXTREME-SCALE COMPUTING WITH EMPHASIS ON HIGH-FIDELITY PHYSICS LEADING TO REDUCED MODELS FOR PLASMA SIMULATION AND CONTROL TECHNOLOGY
George Larsen	Savannah River National Laboratory	Low Energy Water Detritiation Technology
N.C. Luhmann, Jr.	UC-Davis	Harsh Environment Microwave Diagnostics for Reactor Plasmas
Robert Lunsford	PPPL	Fiber-Coupled Multiwavelength Raman Spectroscopy for in-situ examination and diagnosis of plasma facing components
Dick Majeski	PPPL	Mitigation of scrape-off layer power flow with lithium plasma-facing surfaces - Revised
Dick Majeski	PPPL	Recycling reduction for control of anomalous transport
Joe Minervini	MIT	Fusion Magnets using High Temperature Superconductors
Nygren, Richard E	Sandia National Laboratories	Advancing Fusion Power -- Smart Tiles and Fast Data
Richard E. Nygren	Sandia National Laboratories	Development of Fusion Sub-components with Additive Manufacturing
Nygren, Richard E	Sandia National Laboratories	High Impact on Fusion - Multiple Transformative Enabling Capabilities
Robert Pinsky	GA	HELICONS FOR CORE CURRENT DRIVE FOR REACTORS

Roger Raman	University of Washington	Development of a Fast Time Response Electromagnetic DM System
Roger Raman	University of Washington	Development of a Transient Coaxial Helicity Injection for Solenoid-free Plasma Start-up and Subsequent Non-inductive Sustainment
Roger Raman	University of Washington	Momentum Injection and Precise Core Fueling for Reactor Grade Plasmas
Lisa M. Reusch	UW-Madison	Developing Integrated Data Analysis techniques to optimize diagnostics for burning plasmas
P. Rodriguez-Fernandez	MIT	Accelerated Validation of Quasilinear Transport Codes via Machine Learning Strategies
Carlos A. Romero-Talamas	Maryland	Additive Manufacturing of Plasma Diagnostics: Opportunities and Challenges of a New Paradigm in Experimental Plasma Science
David N. Ruzic	UIUC	Liquid - Lithium as a Plasma Facing Material for Fusion Reactors
Alexander Scheinker	LANL	Adaptive Feedback Control for Automated Plasma Diagnostics and Control Systems
Thomas Schenkel	LBNL	Accessing the multi-scale and time-resolved dynamics of radiation-induced defects in materials in support of PMI research for fusion
Eugenio Schuster	Leigh	Reactor-like Control Integration by Model-based Real-time Optimization
Peter Seidl	LBNL	High power multi-beamlet RF linear ion accelerators for neutral beam injection and plasma heating
Masashi Shimada	INL	Superpermeable Metal Foil Pump for Increasing Tritium Burn-Up Fraction for DEMO
Sterling Smith	GA	SPIN-POLARIZED FUEL TO INCREASE FUSION GAIN
Sergey Smolentsev	UCLA	Computational predictive capability for multi-physics, multi-effect MHD flows, heat & mass transfer in LM fusion cooling applications
Brandon Sorbom	MIT	Demountable Superconducting Magnet Coils
Derek A. Sutherland	UW-Madison	Steady, inductive helicity injection for efficient sustainment of stable toroidal plasmas
Mark Tillack	GA	ACCELERATED DEPLOYMENT OF SILICON CARBIDE COMPOSITES FOR AN ATTRACTIVE FUSION ENERGY SOURCE
Mark Tillack	GA	AN INTEGRATED APPROACH TO PLASMA-FACING COMPONENT SYSTEMS DEVELOPMENT FOR FUSION NUCLEAR DEVICES
Kurt Vetter	ORNL	Radiation Hardening of Electronics and Instruments for Fusion
Xiaorong Wang	LBL	REBCO magnet technology to enable next-generation magnetic-confinement fusion machines
Yinmin (Morris) Wang	LLNL	Laser powder-bed-fusion additive manufacturing as a transformative technology for plasma-facing materials and components
Yongqiang Wang	LANL	New Irradiation Capabilities for Fusion Materials R&D

Brian Williams	Ultramet	Robust Cellular Solid Breeder Offering Potential for New Blanket Designs with High Tritium Breeding Ratio
Brian Williams	Ultramet	Self-Healing Liquid Metal Protection System for Plasma-Facing Components
Brian Williams	Ultramet	Ultrahigh Heat Flux Helium-Cooled Divertor Incorporating a Foam Core Heat Exchanger
Stephen J Wukitch	MIT	Path towards RF Sustainment of Steady State Fusion Reactor Plasmas
Dennis Youchison	ORNL	Advanced Cooling Technologies through Additive Manufacturing
Yuhu Zhai	PPPL	High Temperature Superconducting Magnets for Next Step Fusion Reactor

7. Appendix F - Agendas for Community Input Workshops

FESAC TEC Agenda, Rockville MD, Tuesday, 5/30/17

Room: Plaza 1 & 2

<https://www.burningplasma.org/activities/?article=FESAC%20TEC%20Panel%20Public%20Info%20Home%20Page>

AGENDA DRAFT V. 5/23/17

Registration and badges	8:15
R. Maingi, A. Lumsdaine, S. Barish – Welcome, charge, logistics	8:45
A. White, C. Greenfield – Remarks from subpanel leads	9:05
J. Kelly (Invited – special topic) – Generation IV fission reactor technologies	9:15
L. El-Guebaly (Invited) – Neutronics and Tritium Breeding Capability for Liquid Metal-Based Blanket (DCLL)	10:15
<i>Coffee break</i>	11:00
C. Forsberg – Flibe (6Li2BeF4) Blankets to Integrate Heat Production with Electricity Markets Using Nuclear Brayton Combined Cycles	11:30
<i>Lunch</i>	12:00
C. Romero-Talamas (Invited) – Additive manufacturing of plasma diagnostics	1:30
R. Majeski – Recycling reduction for control of anomalous transport	2:15
T. Biewer – In-situ, real-time measurement of plasma facing component erosion using digital holography	2:45
L. Delgado-Aparicio – Burning-plasma diagnostics: photon and particle detector development needs	3:15
<i>Coffee break</i>	3:45
J. Minervini – Fusion Magnets using High Temperature Superconductors	4:00
Y. Zhai – High Temperature Superconductors for next step fusion magnets	4:30
B. Sorbom – Demountable Superconducting Magnet Coils	5:00
J. Freidberg (D. Whyte) – High Field – The Path Forward for Tokamaks	5:30
<i>Adjourn</i>	6:00

FESAC TEC Agenda, Rockville MD, Wednesday, 5/31/17

Room: Plaza 1 & 2

<https://www.burningplasma.org/activities/?article=FESAC%20TEC%20Panel%20Public%20Info%20Home%20Page>

AGENDA DRAFT V. 5/23/17

- X. Wang – REBCO magnet technology to enable next-generation magnetic-confinement fusion machines **9:00**
- J. Schneider (**Invited**) – Machine learning, artificial intelligence and robotic reasoning **9:30**
- A. Flatau – Overview of state-of-the-art smart materials for sensing and actuation **10:15**
- Coffee break* **10:45**
- M. Tillack (L. Holland or TBD) – Accelerated Deployment of Silicon Carbide Composites for an Attractive Fusion Energy Source **11:15**
- X. Chen, R. Pinsker (M. Wade) – Next-generation current-drive systems **11:45**
- Lunch* **12:15**
- D. Sutherland – Steady, inductive helicity injection for efficient sustainment of stable toroidal plasmas **1:45**
- N. Eidietis – Technology to Produce Rotation in Reactor Systems **2:15**
- P. Seidl – High power multi-beamlet RF linear ion accelerators for neutral beam injection and plasma heating **2:45**
- E. Schuster – Reactor-like Control Integration by Model-based Real-time Optimization **3:15**
- Coffee break* **3:45**
- N. Eidietis – Transformative Disruption Avoidance/Mitigation solutions **4:00**
- E. Kolemen – Real-time Stability Analysis and Control for Disruption Free Operations **4:30**
- L. Lao – Extreme-Scale Computing with Emphasis on High-Fidelity Physics Leading to Reduced Models for Plasma Simulation and Control Technology **5:00**
- S. Smith (M. Wade) – Spin Polarized Fuel to Advance Magnetic Fusion Performance **5:30**
- Adjourn* **6:00**

FESAC TEC Agenda, Rockville MD, Thursday, 6/1/17

Room: Plaza 1 & 2

<https://www.burningplasma.org/activities/?article=FESAC%20TEC%20Panel%20Public%20Info%20Home%20Page>

AGENDA DRAFT V. 5/23/17

S. Reyes (Invited) – Tritium safety	9:00
L. Reusch (D. denHartog) – Developing Integrated Data Analysis techniques to optimize diagnostics for burning plasmas (Remote – 1 hour)	9:45
A. Scheinker – Adaptive Feedback Control for Automated Plasma Diagnostics and Control Systems (Remote – 2 hours)	10:15
<i>Coffee break</i>	10:45
R. Boivin – Diagnostic Enhancements for Fusion Development (Remote – 3 hours)	11:15
B. Williams – Robust Cellular Solid Breeder Offering Potential for New Blanket Designs with High Tritium Breeding Ratio (Remote – 3 hours)	11:45
<i>Lunch</i>	12:15
Panel Executive Session (closed door)	1:45
<i>Adjourn</i>	5:00

FESAC TEC Agenda, Chicago, IL, Tuesday, 6/20/17

Room: Sheraton 1

<https://www.burningplasma.org/activities/?article=FESAC%20TEC%20Panel%20Public%20Info%20Home%20Page>

REMOTE CONNECTION INFORMATION BELOW

Panel Executive Session	1:00
Registration and badges	1:30
R. Maingi, A. Lumsdaine, S. Barish, J.P. Allain – Welcome, charge, logistics	2:00
P. Seidl (Invited) – Accessing the multi-scale and time-resolved dynamics of radiation-induced defects in materials in support of PMI research for fusion	2:20
Y. Wang – New Irradiation Capabilities for Fusion Materials R&D	3:00
D. Ruzic – The Case for a Liquid Lithium-Surface Divertor	3:30
<i>Coffee break</i>	4:00
M. Jaworski – Use of slowly-flowing, liquid lithium targets as a transformative technology to enable fusion energy	4:30
D. Majeski – Mitigation of scrape-off layer power flow with lithium plasma-facing surfaces	5:00
E. Kolemen – Fast Flowing Liquid Metal Technology for Fusion Reactor Divertor	5:30
B. Williams (remote) – Self-Healing Liquid Metal Protection System for Plasma-Facing Components	6:00
<i>Adjourn</i>	6:30

Remote Connection Information

Join from PC, Mac, Linux, iOS or Android: <https://zoom.us/j/5356199734>

Or iPhone one-tap (US Toll): +14086380968,5356199734# or +16465588656,5356199734#

Or Telephone:

Dial: +1 408 638 0968 (US Toll) or +1 646 558 8656 (US Toll)

Meeting ID: 535 619 9734

International numbers available: <https://zoom.us/join?m=PKzuM-ZI8yypCUu0b0B46hRtXdL77UL7>

Or an H.323/SIP room system:

162.255.37.11 (US West)

162.255.36.11 (US East)

Meeting ID: 535 619 9734

FESAC TEC Agenda, Chicago, IL, Wednesday, 6/21/17

Room: Sheraton 1

<https://www.burningplasma.org/activities/?article=FESAC%20TEC%20Panel%20Public%20Info%20Home%20Page>

R. Dehoff (Invited) – Additive Manufacturing	9:00
M. Wang (Invited) – Additive Manufacturing	9:40
Y. Katoh – Advanced Manufacturing for Fusion PFC and Blanket Materials	10:20
<i>Coffee break</i>	10:50
C. Henager – Plasma-Facing Materials by Design and Rapid Prototyping via Additive Manufacturing	11:20
R. Nygren – Additive Manufacturing	11:50
<i>Lunch</i>	12:20
D. Youchison (remote) – Advanced cooling technologies through additive manufacturing	1:50
Q. Jia (Invited) – Fabrication of high temperature superconducting wires with desired current carrying capability for fusion magnets	2:20
E. Martinez – Advanced Materials Design for Fusion Applications	3:00
<i>Coffee break</i>	3:30
Y. Katoh – Emerging high temperature materials for potential application to fusion	4:00
B. Williams (remote) – Ultrahigh Heat Flux Helium-Cooled Divertor Incorporating a Foam Core Heat Exchanger	4:30
B. Uberuaga (invited) – Computational materials modeling	5:00
<i>Adjourn</i>	6:00

FESAC TEC Agenda, Chicago, IL, Thursday, 6/2/17

Room: Sheraton 1

<https://www.burningplasma.org/activities/?article=FESAC%20TEC%20Panel%20Public%20Info%20Home%20Page>

B. LaBombard – Long-leg divertors with secondary x-points: a potential solution for divertor heat flux and PMI challenges - aided by the development of demountable HTS magnets	9:00
H.Y. Guo – Development of Advanced Divertor Concepts for Steady-State Advanced Tokamaks	9:30
D. Brunner – Developing a reactor power exhaust solution by testing advanced divertors in a compact, divertor test tokamak	10:00
<i>Coffee break</i>	10:30
S. Malloy (Invited) – Development of Radiation tolerant Ferritic Steels for Fusion Applications	11:00
<i>Lunch</i>	11:40
Panel Executive Session (closed door)	1:00
<i>Adjourn</i>	4:00

FESAC TEC Agenda, Princeton NJ, Wednesday, 7/19/17

Room: MBG Auditorium

<https://www.burningplasma.org/activities/?article=FESAC%20TEC%20Panel%20Public%20Info%20Home%20Page>

REMOTE CONNECTION INFORMATION BELOW

Panel Executive Session	12:30
R. Maingi, A. Lumsdaine, T. Brog (PPPL Director) – Welcome, logistics	1:00
D. Hazelton – HTS, Industry Perspective	1:15
P. Lee – High Tc superconductor	2:00
<i>Coffee break & Group Photo</i>	2:45
J. Sarrao – Materials by design, harsh environments	3:00
J. Moore (remote) – Self-healing materials	3:45
J. Hittinger – Advanced algorithms	4:30
P. Bonoli – Exascale computing	5:15
C. Wong – Different blanket options	6:00
<i>Adjourn</i>	6:45
Panel no-host dinner, site TBD	7:30

Remote Connection Information for public talks in MBG Auditorium

Join from PC, Mac, Linux, iOS or Android: <https://zoom.us/j/5356199734>

Or iPhone one-tap (US Toll): +14086380968,5356199734# or
+16465588656,5356199734#

Or Telephone:

Dial: +1 408 638 0968 (US Toll) or +1 646 558 8656 (US Toll)

Meeting ID: 535 619 9734

International numbers available: <https://zoom.us/join?m=PKzuM-ZI8yZpCUu0b0B46hRtXdL77UL7>

Or an H.323/SIP room system:

162.255.37.11 (US West)

162.255.36.11 (US East)

Meeting ID: 535 619 9734

FESAC TEC Agenda, Princeton NJ, Thursday, 7/20/17
Room: MBG Auditorium

Panel Executive Session	8:00
B. Garcia-Diaz – Tritium extraction from lithium	8:15
K. Vetter – Radiation hardened electronics	9:00
G. Rochau – Advanced energy conversion techniques	9:45
<i>Coffee break</i>	10:30

Remote Connection Information for public talks in MBG Auditorium

Join from PC, Mac, Linux, iOS or Android: <https://zoom.us/j/5356199734>

Or iPhone one-tap (US Toll): +14086380968,5356199734# or
+16465588656,5356199734#

Or Telephone:

Dial: +1 408 638 0968 (US Toll) or +1 646 558 8656 (US Toll)

Meeting ID: 535 619 9734

International numbers available: <https://zoom.us/join?m=PKzuM-ZI8yZpCUu0b0B46hRtXdL77UL7>

Or an H.323/SIP room system:

162.255.37.11 (US West)

162.255.36.11 (US East)

Meeting ID: 535 619 9734

Parallel sessions – White subpanel (MBG auditorium) <https://zoom.us/j/5356199734>

R. Raman – Fast Time Response Disruption Mitigation for Tokamaks **11:00**

S. Wukitch – Path towards RF Sustainment of SS Fusion Reactor Plasmas **11:30**

Parallel sessions – Allain subpanel (Dir. Conf. Room) <https://zoom.us/j/7256959020>

D. Stotler & D. Curreli – Advanced modeling **11:00**

L. Holland – An integrated approach to PFC systems development for fusion nuclear devices **11:30**

Parallel sessions – Greenfield subpanel (B252) <https://zoom.us/j/4729286588>

M. Shimada – Superpermeable Metal Foil Pump for Increasing Tritium Burn-Up Fraction for DEMO **11:00**

L. El-Guebaly – Integral Management Strategy for Fusion Radwaste: Avoiding Geologic Disposal Through Recycling and Clearance **11:30**

Lunch **12:00**

Panel-wide discussion on what is a TEC element	1:00
White subpanel to present TEC elements - Director's Conference Room	1:30
<i>Coffee available</i>	2:00
Panel Parallel Sessions (closed door)	4:30
<ul style="list-style-type: none"> • White – Director's Conference Room • Allain – MBG Auditorium • Greenfield – B252 	
Flexible dinner plans, depending on subpanel needs	8:00
FESAC TEC Agenda, Princeton NJ, Friday, 7/21/17 – B318 (closed door)	
Allain subpanel to present TEC elements	8:00
<i>Coffee available</i>	10:00
Greenfield subpanel to present TEC elements	11:00
<i>Working Lunch</i>	12:00
Discussion of TEC elements where there is no clear consensus	2:00
<i>Coffee available</i>	2:00
Writing assignments and planning for Sept. 6 meeting	3:30
<i>Adjourn</i>	4:30

7. Appendix G– Glossary / List of Acronyms

AI	=	Artificial Intelligence
AM	=	Additive Manufacturing
ARIES-CS	=	Advanced Reactor Innovation and Evaluation Study - Compact Stellarator
BOP	=	Balance of Plant
BT3F	=	Blanket Thermomechanics Thermofluid Test Facility
CD	=	Current Drive
CERN	=	European Organization for Nuclear Research
CFETR	=	China Fusion Engineering Test Reactor
CNA	=	Castable Nanostructured Alloy
CORC™	=	Conductor on Round Core
CPU	=	Central Processing Unit
CT	=	Compact Toroid
DCLL	=	Dual Coolant Lead Lithium
DEMO	=	Demonstration Reactor
DIR	=	Direct Internal Recycling
dpa -	=	displacement per atom
EAST	=	Experimental Advanced Superconducting Tokamak
EBM	=	Electron Beam Melting
EBS	=	Electron Backscatter Diffraction
ECCD	=	Electron Cyclotron Current Drive
EERE	=	Energy Efficiency and Renewable Energy
ELM	=	Edge Localized Mode
ENEA	=	Italian National agency for new technologies
EPI	=	Electromagnetic Particle Injection
FCDF	=	Fuel Cycle Development Facility
FESAC	=	Fusion Energy Sciences Advisory Committee (FESAC)
FFHR	=	Force-Free Helical Reactor
FNSF	=	Fusion Nuclear Science Facility
FTU	=	Frascati Tokamak Upgrade
GPU	=	Graphics Processing Unit
HEA	=	High-Entropy Alloy
HFS	=	High-Field Side
HI	=	Helicity Injection
HICD	=	Helicity Injection Current Drive
HPC	=	High Performance Computing
HTS	=	High critical Temperature Superconductors
IDA	=	Integrated Data Analysis
ISS	=	Isotope Separation System
JET	=	Joint European Torus
JT-60SA	=	Japan Torus-60 Super Advanced
KSTAR	=	Korea Superconducting Tokamak Advanced Research
LFS	=	Low-Field Side
LH	=	Lower Hybrid
LM	=	Liquid Metal
LTS	=	Low Temperature Superconductor
MAX phase	=	hexagonal carbides and nitrides have the general formula: $M_{n+1}AX_n$

MELCOR	=	fully integrated, engineering-level computer code developed by Sandia National Laboratories
MFP	=	Metal Foil Pump
MGI	=	Massive Gas Injection
MHD	=	Magnetohydrodynamics
ML	=	Machine Learning
MRI	=	Magnetic resonance imaging
NABCC	=	Nuclear Air Brayton Combined Cycle
NBI	=	Neutral Beam Injection
NIFS	=	National Institute for Fusion Science
NMR	=	Nuclear Magnetic Resonance
OHEP	=	Office of High Energy Physics
PAV	=	Permeator Against Vacuum
PFC	=	Plasma Facing Component
PHTS	=	Primary Heat Transport System
PID	=	Proportional–Integral–Derivative
PMI	=	Plasma Material Interaction
RAFMS	=	Reduced Activation Ferritic Martensitic Steel
REBCO	=	Rare-Earth Barium Copper Oxide
RF	=	Radio Frequency
RISMC	=	Risk Informed Safety Margin Characterization
SBIR/STTR	=	Small Business Innovation Research / Small Business Technology Transfer
SLM	=	Selective Laser Melting
SOL	=	Scrape-Off-Layer
SPI	=	Shattered Pellet Injection
TBEF	=	Tritium Breeding and Extraction Facility
TBF	=	Tritium Burn Fraction
TBM	=	Test Blanket Module
TBR	=	Tritium Breeding Ratio
TCAP	=	Thermal Cycling Absorption Process
TEC	=	Transformative Enabling Capabilities
TF	=	Toroidal Field
TRL	=	Technology Readiness Level
TZM	=	Titanium Zirconium Molybdenum
UHTC	=	Ultra-High-Temperature Ceramics
UQ	=	Uncertainty Quantification
VV	=	vacuum vessel
W7X	=	Wendelstein 7-X
YBCO	=	Yttrium Barium Copper Oxide