

Please see committee and report information at: <https://www.nap.edu/25331>

*The National
Academies of* | SCIENCES
ENGINEERING
MEDICINE

Final Report of the Committee on a Strategic Plan for

BURNING PLASMA RESEARCH

Download the report at [nap.edu/25331](https://www.nap.edu/25331)

Michael Mauel and Melvyn Shochet, Co-Chairs
FESAC Briefing: March 13, 2019

#BurningPlasma

Outline

- Committee and its process
- Assessments in brief
- Two primary recommendations
- Report structure
- Extending the Frontier of Burning Plasma Research (*1st Main Rec*)
- Advancing Magnetic Fusion towards an Economical Energy Source (*2nd Main Rec*)
- Organizational Structure and Program Balance
- Comments on NAS Plasma Decadal and APS-DPP/FESAC Community Planning

Committee on a Strategic Plan for U.S. Burning Plasma Research

The Department of Energy requested two reports.

Interim Report (Dec 21, 2017) presented the committee's assessment of the **current status** of United States fusion research and of the **importance of burning plasma research** to the development of fusion energy as well as to plasma science and other science and engineering disciplines.

Final Report (Dec 12, 2018) provided guidance on a **strategic plan for a national program of burning plasma science and technology research** given the U.S. strategic interest in realizing economical fusion energy in the long-term. Strategic guidance provided in two scenarios, in which the United States is, or is not, a member in ITER.

(Full Statement of Task at: <https://www.nap.edu/25331>)

Committee's Study and Process

- **39 presentations from experts from around the world;** more than **100 scientific white papers.**
- Seven meetings, several teleconferences, and several working groups.
- **Visits to the major fusion research facilities** within the United States, toured the superconducting magnet facility at Poway, CA and the large ITER central solenoid magnets, heard from all international partners, and learned first-hand of the EU strategy during a visit to the ITER construction site.
- Heard about fusion energy strategy from the two largest **privately-funded fusion ventures within the United States:** Dr. Bob Mumgaard, Commonwealth Fusion Systems (CFS) and Dr. Michl Binderbauer, TAE Technologies.
- Two weeklong community **Workshops on Strategic Directions for U.S. Magnetic Fusion Research**, hosted by University of Wisconsin at Madison (July 2017) and University of Texas at Austin (December 2017).
- FESAC Report on ***Transformative Enabling Capabilities Toward Fusion Energy*** (February 2018); Rajesh Maingi (**FESAC**, chair) Arnie Lumsdaine (**FESAC**, co-chair)

This report describes several “*revolutionary*” ideas that would dramatically increase the rate of progress through increased performance, simplification, reduced cost or time to delivery, or improved reliability/safety.

Committee Membership

Michael Mael, Columbia University, Co-Chair

Melvyn Shochet (NAS), Univ Chicago, Co-Chair

Christina Back, General Atomics

Riccardo Betti, University of Rochester

Ian Chapman, UK Atomic Energy Authority

Cary Forest, University of Wisconsin, Madison

T. Kenneth Fowler (NAS), Univ of California, Berkeley

Jeffrey Freidberg, MIT

Ronald Gilgenbach, University of Michigan

William Heidbrink, University of California, Irvine

Mark Herrmann, LLNL

Frank Jenko, IPP Garching and University of Texas, Austin

Stanley Kaye, Princeton University

Mitsuru Kikuchi, Nat. Inst. Quantum Radiological Sci & Tech

Susana Reyes (FESAC), LCLS-II/SLAC

C. Paul Robinson (NAE), Advanced Reactor Concepts, LLC

Philip Snyder, General Atomics

Amy Wendt (FESAC), University of Wisconsin, Madison

Brian Wirth (FESAC), University of Tennessee, Knoxville

Chris Jones, David Lang, NRC Study Director

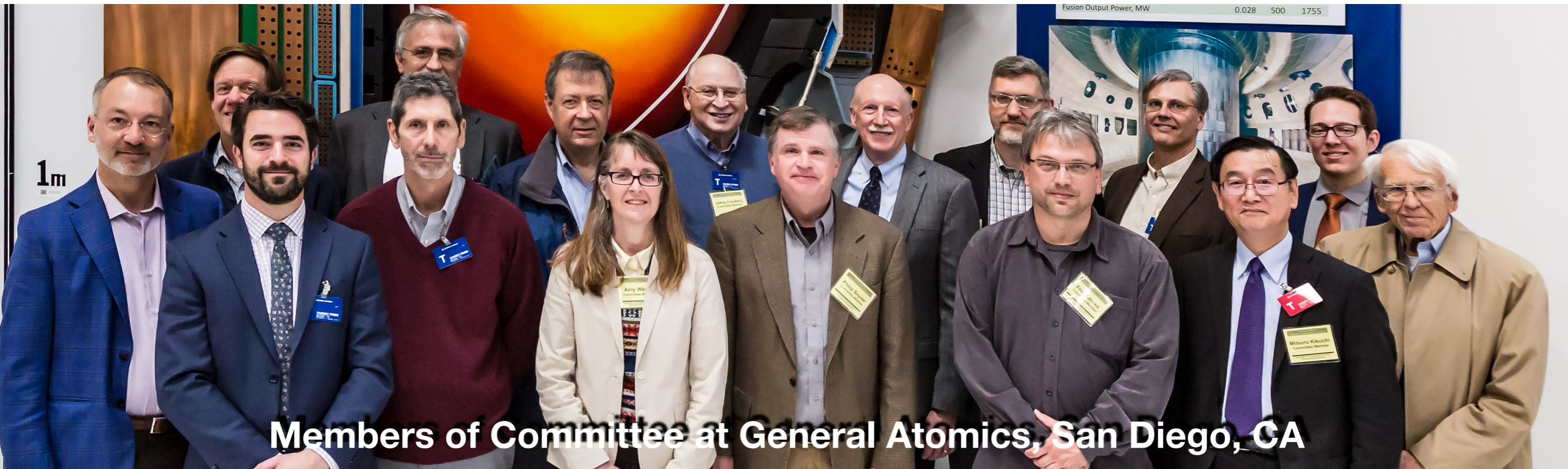

Members of Committee at General Atomics, San Diego, CA

Assessments of Scientific and Technical Status

- **(NAS BP 2004 Ch 3)** “progress in fusion science and fusion technology has led to confidence that the global fusion community is scientifically ready to take the burning plasma step”
- **(NAS BP 2018 Interim and Final Reports)** “significant progress in all important areas identified in the 2004 report”
 - **Burning plasma physics:** ELM control, 100% bootstrap, detachment/core radiation control, optimized pedestal, world-record pressure, enhanced performance ($H > 1$), ...
 - **Growth of International Effort:** ILW, great progress understanding the integrated S&T of “Core-Pedestal-SOL-Divertor”, sustained operation of large superconducting experiments (LHD, EAST, KSTAR, WEST, W-7X), ...
 - **Advancing Technology (FESAC TEC 2018):** High-field superconducting magnets, advanced manufacturing, intelligent control, novel T tech, industrial innovations, ...
 - **ITER Construction Progress:** “First-of-a-kind” construction license, 60% complete to first-plasma

Assessments of Strategic Planning

- Although our international partners have national strategic plans leading to a fusion energy demonstration device, **the United States does not.**
- If the U.S. wishes to maintain scientific and technical leadership in this field, **the U.S. needs to develop its own long-term strategic plan for fusion energy.** *The following elements are important:*
 - Continued progress towards the construction and operation of a burning plasma experiment leading to the study of burning plasma,
 - Research beyond what is done in a burning plasma experiment to improve and fully enable commercial fusion power,
 - Innovation in fusion science and technology targeted to improve the fusion power system as a commercial energy source, and
 - A mission for fusion energy research that engages the participation of universities, national laboratories, and industry in the realization of commercial fusion power for the nation.

Two Main Recommendations

The Committee's unanimous conclusion within its Final Report is ...

Now is the right time for the United States to develop plans to benefit from its investment in burning plasma research and take steps towards the development of fusion electricity for the nation's future energy needs.

The implementation of these plans should be guided by the committee's two main recommendations:

- *First, the United States should remain an ITER partner as the most cost-effective way to gain experience with a burning plasma at the scale of a power plant.*
- *Second, the United States should start a national program of accompanying research and technology leading to the construction of a compact pilot plant which produces electricity from fusion at the lowest-possible capital cost.*

Now is the right time...

This conclusion is based on: (i) significant progress in predicting and controlling high-pressure plasma, (ii) growth of the international and private sector research programs, (iii) ITER construction is more than half complete and confidence has improved, (iv) new technologies, such as high-field superconducting magnets, advanced manufacturing and new materials, make possible a less costly pathway to fusion electricity, and (v) *much more ...*

A national program of research and technology leading to the construction of a compact pilot plant at the lowest-possible capital cost **will engage universities, national laboratories, and industry in the realization of fusion power.**

In the near- and mid-terms, the U.S. program should resolve critical research needs for the construction of a compact fusion pilot plant:

- Understand the science, production, and control of a burning plasma with ITER,
- Demonstrate the science and engineering to sustain a magnetically confined plasma with the confinement and power-handling properties needed for a compact fusion pilot plant,
- Advance very high-field superconducting magnets for fusion,
- Expand research in fusion nuclear science, materials science, and tritium and blanket technologies needed to fully enable fusion electricity, and
- Promote promising innovations in burning plasma science and fusion engineering science.

Outline of Final Report

Front Matter

Preface

Executive Summary

- Chapter 1: Introduction
- Chapter 2: Progress in Burning Plasma Science and Technology
- Chapter 3: Extending the Frontier of Burning Plasma Research (*1st Main Rec*)
- Chapter 4: Advancing Magnetic Fusion towards an Economical Energy Source (*2nd Main Rec*)
- Chapter 5: Strategic Guidance for a National Program for Burning Plasma Science and Technology
- Chapter 6: Comments on Organizational Structure and Program Balance

Appendixes: Statement of Task; Interim Report, Summary of Process and Input, History of Strategic Planning, Notional Budget Implications, Bios; Acronyms

First Main Recommendation

The United States should remain an ITER partner as the most cost-effective way to gain experience with a burning plasma at the scale of a power plant.

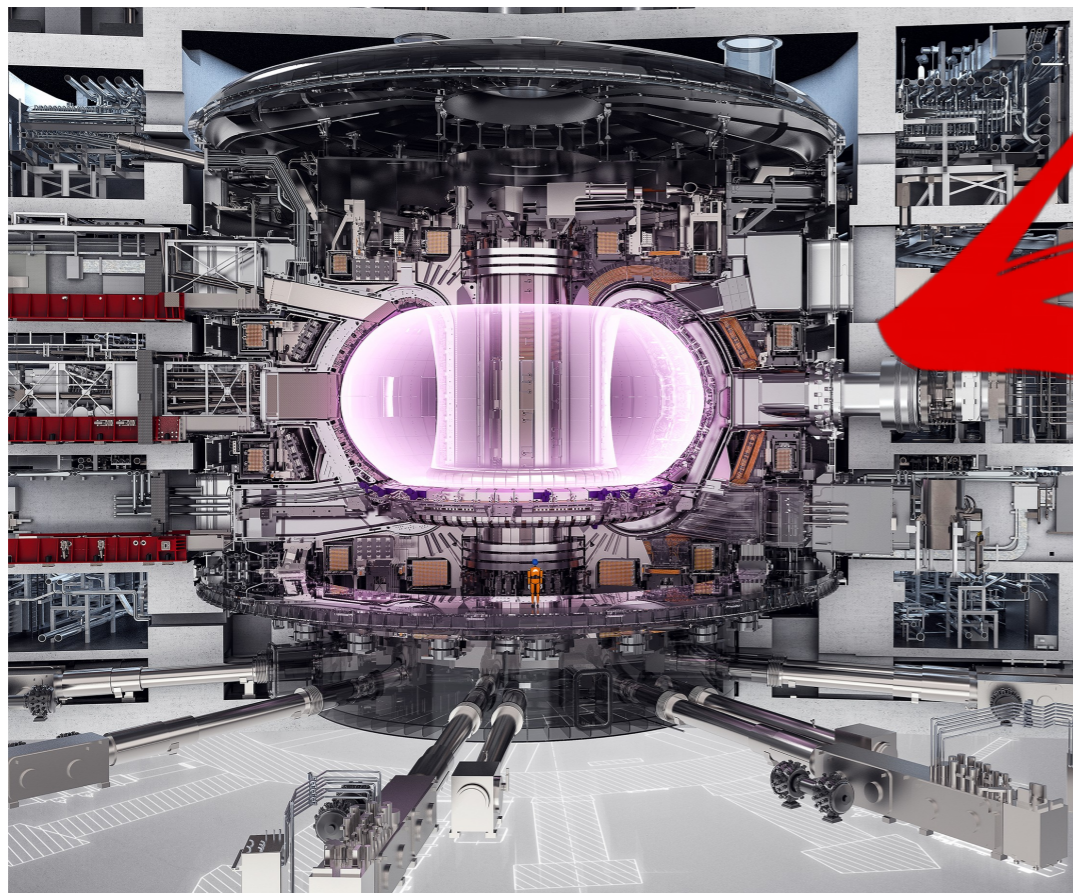

As the world's largest research facility, ITER will give scientists their first opportunity to create, study, and control a burning plasma.

ITER operation will be scientific and technical achievement, and experience with ITER is a critical step towards delivering electricity from fusion energy.

The Importance of Burning Plasma Research and ITER to the U.S. Program

Finding: The scientific and technical benefits from the study and operation of ITER are compelling and critical to the development fusion energy for the United States.

Recommendation: Because the scientific and technical benefits from ITER are compelling and because ITER is the only existing project to create a burning plasma at the scale of a power plant, **the Committee recommends that the United States government fulfill its commitment to construct and operate ITER as the primary experiment in the burning plasma component of its long-term strategic plan for fusion energy.**

Recommendation: A near-term focus of the U.S. DOE OFES research program should **maximize the scientific and technical benefits from its partnership in a burning plasma experiment.**

Extending ITER Performance

Finding: Advances in understanding toroidal magnetic confinement, plasma control, and integrated solutions to whole-plasma optimization point to improvements beyond the ITER baseline and show how careful design and simulation can be used to lower the cost and accelerate fusion energy development.

Recommendation: In the longer-term, the U.S. DOE OFES research program should encourage the **development and testing of burning plasma scenarios on ITER that contribute to reliable operation of a compact fusion pilot plant.**

Second Main Recommendation

The United States should start a national program of accompanying research and technology leading to the construction of a compact pilot plant which produces electricity from fusion at the lowest-possible capital cost.

A U.S. Fusion Pilot Plant:

- Produce fusion power similar to ITER **but in a device much smaller in size and cost** and employing design improvements to allow net electricity production.
- This compact fusion pilot plant would be a pre-commercial **research facility**.
- In addition to the production of fusion electricity, **it would be staged** and ultimately be capable of uninterrupted operation for weeks and produce tritium.
- **As a pilot plant, its purpose will be learning**, but the knowledge obtained would be sufficient to design the first commercial fusion power systems.

Second Main Recommendation

The United States should start a national program of accompanying research and technology leading to the construction of a compact pilot plant which produces electricity from fusion at the lowest-possible capital cost.

A U.S. Fusion Pilot Plant:

- A compact fusion pilot plant represents a **different pathway** as compared to those pursued by our international partners.
- The U.S. pilot plant targets **lowest possible capital cost** (not levelized C.O.E.) in order to reduce the cost of the development pathway.
- The U.S. pilot plant would be **smaller** than ITER; not a DEMO **larger** than ITER.
- The committee's recommended strategy **entails more risk than our international partners** because it requires research in parallel with ITER **aimed at improving and reducing the capital cost of fusion** through the development of promising innovations in burning plasma science, materials science, and fusion engineering science.

Second Main Recommendation

A new national focus on developing a compact pilot plant in the long term will help set priorities for the near and mid-term fusion program.

Research needs:

- Increase the fusion power density beyond that obtainable in ITER
- Demonstrate uninterrupted operation while also learning how to handle reliably the high levels of escaping heat from the plasma
- Immediately begin new program elements to develop the materials and technologies needed to extract the heat and recirculate tritium and, also, to promote the industrial development of very-high-field superconducting magnets for fusion.
- Finally, encourage the development of technology innovations to simplify maintenance and lower construction cost.

Second Main Recommendation

The committee recognizes that there are scientific and technical risks involved in developing a compact fusion pilot plant. Resolving these risks will necessitate research progress and the design and operation of new facilities.

Significant research challenges:

- The control of a continuous high-pressure compact plasma, which will require a design and construction of new intermediate-scale research facility in the United States, or a significant upgrade to an existing facility, to establish its feasibility.
- The qualification of the materials and components that surround the plasma and are exposed to fusion irradiation.

Question: What are the cost-effective research initiatives, programs, and facilities to achieve this research progress?

Chapter 6

Comments on Organizational Structure and Program Balance

- **Organizational Structure and Program Management**
 - Expanding the OFES Organization to Meet Program Needs
 - Adopting a Long-term Strategy Towards a Fusion Energy Goal
 - Strengthening Community Organization and Input
- **Further Strengthening of United States Fusion Research**
 - Setting Safety and Licensing Standards for Fusion Energy Research Facilities
 - Health of the U.S. Fusion Program
 - International Partnerships
 - Private Sector
 - Relationship Between Private Sector and National Goals
 - Linkages to Other Science and Technology Disciplines
 - Public outreach

Five **Findings** and seven **Recommendations** aimed to guide implementation of an expanded U.S. DOE/FES research program and strengthen community participation in burning plasma science, materials science, fusion nuclear science, and engineering science.

Organizational Structure and Program Balance

Recommendation: The committee recommends **a new division within U.S. DOE/FES** to manage and organize research in developing technologies needed to improve and fully enable the fusion power system.

Recommendation: The U.S. DOE/FES should establish a formal strategic planning process by which, at regular intervals, respected scientific and technical leaders review progress on short- and long-term goals. ... **Community input should be an essential element of this process.**

Recommendation: It is recommended that the **DOE Fusion Safety Standards** be reviewed for consistency with current regulations and updated to incorporate the community's increased knowledge of the performance of fusion systems [*and*] **a licensing strategy should be developed** that includes transition from DOE to NRC regulatory authority to ultimately allow for commercialization of fusion power.

Opportunities to Encourage and Support Private Sector

Finding: Opportunities exist to encourage and support private investment in fusion energy development and the focused, goal-oriented approach from U.S. industry, which is beneficial to fusion energy development.

Recommendation: The U.S. DOE OFES should define mechanisms to manage assignment of intellectual property as a means to encourage both private and publicly funded researchers to establish mutually beneficial partnerships.

Recommendation: The U.S. DOE OFES should conduct outreach initiatives that engage the fusion research community and inform the nation. **Public awareness is a critical element in maintaining support.**

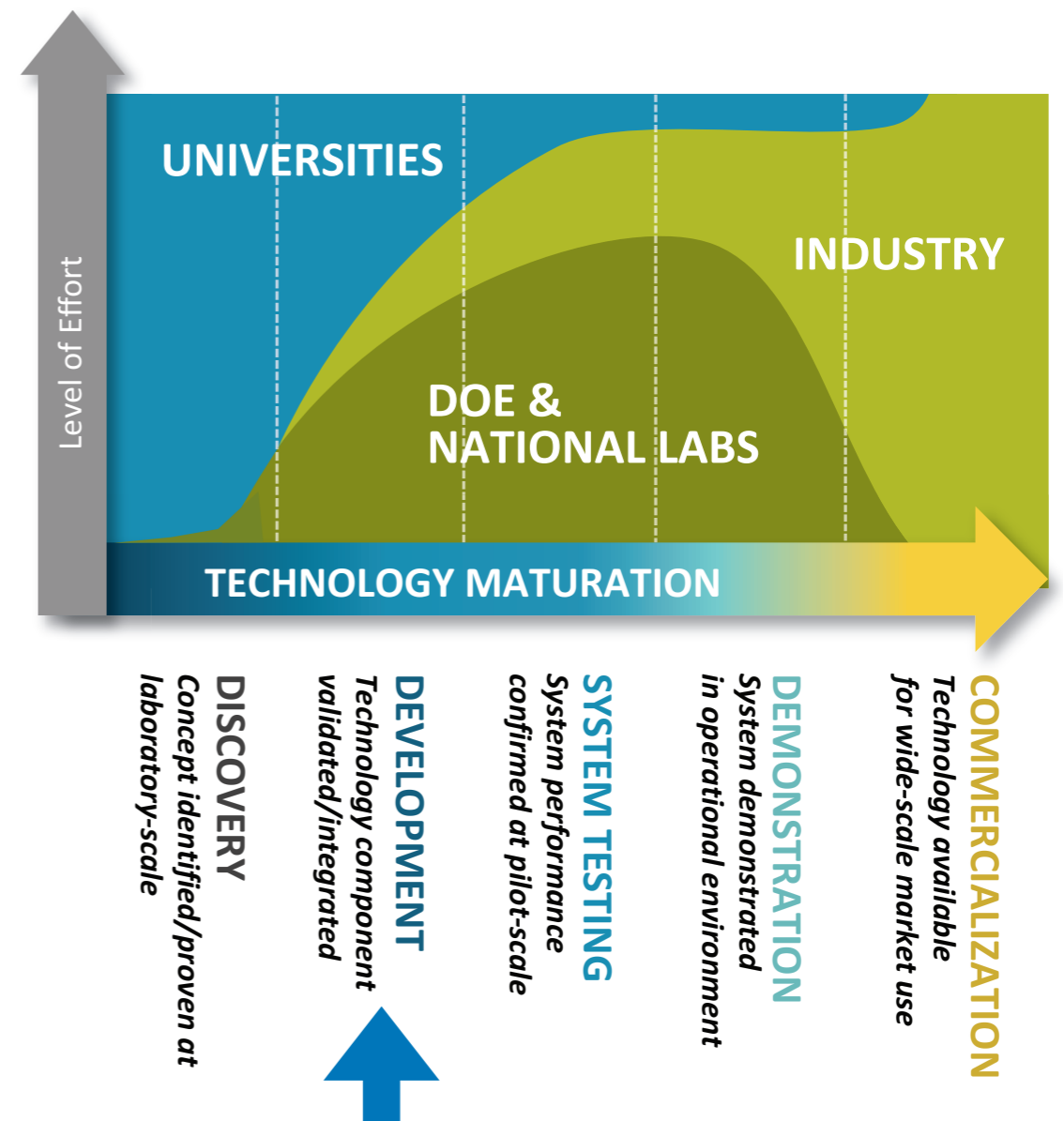

The institutional balance of science and technology research evolves with maturity and technical readiness of the technology. From the 2017 *Annual Report on the State of DOE National Laboratories*.

Next Steps in Planning: NAS Decadal

- **NAS Decadal Assessment of Plasma Science:** “past progress and future promise of plasma science and technology”
 - ▶ **Significant progress and achievement:** burning plasma research in support of ITER and research progress beyond ITER towards fusion electricity.
 - ▶ **Frontiers of burning plasma research** (integrated with materials science, fusion engineering science): understanding and controlling a burning plasma, achieving steady operation at high-power density conditions with high confinement performance and optimized plasma exhaust
 - ▶ **Innovations in burning plasma science** that can accelerate fusion development or improve and reduce the cost of fusion as a source of electricity

Next Steps in Planning: DPP/FESAC

- **FESAC Long-Range Strategic Planning Activity:** “Identify and prioritize” near- and mid-term research:
 - ▶ Understand the science, production, and control of a burning plasma with ITER,
 - ▶ Demonstrate the science and engineering to sustain a magnetically confined plasma with the confinement and power-handling properties needed for a compact fusion pilot plant,
 - ▶ Advance very high-field superconducting magnets for fusion,
 - ▶ Expand research in fusion nuclear science, materials science, and tritium and blanket technologies needed to fully enable fusion electricity, and
 - ▶ Promote promising innovations in burning plasma science and fusion engineering science.

Next Steps in Planning: DPP/FESAC

- **FESAC Long-Range Strategic Planning Activity:** “Identify and prioritize the research required to advance both the scientific foundation needed to develop a fusion energy source, as well as the broader FES mission to steward plasma science.”

Comments:

- ▶ **“Now is the right time** for the United States to develop plans to benefit from its investment in burning plasma research and take steps towards the development of fusion electricity for the nation’s future energy needs.”

⇒ The committee’s strategy guidance goes beyond advancing the “scientific foundation”

- ▶ **Remain an ITER partner** as the most cost-effective way to gain experience with a burning plasma at the scale of a power plant.

In the near-term: maximize the scientific and technical benefits from partnership in a burning plasma experiment. **In the longer-term:** develop and test burning plasma scenarios on ITER that contribute to reliable operation of a compact fusion pilot plant.

- ▶ **Start (now) a national program of accompanying research and technology** leading to the construction of a compact pilot plant which produces electricity from fusion at the lowest-possible capital cost.

Please see committee and report information at:
<https://www.nap.edu/25331>

*The National
Academies of* | SCIENCES
ENGINEERING
MEDICINE

Final Report of the Committee on a Strategic Plan for

BURNING PLASMA RESEARCH

Download the report at [nap.edu/25331](https://www.nap.edu/25331)

Backup Slides

FINAL REPORT OF THE COMMITTEE ON A
STRATEGIC PLAN FOR U.S. BURNING
PLASMA RESEARCH

**Please see committee and report information at:
<https://www.nap.edu/25331>**

Compact Approach Uses Smaller, Less Costly Facilities

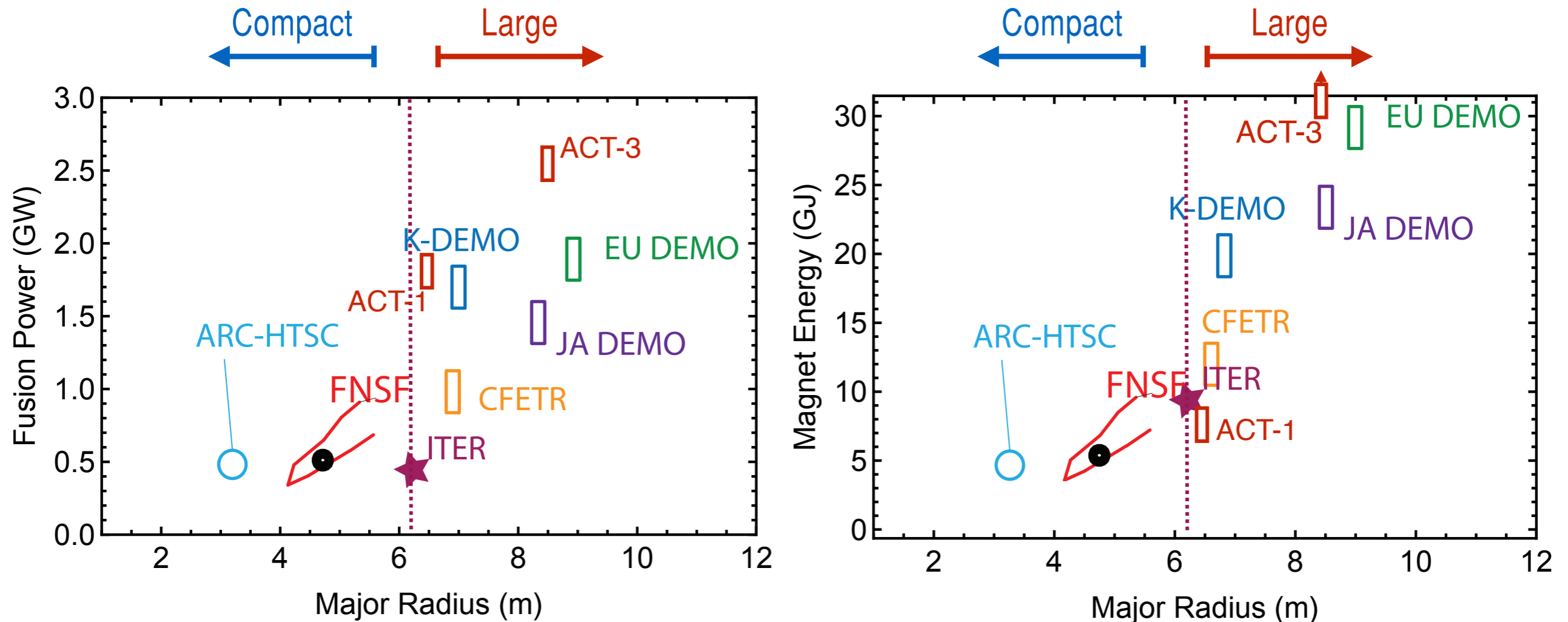

Finding: Recent advances motivate a new national research program leading to the construction of a compact fusion pilot plant at the lowest possible capital cost that will accelerate the fusion development path. Significant progress has been made to predict and create the high-pressure plasma required for such a reactor. This progress combined with opportunities to develop technologies for fusion, such as high-temperature superconducting magnets and advanced materials, **now make a compact device technically possible, affordable, and attractive for industrial participation.**

A Compact and Lower-Cost Pathway to Fusion Electricity

(from Tom Brown, Fusion Engineer PPPL)

Korean DEMO 6.8m

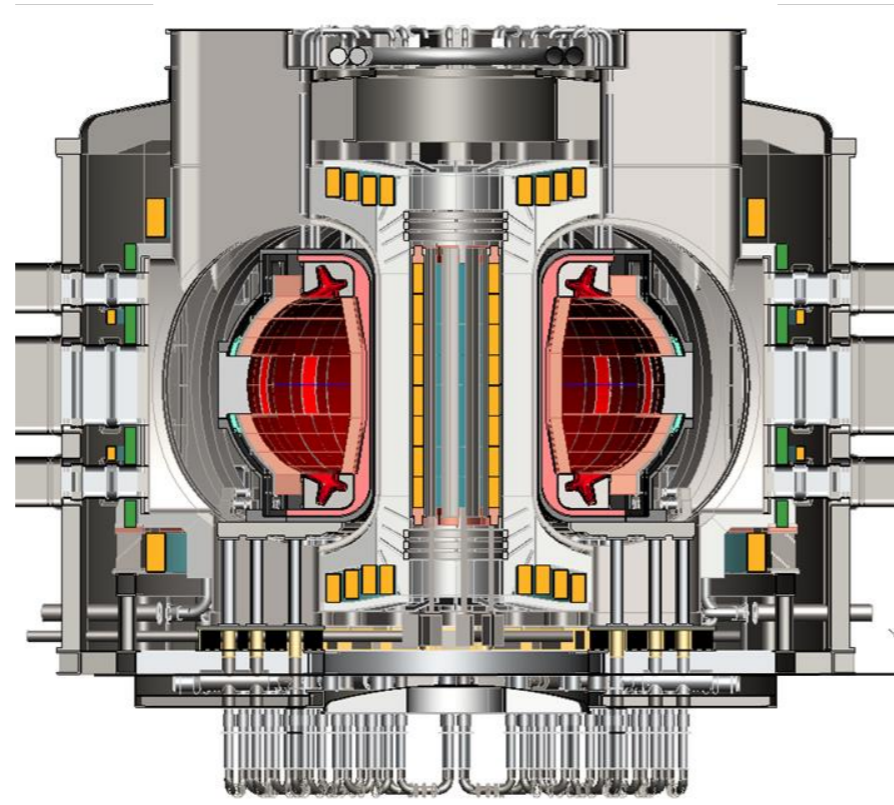

PPPL 4.0m Pilot Plant

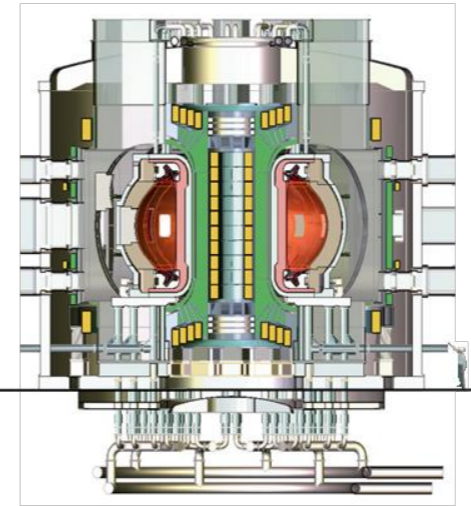

Relative to previous pathways, the compact fusion pathway targets smaller device size, lower capital cost, and shorter development steps.

Cost metric for fusion development should not be estimates of leveled C.O.E., but capital cost and the cost of the development pathway.

A research approach that includes the production of electricity makes **overall systems efficiency an essential part of the evaluation of the compact fusion pilot plant.**

Although promising concepts exist,

Additional research and engineering will be needed to identify the optimal approach.

Compact Fusion: High-Field Superconducting Magnets *and* Advanced Burning Plasma Physics

Recommended

Not Recommended

COMPACT

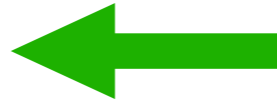

EXPERIMENT



LARGE DEMO

(a) Compact, High-Performance, Steady-State

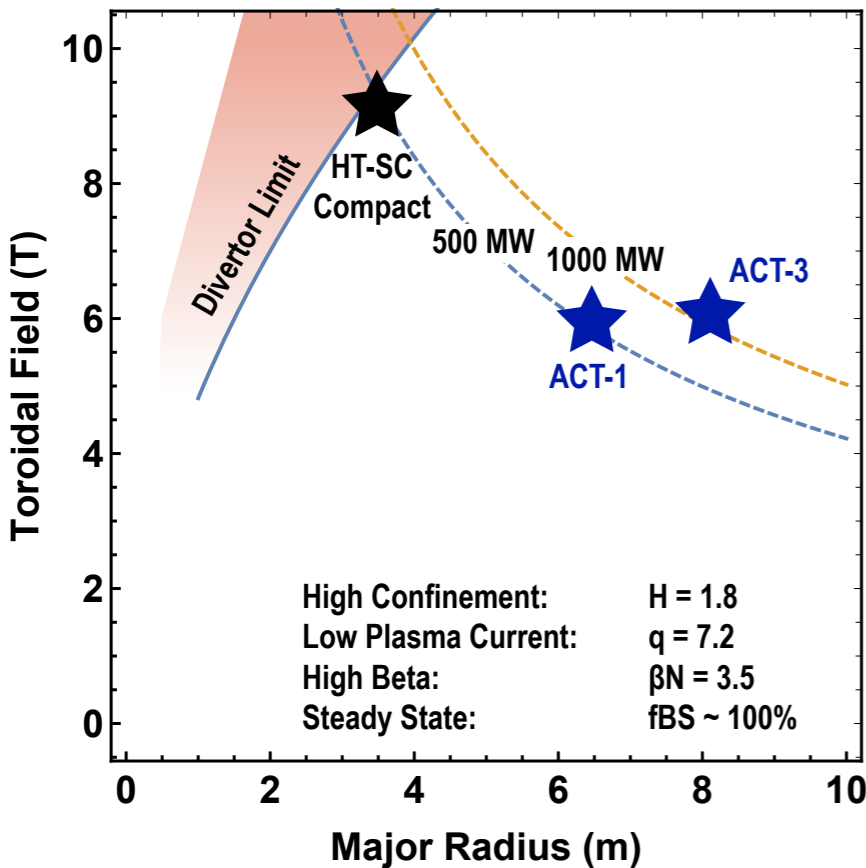

(b) Pulsed, Burning Plasma Experiment

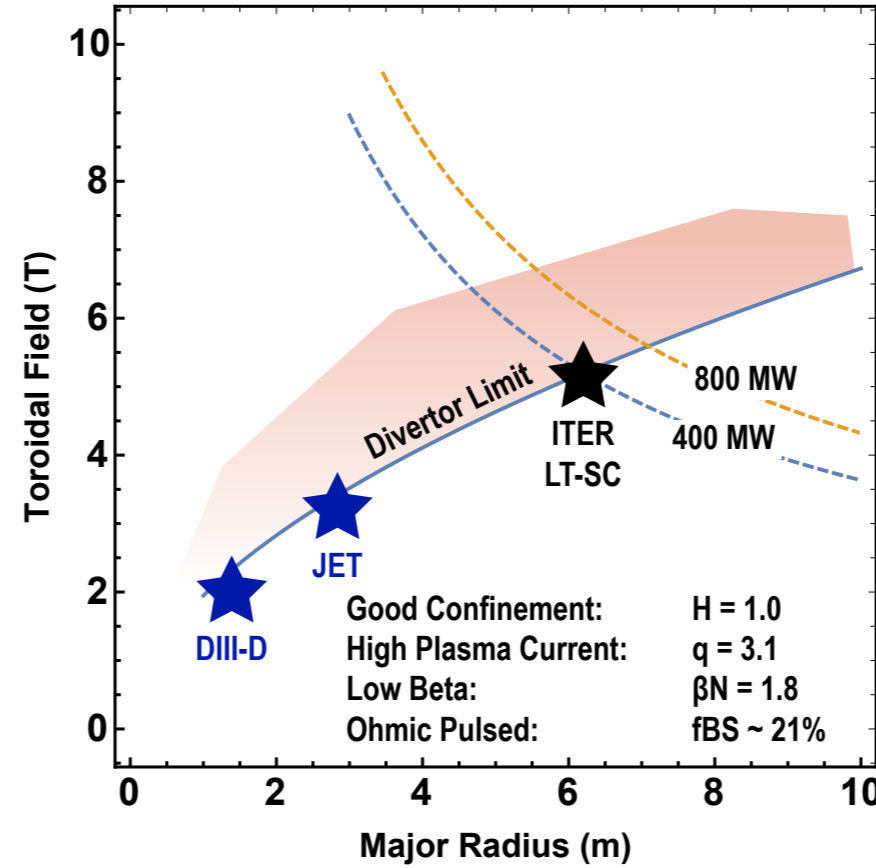

(c) Large, Steady-State DEMO with Current Drive

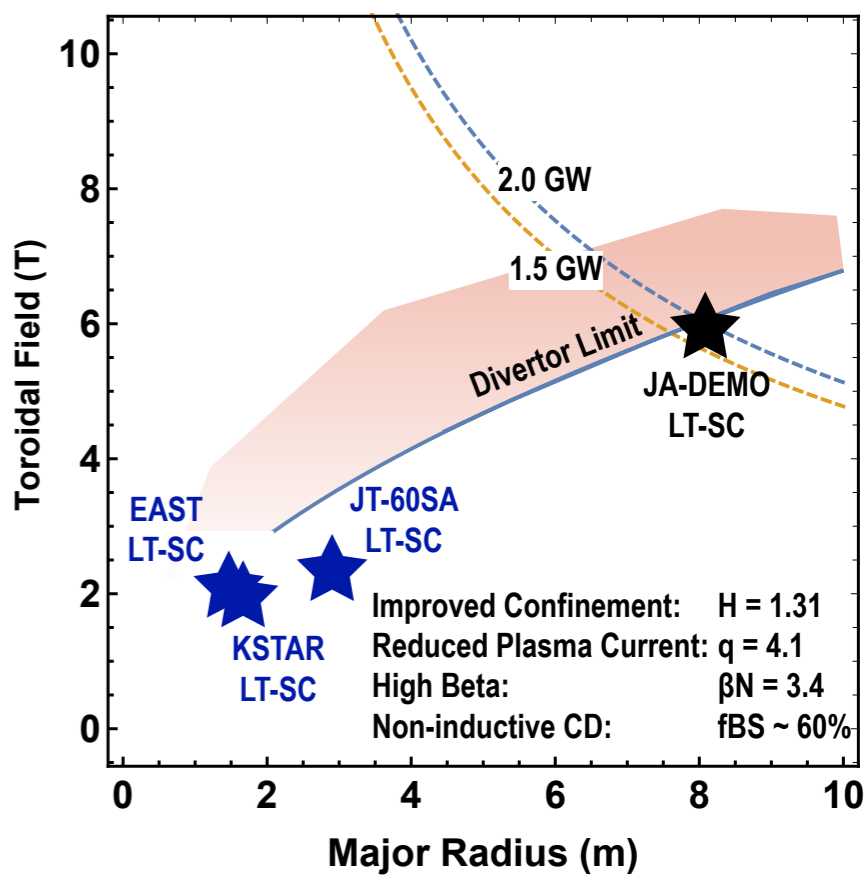

Magnetic fusion as a function of magnetic field strength, B , and toroidal major radius, R . The fusion power increases rapidly with both size and magnetic field, R^3B^4 ; the plasma current increases linearly, RB/q ; and the power flux to the divertor is assumed to scale as the product of the plasma thermal power and (B/Rq) .

Recent Advances Motivate a New National Program

Finding: Recent advances motivate a new national research program leading to the construction of a compact fusion pilot plant at the lowest possible capital cost that will accelerate the fusion development path. Significant progress has been made to predict and create the high-pressure plasma required for such a reactor. This progress combined with opportunities to develop technologies for fusion, such as high-temperature superconducting magnets and advanced materials, now make a compact device technically possible, affordable, and attractive for industrial participation.

Supporting this conclusion:

- (i)** Combining new high-field superconductors with advanced burning plasma science,
- (ii)** Advances in understanding divertor scaling,
- (iii)** Progress in achieving uninterrupted operation of high-performance confinement,
- (iv)** Growing industrial capability of HTS superconductors,
- (v)** Prospects for advanced materials science and manufacturing,
- (vi)** Ongoing advances in support of ITER, and
- (vii)** Readiness to pursue innovations to harness fusion energy and to breed and process tritium.

New Near- and Mid-term Research Facilities

Recommendation: In the near- and mid-terms, the U.S. Department of Energy should resolve critical research needs for the construction of a compact fusion pilot plant:

- Understand the **science, production, and control of burning plasma at the scale of a power plant** through participation in ITER.
- Demonstrate the science and engineering needed to **sustain a magnetically confined plasma having the high-confinement property and compatible plasma exhaust system** that are needed for a compact fusion pilot plant.
- Advance high-field, high-temperature superconductors and **demonstrate the ability to achieve high magnetic fields using large, fusion-relevant coils.**
- **Expand significantly the U.S. research program in fusion nuclear technology, advanced materials, safety, and tritium and blanket technologies needed to fully enable fusion energy.**
- **Develop promising innovations** in burning plasma science, such as optimized stellarator configurations and innovative approaches for a low-cost fusion irradiation facility, and fusion engineering science that reduce the cost and improve the fusion concept as a source of electricity.



Full benefit from ITER



Steady-State High-Power Density Research Facility



Fusion Magnet Research



Fusion Nuclear Science and Technology



Innovations in both burning plasma science and fusion technology

The U.S. has been a leader in the Development of High-Field Superconducting Magnets for Fusion

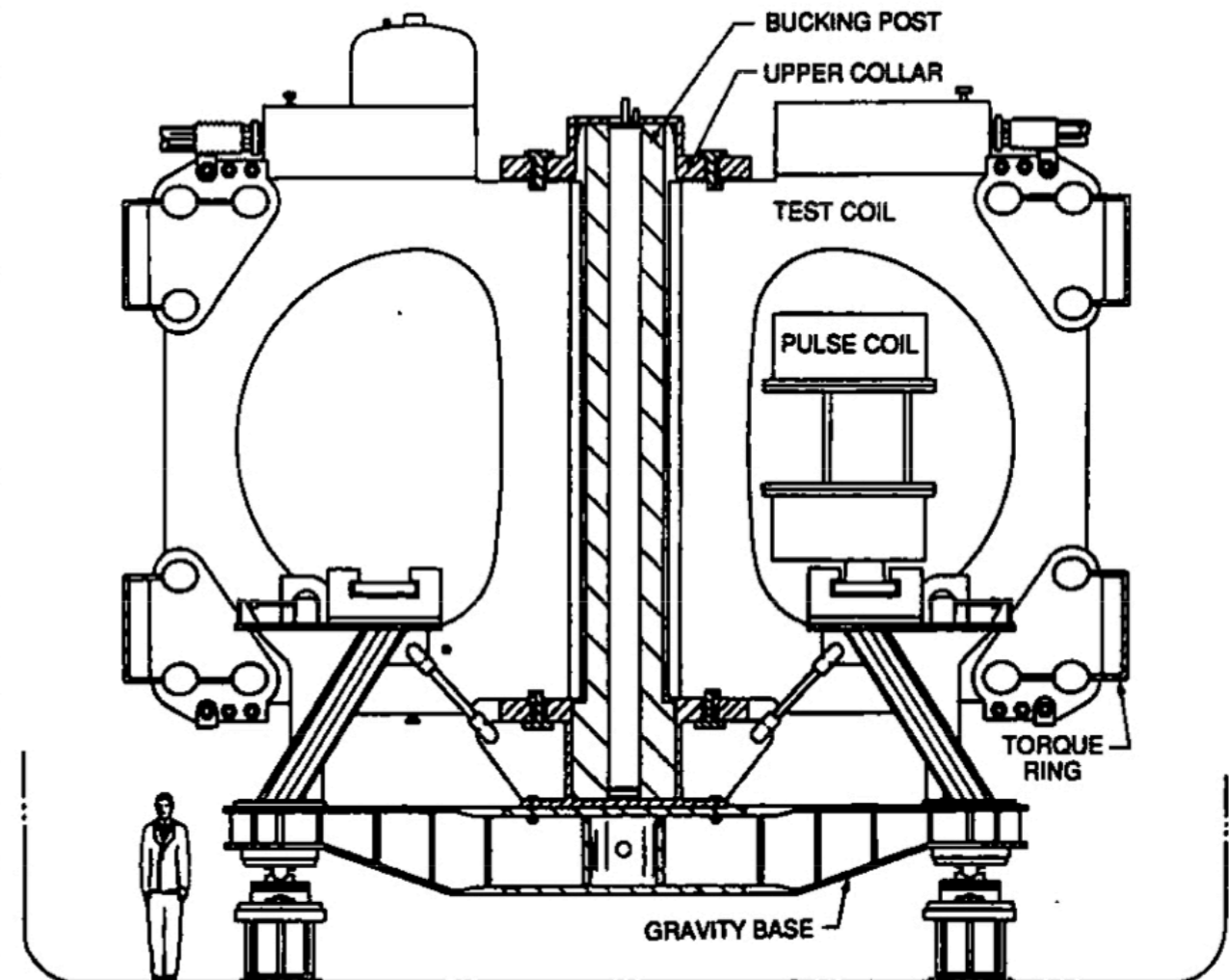
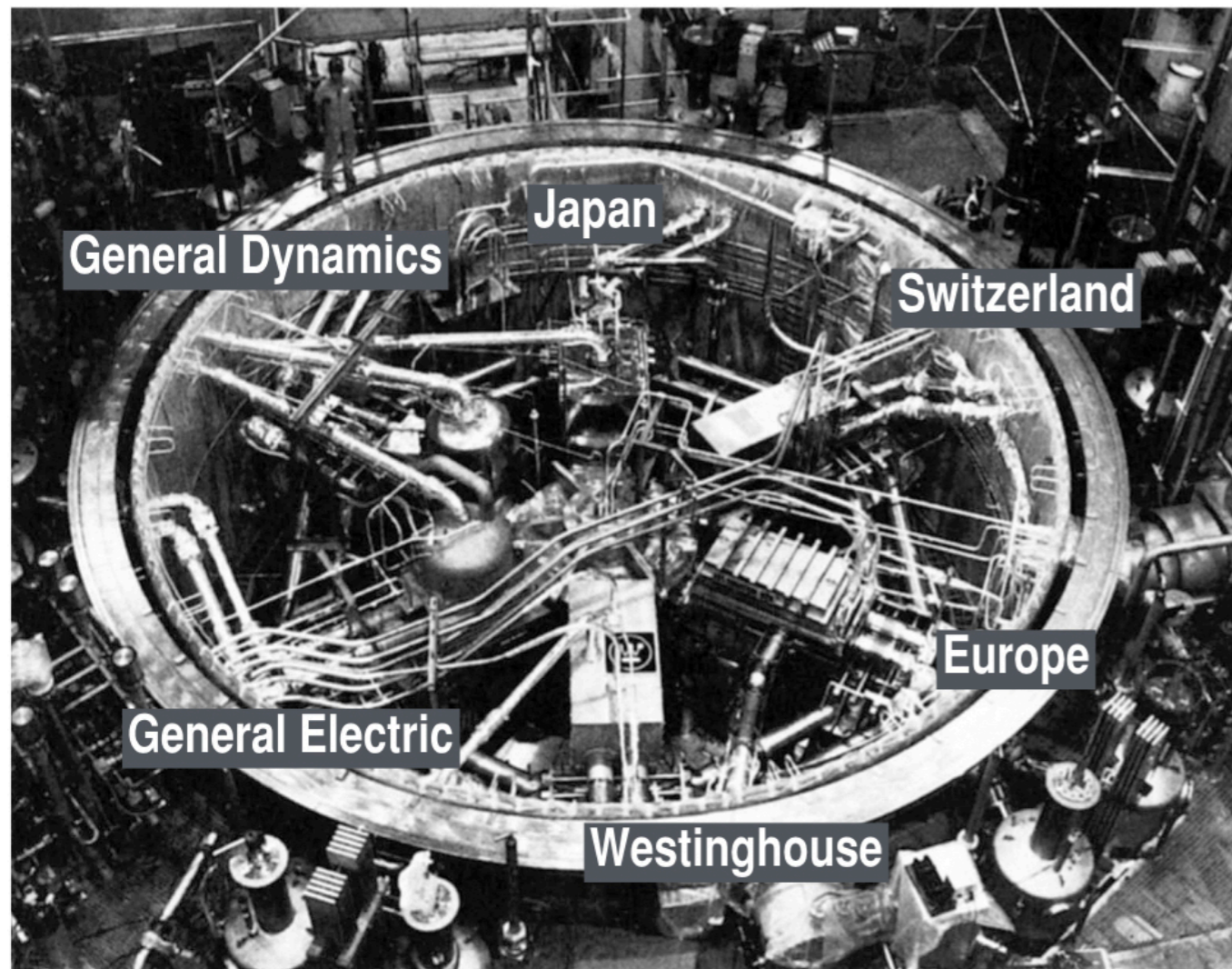

The Large Coil Test Facility managed by ORNL at the International Fusion Superconducting Magnet Test Facility (IFSMTF). Six large-bore fusion magnets from industries in the United States, Switzerland, Europe Atomic Energy Community, and Japan operated for two years (1985-1987), reached stable operation at $B = 8\text{T}$, and successfully demonstrated low-temperature superconducting magnet technology for fusion.

Fusion Nuclear Science

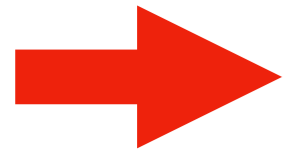

Essential Missing Element in the U.S. Fusion Research Program

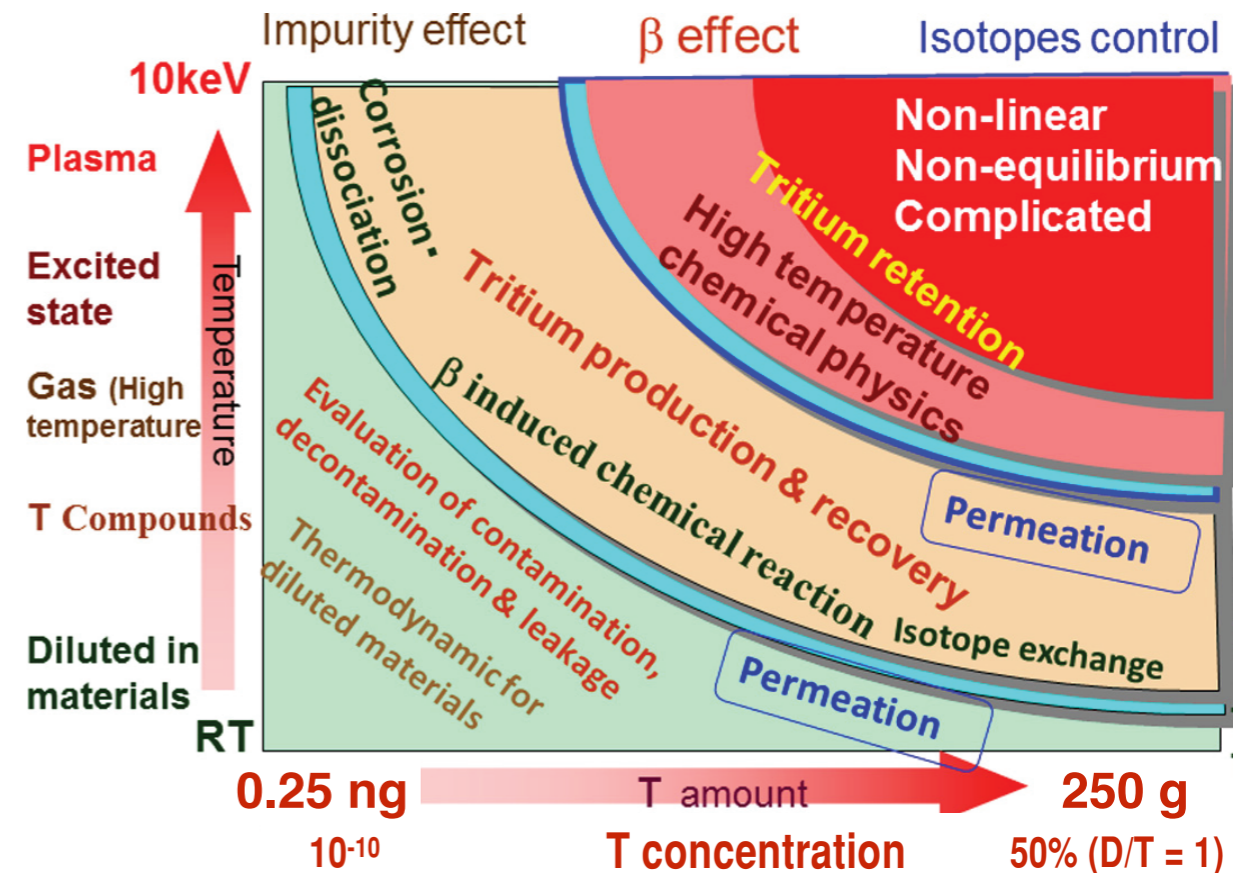
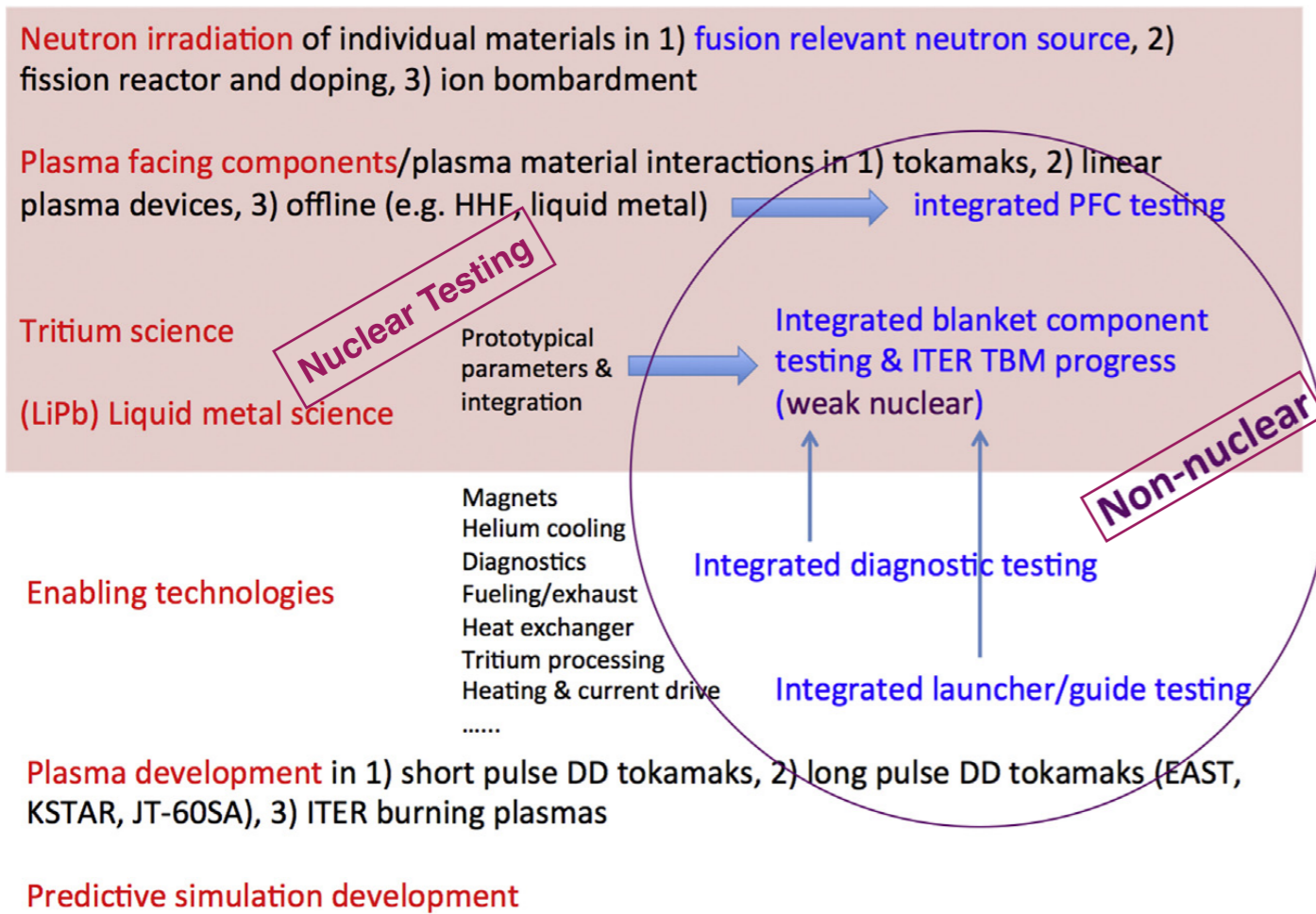

Elements of a fusion nuclear science research program leading to the design and construction of a compact fusion pilot plant. (From Kessel, *Fus Eng Design*, 2017)

Tritium science and materials science required to establish a fusion tritium fuel cycle. (From Tanabe, *J Nucl Mater*, 2013)

Two-Phase Approach to the Fusion Pilot Plant

Recommendation: In recognition of the significant challenges that needs to be addressed for the construction of a compact fusion pilot plant facility capable of electricity production, the U.S. DOE OFES **plan for a pilot plant should have a two-phase approach.** These objectives of these two phases are:

- In the **first phase**, the pilot plant should be capable of demonstrating fusion electricity production for periods lasting minutes and establish the feasibility of electricity production in a compact fusion system including the assessment of plasma material interactions, tritium safety, pumping, recycling, breeding, and extraction.
- In the **second phase**, the pilot plant should be capable of uninterrupted operation for many days allowing fusion materials and component testing consistent with a commercial power plant, including full fuel cycle blanket testing.

Developing an Alternate Approach without ITER Participation

Finding: Without ITER, the United States would need to design, license, and construct an alternative means to gain experience creating and controlling an energy-producing burning plasma. The scale of research facilities within the United States would be more costly. The achievement of electricity production from fusion in the United States would be delayed.

Recommendation: Nevertheless, if the United States decides to withdraw from the ITER project, the U.S. DOE OFES should initiate a **plan to continue research that will lead towards the construction of a compact fusion pilot plant.** This should include the construction of an alternative means to study the burning plasma regime and an alternate method to engage in the international effort in the pursuit of its long-term objective for fusion demonstration.

In addition to a burning plasma experiment, further research is needed to improve and fully enable fusion electricity

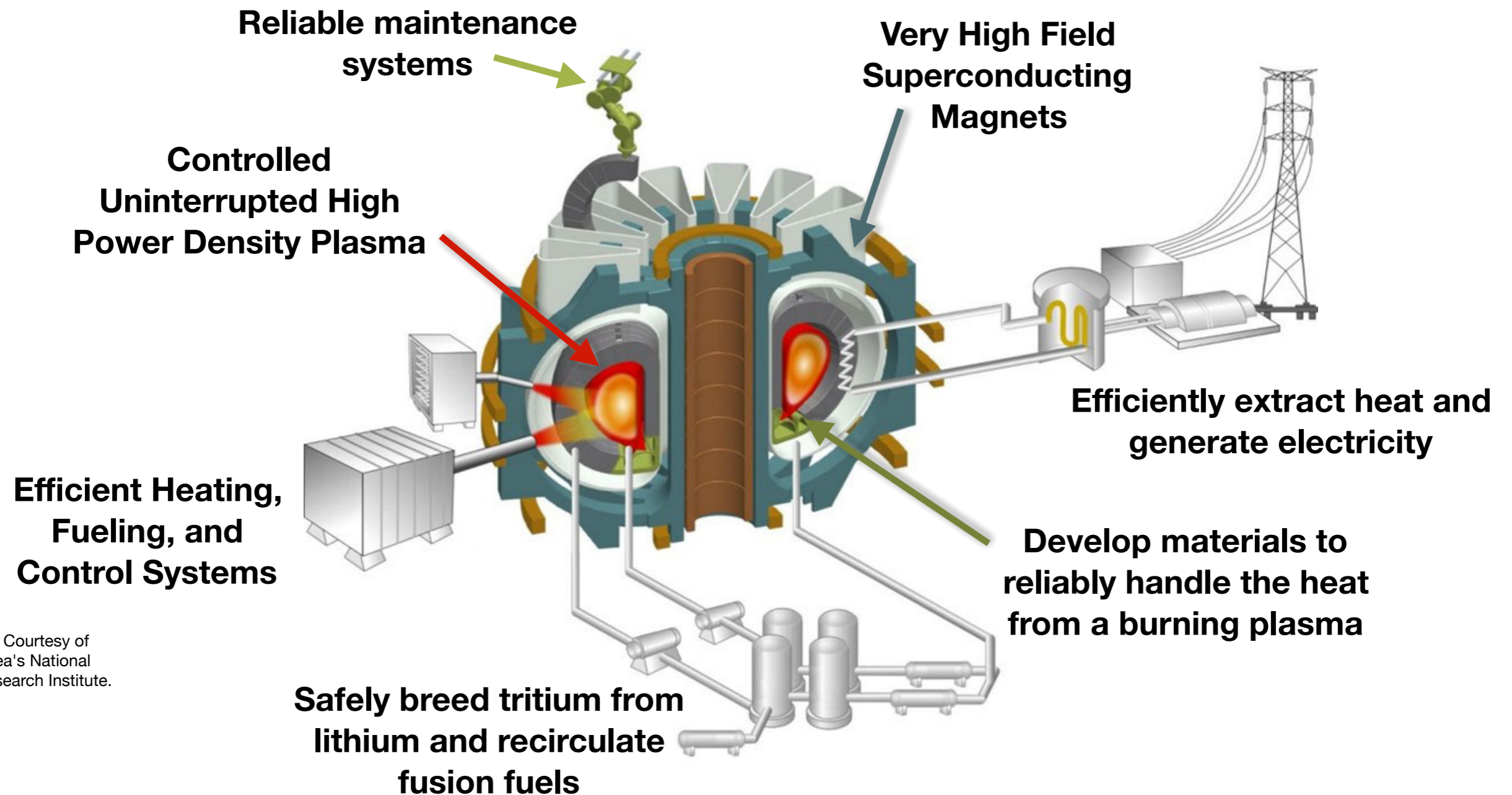

Schematic Courtesy of South Korea's National Fusion Research Institute.

Research is needed to address science and technology challenges and demonstrate innovations that reduce the size and cost of fusion electricity.