

ARPA-E Fusion-Energy Programs and Plans

Presentation to FESAC
Rockville, MD, Oct. 2, 2019

Scott C. Hsu, Program Director, ARPA-E
scott.hsu at hq.doe.gov

Malcolm Handley, T2M Consultant, ARPA-E
Colleen Nehl, Technical Support, Booz Allen Hamilton



High-level ARPA-E perspective

- ▶ Fusion strategic plan should be responsive to dynamic constraints imposed by evolving energy markets through an adequately diverse portfolio
 - Very different energy landscape shaped today's fusion program
 - The competition today: LCOE <6 ¢/kWh, unit size <<1 GWe, capital cost <\$1B, <\$2/W
 - Fusion should absorb fission's lessons (i.e., reduced capex and opex)
- ▶ Increased alignment between federal and private efforts could enhance fusion's near-term relevance and raise the tide for all boats
 - Private fusion investments represent significant market pull
 - Little federal support today in specific areas of interest to private companies
 - Federal leadership-class capabilities will help accelerate private efforts
 - Difficult for federal or private efforts alone to achieve timely, commercially viable DEMO
- ▶ ARPA-E stands ready to coordinate further with FES; we can contribute strongly to
 - Developing impactful fusion public-private partnerships
 - Providing a detailed understanding of energy markets and commercialization requirements
 - Making connections to other energy researchers solving synergistic problems

Outline

- ▶ Introduction
- ▶ Brief review of the ALPHA* program (2015–2019)
- ▶ Fusion program plans (2019–?)
- ▶ Q&A (lots of backup materials)

ARPA-E is an agency within the U.S. Dept. of Energy modeled after DARPA

Mission: To overcome long-term, high-risk technological barriers in energy-technology development by providing applied R&D funding for high-risk, high-reward transformational ideas



FY19 Enacted: \$366M
FY20 House: \$425M
FY20 Senate: \$428M

ARPA-E supports transformative applied energy R&D, bridging the gap between basic research and energy commercialization

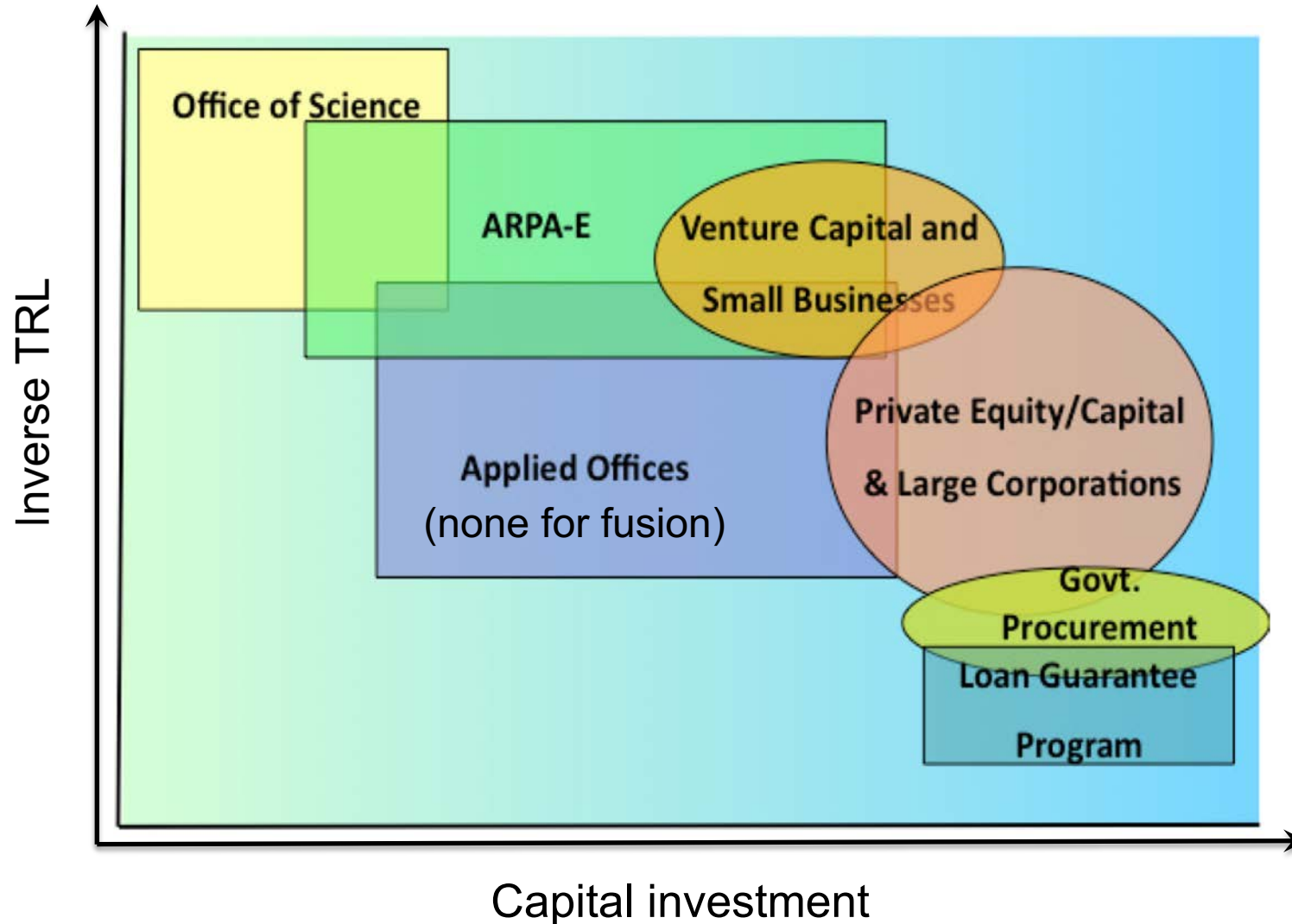

ARPA-E supports transformative applied energy R&D, bridging the gap between basic research and energy commercialization

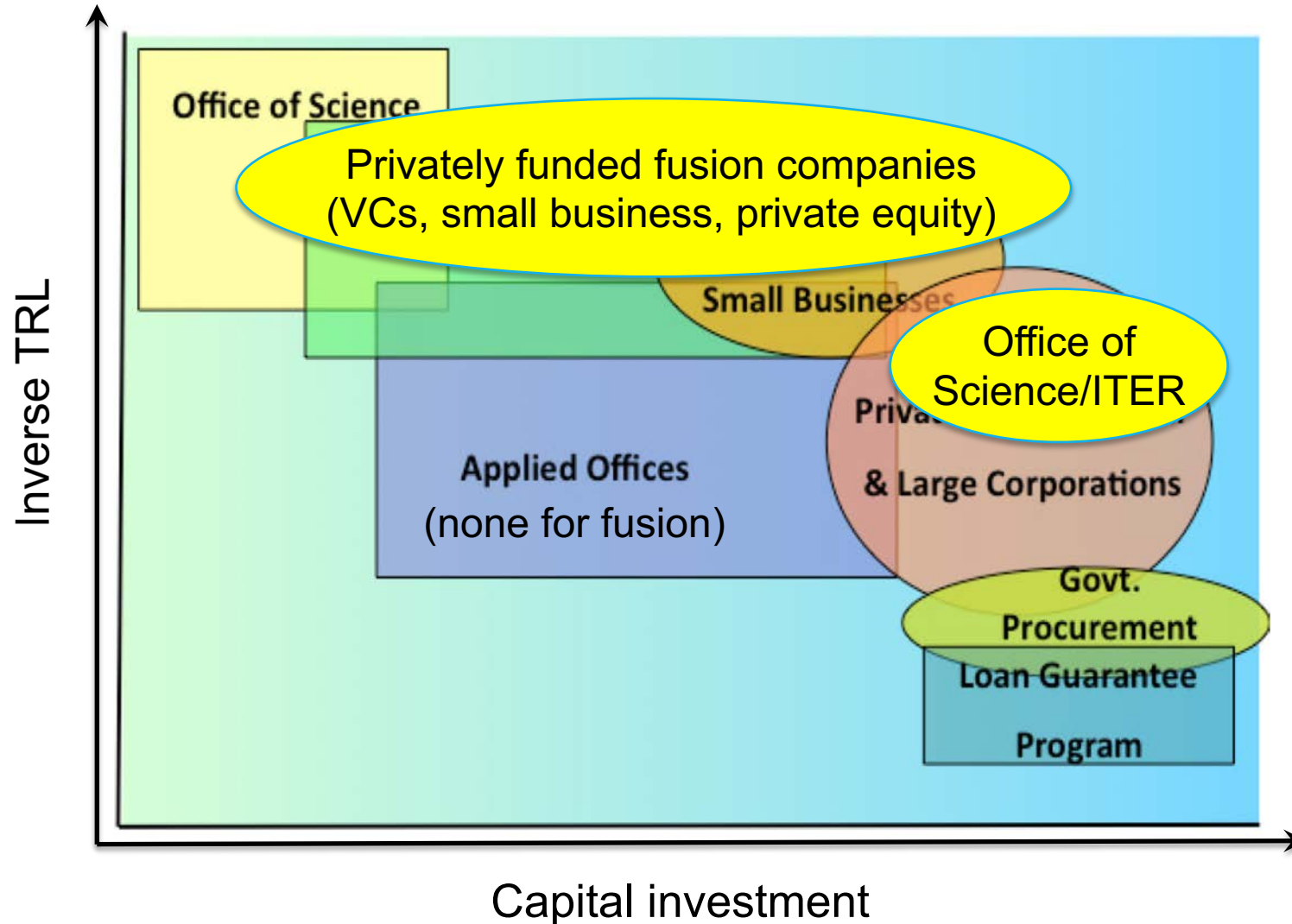

ARPA-E program development and execution process

- Collaborative milestone negotiation
- Active project management and feedback
- Attention to T2M

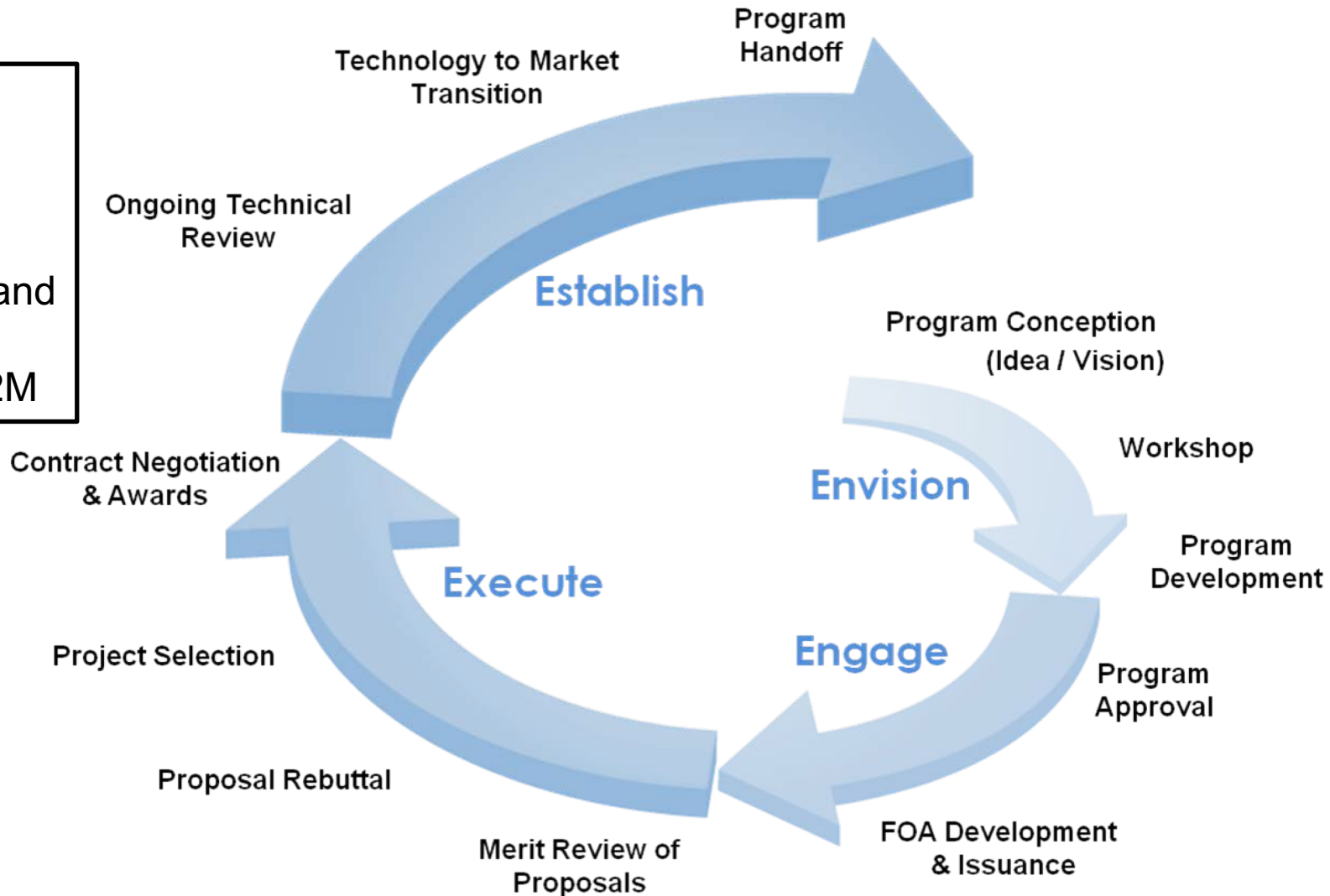

- Situational awareness
- Identification of “white space”
- Stakeholder engagement

What problem is fusion trying to solve? Risk mitigation for achieving a cost-effective zero-carbon grid by mid/late century

- Significant gap exists to achieve zero or negative carbon emissions by mid/late century
- Firm, low-carbon sources needed to keep costs reasonable

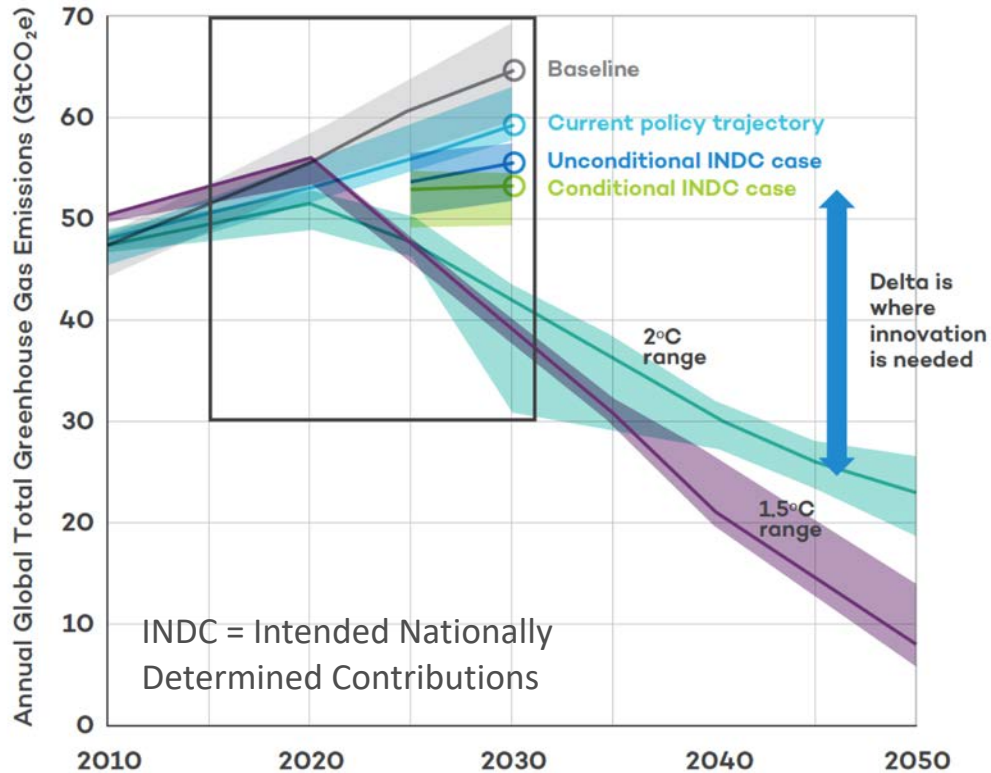

Energy Futures Initiative, 2018 (modified from [UNEP Emissions Gap Report, 2017](#)).

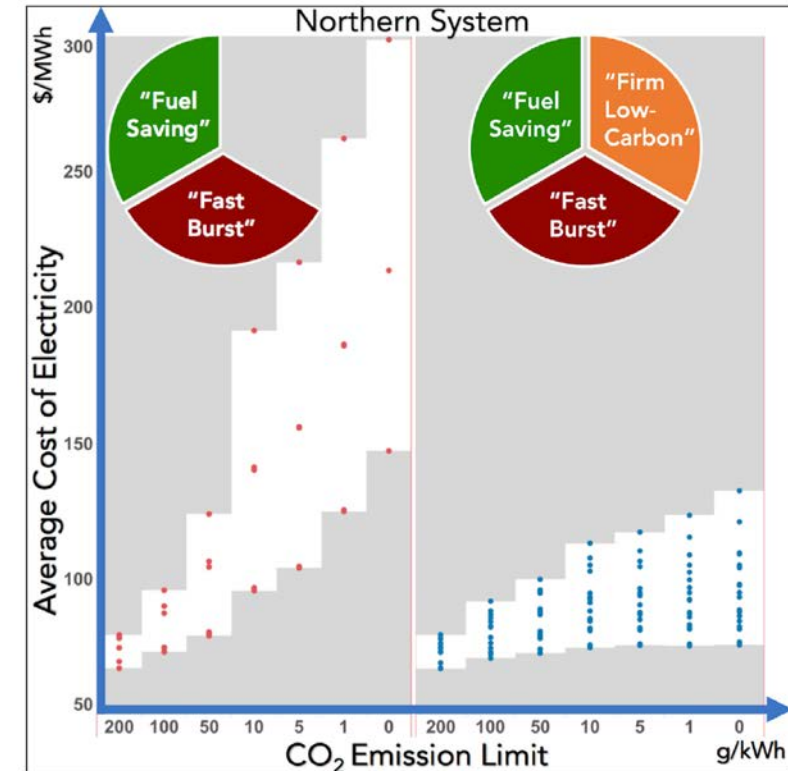

N. A. Sepulveda et al., [Joule 2, 2403 \(2018\)](#)

How much does fusion need to cost? We don't know for sure but have an idea based on competition and financing

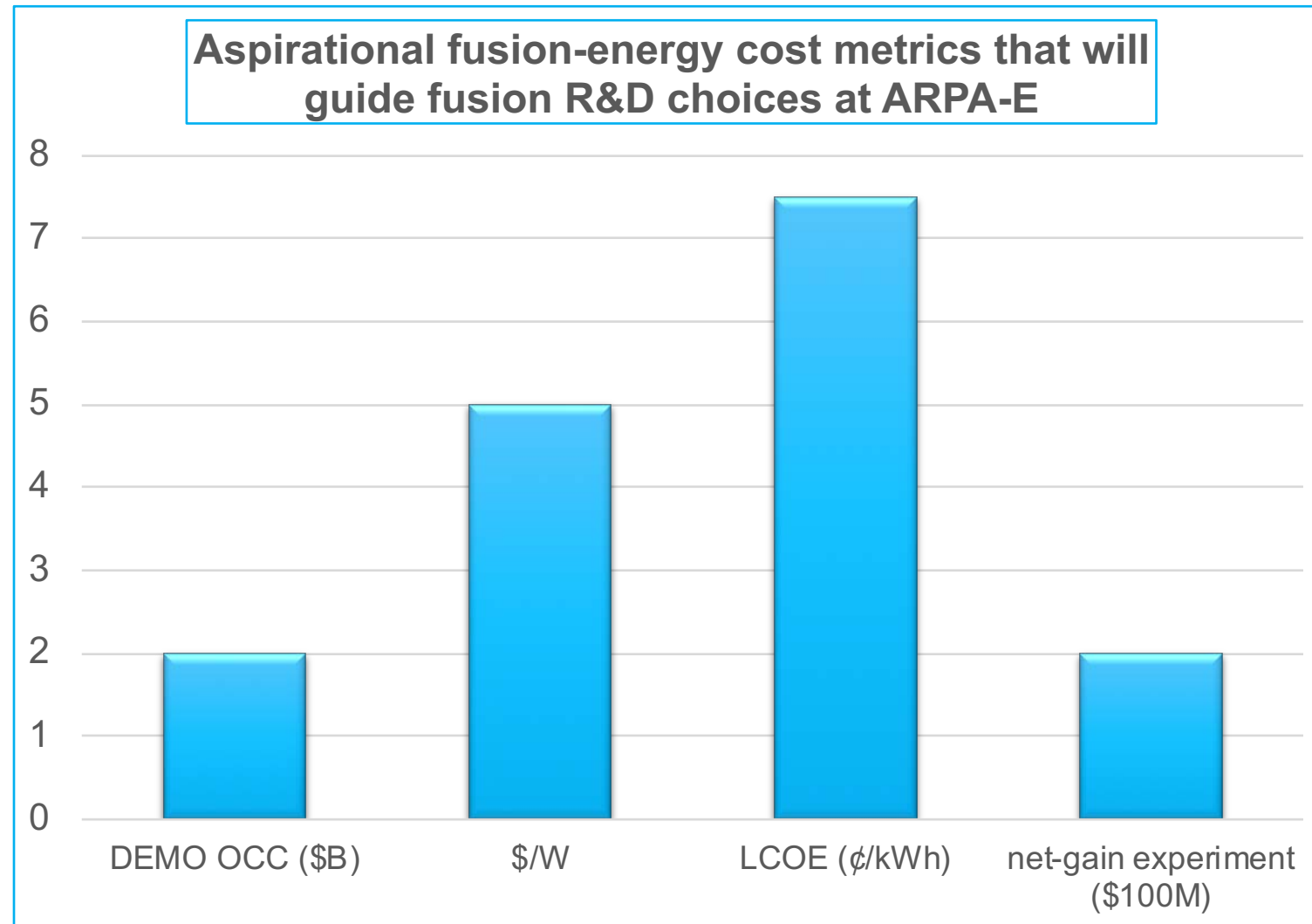

Outline

- ▶ Introduction
- ▶ Brief review of the ALPHA* program (2015–2019)
- ▶ Fusion program plans (2019–?)
- ▶ Q&A (lots of backup materials)







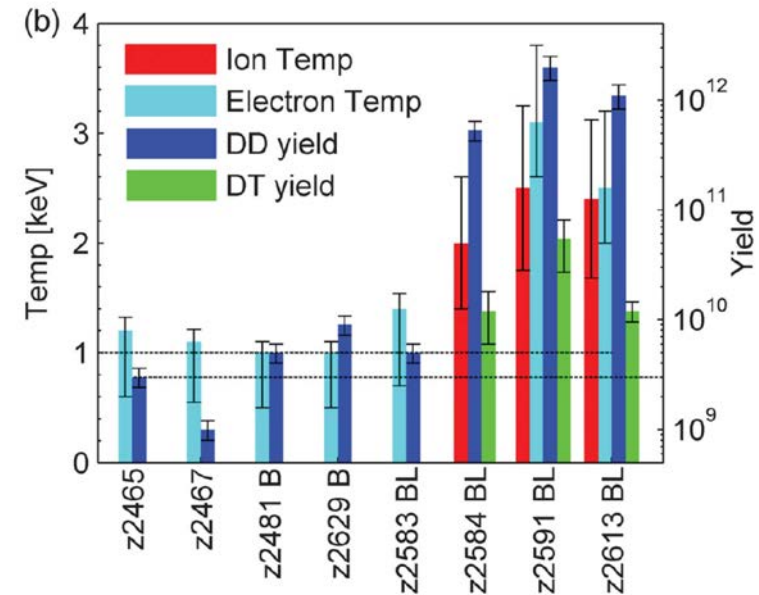
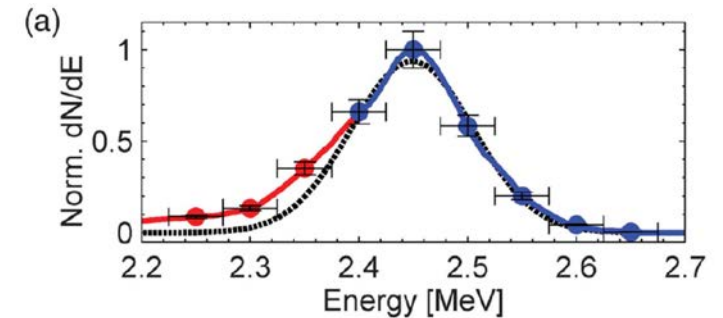

ALPHA program objectives (\$30M over 3–4 years)

- ▶ Explore lower-cost path to fusion-energy development and eventual deployment
- ▶ Focus on pulsed approaches with final density of 10^{18} – 10^{23} cm^{-3}
 - Magneto-inertial fusion (MIF) and Z-pinch variants
- ▶ Enable rapid learning
 - High shot rate: hundreds of shots during ALPHA, scalable to ≥ 1 Hz in a future power plant
 - Low cost per shot: “drivers” $< \$0.05/\text{MJ}$ and “targets” < 0.05 ¢/MJ over life of plant

Sandia MagLIF provided convincing MIF proof of concept \rightarrow helped justify the program



ALPHA portfolio (awards ~\$400k–\$5.9M)

Integrated concepts	Driver development	Applied MIF science
<p>Magnetic compression of an FRC</p> 	<p>Plasma guns to form high-speed plasma liners</p> 	<p>Underlying science of MIF at fusion conditions</p> 
<p>Shear-flow-stabilized Z-pinch (direct pulsed power)</p> 	<p>Scalable MEMS-based ion accelerator</p> 	<p>Helical Taylor state as stable plasma target</p> 
<p>Staged Z-pinch (direct pulsed power)</p> 	<p>Piston-driven liquid liner</p> 	<p>Physics of plasma compression</p> 

ALPHA portfolio (awards ~\$400k–\$5.9M)

Integrated concepts

Magnetic compression of an FRC

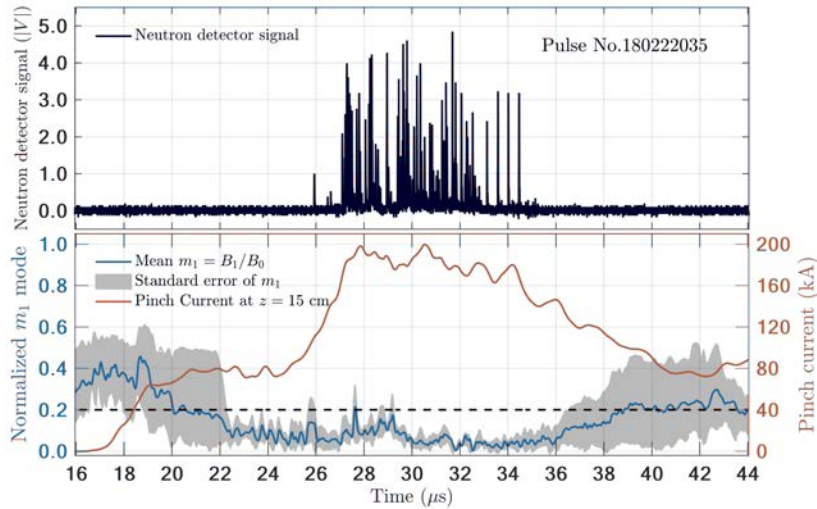

Staged Z-pinch (direct pulsed power)



Driver development

Plasma guns to form high-speed plasma liners



300 keV model

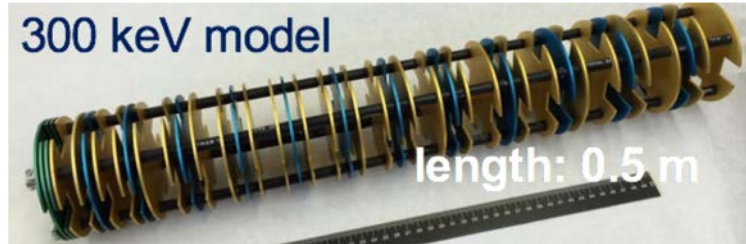

Piston-driven liquid liner

NumerEx



Applied MIF science

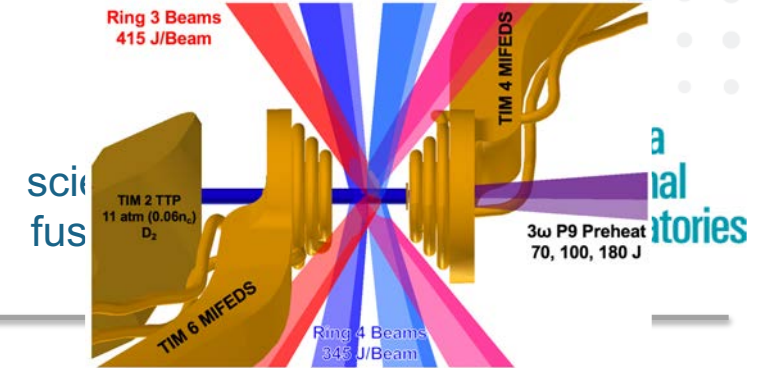

Helical Taylor state as stable plasma target



Physics of plasma compression



Summary of ALPHA outcomes

- ▶ Technical outcomes
 - Evidence of >1-keV temperatures and DD neutron production for 3 integrated concepts
 - Demonstrated two new, potential compression-driver technologies
 - Developed three new, low-cost, high-shot-rate platforms to study MIF target physics
- ▶ Tech-2-market (T2M) outcomes
 - 3 new spinoff companies and \$35M private capital raised by ALPHA projects*
 - Dozens of peer-reviewed publications, 6 patent applications filed, APS-DPP mini-conference (2018)
 - ALPHA teams among the founding members of the [Fusion Industry Association](#)
- ▶ Positive (but cautious) findings from 2018 JASON [report](#):
 - MIF within 10% of scientific breakeven for ~1% of total US fusion R&D funding
 - Near-term priority should be scientific breakeven in a system that scales to commercial power plant
 - Support all promising approaches; do not concentrate resources on early frontrunners

Outline

- ▶ Introduction
- ▶ Brief review of the ALPHA* program (2015–present)
- ▶ Fusion program plans (2019–?)
- ▶ Q&A (lots of backup materials)

ARPA-E interested in transformative fusion R&D to help enable grid-ready fusion demo in ~20 years for OCC* < “few \$B”

Cost constraint



Develop credible lower-cost concepts with identifiable upside potential (MIF and others)

Develop technologies with potential to drastically reduce cost for tokamaks, stellarators, IFE

Timeliness constraint



Catalyze technology/engineering development for commercially motivated fusion concepts

Priorities: plasma-facing/blanket, tritium-processing, and high-duty-cycle enablers

see [Request for Information](#)
(50 responses, will provide to FES/ CPP PC for responses with authors' permission)

Potential program A: Develop credible fusion concepts that may cost ~O(\$100M) for net gain and ~O(\$1B) for grid-ready demo

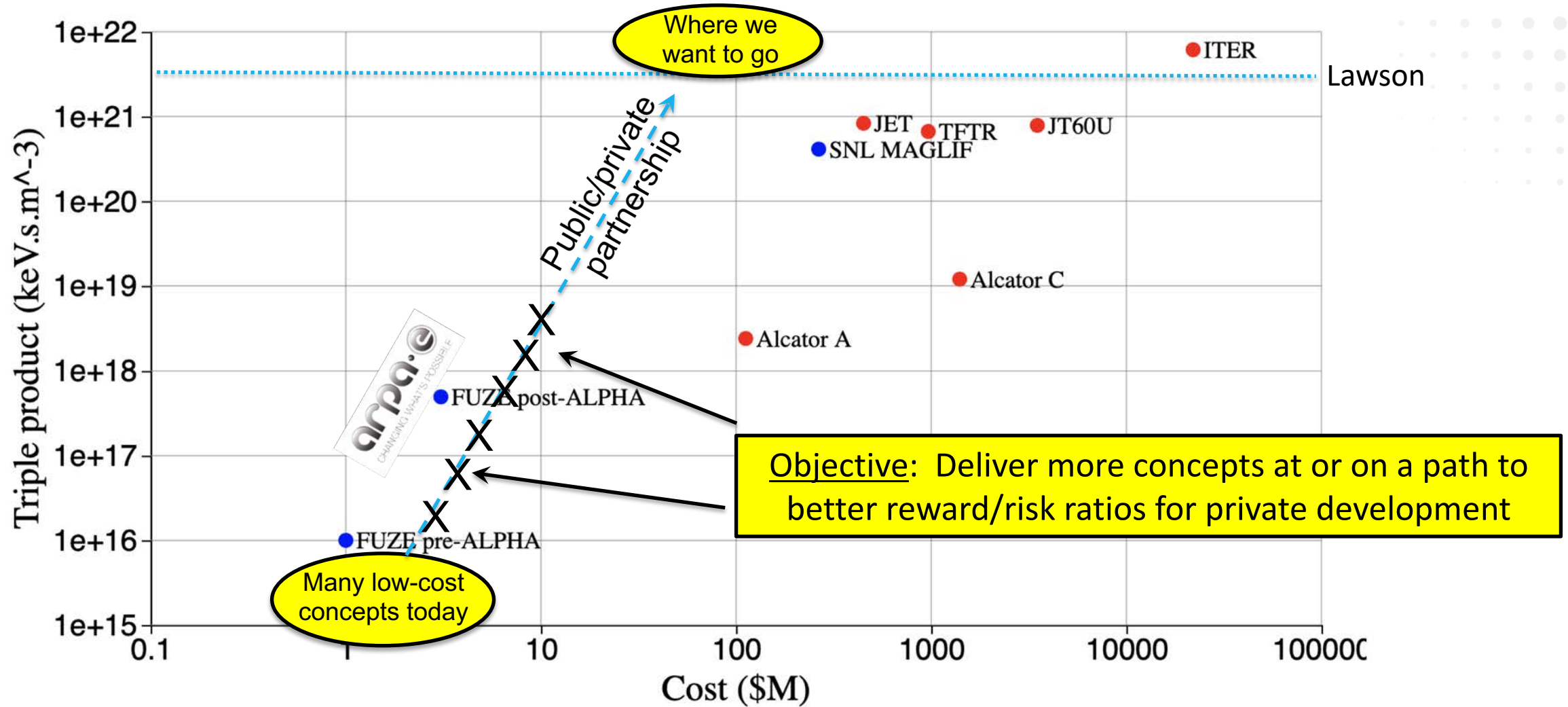

Potential program B: Catalyze enabling-technology solutions to common challenges of commercially motivated fusion concepts

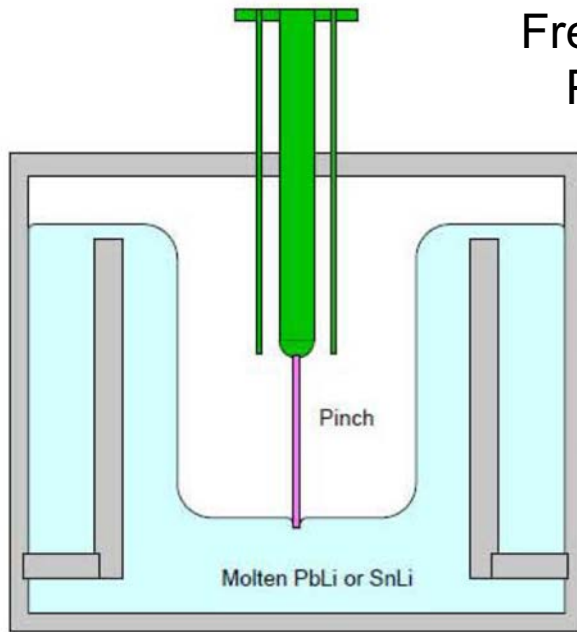

Free-surface liquid
PbLi first walls

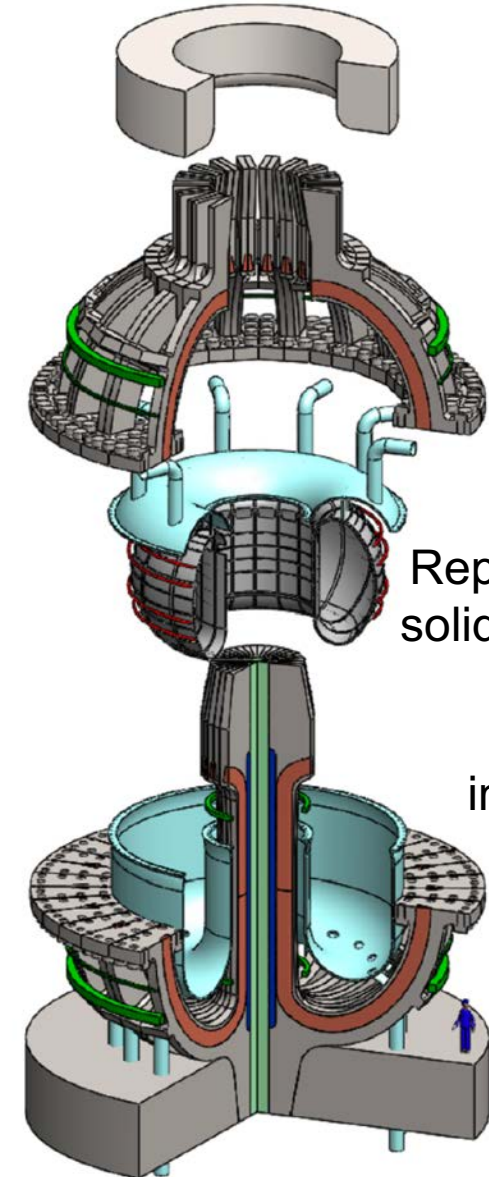

- Engage outside communities
- Enable use of thick liquid blankets
- Tritium process intensification to minimize tritium inventory
- Accelerated subscale material testing

- Beyond solid divertors
- Exploit advances in modern power electronics
- Advanced fuels and power cycles

Different but synergistic challenges/requirements compared to ITER-based DEMO

ARPA-E is exploring idea of “capability teams” to support fusion concept teams

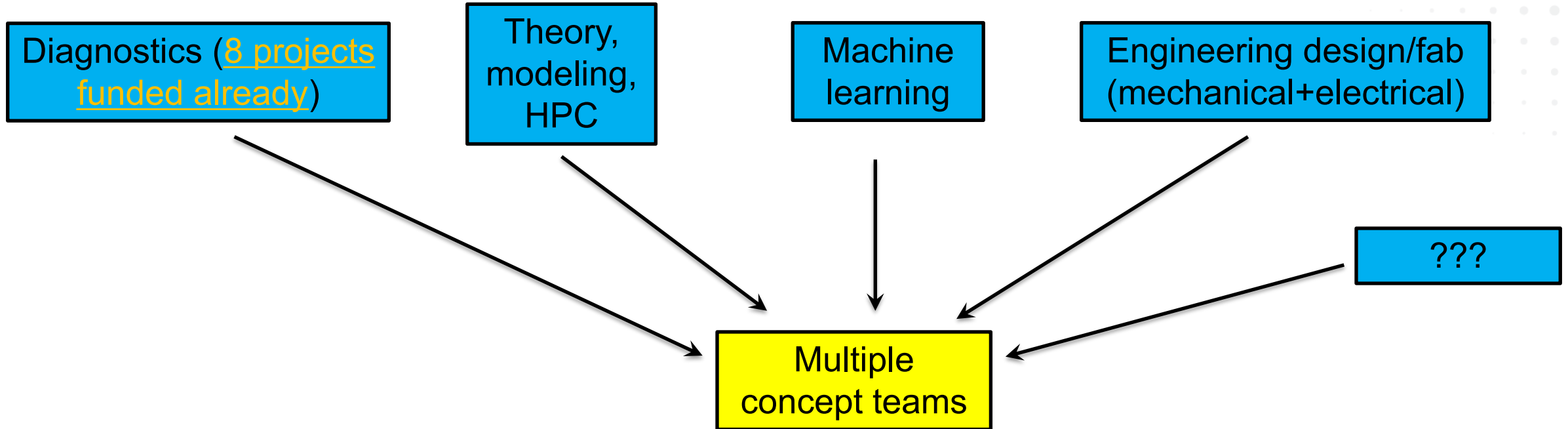

Leverage the best expertise Avoid reinventing the wheel by each concept team Stretch limited \$\$ Build public-private partnership

Fusion T2M plans at ARPA-E: Smoothing the pathway to fusion commercialization

- ▶ Support studies to identify first markets for fusion at a range of unit size and cost
- ▶ Weave in programmatic structure and incentives for public-private partnering
- ▶ Build finance scaling through investor engagement
- ▶ Help establish fusion regulatory certainty and public acceptance

SC/FES legislation of interest/relevance to ARPA-E

- ▶ H.R. 589 “Department of Energy Research and Innovation Act” (became public law no. 115-246 on 9/28/2018):
 - SC/ARPA-E coordination on fusion energy
 - Support IFE and a portfolio of alternative and enabling fusion energy concepts
- ▶ S. 97 “Nuclear Energy Innovation Capabilities Act of 2017” (became public law no. 115-248 on 9/28/18)
 - Extensive language on memorandum of understanding between DOE and NRC to benefit advanced-reactor testing, development, and demonstration including fusion
- ▶ Pending FY20 Senate appropriations language on private-public partnership:
 - Up to \$20M for INFUSE
 - Up to \$20M to initiate a (NASA/COTS-like) cost-share program for integrated prototype demonstrations over the next 5 years

Outline

- ▶ Introduction
- ▶ Brief review of the ALPHA* program (2015–present)
- ▶ Fusion program plans (2019–?)
- ▶ Q&A (lots of backup materials)

History of ARPA-E



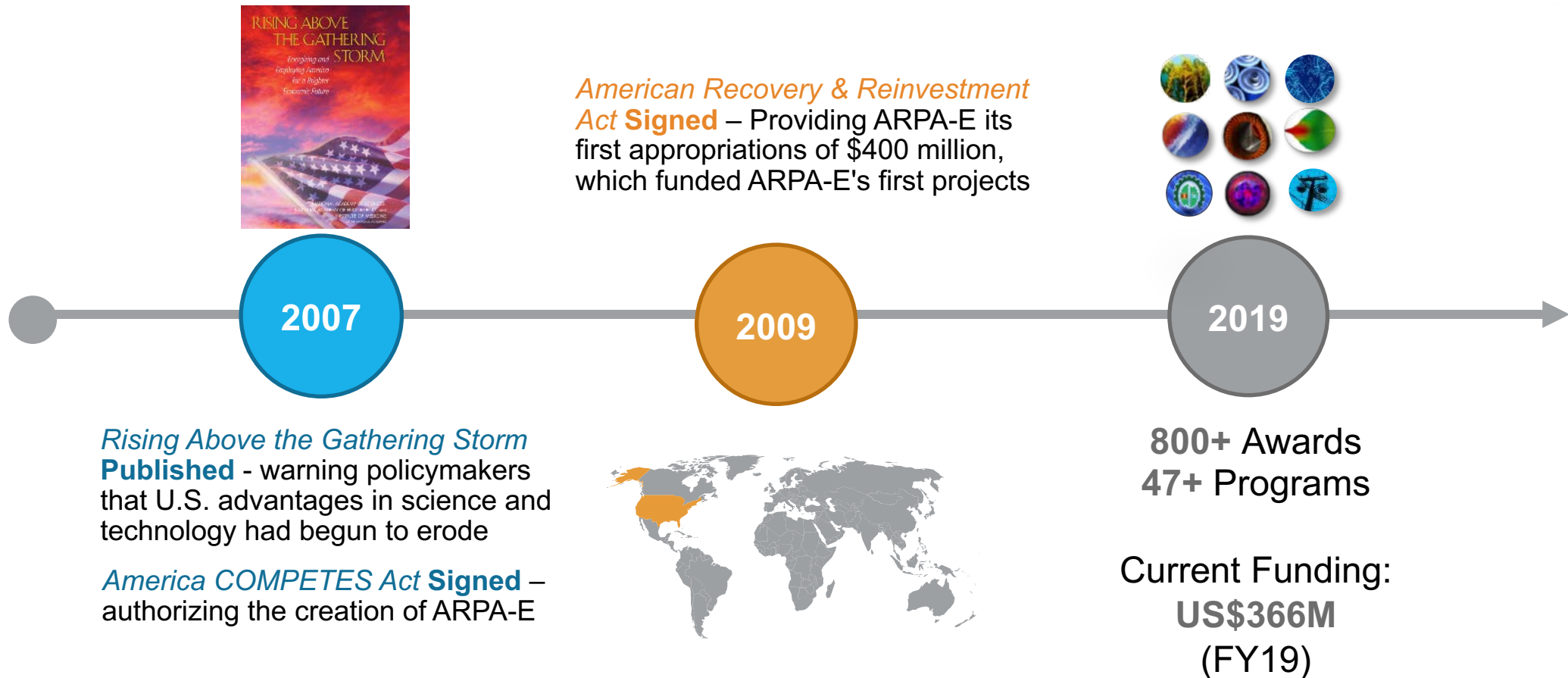



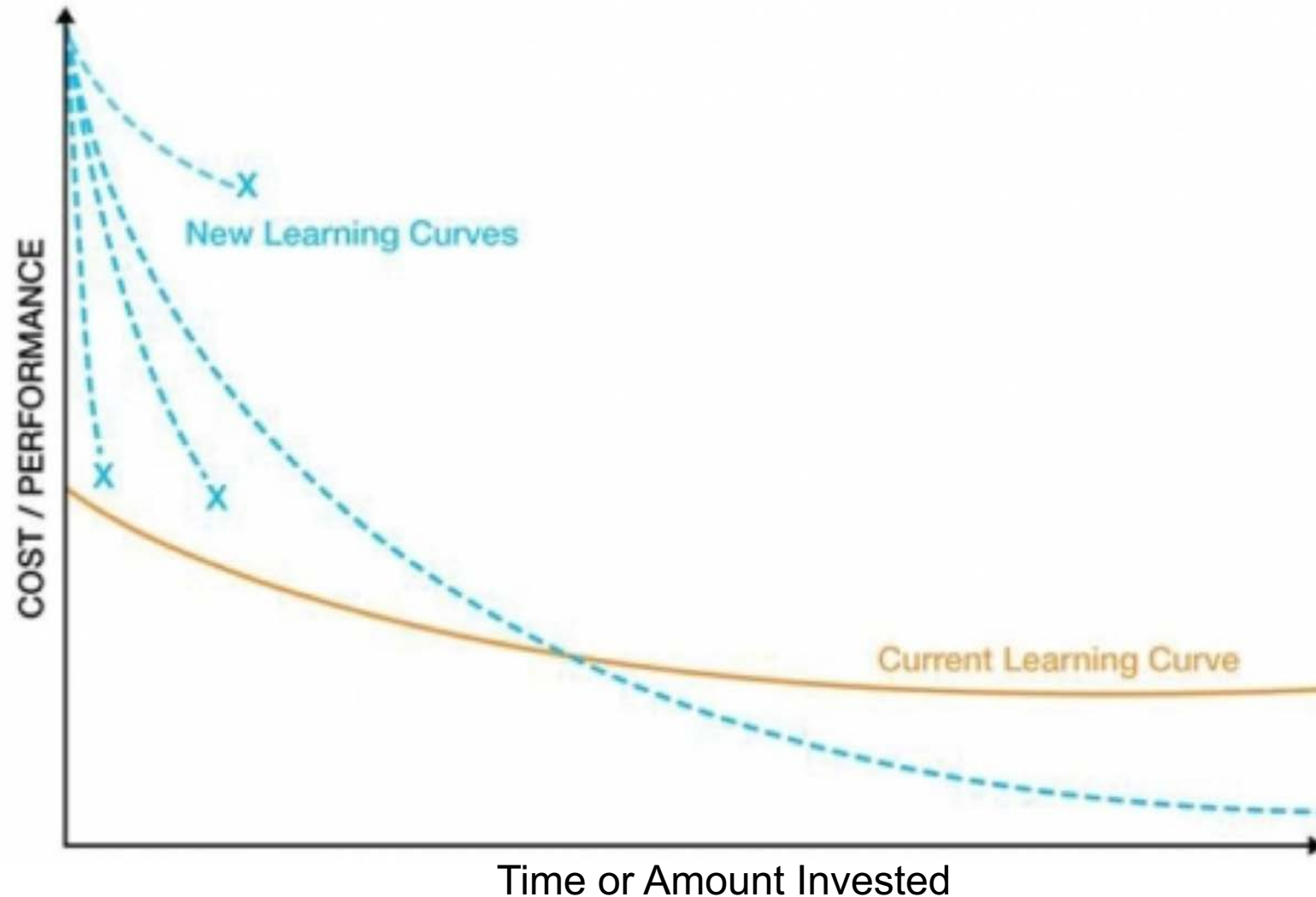



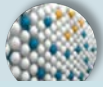

In 2007, The National Academies recommended Congress establish an Advanced Research Projects Agency within the U.S. Department of Energy to fund advanced energy R&D.

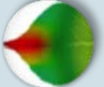

ARPA-E funds transformative, off-roadmap energy R&D with the goal of disrupting “current learning curves”

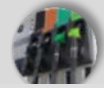

Limited-term program directors formulate, pitch, and execute “focused programs” that are each nominally 3 years, \$30M total

	ELECTRICITY GENERATION & DELIVERY	EFFICIENCY	TRANSPORTATION
Active	 INTEGRATE  GRID DATA  IONICS  MOSAIC	 SENSOR  CIRCUITS  PNDIODES	 MARINER  REFUEL
	 GENSETS  NODES  ALPHA	 ENLITENED  SHIELD  ROOTS	 NEXTCAR  TRANSNET
	 CHARGES  FOCUS  METINER	 MONITOR  ARID  DELTA	 TERRA  RANGE  REMOTE
Alumni	 REBELS  GRIDS  GENI	 SWITCHES  METALS	 MOVE  PETRO
	 HEATS  SOLAR ADEPT  IMPACCT	 BEETIT  REACT  ADEPT	 ELECTROFUELS  AMPED  BEEST

**OPEN 2009, 2012, 2015 & 2018 Solicitations
Complement Focused Programs**

ARPA-E aims to create a “mountain of opportunity” in transformative energy technologies

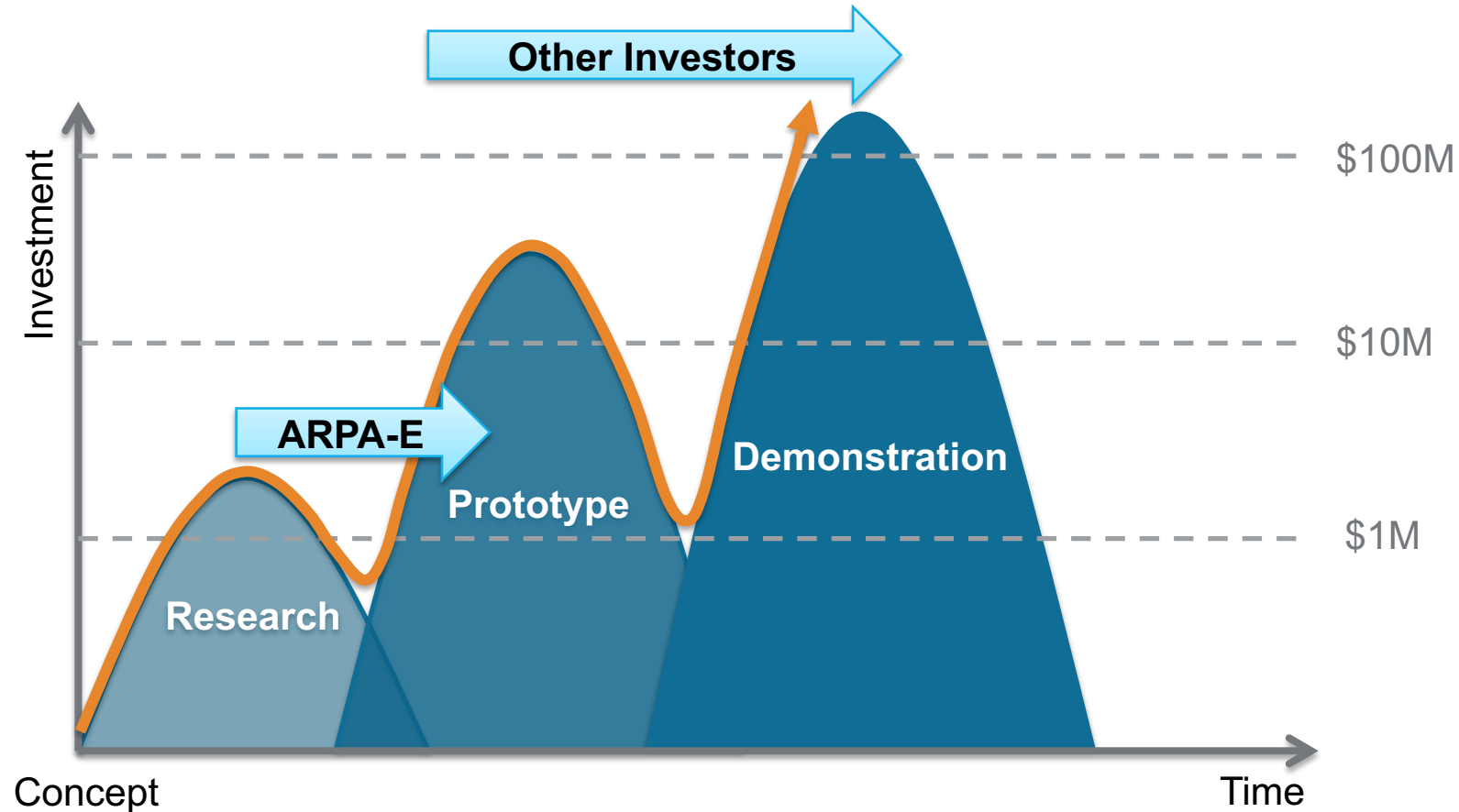

Public-private partnering is at the core of ARPA-E's mission and program formulation/execution

Metrics:

- ▶ Private-sector follow-on funding
- ▶ New company formation
- ▶ Partnership with other government agencies
- ▶ Publications, inventions, patents

Since 2009
ARPA-E has
provided

\$2 billion

in R&D funding to
more than **800 projects**



76 companies

formed by
ARPA-E
projects



131 projects

have **partnered**
with other
government
agencies
for further
development



145 Projects have
attracted more than

\$2.9 billion

in private-sector follow-on funding



2,489

peer-reviewed
journal articles
from ARPA-E
projects



346 patents

issued by U.S.
Patent and
Trademark Office



As of March 2019

What makes a good ARPA-E proposal/project?

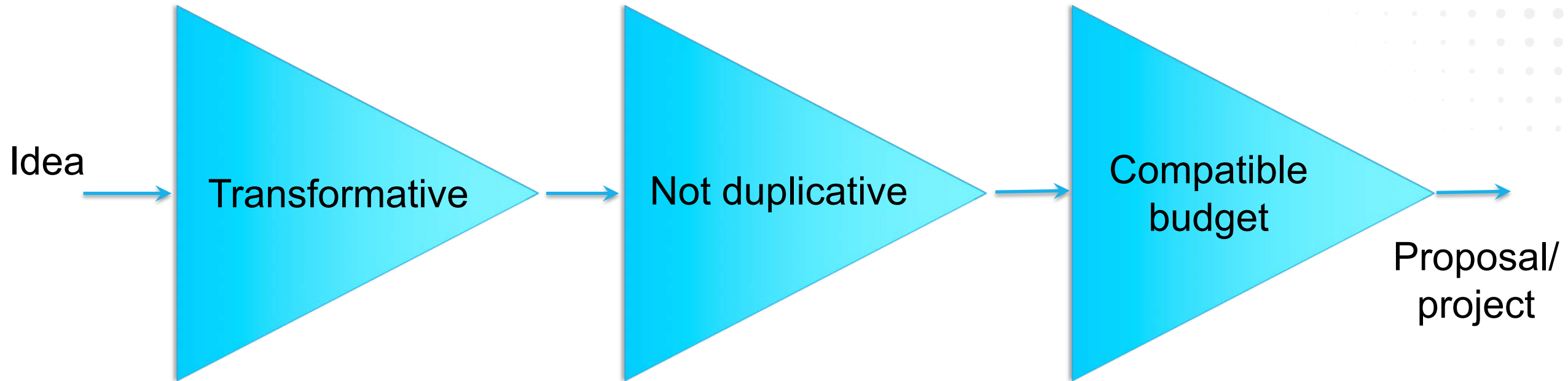

Potential to disrupt development trajectory based on present state-of-the-art projections

Impactful project result for $\leq \$10M$ (federal funds), ≤ 3 years that will catalyze further support/effort

Fusion must learn from fission: (1) lower the cost/complexity, (2) understand markets, (3) achieve regulatory certainty, and (4) earn public acceptance

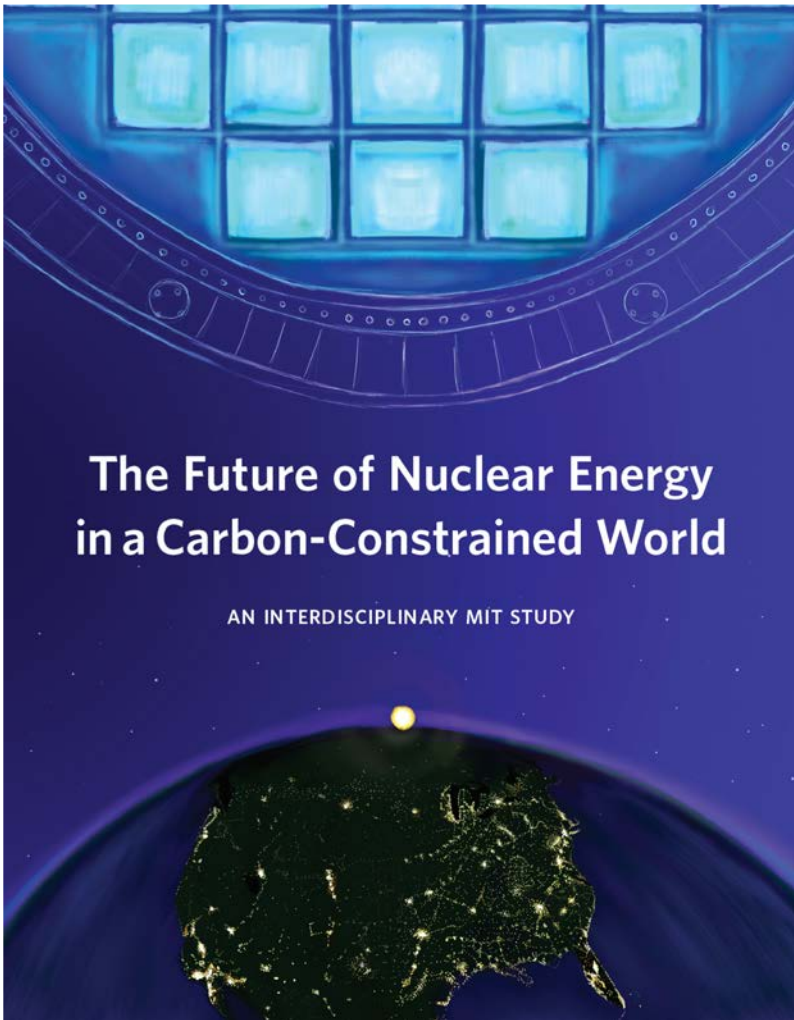

Nuclear Power in a Clean Energy System

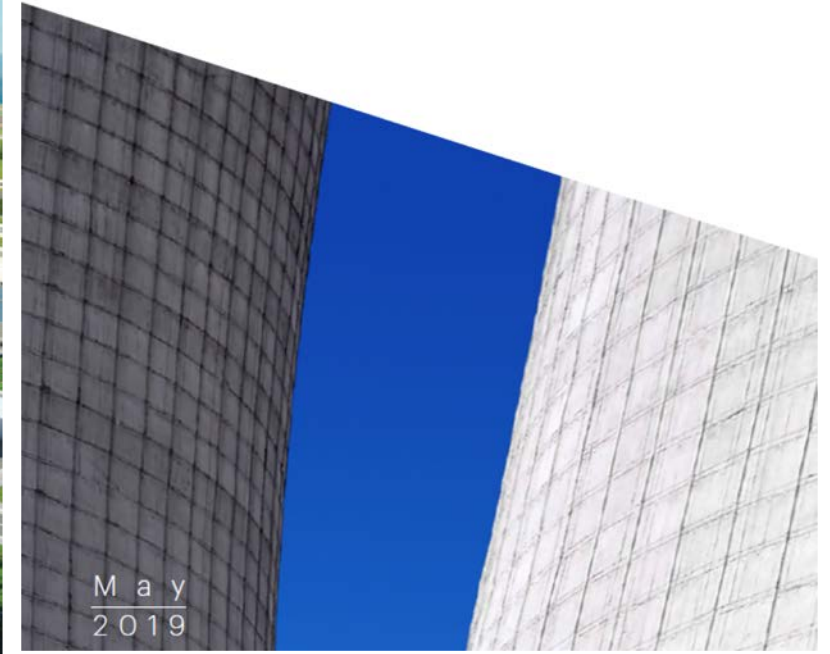

Markets/cost: One study suggests that, in 2030, ~465-GWe exist for fusion at >\$75/MWh, and ~2.7-TWe exist at <\$60/MWh

The likely addressable market for fusion in the 2030s amounts to ~465 GW globally, with a much bigger potential of ~2,720 GW if fusion can compete with fossil fuels below \$60/MWh

Total estimated addressable market for fusion (GW) at different price levels in a high electrification scenario

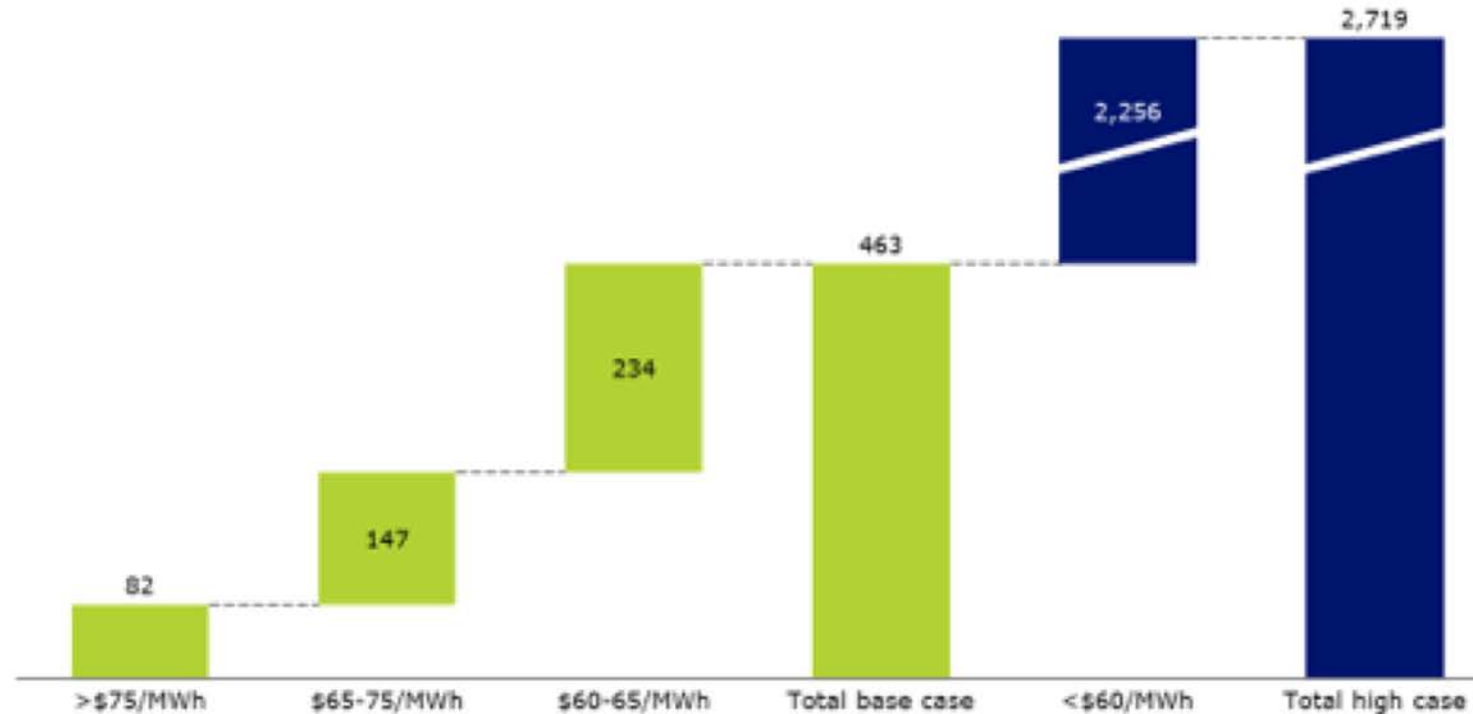

Examples:

- Alaskan village: [\\$400/MWh](#)
- DoD base: [\\$200/MWh](#)
- Singapore: [\\$130/MWh](#)
- Germany: [\\$60/MWh](#)
- Texas: [\\$3/MWh](#)

Firm power sources (i.e., meets demand over seasons and long duration) needed for cost-effective, low-carbon grid

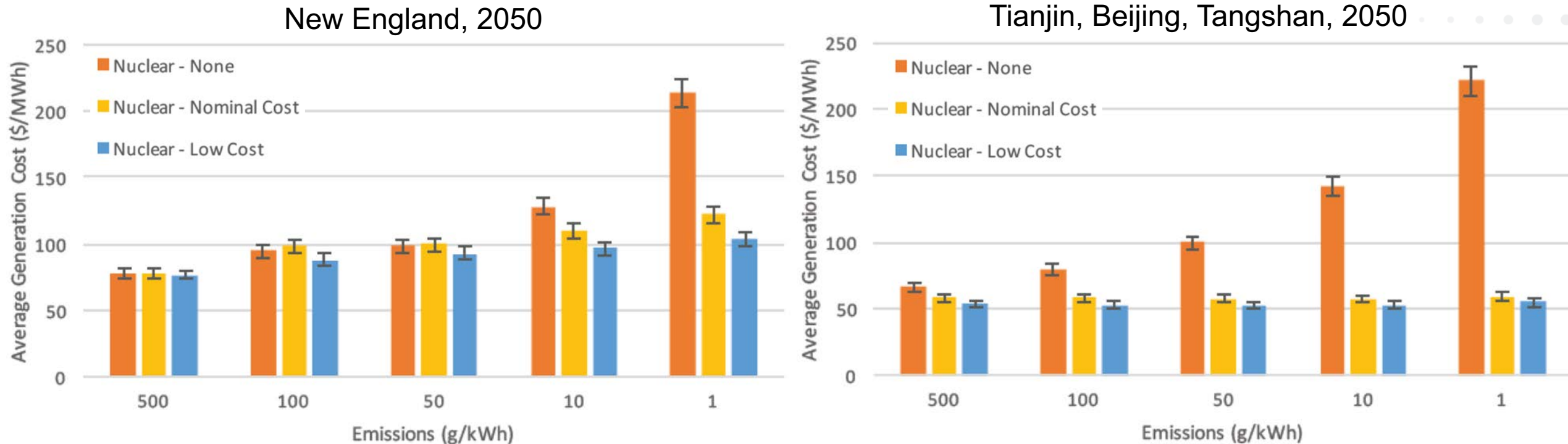

From [“The Future of Nuclear Energy in a Carbon-Constrained World, An Interdisciplinary MIT Study,” MIT Energy Initiative \(2018\)](#), p. 13.

Fusion programs at ARPA-E are informed but not overly constrained by market awareness

To impact 21st-century markets, fusion must be solved and adopted quickly.

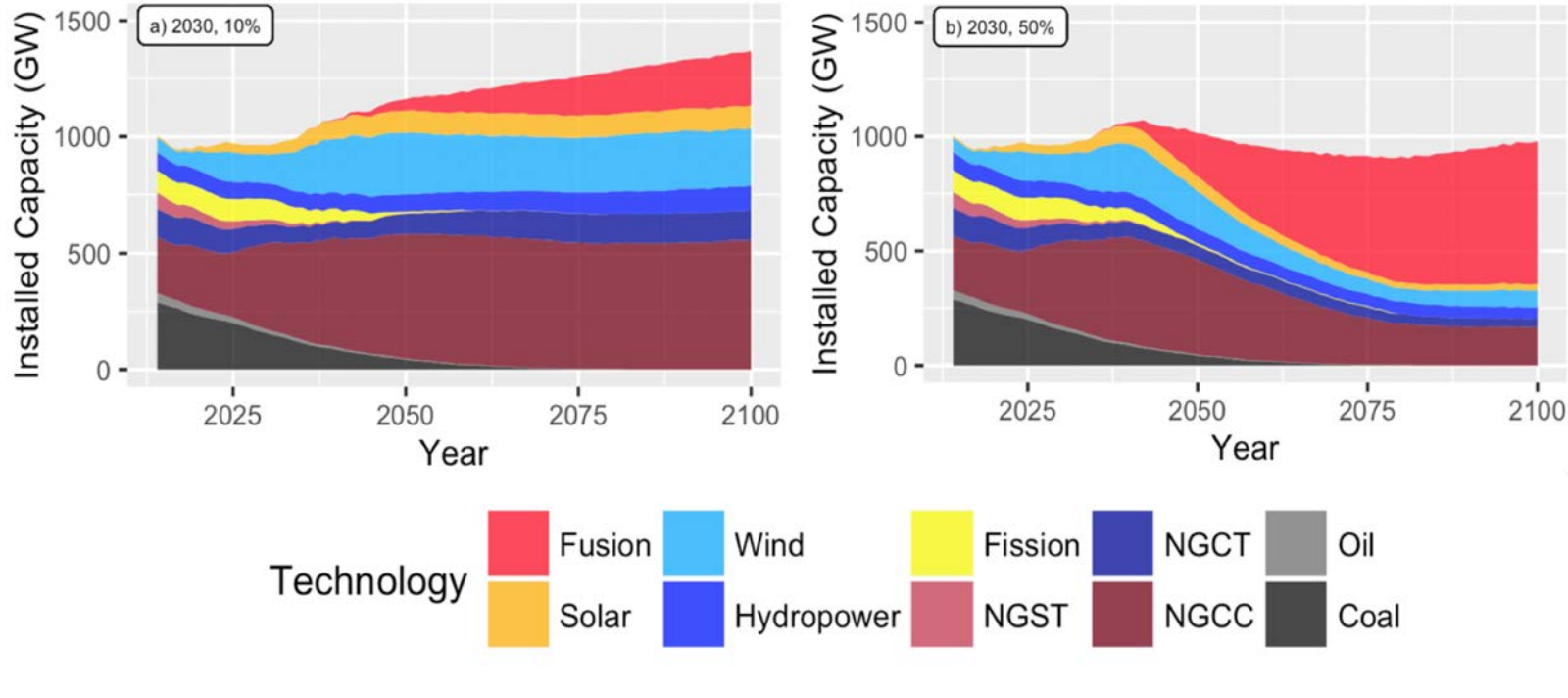

What capital cost is needed for a hypothetical zero-carbon, 100%-capacity-factor electricity source to be adopted quickly (i.e., to displace fossil fuels)?

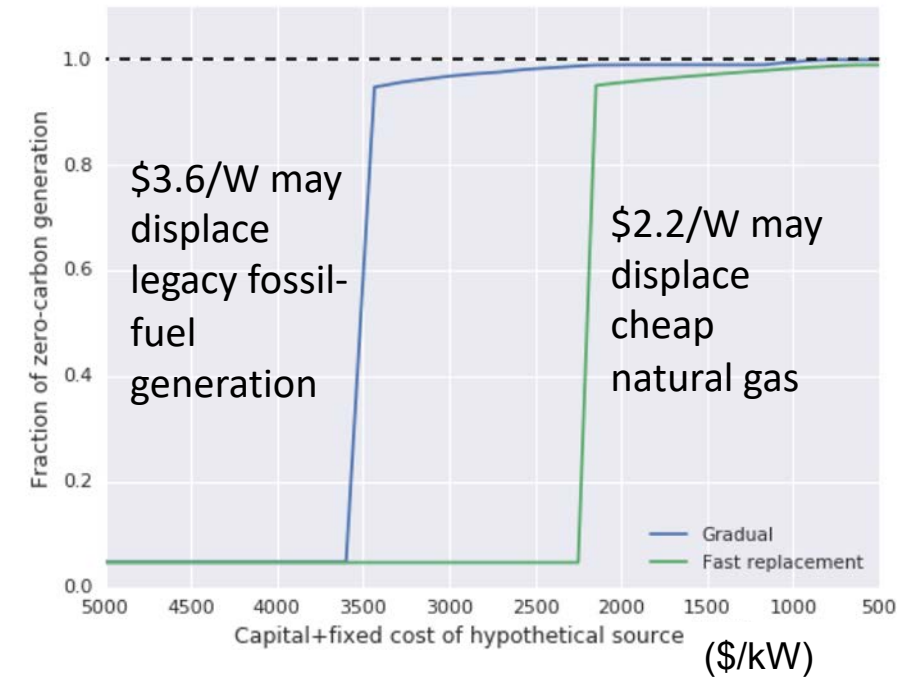

[L. Spangher, J. S. Vitter and R. Umstattd, "Characterizing fusion market entry via an agent-based power plant fleet model," Energy Strategy Reviews 26, 100404 \(2019\).](#)

Platt, John and Pritchard, J. Orion and Bryant, Drew, Analyzing Energy Technologies and Policies Using DOSCOE (August 8, 2017). Available at <http://dx.doi.org/10.2139/ssrn.3015424>.

Carbon tax of >\$50/ton could greatly expand the market for fusion (based on modeling of fission in competitive market)

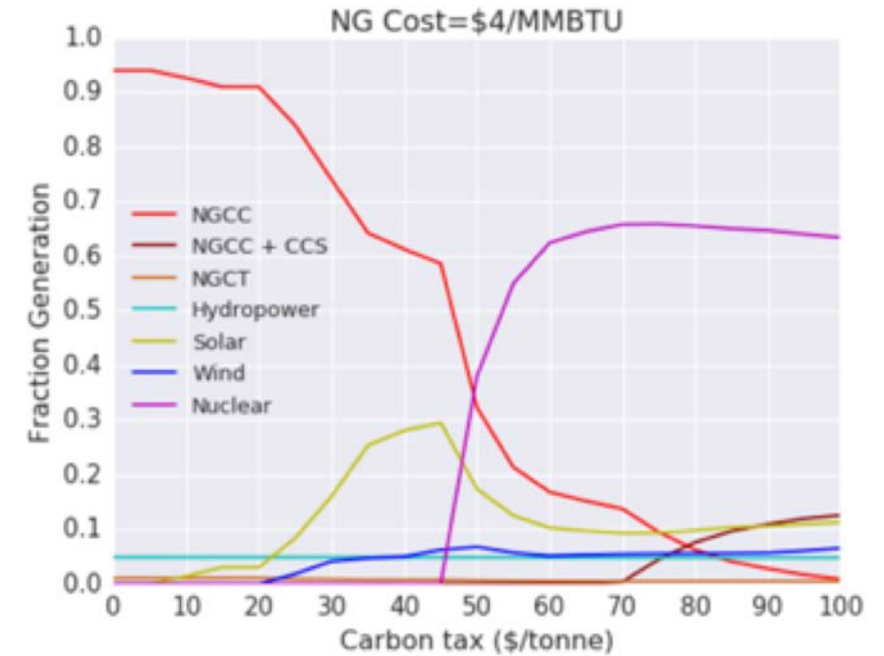
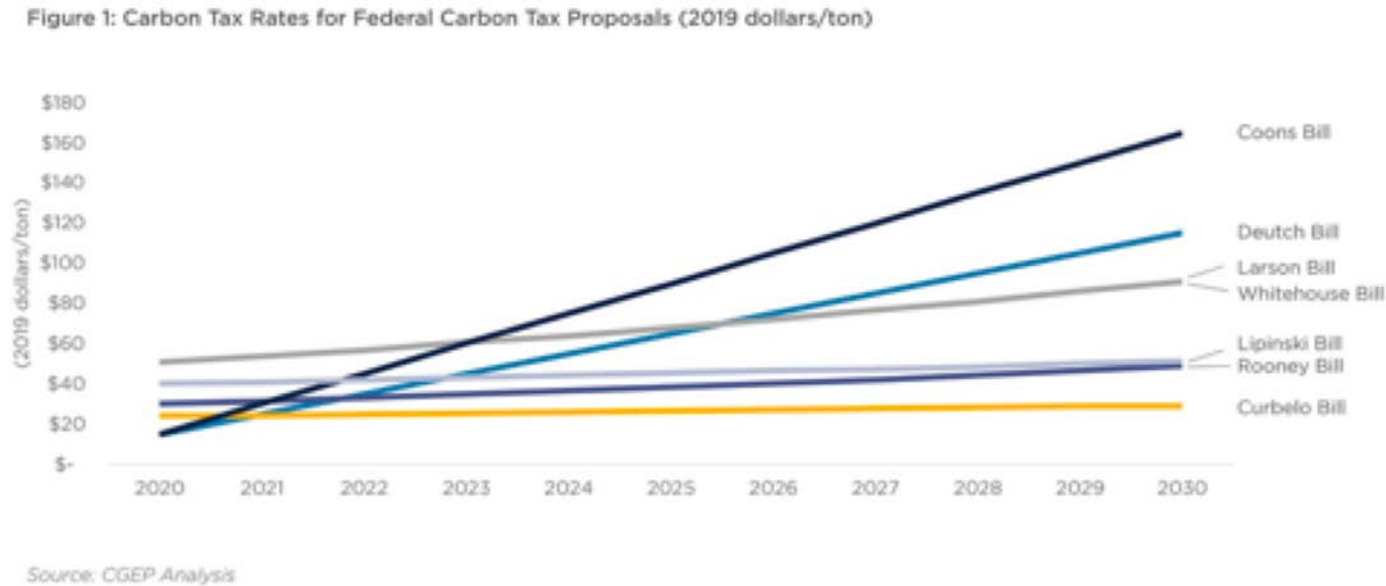

<https://twitter.com/noahqk/status/1157343492332539910>

[Analyzing Energy Technologies and Policies Using DOSCOE](#)

ALPHA focused on pulsed, magnetized, intermediate-density fusion (MIF and z-pinch variants) → lowers ignition requirements

Magnetic field dramatically reduces areal density (and therefore predicted facility cost) required for pulsed ignition

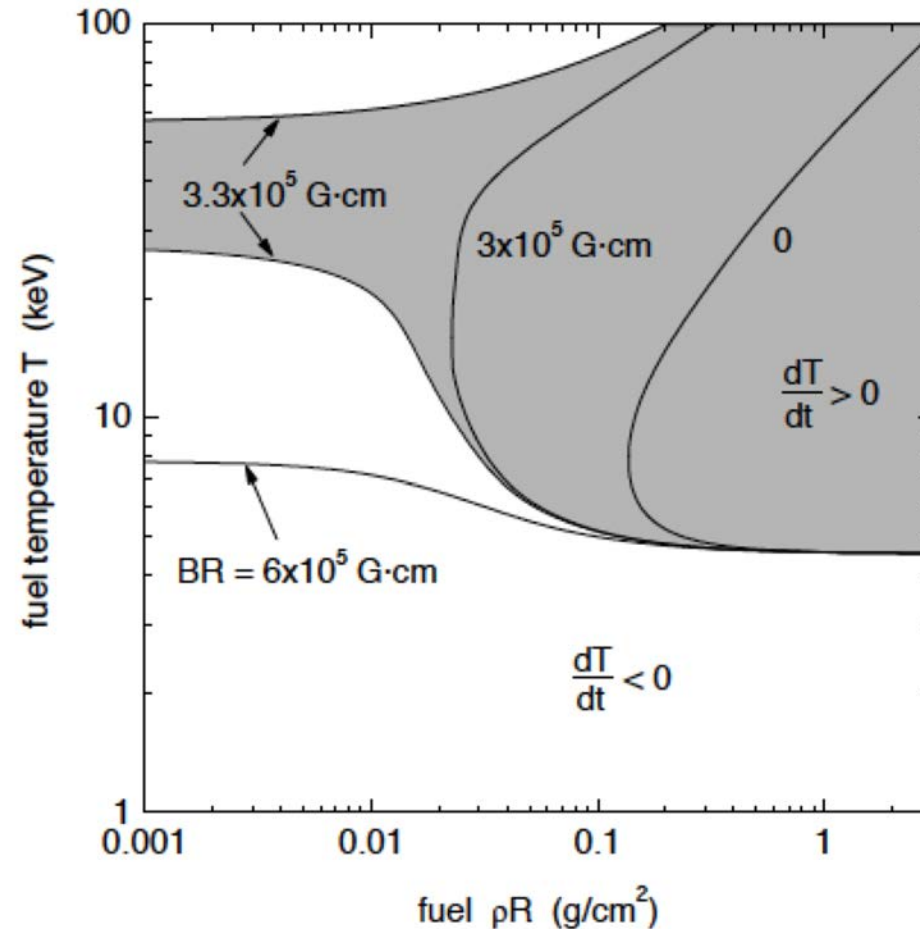

Fusion concepts studied within the ALPHA portfolio spanned ~6 orders of magnitude in fuel density

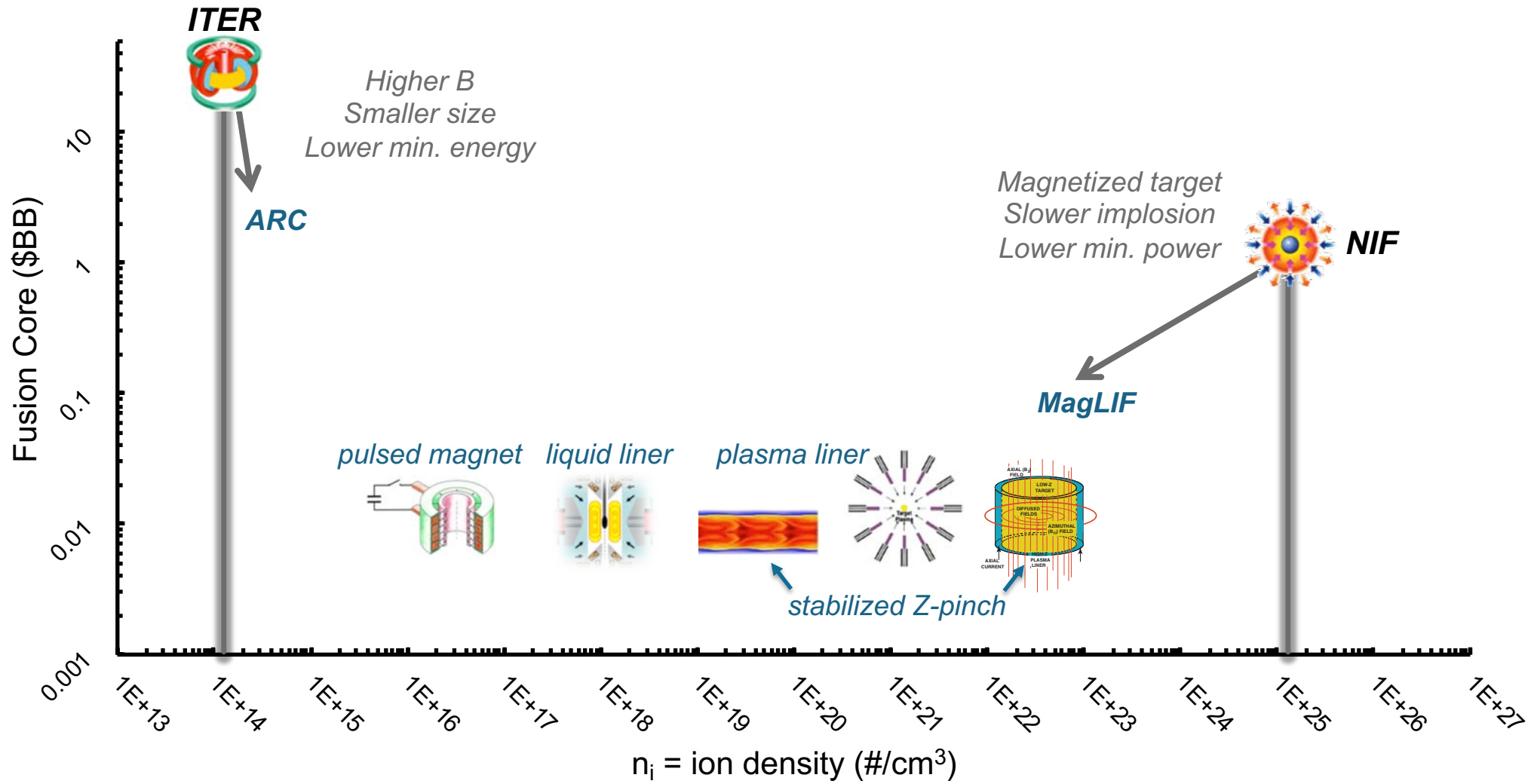

ALPHA concept: Sustained neutron production in a sheared-flow stabilized Z pinch, consistent with thermonuclear DD fusion

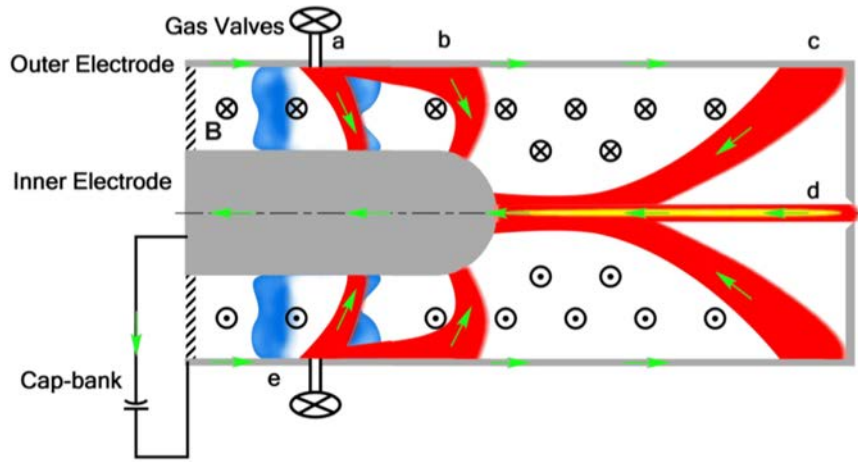

	n_i (m^{-3})	$T_e=T_e$ (keV)	τ_E (μs)	$nT\tau_E$ (keV s/ m^3)
Pre-ALPHA	$3e22$	0.075	5	$1e16$
ALPHA	$1e23$	~ 1.0	~ 5	$\sim 5e17$

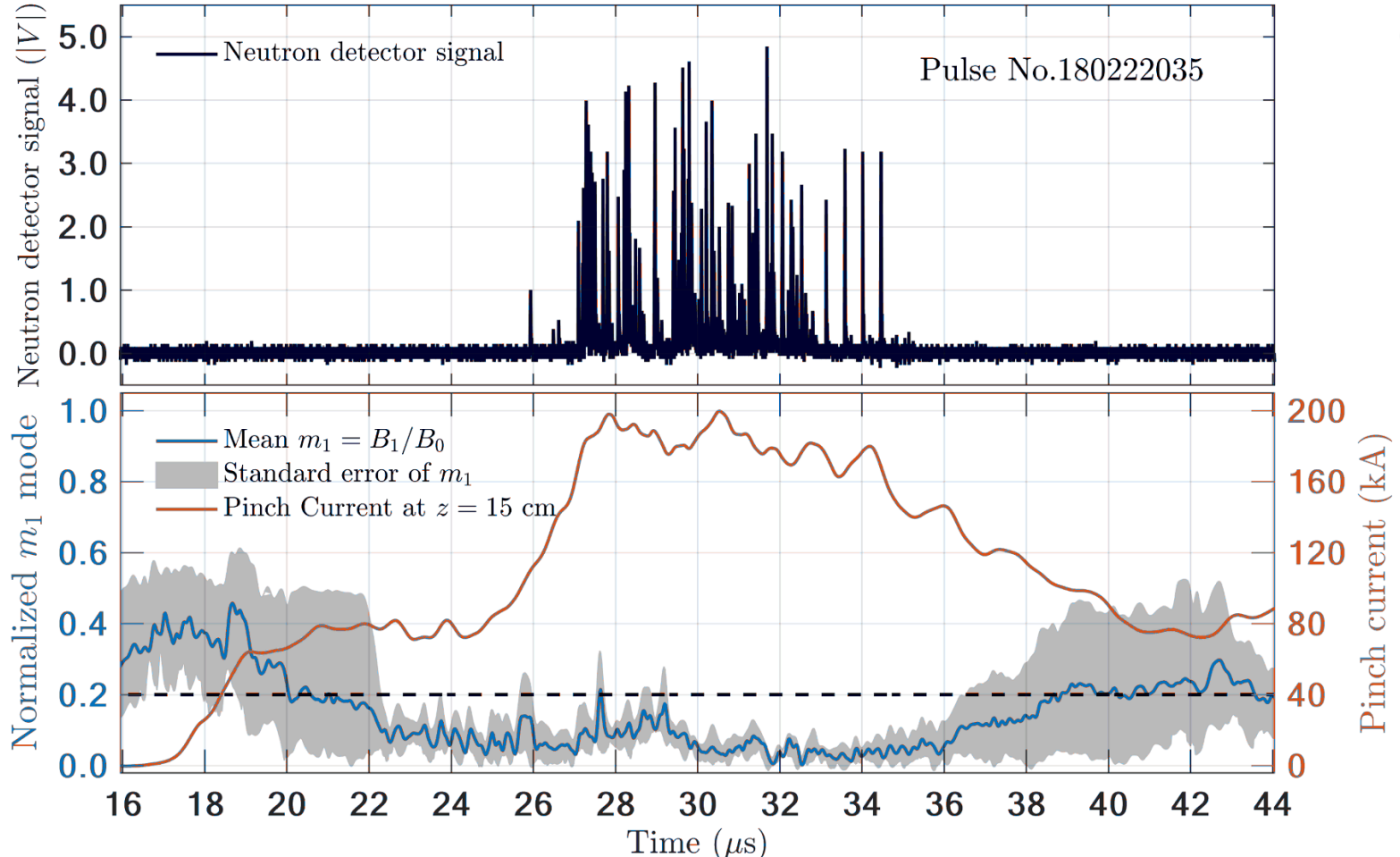

Follow-on: scale up to 600 kA and multi-keV temperatures by spin-out Zap Energy (ARPA-E OPEN 2018 program)



UNIVERSITY of WASHINGTON



U. Shumlak et al., [Phys. Plasmas 24, 055702 \(2017\)](#)
 Y. Zhang et al., [PRL 122, 135001 \(2019\)](#)

ALPHA applied science: Development of the OMEGA “mini-MagLIF” platform to explore MIF science at fusion conditions

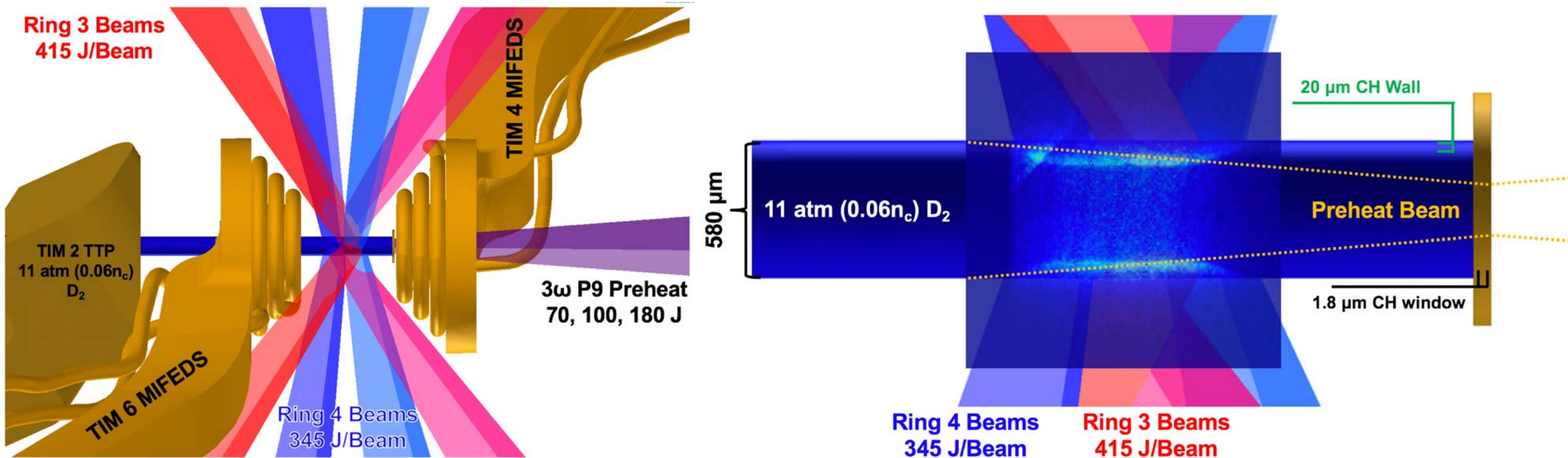

With axial field and laser pre-heat, $T_i > 2.5$ keV, $Y_{DD} > 10^{10}$ neutrons



ALPHA drivers: demonstration of two new potential MIF drivers, MEMS ion accelerator and plasma guns with preionization

Compact, low-cost, high-power ion beams

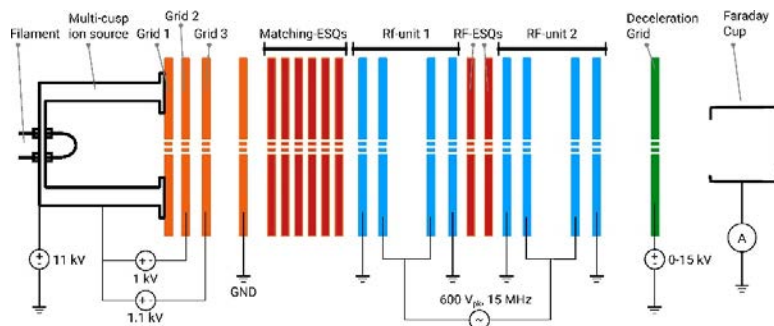
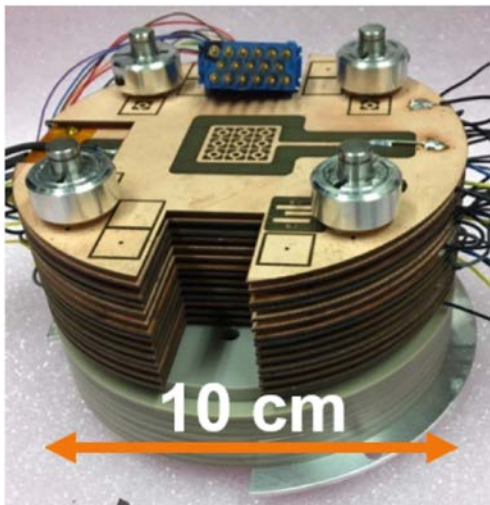

Demonstrated 2.6 kV/gap, 10.2 kV, 3×3 beam array

Follow-on: scale up to 1 MV/m and >100 mA (ARPA-E OPEN 2018 program)

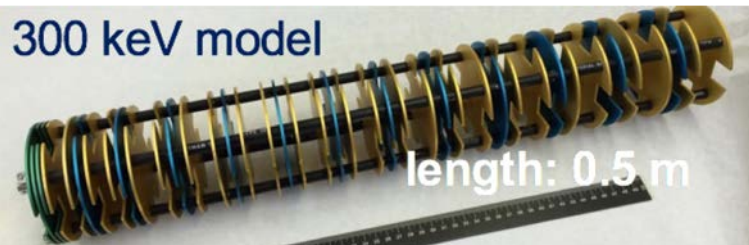

Plasma guns for plasma-liner formation via merging plasma jets

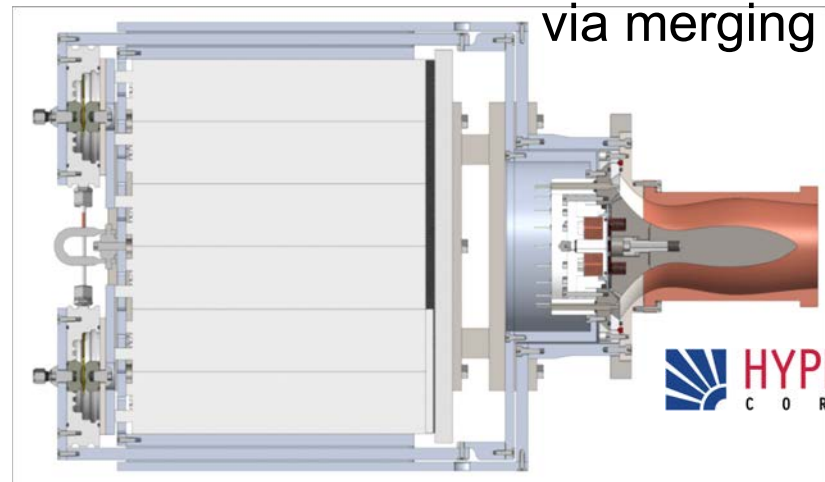

1 mg mass
50 km/s
>10¹⁶ cm⁻³



~80 cm

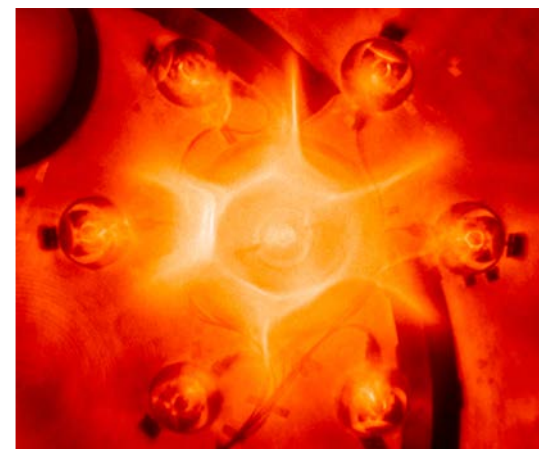

LBNL: P. Seidl et al., [Rev. Sci. Instrum. 89, 053302 \(2018\)](#)

LANL/HyperJet: S. C. Hsu et al., [IEEE Trans. Plasma Sci. 46, 1951 \(2018\)](#); Y. C. F. Thio et al., [Fus. Sci. Tech. \(2019\)](#).

ALPHA concept: Stable staged-Z-pinch implosions at $B_{z0} > 1.5$ kG and DD neutron production on the 1-MA Nevada Terawatt Facility

Kr gas-puff liner gave the best results

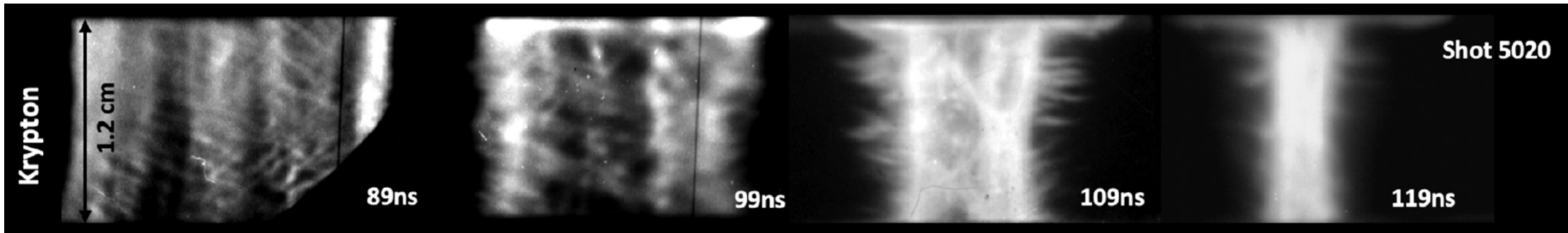
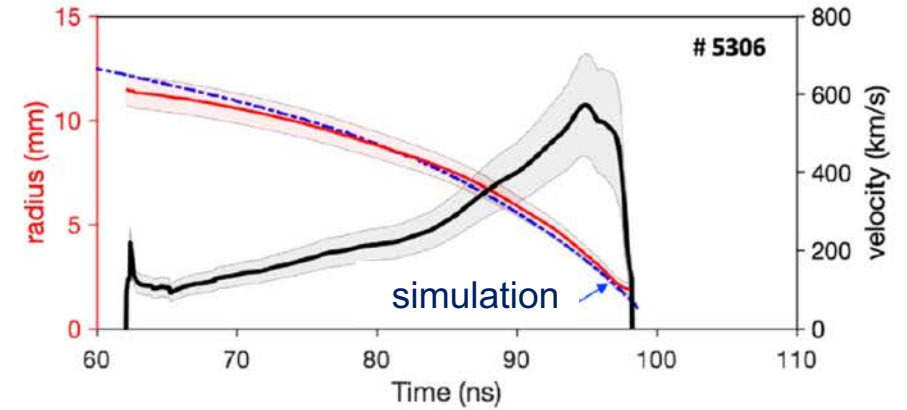
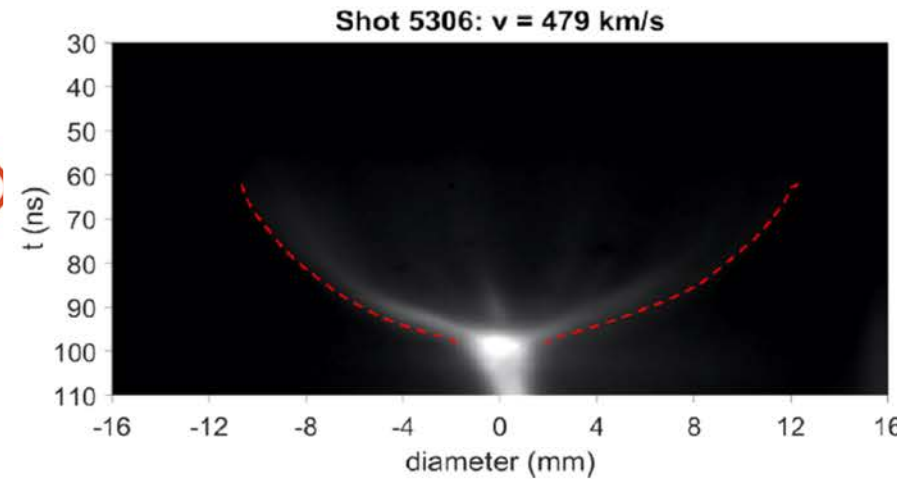
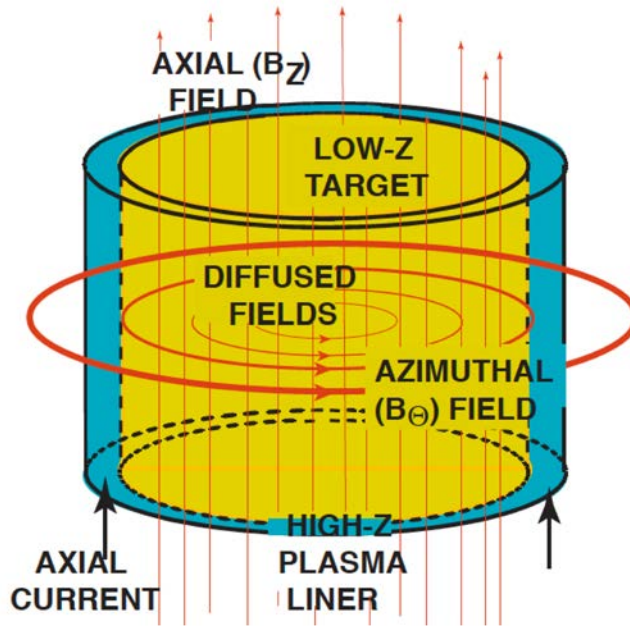

ALPHA applied science: Acceleration and compression studies of a helically relaxed Taylor state as a potential MIF target

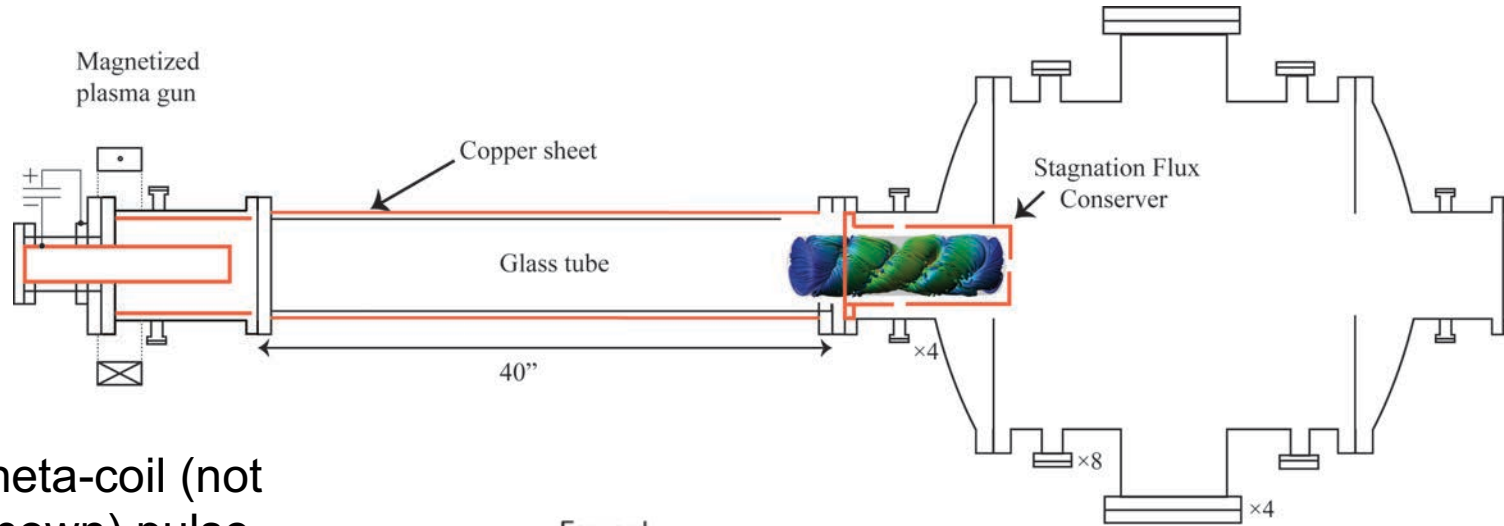

Theta-coil (not shown) pulse generated super-thermal and super-Alfvénic waves rather than effective acceleration of the plasma

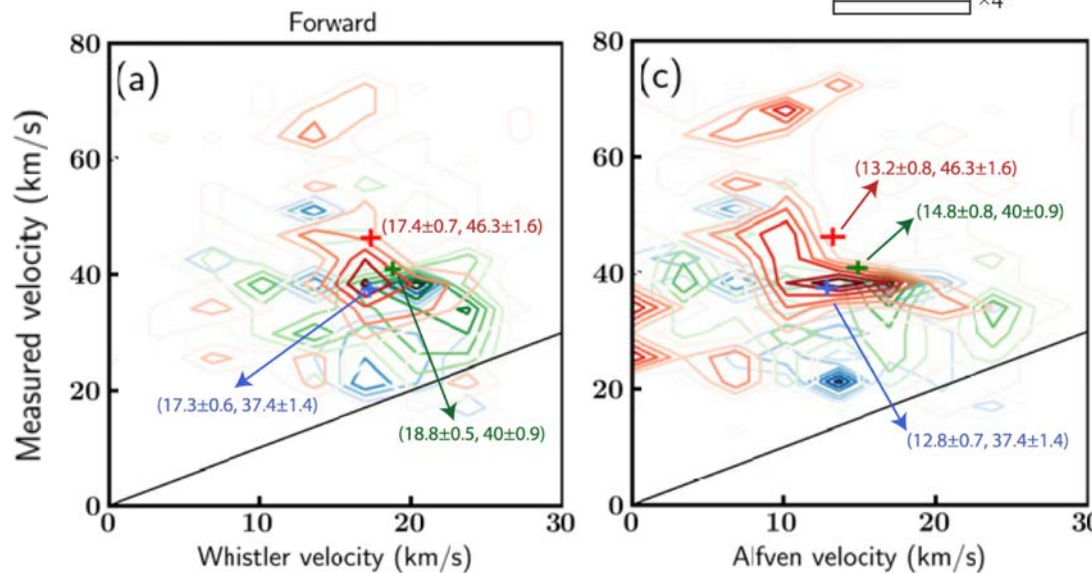

Equation of state during compression suggests better agreement with parallel CGL compared to MHD or perpendicular CGL

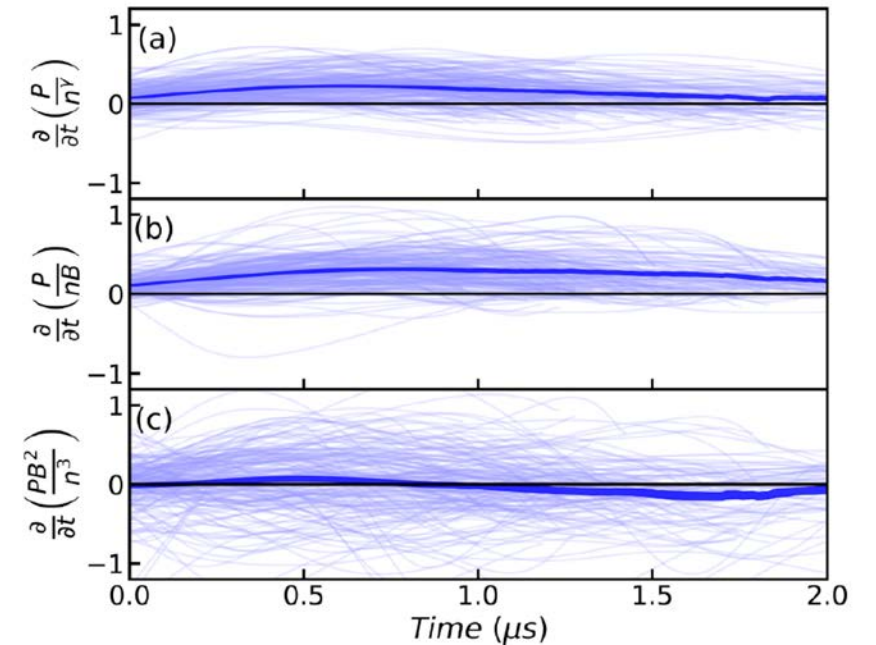

Ongoing work: merging of two Taylor-state plasmas to increase density

ALPHA applied science: Fundamental studies of plasma compression and heating

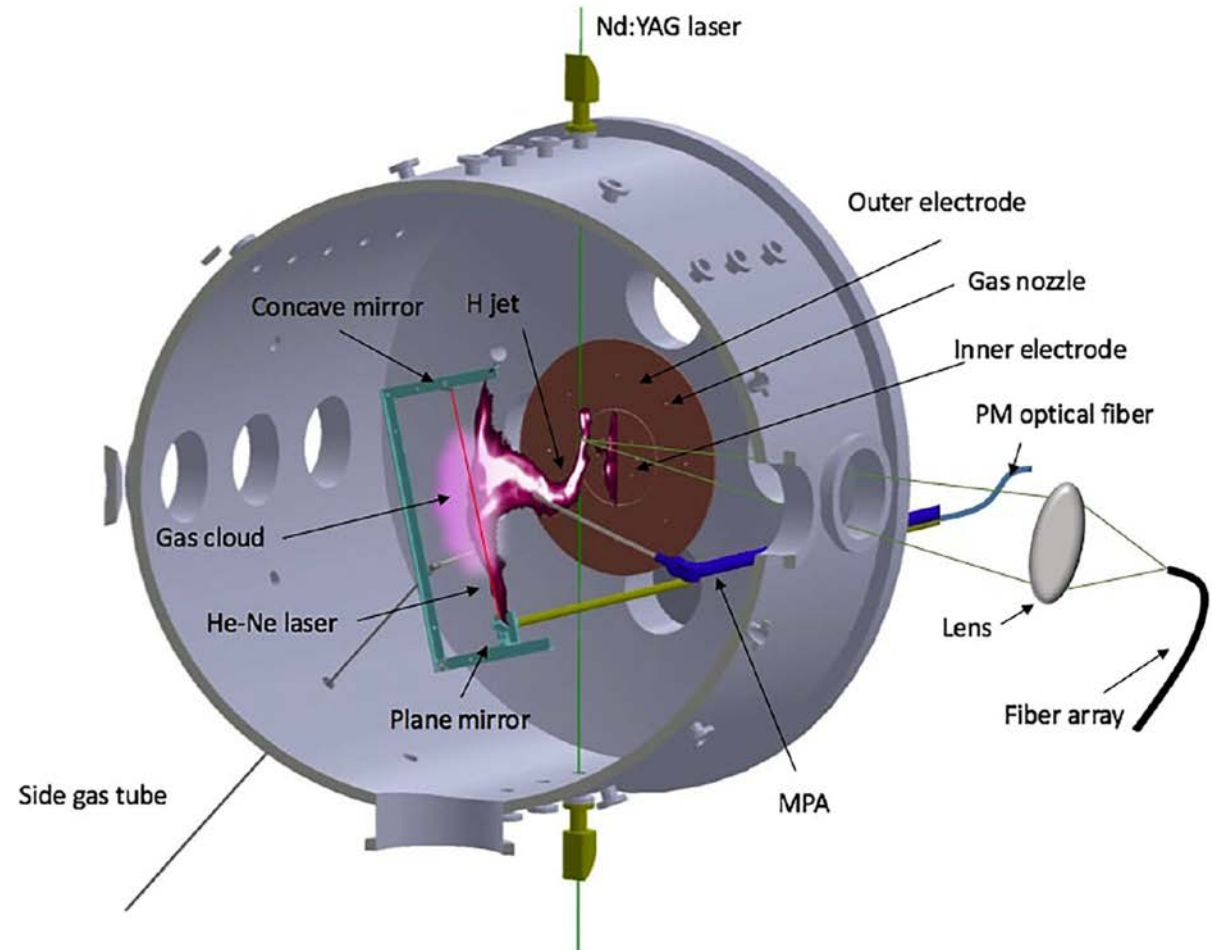
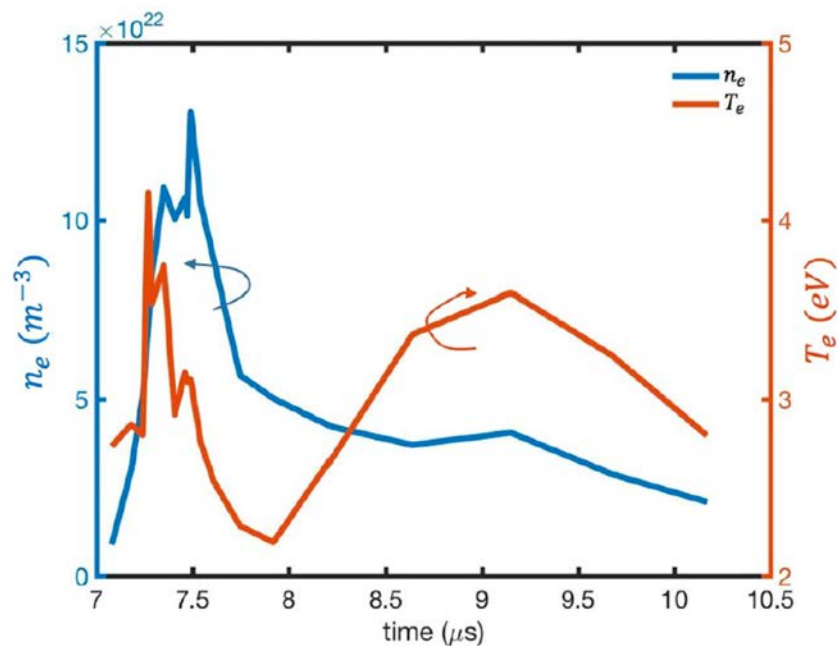
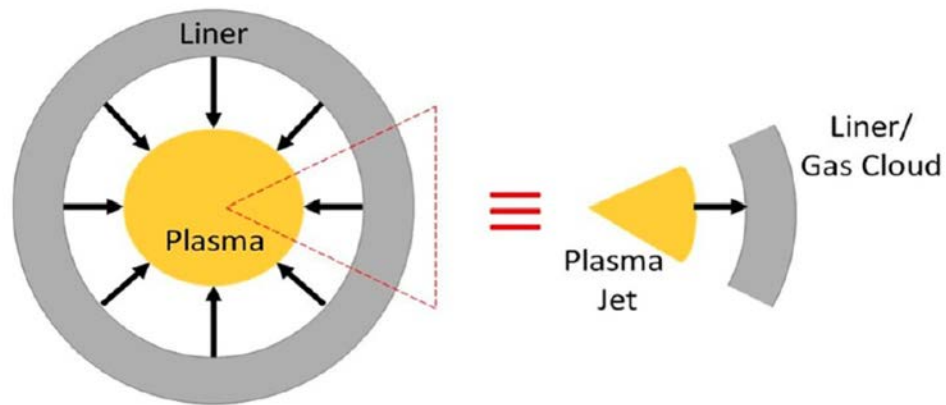

Other ALPHA projects (concept and driver)

- ▶ Helion Energy: magnetic compression of FRCs formed by dynamic merging
 - Construction of “Fusion Engine Prototype” (FEP) device
 - Increased the magnitude of compression-magnetic-field strength and FRC flux
 - Advancing the plasma parameters of the compressed FRC
 - Generation and measurement of DD neutrons
- ▶ NumerEx: Design of stabilized, rotating, imploding liquid liner
 - 1-km/s implosion speed using annular pistons
 - Developed engineering design of a system using NaK with 10-cm-diameter bore
 - Did not construct the system due to challenges with high-pressure valves and triggering

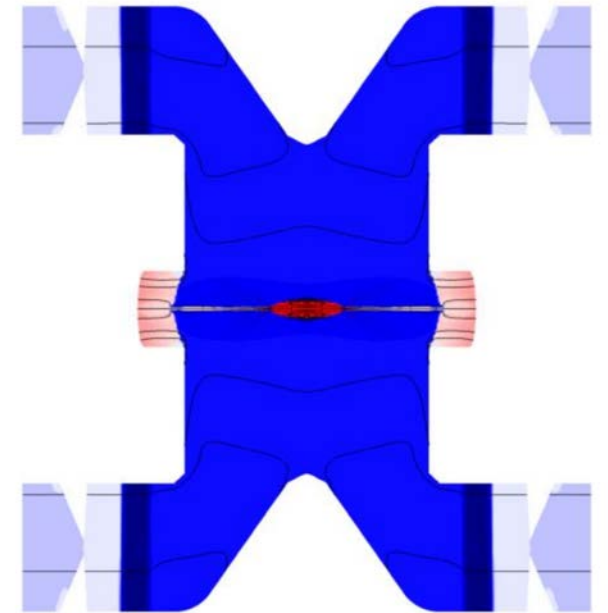

ALPHA's tech-2-market (T2M) component helped its teams with IP analysis, costing, and understanding fusion market entry

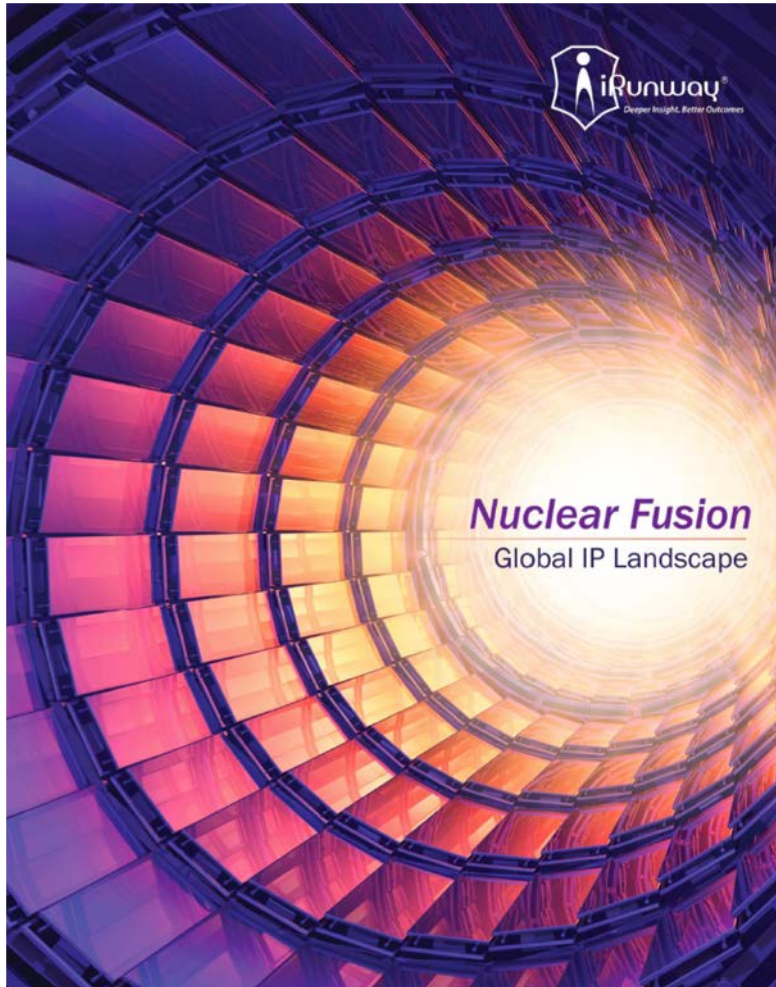

Stabilized Liner Compressor Plasma Jet Driven Magneto-Inertial Fusion

Staged Z-Pinch Sheared Flow Stabilized Z-Pinch

Conceptual Cost Study for a Fusion Power Plant Based on Four Technologies from the DOE ARPA-E ALPHA Program

Bechtel National, Inc.
Woodruff Scientific, Inc.
Decysive Systems

February 2017

BECHTEL Bechtel National, Inc.
Report No. 26029-000-30R-G016-00001



Characterizing fusion market entry via an agent-based power plant fleet model

Lucas Spangher^{a,*}, J. Scott Vitter^{b,1}, Ryan Umstadd^b

^aU.S. Department of Energy Advanced Research Projects Agency - Energy (ARPA-E), USA
^bThe University of Texas at Austin, USA

ARTICLE INFO

Keywords:
Agent-based modeling
Fusion energy
Power plant
Green new deal

ABSTRACT

An agent based model characterizing the U.S. power plant fleet was formulated to compare scenarios for fusion energy technology diffusion. The model employs historical data to form distributions for power plant retirements, and simulates construction of new capacity to meet electricity demand on an annual basis. Scenario analysis within this paper explores model sensitivity to 1) the year of market entry for commercial fusion technologies, 2) rate of diffusion, and 3) market capture limit. Results indicate that the first-decade market potential for fusion power plants depends on retirements of other generating resources and finds that near-term availability of fusion technology has limited potential to mitigate fleet-wide emissions in the near term, even at high rates of market capture.

1. Introduction

The electric power sector is a major source of greenhouse gas (GHG) emissions in the United States, contributing 29% of all GHG emissions in 2015, ahead of transportation (27%) [1]. To achieve deep decarbonization across the entire economy, the electricity sector must eventually shift to near-zero emission generation technologies. Nuclear fusion has been proposed as a potentially transformational technology to provide abundant, sustainable, reliable, and carbon-free electricity generation [2]. In a fusion reaction, nuclei combine in an exothermic reaction, giving off heat that can be the source for a thermal power plant [28]. Several fusion fuel cycles have been researched, and they share many potential advantages: The hydrogen isotope deuterium (2H) is naturally occurring; reactors can be engineered to breed additional tritium (3H) to fuel future reactors; waste streams from fusion byproducts will be less hazardous than nuclear fission byproducts; operational risk can be greatly reduced relative to nuclear fission; and fusion power plants have the potential to operate reliably and controllably [2]. To be acceptable to electric utilities, fusion power plants must meet several key criteria including low electricity costs, public acceptance, and a simple regulatory review process [3]. Even with early commercialization of fusion technology, however, altering the composition of the generating fleet could be difficult [4]. Capital requirements for new power plants are high, and new power

plants typically operate for decades. The electricity sector's technological inertia is exemplified by the capacity-weighted average lifetime of domestic power plants, which in 2016 was approximately 54 years [5]. Given these barriers, this paper addresses how the generation fleet in the US might evolve if fusion energy achieves technical feasibility and public acceptance. An agent-based model was built to represent the U.S. power plant fleet on a granular level, using historical data for power plant lifetimes, retirements, and future projections for electricity demand. Parameters including year of entry, diffusion rate, and fraction of annual market capture are varied to determine their influence on the future composition of the generation fleet and the trajectory of carbon emissions from the power sector from 2017 to 2100. To characterize the impact of technological breakthrough in fusion, market entry scenarios begin in 2030. Overall, modeled scenarios suggest upper bounds for installed capacity and carbon emission reductions attributable to fusion energy. In the U.S., recent policy discussions motivate our work. The Green New Deal (GND) has generated momentum to enact decarbonization policies in many energy sectors, including electricity. For electrical power, the GND calls for "meeting 100% of the power demand in the U.S. through clean, renewable, and zero-emission energy sources." [6] We outline scenarios in this paper that, in part, consider the effects of such a policy being passed. For this reason, we believe our paper is uniquely relevant to current policymakers and helps assess the

* Corresponding author. Currently at the University of California, Berkeley, USA.
E-mail addresses: lucas_spangher@berkeley.edu (L. Spangher), scott.vitter@utexas.edu (J.S. Vitter), Ryan.Umstadd@hq.doe.gov (R. Umstadd).
¹ These two authors are co-first author.

<https://doi.org/10.1016/j.esr.2019.100404>
Received 2 January 2018; Received in revised form 12 April 2019; Accepted 12 August 2019
2211-467X/ Published by Elsevier Ltd. This is an open access article under the CC BY-NC-ND license (<http://creativecommons.org/licenses/by-nc-nd/4.0/>).

JASON summer study (2018) was commissioned by ARPA-E to review the ALPHA program

▶ Statement of work:

- Assess progress of ALPHA and non-ALPHA MIF teams toward realizing low-cost fusion
- Assess future needs to realize low-cost MIF

▶ Abbreviated findings:

- MIF is physically plausible and rapid progress has been made despite having received ~1% funding of MCF and ICF; best performing system (MagLIF) is within a factor of 10 of scientific breakeven
- Pursuit of MIF could lead to valuable spinoffs, e.g., fusion propulsion
- MIF could absorb significantly more funding than ALPHA

▶ Main recommendations:

- Investments to study plasma instabilities, transport, liner-fuel mix at MIF conditions
- National Labs should contribute unclassified codes and user training
- Develop components, e.g., plasma guns, pulsed power, diagnostics, advanced magnets, and materials
- Near-term goal/priority should be scientific breakeven in a system that scales plausibly to a commercial power plant
- Support all promising approaches as long as possible; do not concentrate resources on early frontrunners

New fusion projects funded by ARPA-E OPEN 2018 program (represents expansion beyond MIF/Z-pinch-based concepts)

[Zap Energy/UW](#) (\$6.8M, continuation of UW/LLNL ALPHA project)

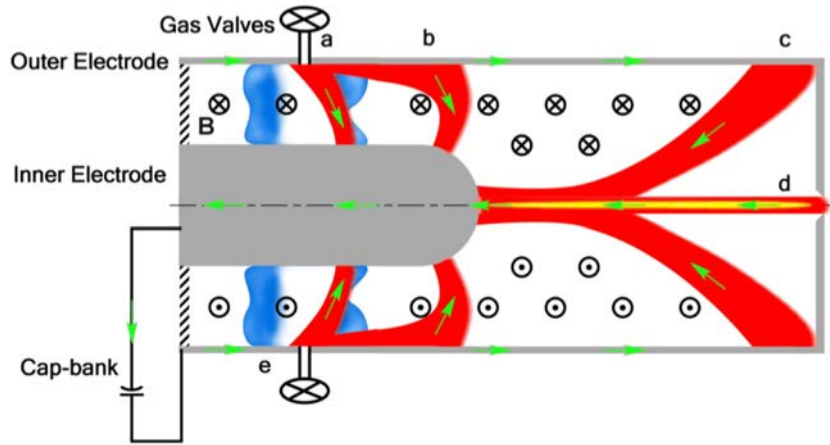

[CTFusion/UW](#) (\$3M, spheromak sustained by imposed dynamo current drive)

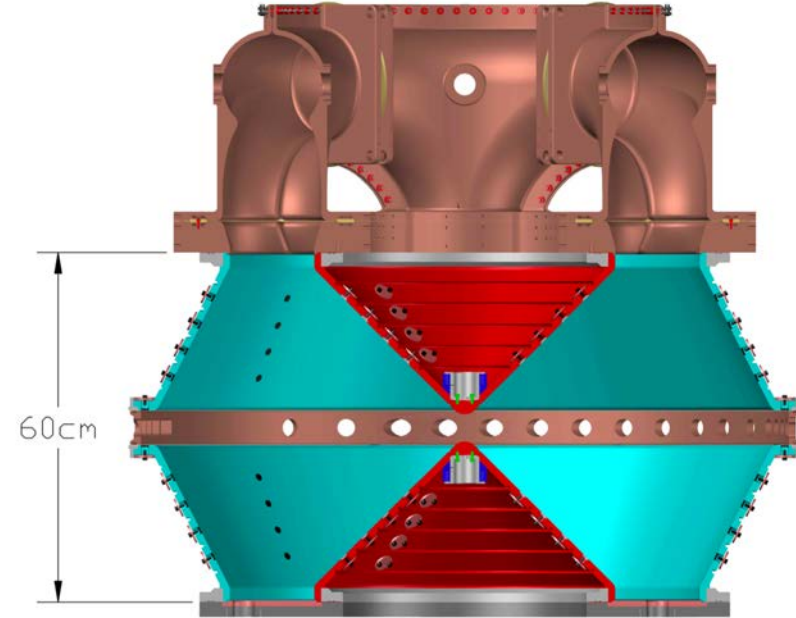

[Princeton Fusion Systems/PPPL](#)
(\$1.25M, FRC sustained/heated by odd-parity rotating magnetic field)

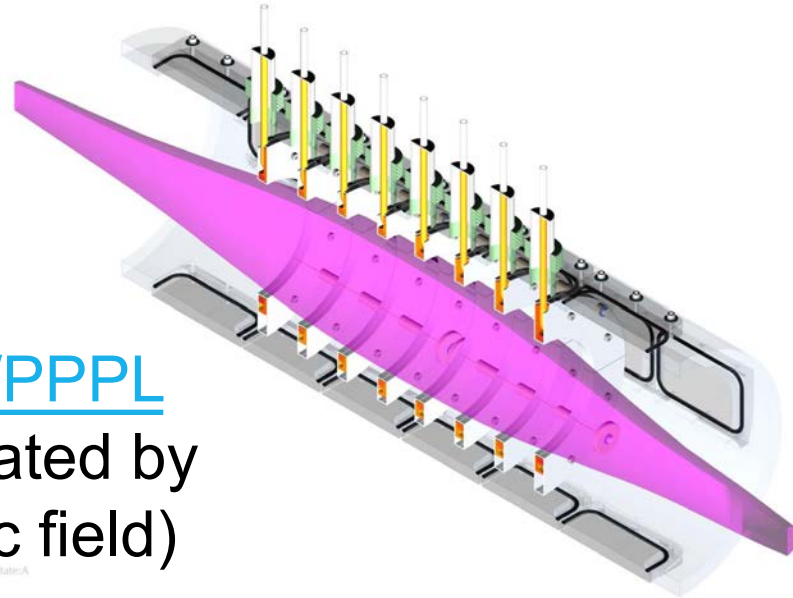

Diagnostic resource teams to support the validation of ARPA-E-supported fusion concepts (\$7.3M, 2 yrs.)

Eight teams [selected](#) (July, 2019):

- ▶ ORNL, \$1.1M, Thomson scattering (low density) and visible emission spectroscopy
- ▶ LLNL, \$2M, Thomson scattering (high density)
- ▶ LLNL, \$1.3M, neutron activation and nTOF detectors
- ▶ Univ. of Rochester/LLE, \$1M, neutron activation and nTOF detectors
- ▶ UC, Davis, \$444k, ultra-short-pulse reflectometry
- ▶ PPPL, \$450k, passive charge-exchange ion energy analyzer
- ▶ LANL, \$630k, filtered, time-resolved soft-x-ray imager
- ▶ Caltech, \$400k, hard x-ray imaging, non-invasive B-field assessment

RFI on enabling technologies for a commercially viable fusion power plant

Recent ARPA-E Request for Information (RFI) on Enabling Technologies for a Commercially Viable Fusion Power Plant

- ▶ Fusion market entry may require reduced nameplate capacity and capital cost compared to traditional fusion reactor cost studies (typically 1 GWe and >US\$5B)
- ▶ Fusion power plants at reduced scale and cost likely will have different technology requirements
- ▶ Interest in:
 - Thick, liquid blankets (e.g., molten salts or liquid metals)
 - Corrosion-resistant, high-temperature materials
 - Smaller tritium-processing systems and minimum tritium inventory
 - Repetitive pulsed-power technology (for MIF, IFE approaches)
 - Specific challenges presented by use of advanced fuels
 - Compatibility with advanced power cycles
- ▶ Reduced emphasis on
 - Developing 150-dpa solid materials
 - Solid-material divertors



U.S. DEPARTMENT OF
ENERGY

<https://arpa-e.energy.gov>