

The State of Technology

Evaluation of P5 Report Execution Status *Instrumentation and Computing*

Marcel Demarteau (ORNL)
demarteau@ornl.gov

HEPAP Meeting
Bethesda, MD
November 21— 22, 2019



P5 Recommendations

- The recommendations in the P5 report pertaining to instrumentation and computing are recommendations 27, 28 and 29:
 - **Recommendation 27:** Focus resources toward directed instrumentation R&D in the near-term for high-priority projects. As the technical challenges of current high-priority projects are met, restore to the extent possible a balanced mix of short-term and long-term R&D.
 - **Recommendation 28:** Strengthen university-national laboratory partnerships in instrumentation R&D through investment in instrumentation at universities. Encourage graduate programs with a focus on instrumentation education at HEP supported universities and laboratories, and fully exploit the unique capabilities and facilities offered at each.
 - **Recommendation 29:** Strengthen the global cooperation among laboratories and universities to address computing and scientific software needs, and provide efficient training in next-generation hardware and data-science software relevant to particle physics. Investigate models for the development and maintenance of major software within and across research areas, including long-term data and software preservation.
 - **Note:** the boundaries between budget and reporting categories for detector R&D and computational HEP and project support is blurry. In many cases, support was leveraged with project, institutional or international support

P5 Recommendations

- The recommendations in the P5 report pertaining to instrumentation and computing are recommendations 27, 28 and 29:
 - **Recommendation 27: Focus resources toward directed instrumentation R&D in the near-term for high-priority projects.** As the technical challenges of current high-priority projects are met, restore to the extent possible a balanced mix of short-term and long-term R&D.
 - **Recommendation 28:** Strengthen university-national laboratory partnerships in instrumentation R&D through investment in instrumentation at universities. Encourage graduate programs with a focus on instrumentation education at HEP supported universities and laboratories, and fully exploit the unique capabilities and facilities offered at each.
 - **Recommendation 29:** Strengthen the global cooperation among laboratories and universities to address computing and scientific software needs, and provide efficient training in next-generation hardware and data-science software relevant to particle physics. Investigate models for the development and maintenance of major software within and across research areas, including long-term data and software preservation.
 - Note: the boundaries between budget and reporting categories for detector R&D and computational HEP and project support is blurry. In many cases, support was leveraged with project, institutional or international support

High-Priority Projects



- At the time of the P5 report, Mu2e and the LHC Phase-I Upgrades were near or past CD-3.
- Directed R&D targeted the successful completion of the R&D for
 - The Phase-II upgrades of the LHC,
 - DUNE,
 - G2 dark matter experiments,
 - ILC,
 - Initiate R&D for CMB-S4
- Little development for LSST and DESI was supported on the generic R&D budget

Phase-II Upgrades for the LHC

New Tracker

- Radiation tolerant - high granularity - less material
- Tracks in hardware trigger (L1)
- Coverage up to $\eta \sim 2.7$

End Cap Calorimetry

- Timing Layer

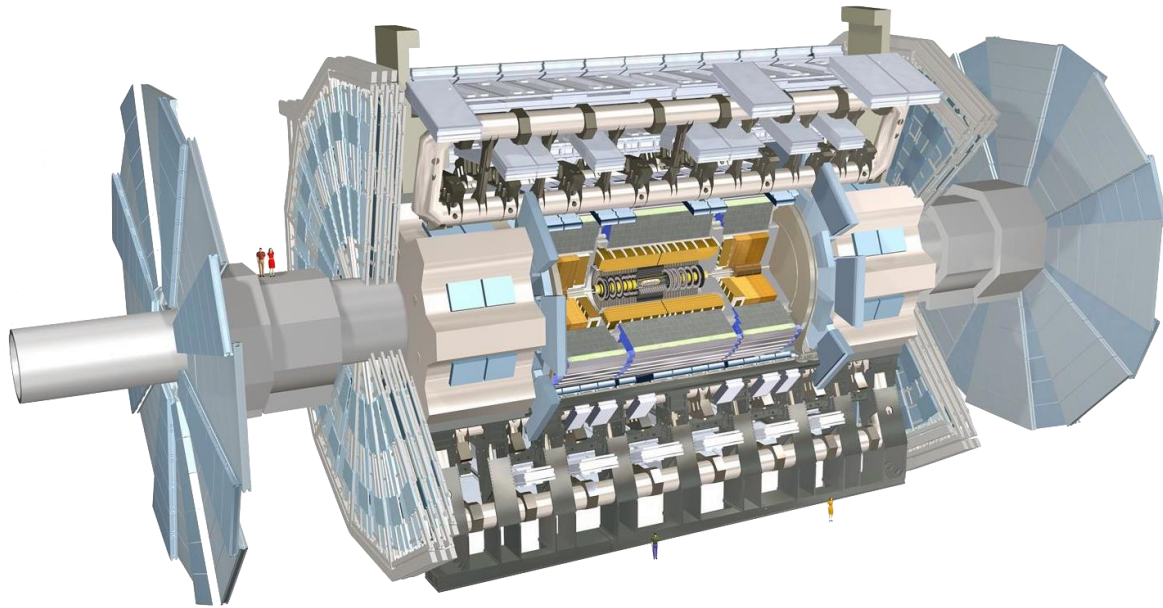

Trigger/DAQ

- L0/L1 split with readout at 40 MHz
- L1 Track trigger
- L1 Output ~ 500 kHz, Latency $\geq 20\mu\text{s}$
- HLT output up to 10 kHz

Electronics

- Calorimeter FE and BE
- Muon readout

Phase-II Upgrades for the LHC

New Tracker

- Radiation tolerant - high granularity - less material
- Tracks in hardware trigger (L1)
- Coverage up to $\eta \sim 2.7$

End Cap Calorimetry

- Timing Layer

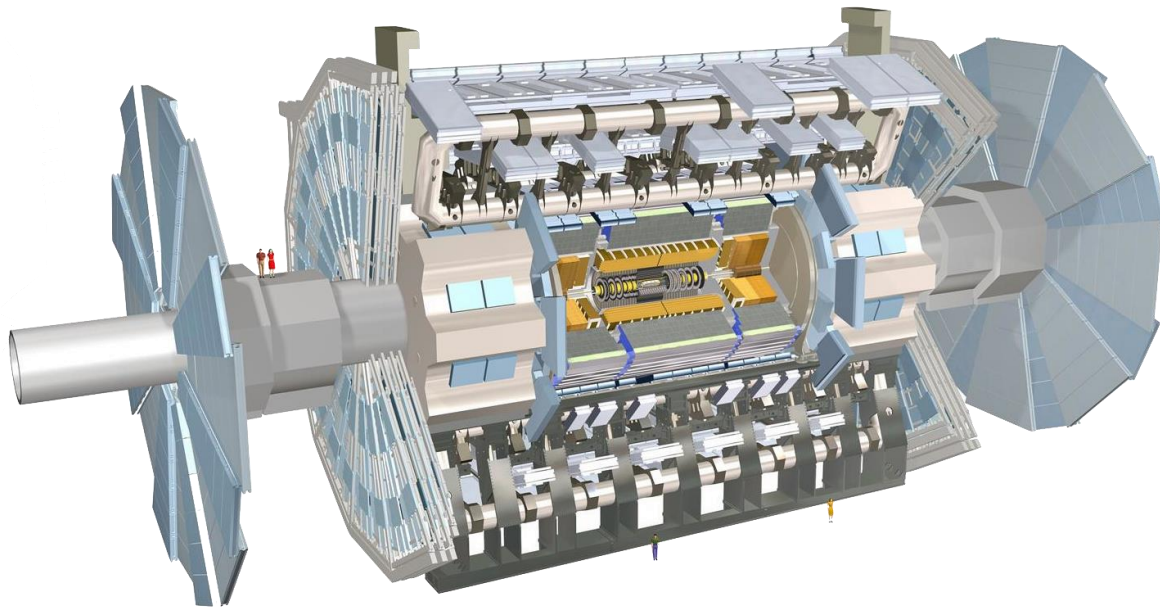

New Tracker

- Radiation tolerant - high granularity
- less material
- Tracks in hardware trigger (L1)
- Coverage up to $\eta \sim 4$

Muons

- Replace DT FE electronics
- Complete RPC coverage in forward region (new GEM/RPC technology)
- Investigate Muon-tagging up to $\eta \sim 4$

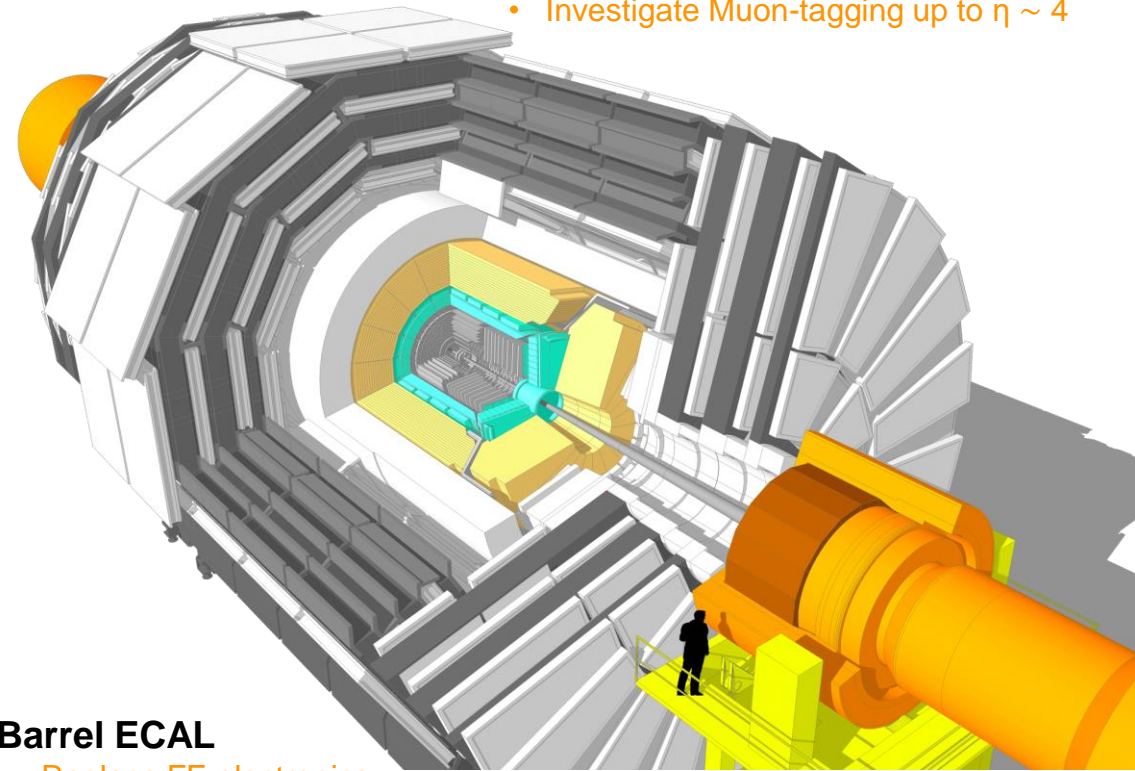

Barrel ECAL

- Replace FE electronics

New EC Calorimeters

- Radiation tolerant - high granularity
- Investigate coverage up to $\eta \sim 4$

Trigger/DAQ

- L1 (hardware) with tracks and rate up ~ 500 kHz to 1 MHz
- Latency $\sim 12.5\mu\text{s}$
- HLT output up to 10 kHz

Trigger/DAQ

- L0/L1 split with readout at 40 MHz
- L1 Track trigger
- L1 Output ~ 500 kHz, Latency $\geq 20\mu\text{s}$
- HLT output up to 10 kHz

Electronics

- Calorimeter FE and BE
- Muon readout

Phase-II Upgrades for the LHC: Perspective

- The HL-LHC had the highest priority in the P5 report and successful execution is of critical importance
- It is useful to keep in mind that these “upgrade” projects are unprecedented:
 - The scale is arguably the largest ever for an ‘upgrade’.
 - The upgrades are taking place while the Phase-1 upgrade are finishing and the collaboration is running the experiment.
 - Novel technologies are exercised on unprecedented scale
 - First time 8” silicon wafer technology being considered, on a scale of $\sim 600 \text{ m}^2$
 - First time use of novel sensor technologies for fast timing in silicon
 - First time epitaxial Si being deployed on such a scale (ALICE epitaxial: $\sim 10 \text{ m}^2$)
 - System-level timing of $>100\text{k}$ channels at the 30ps level
 - First time calorimeter with $\sim 6.5\text{M}$ channels, to calibrate, monitor, readout ...
 - Extensive use of flex module technologies at the edge of the state-of-the-art
 - ...
- Various paradigm shifts to be executed for the first time on a scale that is also unprecedented:
 - Five-dimensional Particle Flow calorimetry
 - First level track trigger with p_T -modules
 - ...

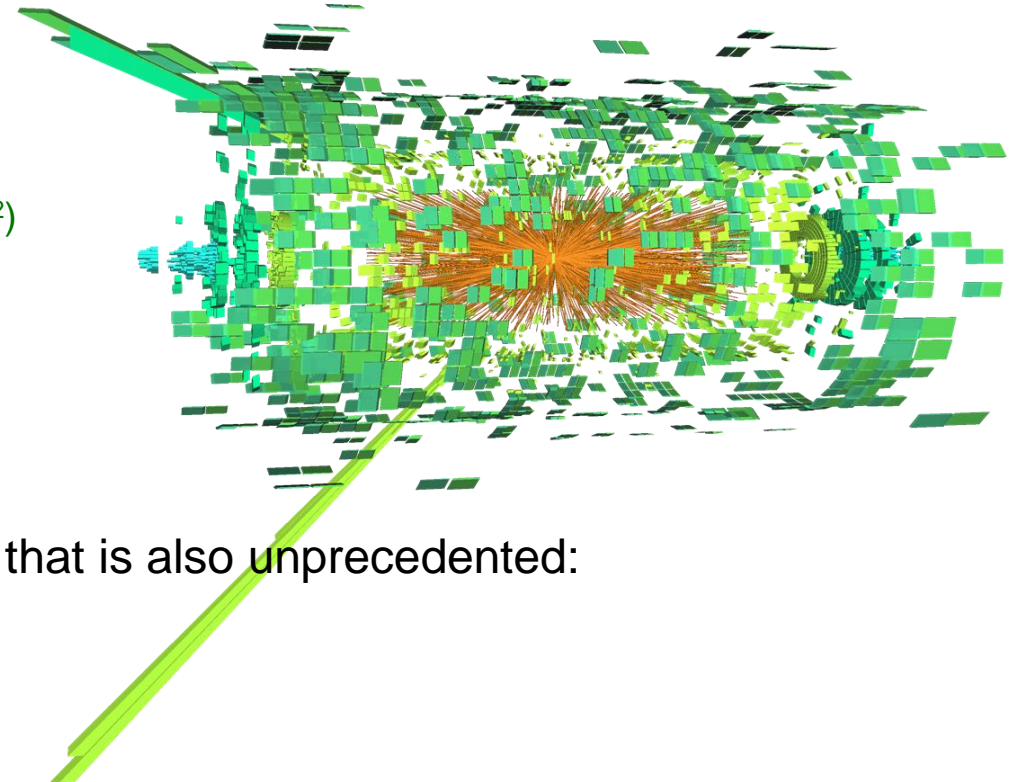

Phase-II Upgrades for the LHC: Perspective

- Both ATLAS and CMS have completed their R&D for the HL-LHC and are well towards CD-2 with significant investment of directed R&D funds.

CMS High-Granularity Calorimeter

- ~640 m² of silicon
- ~370 m² of scintillators
- 6.1M Si channels
- 240k scint-tile channels
- ~31000 Si modules

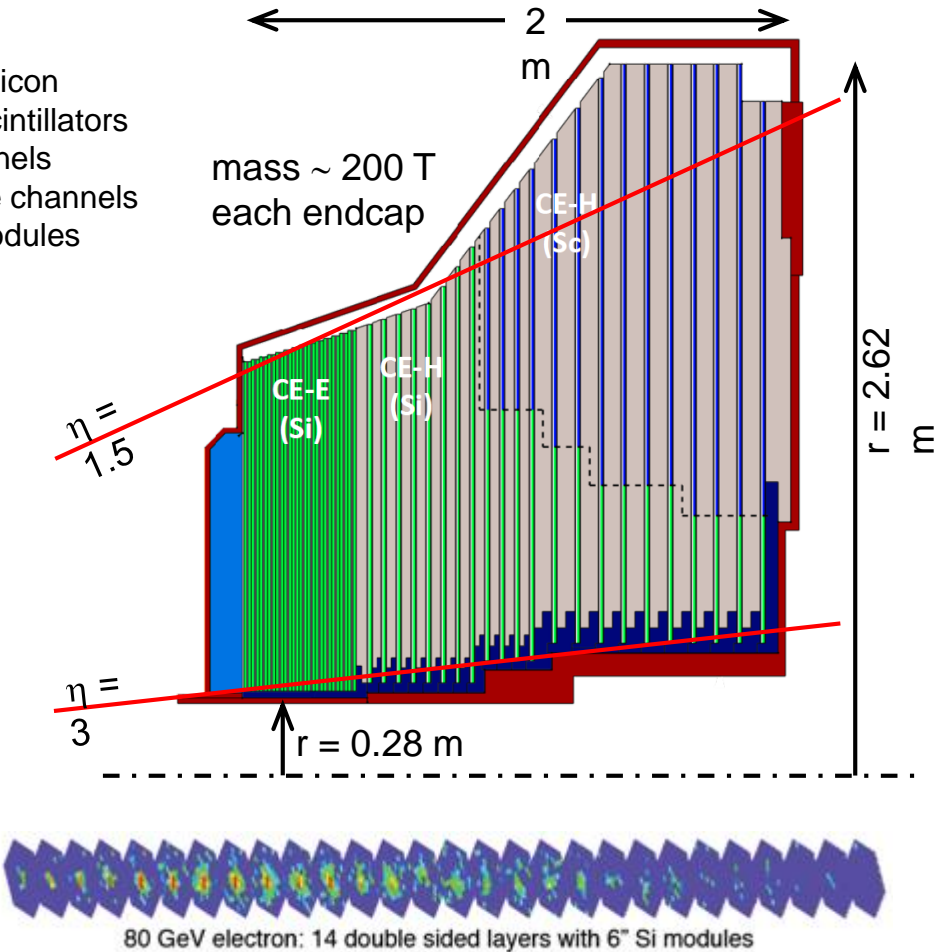

ATLAS High-Granularity Timing Detector

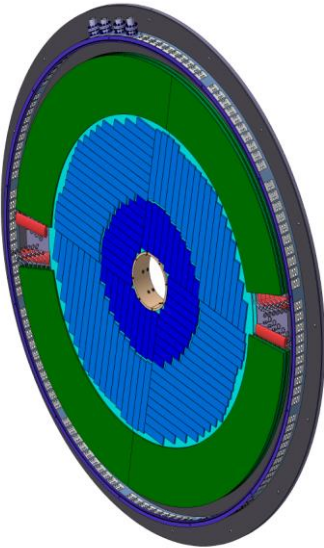

Size: 1.3x1.3 mm²
 3.59M channels
 6.4 m² of silicon (LGAD)
 Timing resolution 50ps

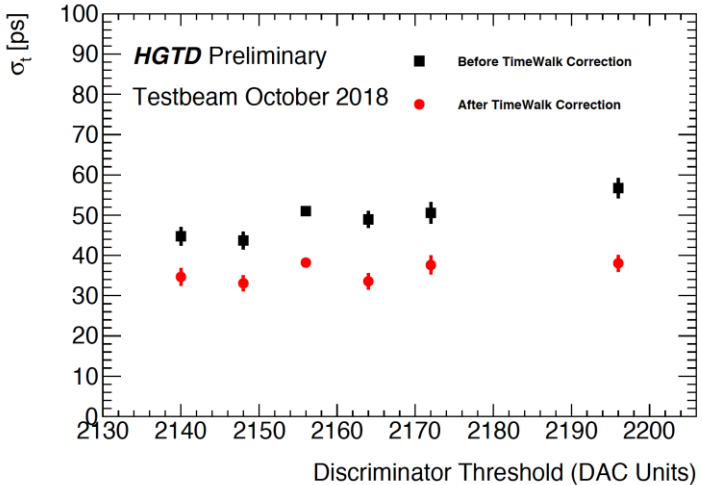
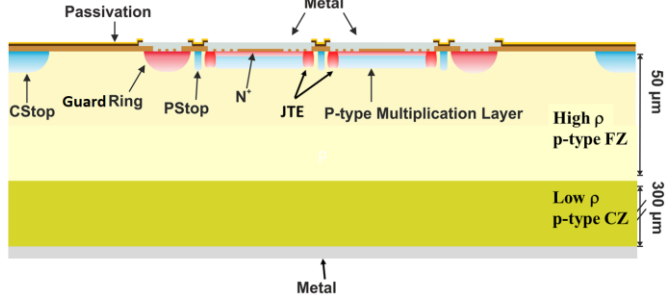

DUNE

- Huge progress in the development of LArTPC R&D through the successful operation of ProtoDUNE at CERN and the prior development of the Liquid Argon Prototype Detectors
 - Very low noise operation of cold electronics, including ADC and digital signal processing in the cold
 - High purity and long drift electron lifetime in large membrane cryostats
 - Full high voltage operation (500 V/cm)
- Builds on development of ICARUS, MicroBooNE and SBND and critical LArTPC R&D

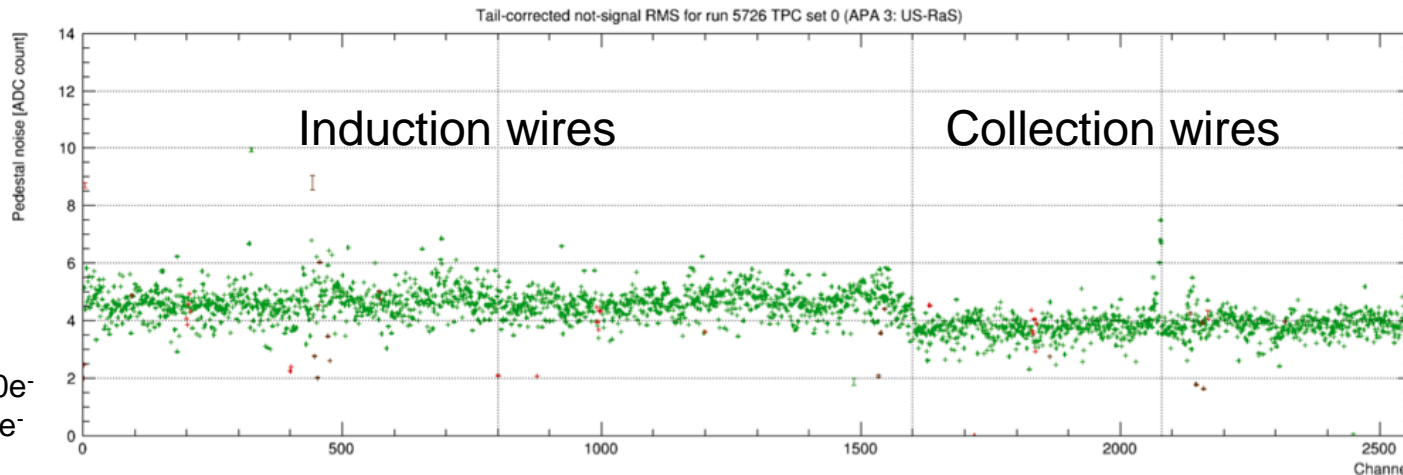
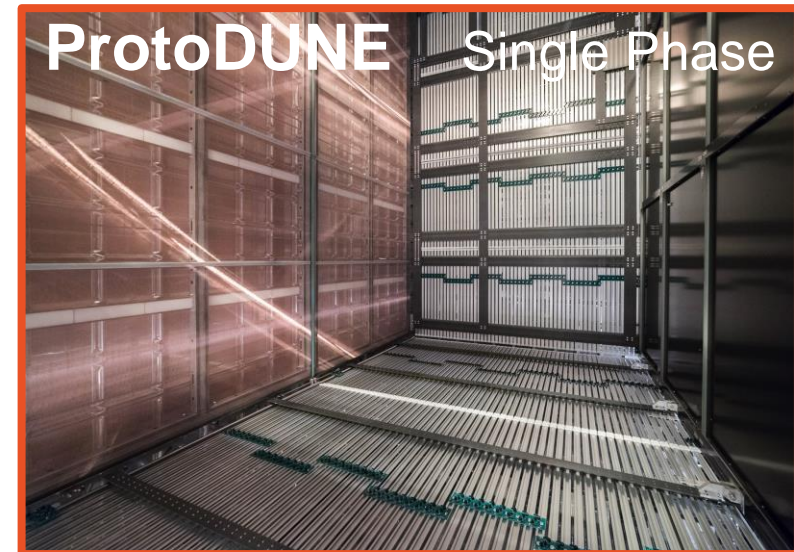
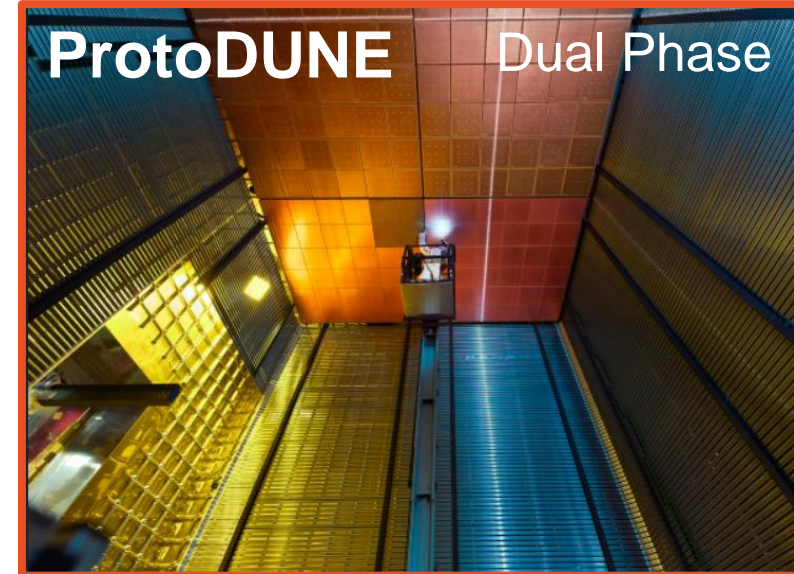

DUNE

- Large area pixel readout (LArPix) for LArTPC (LBNL)
- ASIC development for DUNE and nEXO (SLAC)
- Integrated pixel charge (Qpix) and light readout (ANL)
- Understanding performance of large LAr TPCs through measurement of fundamental LAr properties (BNL)
- All of these include university partnerships and international collaboration
- NSF: significant investment in development of LArTPCs through Argonne, MicroBooNE and SBND and techniques for APAs

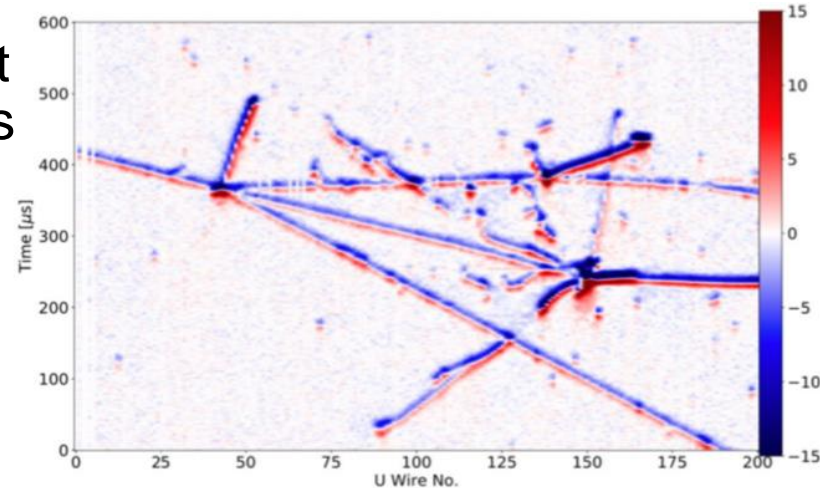

Short Baseline Program

- As part of recommendation 15 (*Select and perform in the short term a set of small-scale short-baseline experiments ... use liquid argon to advance the technology*) also R&D directed towards the short baseline program at Fermilab:
 - Construction of the Anode Plane Arrays and TPC field cage
 - SBND warm readout electronics
 - PMT photon detection system



One of 4 wire planes (APA) in the SBND TPC (Fermilab)

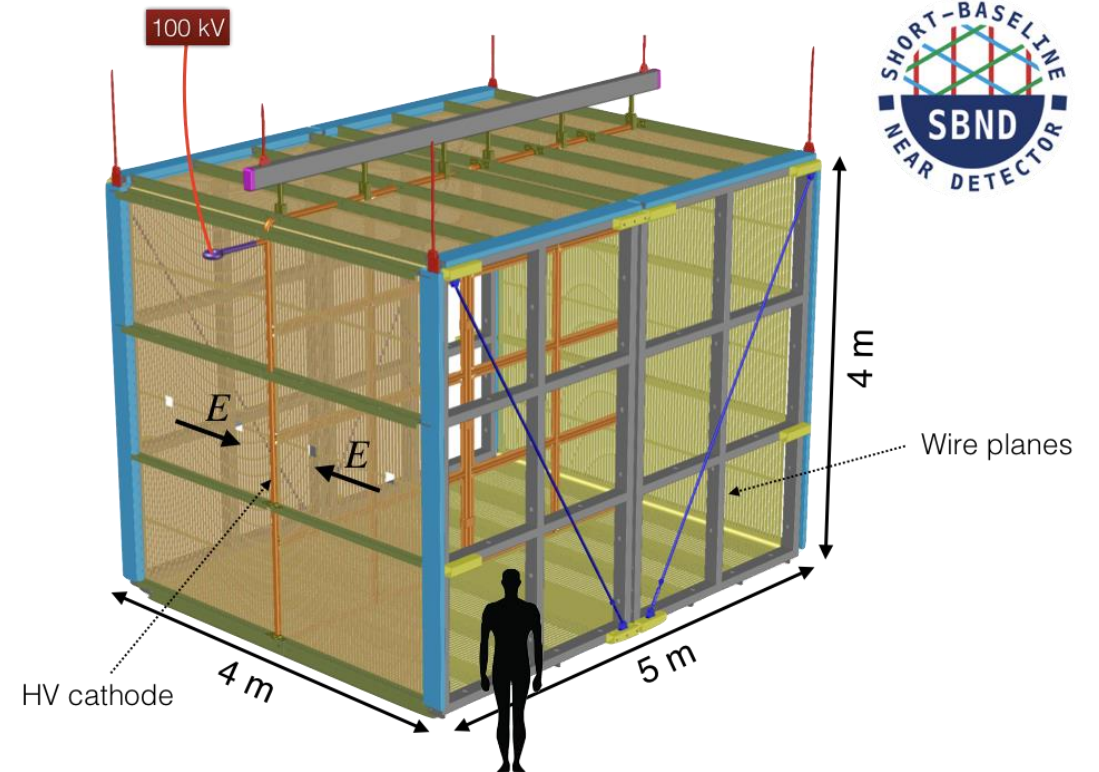

International Linear Collider

- The instrumentation development for the ILC was generic and pursued novel avenues for instrumentation development. That support has been sacrificed for directed R&D for the more immediate high priority projects.
- As an aside, some of the R&D within the framework of the ILC has been adopted by other collider experiments

Micro Pattern Gas Detectors

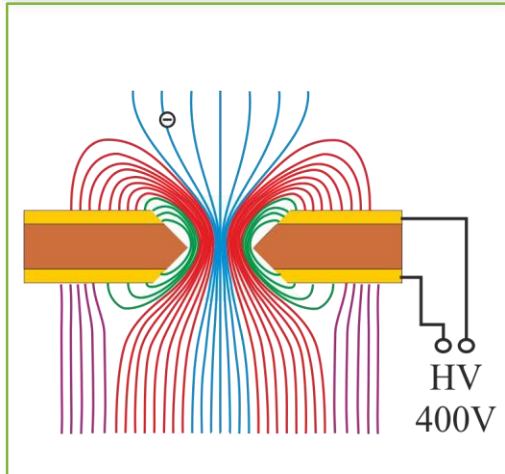

Depleted MAPS

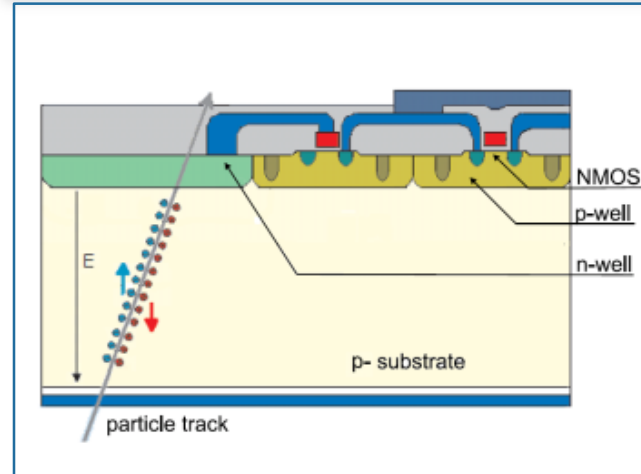

High Grained Calorimetry

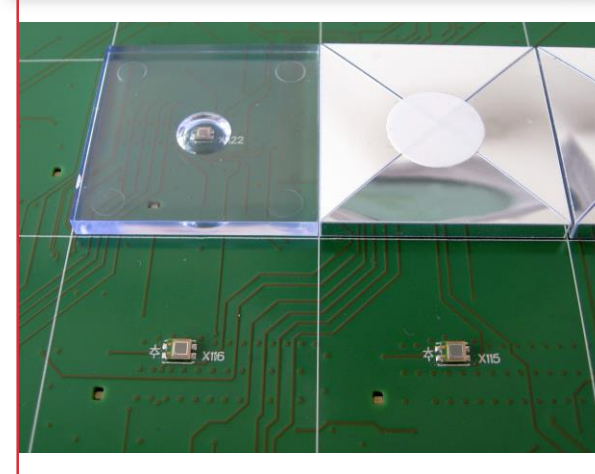

Silicon-W Calorimetry

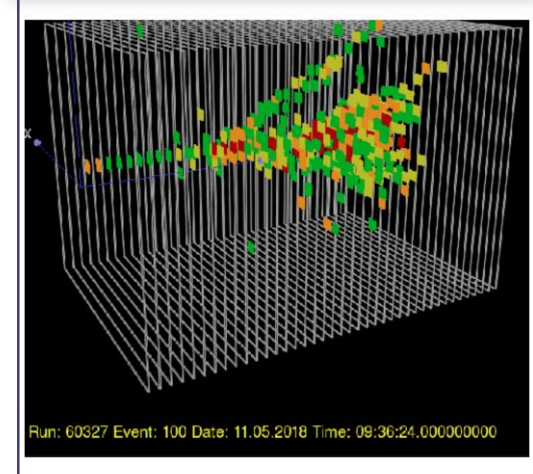

CMB-S4

- CMB-S4 was included as part of the P5 project portfolio and has received CD-0 on July 28, 2019
- Close coordination between NSF and DOE; MSRI design and proposal under review at NSF; requirements for NSF MREFC under review.
- Modest support for detector development to start the project:
 - Readout: TDM, FDM, μ MUX
 - Transition Edge Sensors and fabrication facilities
 - Telescope design, ...

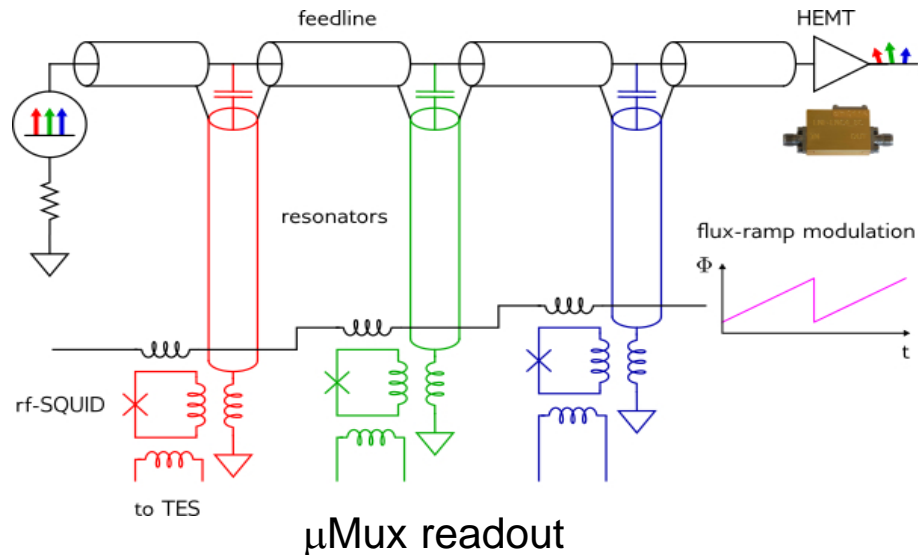

Detector module

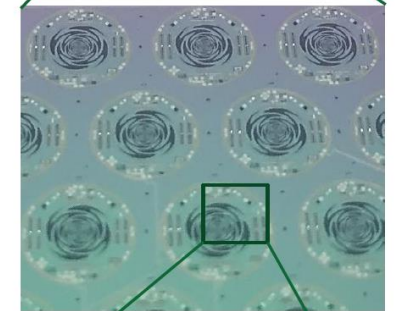
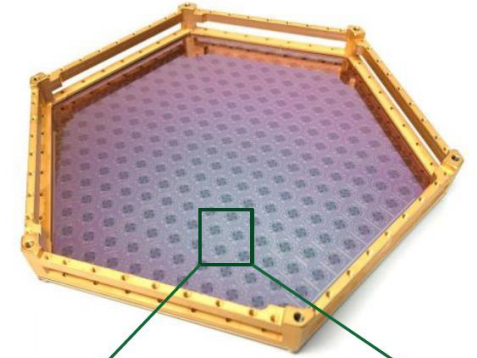

Multi-chroic Transition Edge sensor

Facilities Support

- To deliver on the high-priority projects, a key element has been the availability of test facilities to support instrumentation development

Low Background Facility

Provides support for low-background experiments in the areas of materials and assay

Critical need for low-background experiments

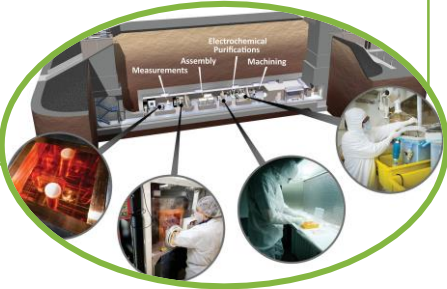

Test Beams

Provides high-quality beams and data taking infrastructure to develop and characterize new detector technologies

Critical need to explore new technologies

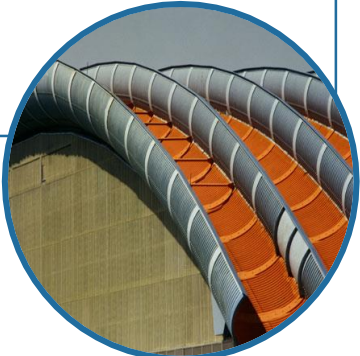

Irradiation Facilities

Provides facilities to validate radiation resistance to extremely high fluences

Essential for Energy and Intensity Frontier experiments

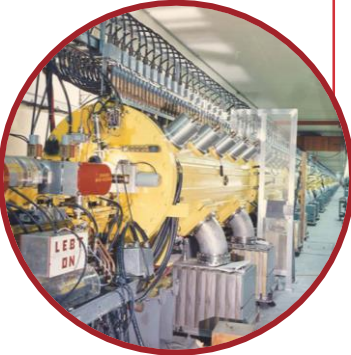

Characterization Platforms

Provides platforms for determining fundamental physics of materials

Vital for determining proof of principle and long-term viability of proposed materials and environments



Facilities Support: Low Background Facility

- PNNL's Shallow Underground Laboratory provides support sought by dark matter experimental collaborations for experience and expertise depth in:
 - Materials and assay
 - Low background design and construction
 - Novel radiation detector developments to reduce backgrounds
 - Unique facilities and resources for low background development

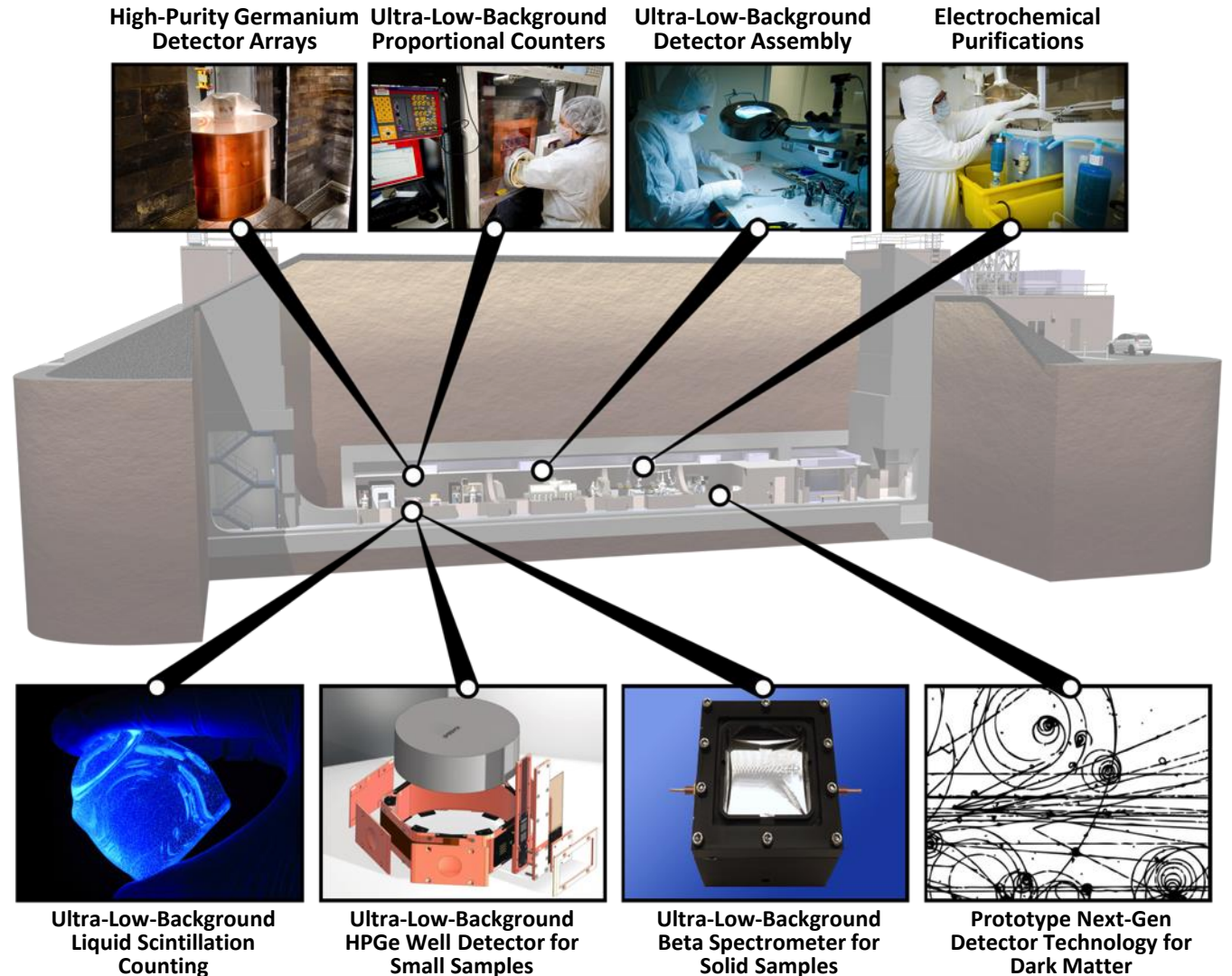

Facilities Support: Low Background Facility

- PNNL's Shallow Underground Laboratory provides support sought by dark matter experimental collaborations for experience and expertise depth in:
 - Materials and assay
 - Low background design and construction
 - Novel radiation detector developments to reduce backgrounds
 - Unique facilities and resources for low background development

Experiments Supported

Material	Supported Experiments
(Electroformed) Copper	Majorana, SuperCDMS, DarkSide
Lead	Majorana, SuperCDMS
Titanium	LZ
Stainless Steel	PICO (COUPP), DarkSide
Polymers	Majorana, SuperCDMS, DarkSide, LZ
Linear Alkyl Benzene (LAB)	SuperCDMS, LZ
Quartz	PICO, DarkSide
Fused Silica	PICO, DarkSide
Electronic Components	SuperCDMS
Connectors	Majorana, SuperCDMS
Solutions	Majorana, SuperCDMS, PICO
Filter Particulates	PICO (COUPP), SuperCDMS, LZ
NaI scintillator crystals	SABRE

- Supported also some targeted emergency responses and longer term concerns (e.g. tritium and ^{32}Si backgrounds for next-generation experiments)

Facilities Support: Test Beams

- Fermilab Test Beam has serviced large user community with critical support for high-priority projects
 - R&D directed toward the HL-LHC upgrade of CMS
 - High-grained calorimeter; Low Gain Avalanche Diode (LGAD) sensors; rad-hard ASIC tests; tile scintillator R&D, ...

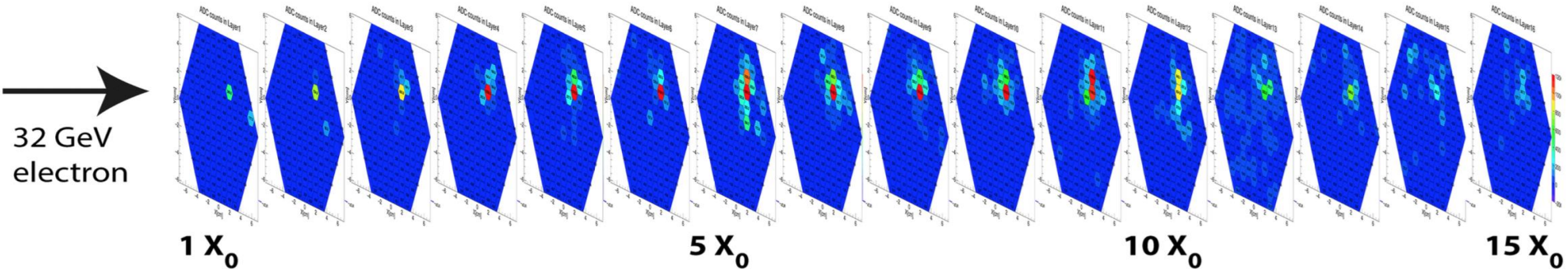

Experiment Beam	weeks
Collider (LHC)	35
Collider (Non-LHC)	11
General R&D	2
Muon	2
Outreach/Facility	1
Neutrino	4
Total	55

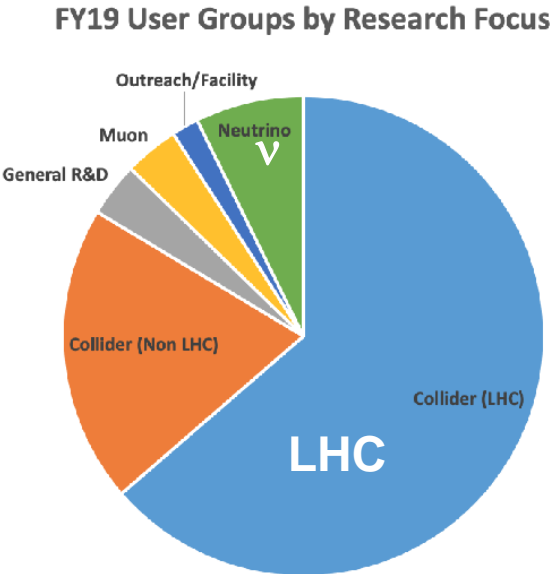

Facilities Support: Irradiation Facilities

- Brookhaven Linear Isotope Producer
 - Material irradiation by 181 MeV p ($\sim 130 \mu\text{A}$) at BNL BLIP facility for targetry
 - In-beam thermal shock test at CERN HiRadMat facility, Tensile tests at PNNL
- Los Alamos Neutron Science Center
 - Proton beams of 800 MeV with $\sim 10^{11}$ p/cm²/s
- Neutron irradiation at the Rhode Island Nuclear Science Center
 - Maximum neutron flux of 3×10^{12} n/cm²/s at core end; 6" and 8" ports available
- NASA Space Radiation Laboratory (BNL)
 - ~ 1000 beam hours/year of protons to Au (up to 2.5 GeV/n)
 - 2.5 GeV protons at $\sim 2.2 \times 10^{11}$ cm⁻²
- Fermilab Irradiation Test Area only now being constructed

Tensile testing of Ti alloys at PNNL for targetry



Facilities Support: Characterization Platforms

Noble Liquid Platform

System test of components of noble liquid detectors under operating conditions



Calibration Platform

Calibration platform for various systems, such as liquid Argon field cage system to measure TPC field response



Irradiation Evaluation Platform

Evaluate radiation resistance of materials exposed to extremely high fluences for targetry



Fundamental Properties Platform

Platform for measurement of fundamental physics properties

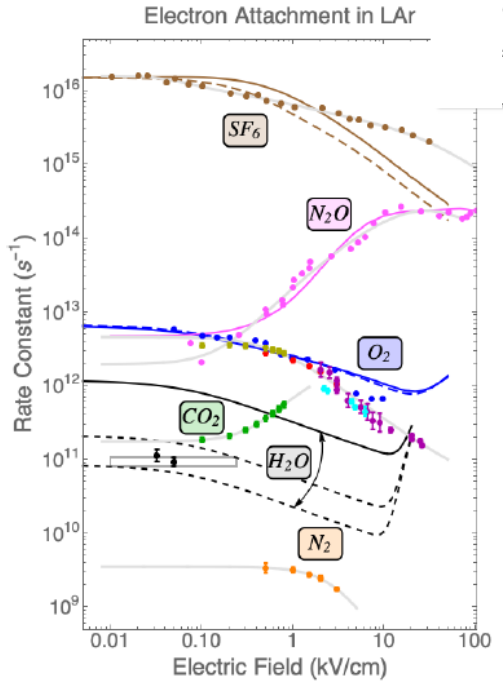

P5 Recommendations

- The recommendations in the P5 report pertaining to instrumentation and computing are recommendations 27, 28 and 29:
 - **Recommendation 27: Focus resources toward directed instrumentation R&D in the near-term for high-priority projects.**
- **The program has closely followed the P5 recommendation to enable the high-priority projects building on current technologies with limited support for generic R&D more later**
- **Programs also benefited strongly from indirect support, such as ECA, LDRD funding, private funding**

P5 Recommendations

- The recommendations in the P5 report pertaining to instrumentation and computing are recommendations 27, 28 and 29:
 - **Recommendation 27:** Focus resources toward directed instrumentation R&D in the near-term for high-priority projects. As the technical challenges of current high-priority projects are met, restore to the extent possible a balanced mix of short-term and long-term R&D.
 - **Recommendation 28: Strengthen university-national laboratory partnerships in instrumentation R&D through investment in instrumentation at universities.** Encourage graduate programs with a focus on instrumentation education at HEP supported universities and laboratories, and fully exploit the unique capabilities and facilities offered at each.
 - **Recommendation 29:** Strengthen the global cooperation among laboratories and universities to address computing and scientific software needs, and provide efficient training in next-generation hardware and data-science software relevant to particle physics. Investigate models for the development and maintenance of major software within and across research areas, including long-term data and software preservation.
 - Note: the boundaries between budget and reporting categories for detector R&D and computational HEP and project support is blurry. In many cases, support was leveraged with project, institutional or international support

University-national laboratory partnerships

- Good progress has been made in strengthening the partnerships
- A great impulse in strengthening the university instrumentation program is the NSF contribution to the HL-LHC projects; there are numerous universities involved in the construction projects for both ATLAS and CMS
- Other examples are:
 - Upstream Tracker construction at Syracuse for LHCb
 - Consortium of Yale, Chicago and Syracuse for the construction the SBND TPC
 - Columbia University to build the SBND warm readout electronics
 - Yale university building detector assemblies for PROSPECT
 - Photodetector characterization at Brown University for LZ
 - University of Michigan for fiber positioners for DESI
 - Instrument control system for DESI at Ohio State
 - Petal reference bodies machined at Boston University for DESI
 - ...

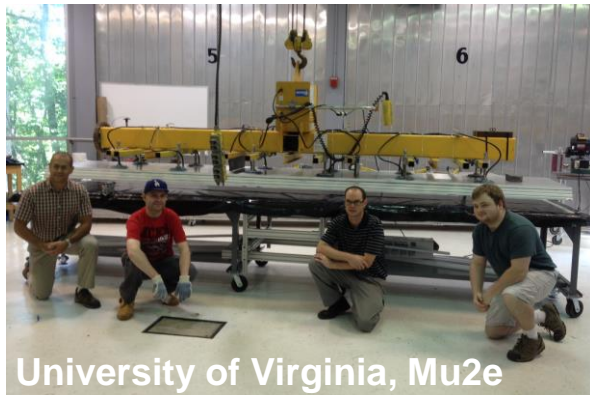

P5 Recommendations

- The recommendations in the P5 report pertaining to instrumentation and computing are recommendations 27, 28 and 29:
 - **Recommendation 28: Strengthen university-national laboratory partnerships in instrumentation R&D through investment in instrumentation at universities.**
- **The program has been successful in strengthening the university-national lab partnership in instrumentation by enabling universities to build major components of new projects.**

P5 Recommendations

- The recommendations in the P5 report pertaining to instrumentation and computing are recommendations 27, 28 and 29:
 - **Recommendation 27:** Focus resources toward directed instrumentation R&D in the near-term for high-priority projects. As the technical challenges of current high-priority projects are met, restore to the extent possible a balanced mix of short-term and long-term R&D.
 - **Recommendation 28:** Strengthen university-national laboratory partnerships in instrumentation R&D through investment in instrumentation at universities. **Encourage graduate programs with a focus on instrumentation education at HEP supported universities and laboratories, and fully exploit the unique capabilities and facilities offered at each.**
 - **Recommendation 29:** Strengthen the global cooperation among laboratories and universities to address computing and scientific software needs, and provide efficient training in next-generation hardware and data-science software relevant to particle physics. Investigate models for the development and maintenance of major software within and across research areas, including long-term data and software preservation.
 - Note: the boundaries between budget and reporting categories for detector R&D and computational HEP and project support is blurry. In many cases, support was leveraged with project, institutional or international support

Graduate Programs

- The Coordinating Panel for Advanced Detectors (CPAD) has, with the support of OHEP, established a Graduate Instrumentation Research Award (GIRA)
 - Program now in its third year

Graduate Instrumentation Research Award (GIRA)

<https://detectors.fnal.gov/gira/>



Vetri Velan (UC Berkeley)
“Measurement of Light and Heat Signal Yields in Superfluid ^4He With Calorimetric Readout”

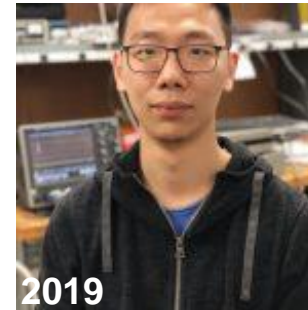

Xinran Li (Princeton)
“High resolution selenium imaging detector for neutrinoless $\beta\beta$ decay”



Yiou Zhang (Brown)
“Development of magnetic tunnel junction sensor array for detection of axion condensate – novel physics of dark matter”

Graduate Programs

- The Coordinating Panel for Advanced Detectors (CPAD) has, with the support of OHEP, established a Graduate Instrumentation Research Award (GIRA)
 - Program now in its third year
- Created in collaboration with Japan the Ozaki Exchange Program for the exchange of graduate students between Japan and the US in accelerator and particle physics.

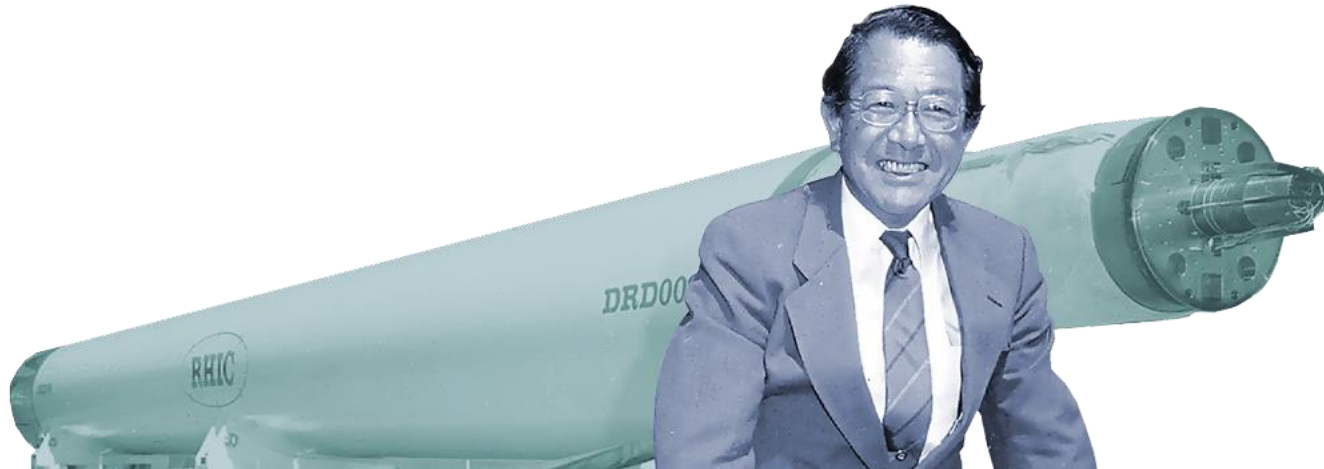

<https://www.bnl.gov/ozaki/>

Graduate Instrumentation Research Award (GIRA)

<https://detectors.fnal.gov/gira/>



Vetri Velan (UC Berkeley)
“Measurement of Light and Heat Signal Yields in Superfluid ^4He With Calorimetric Readout”



Xinran Li (Princeton)
“High resolution selenium imaging detector for neutrinoless $\beta\beta$ decay”



Yiou Zhang (Brown)
“Development of magnetic tunnel junction sensor array for detection of axion condensate – novel physics of dark matter”

P5 Recommendations

- The recommendations in the P5 report pertaining to instrumentation and computing are recommendations 27, 28 and 29:
 - **Recommendation 28:** Strengthen university-national laboratory partnerships in instrumentation R&D through investment in instrumentation at universities. **Encourage graduate programs with a focus on instrumentation education at HEP supported universities and laboratories, and fully exploit the unique capabilities and facilities offered at each.**
- **Two new graduate program have been created with a focus on instrumentation and accelerator physics; a good start.**

P5 Recommendations

- The recommendations in the P5 report pertaining to instrumentation and computing are recommendations 27, 28 and 29:
 - **Recommendation 29: Strengthen the global cooperation among laboratories and universities to address computing and scientific software needs, and provide efficient training in next-generation hardware and data-science software relevant to particle physics. Investigate models for the development and maintenance of major software within and across research areas, including long-term data and software preservation.**

P5 Recommendations

- The recommendations in the P5 report pertaining to instrumentation and computing are recommendations 27, 28 and 29:
 - **Recommendation 29: Strengthen the global cooperation among laboratories and universities to address computing and scientific software needs**, and provide efficient training in next-generation hardware and data-science software relevant to particle physics. Investigate models for the development and maintenance of major software within and across research areas, including long-term data and software preservation.
 - Note: the boundaries between budget and reporting categories for detector R&D and computational HEP and project support is blurry. In many cases, support was leveraged with project, institutional or international support

Computing and Scientific Software

- P5 and the preceding Snowmass has brought software and computing for HEP in much sharper focus.
- The HEP Software Foundation (HSF) was created in 2014 with large US participation.
 - To facilitate coordination and common efforts in software and computing across HEP in general
 - No “formal” organization
- The HSF was asked by the NSF to write a “roadmap” document, which was extended to encompass the whole HEP community
 - “A Roadmap for HEP Software and Computing R&D for the 2020s” <https://arxiv.org/abs/1712.06982>
 - Established the challenges the community faces, but did not propose a process to tackle the challenges
- This has led to the creation of the “Institute for Research and Innovation in Software for High Energy Physics (IRIS-HEP)”

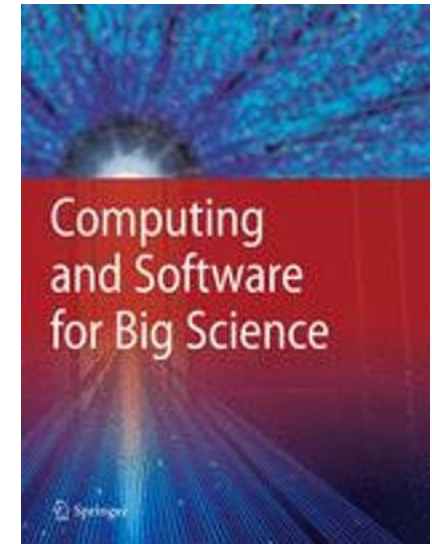

Computing and Scientific Software

- Charge of IRES-HEP
 - Development of innovative algorithms for data reconstruction and triggering;
 - Reduce `time-to-insight` and maximize the HL-LHC physics potential;
 - Development of data organization, management and access
- Around 2014 the HEP Center for Computational Excellence (HEP-CCE) was created as a bridge between the HEP community, HPC-oriented HEP research teams, and ASCR expertise to develop and make available selected HPC tools/capabilities to aid HEP science
- HEP-CCE organized ASCR/HEP requirements review (2017)
- “Projectized” approach to study use of ASCR HPC systems for all HEP frontiers, particularly experiments taking data starting from 2020 onwards
 - Portable Parallelization Strategies
 - Fine-Grained I/O and Storage
 - Event Generators
 - Complex Workflows: Dynamic workflows with GPU exploits

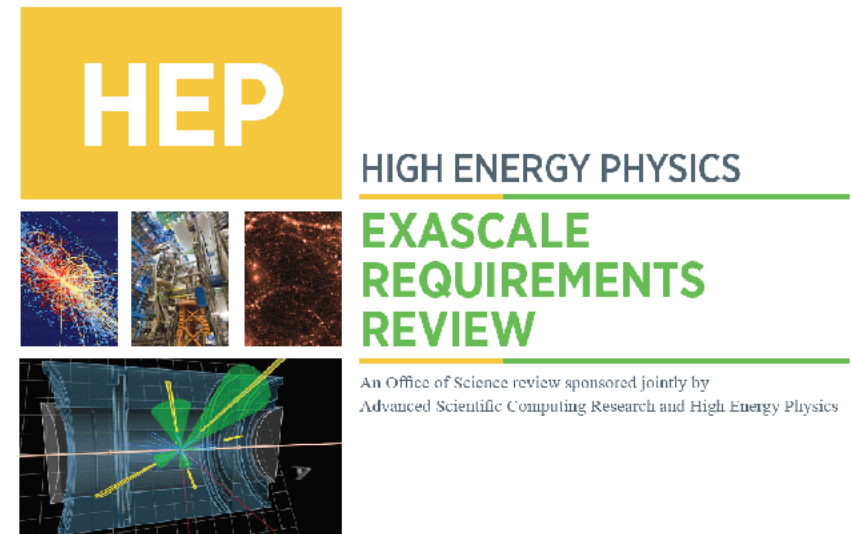

P5 Recommendations

- The recommendations in the P5 report pertaining to instrumentation and computing are recommendations 27, 28 and 29:
 - **Recommendation 29:** Strengthen the global cooperation among laboratories and universities to address computing and scientific software needs, and **provide efficient training in next-generation hardware and data-science software relevant to particle physics**. Investigate models for the development and maintenance of major software within and across research areas, including long-term data and software preservation.

Training

- Every lab is very active in providing training in new computing technologies; internship programs aimed at undergraduate, graduate as well as post-bac and postdoc fellowships offered.
- Large HEP collaborations, IRIS-HEP, provide HEP-specific training programs and fellowships.
- HEP-CCE regularly organizes hackathons
- ATLAS has a program to fund internship and training/hands-on focused workshops in computational physics They also have a new, well received HL-LHC postdoc fellowship program (the 50/50 program) for physicists interested in contributing 50% of their effort to HL-LHC computing and software
- And many more ...
- Is it enough? Career path for HEP software experts is an area of great concern



P5 Recommendations

- The recommendations in the P5 report pertaining to instrumentation and computing are recommendations 27, 28 and 29:
 - **Recommendation 29:** Strengthen the global cooperation among laboratories and universities to address computing and scientific software needs, and provide efficient training in next-generation hardware and data-science software relevant to particle physics. **Investigate models for the development and maintenance of major software within and across research areas, including long-term data and software preservation.**

Data Preservation

- Great strides are being made to have open access to the data



planck



ICECUBE
SOUTH POLE NEUTRINO OBSERVATORY



<http://opendata.cern.ch/>
<https://openlab.cern/>
<http://legacysurvey.org/>

The Challenges

- Event Generation
- Detector Simulation (GEANT)
- Reconstruction and Trigger algorithms
- Data analysis systems
- Frameworks and Integration
- Data Management and storage
- Data Access and Network
- None have been adequately solved to address the HL-LHC challenge
- Note: different accelerators and other chips coming in the near future, portability, verification and software management are real issues

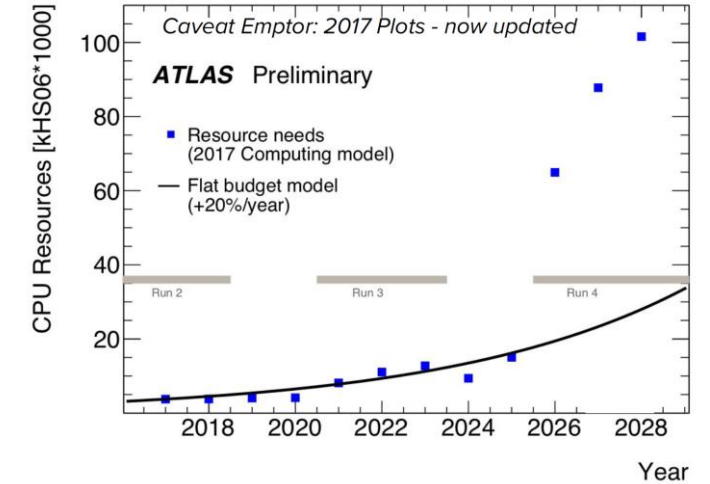
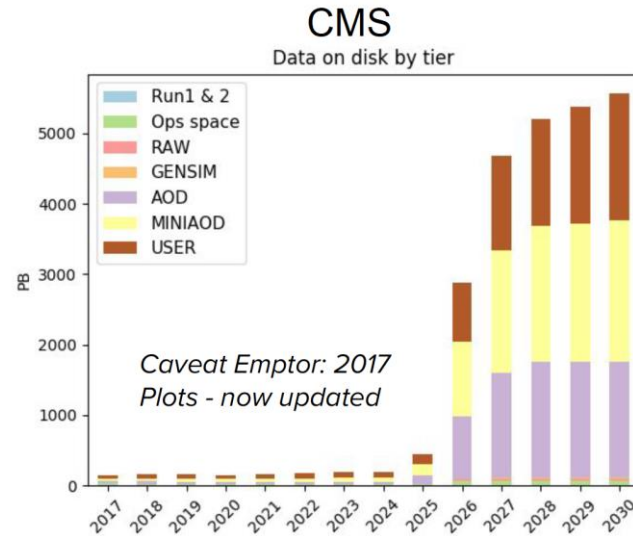

Yearly aggregate traffic in PB carried by ESnet

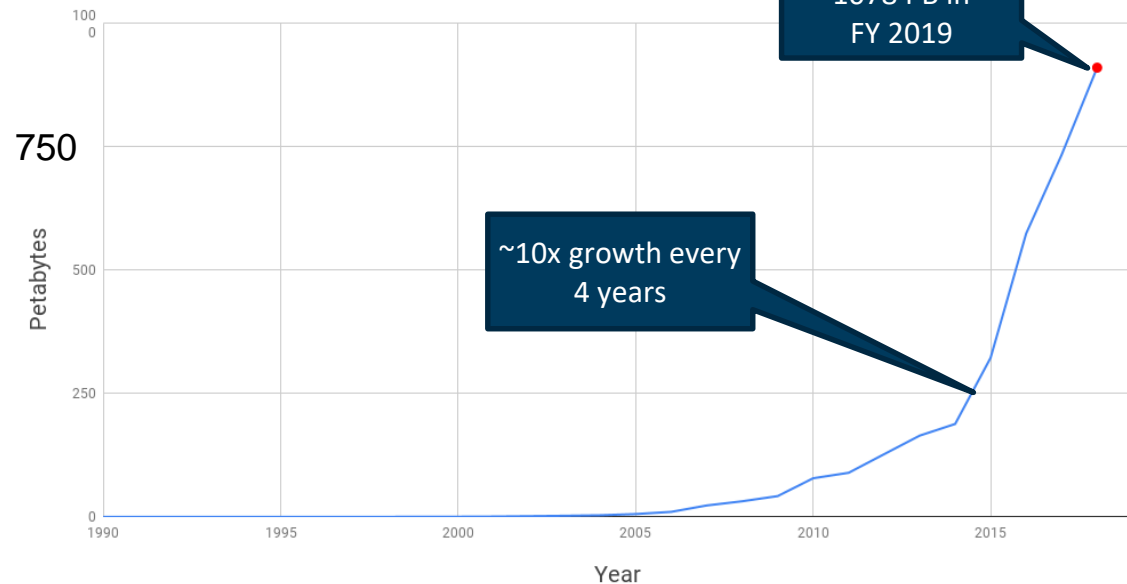

Relevant US DOE Pre-Exascale and Exascale Systems for ECP

Pre-Exascale Systems

First U.S. Exascale Systems*

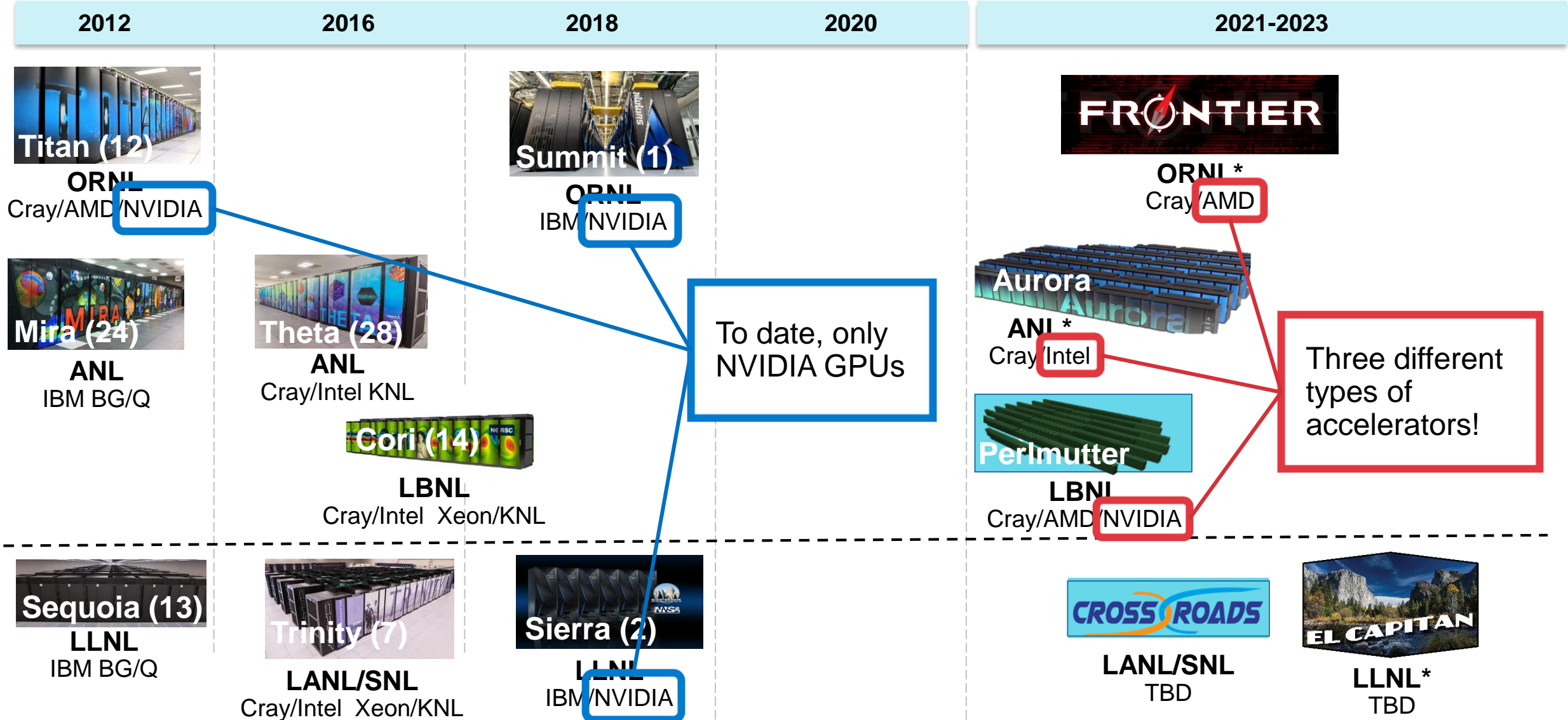

Three different types of accelerators!

To date, only NVIDIA GPUs

Conclusions

- **Recommendation 29: Investigate models for the development and maintenance of major software within and across research areas, including long-term data and software preservation.**
- **The interaction between the various software communities has increased tremendously since the P5 report. Progress has been made in several areas.**
- **The big computing challenges, however, still remain. Not managing the rapid evolution in hardware and software will leave HEP in a vulnerable situation, given the relatively slow evolution of the software. If no action is taken now, the field will not be able to carry out its mission within the next five years. Computing should be treated like a project.**
- **HEP cannot do it alone. Technology overall is progressing very rapidly and the level of sophistication in terms of both technology and architecture requires true expertise that HEP simply does not have.**
- **A new approach to software, computing and the required infrastructure in storage, data management and networking is required.**





Conclusions

- **Recommendation 27:** Focus resources toward directed instrumentation R&D in the near-term for high-priority projects. As the technical challenges of current high-priority projects are met, restore to the extent possible a balanced mix of short-term and long-term R&D.
- The budget for instrumentation development has significantly decreased since P5. Moreover, the program was redirected towards the high-priority experiments.
- **Now that the challenges of the high-priority projects have been met, a sharp pivot is required to aggressively move into generic R&D. Without significant new investment towards generic instrumentation development, the long-term viability of the field will be at risk.**
- Technology development is progressing at lightning speed and the field is not keeping up. Collaboration with other science disciplines should be embraced.





Basic Research Need Workshop

- There will be a DOE OHEP BRN Study on HEP Detector Research and Development on December 11-14, 2019 in the DC area.
- Your input is actively sought.

Physics working groups (based on the five P5 science drivers)

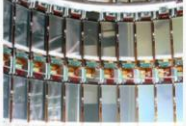
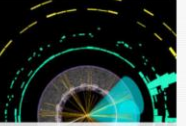
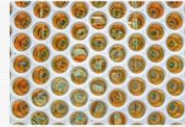
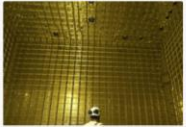
 <p>The Higgs as a tool for discovery</p> <p>Conveners: Jim Hirschauer (FNAL) Gabriella Sciolla (Brandeis)</p>	 <p>The physics of neutrino mass</p> <p>Conveners: Ornella Palamara (FNAL) Kate Scholberg (Duke)</p>	 <p>The new physics of dark matter</p> <p>Conveners: Jodi Cooley (SMU) Dan McKinsey (Berkeley)</p>
 <p>Cosmic acceleration: inflation and dark energy</p> <p>Conveners: Clarence Chang (ANL) Brenna Flaugher (FNAL)</p>	 <p>Exploring the unknown: new particles, new interactions and physical principles</p> <p>Conveners: Sarah Demers (Yale) Monica Pepe-Altarelli (CERN)</p>	

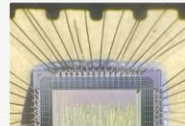
Technology working groups

 <p>Quantum Sensors</p> <p>Conveners: Andy Geraci (Northwestern) Kent Irwin (Stanford)</p>	 <p>Solid State (including vertexing and tracking)</p> <p>Conveners: Marina Artuso (Syracuse) Carl Haber (LBNL)</p>	 <p>Calorimetry</p> <p>Conveners: Francesco Lanni (BNL) Roger Rusack (Minnesota)</p>
 <p>Photodetectors</p> <p>Conveners: Lindley Winslow (MIT) Peter Krizan (Jozef Stefan Institute)</p>	 <p>Noble Liquids</p> <p>Conveners: Roxanne Guenette (Harvard) Jocelyn Monroe (PHIL)</p>	 <p>TDAQ (including Machine Learning)</p> <p>Conveners: Darin Acosta (Florida) Tulika Bose (Wisconsin)</p>
 <p>Redout & ASICs</p> <p>Conveners: Gabriella Carini (BNL) Mitch Newcomer (Penn)</p>	 <p>Cross Cut</p> <p>Conveners: Marcel Demarteau (ORNL) Abe Seiden (UCSC)</p>	

5 physics groups

7 technology groups

1 cross-cut group



With many thanks to: Michael Begel, Ed Blucher, Tom Browder, Paolo Calafiura, Mark Convery, Daniel Eisenstein, Jim Fast, Bonnie Fleming, Doug Glenzinski, Salman Habib, Steve Kettell, Kevin Lesko, Petra Merkel, Jim Miller, Evan Niner, Ornella Palamara, Chris Polly, Mandy Rominsky, Heidi Schellman, Dave Schmitz, Liz Sexton-Kennedy, Eugene Schmidt Jr, Stefan Soldner-Rembold, Torre Wenaus, Sam Zeller, Bob Zwaska, ... and many others