



U.S. DEPARTMENT OF
ENERGY

Office of
Science

Nuclear Physics News

HEPAP Meeting
December 4, 2020

Dr. T. J. Hallman
Associate Director of the Office of Science
for Nuclear Physics

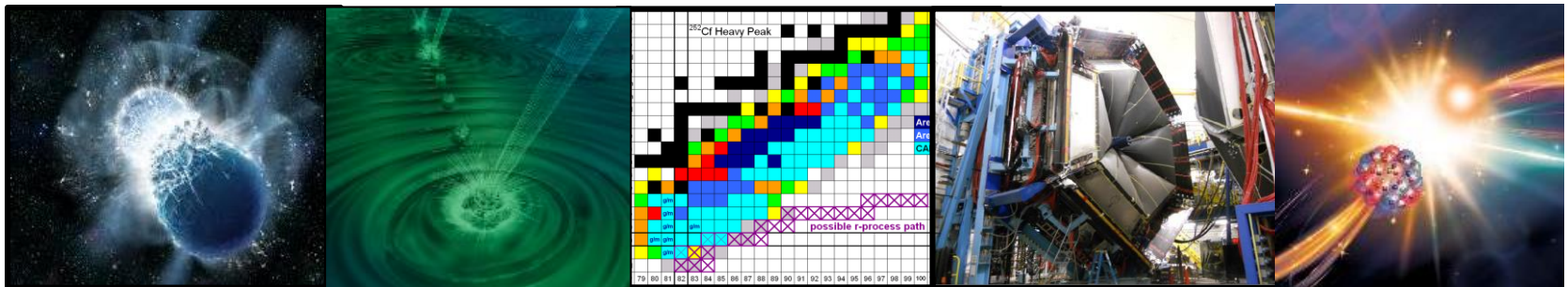

The 2015 Long Range Plan for Nuclear Science

Recommendations:

1. Capitalize on investments made to maintain U.S. leadership in nuclear science. ✓
2. Develop and deploy a U.S.-led ton-scale neutrino-less double beta decay experiment. ✓
3. Construct a high-energy high-luminosity polarized electron-ion collider (EIC) as the highest priority for new construction following the completion of FRIB. ✓
4. Increase investment in small-scale and mid-scale projects and initiatives that enable forefront research at universities and laboratories. ✓

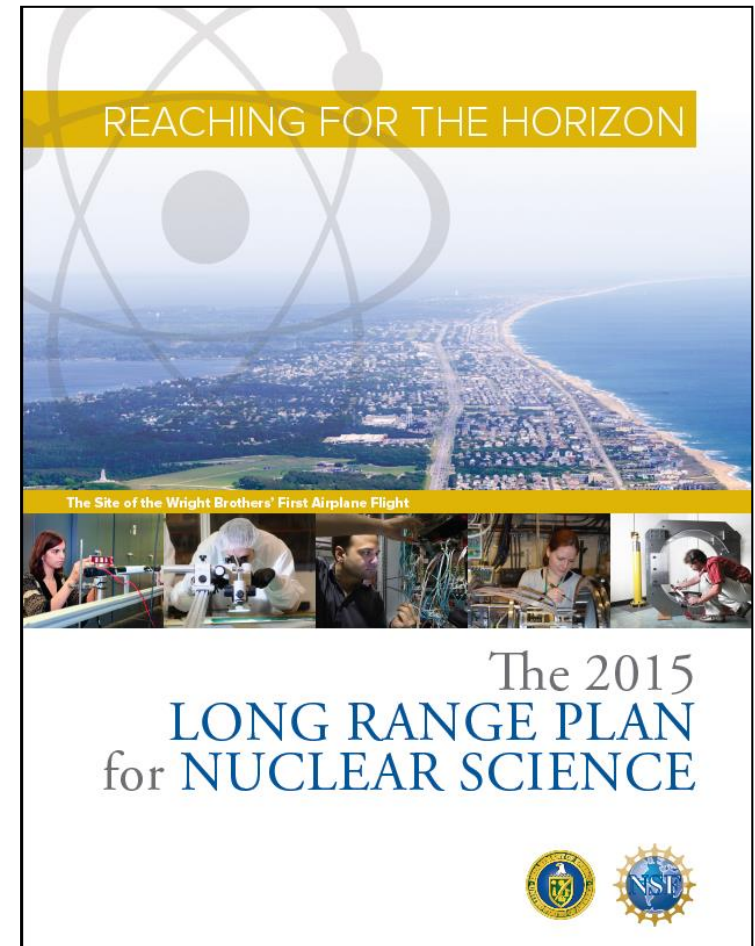

NP continues to execute on the 2015 LRP Vision

Progress in Implementing the Plan Has Been Good



RHIC



JLAB
Hall B



FRIB



ATLAS
At ANL

The vision to maintain U.S. leadership continues to be implemented: EIC construction; FRIB construction

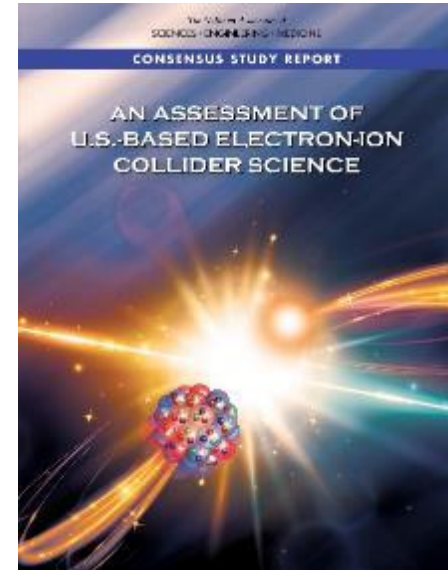

World leading research supported at state-of-the-art NP National User Facilities



Underground
Double Beta Decay
Research

Pioneering experiments and research tools (MIEs) are created

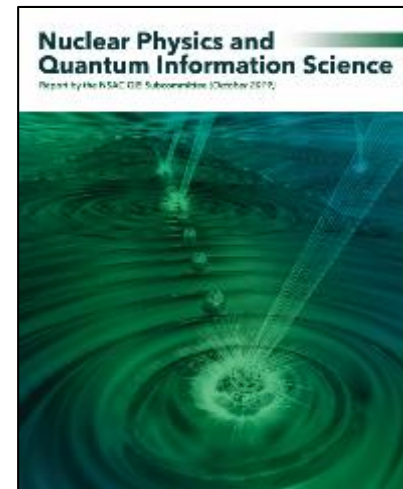

Groundbreaking contributions to national cross-cutting priorities continue

Nuclear Physics

FY 2020 Highlights

It's been a good Year for Facility Operations:

- NP user facilities operated near or at full utilization.
 - RHIC operated for 4000 hours. RHIC continues the Beam Energy Scan II run and, for the first time, utilizes bunched beam electron cooling.
 - CEBAF ran for 2600 hours, with simultaneous 4-hall operation.
 - ATLAS operated for 4500 hours and made significant progress towards a Multi-User Upgrade (MUU) and a new neutron-generator-based source for CARIBU
 - The Facility for Rare Isotope Beams (FRIB) recently accelerated an Argon-36 beam to 204 MeV/nucleon demonstrating the FRIB superconducting linear accelerator operates as intended. Scheduled for on-time, on cost completion in FY 2022, FRIB will enable research opportunities for a worldwide community of over 1,400 scientists.

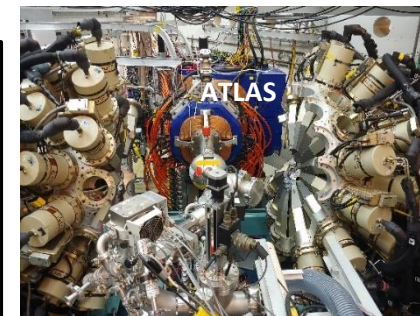
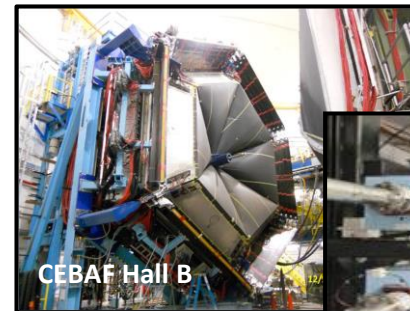
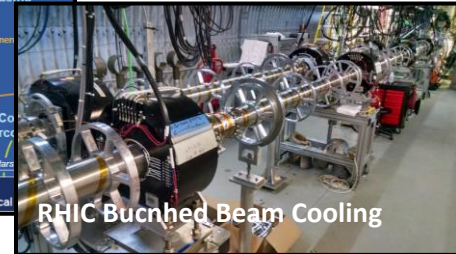
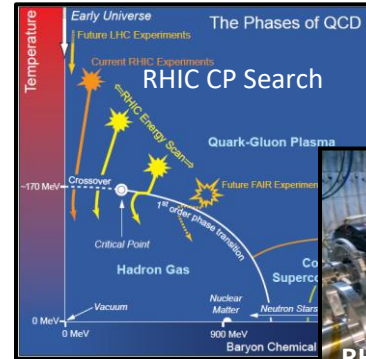

Nuclear Physics

FY 2020 Highlights

Projects: All baselined MIEs and Construction Projects are proceeding on cost and on schedule.

- GRETA procured 2 additional detector modules. CD-2 ESAAB achieved Oct 2020; TPC \$58.3M; FY20 \$6.6M
- sPHENIX continued detector component fabrication; TPC \$27M; FY20 \$9.5M
- MOLLER TPC (range) \$42M - \$61M; FY20 \$2.9M
- HRS received CD-1 in September 2020; TPC \$96.5M; FY20 \$1M
- FRIB construction continued according to the baseline profile; TPC \$730M; FY20 \$40M. Science starts in FY22
- Ton Scale DBD; FY21 Technology Down-select

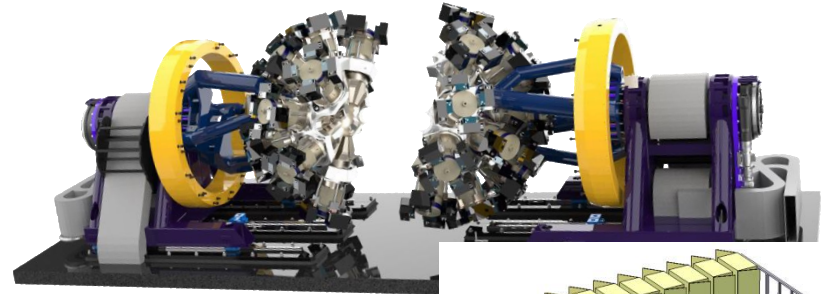

GRETA

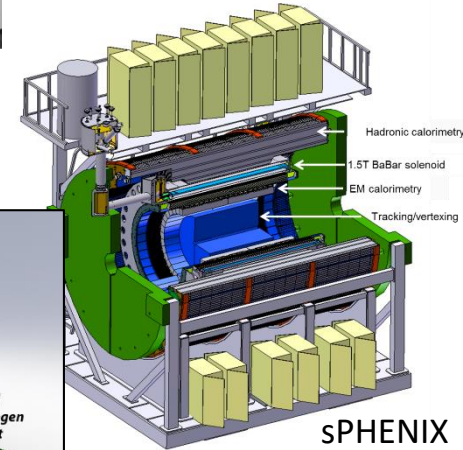

sPHENIX

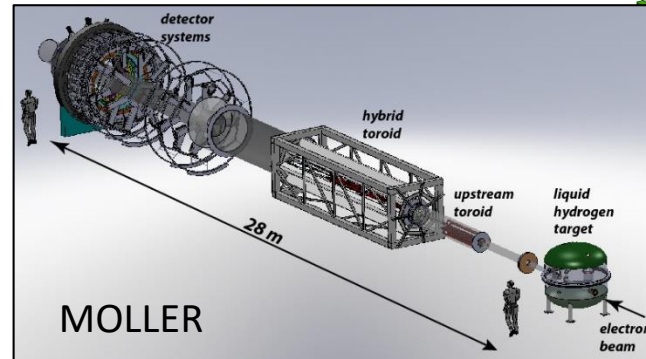

MOLLER



FRIB

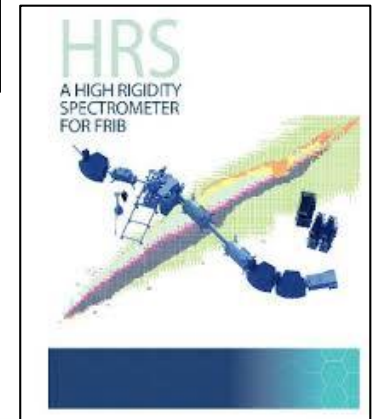

MOLLER: a “Must Do” Experiment To Point the Way to New Science

The scientific world rather desperately needs additional markers due to the consistency thus far of LHC data with Standard Model Predictions. Due to the technical challenge of constructing a next generation accelerator with very high accelerating gradients, those markers will have to come from “indirect” discovery experiments like MOLLER.

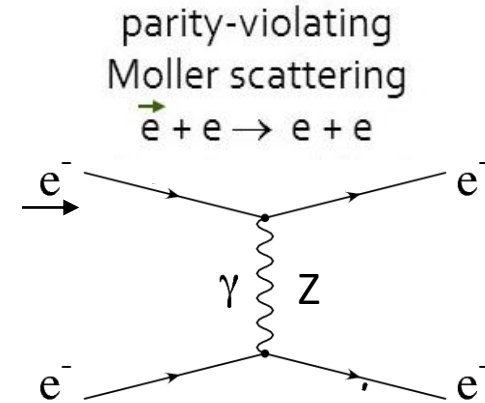
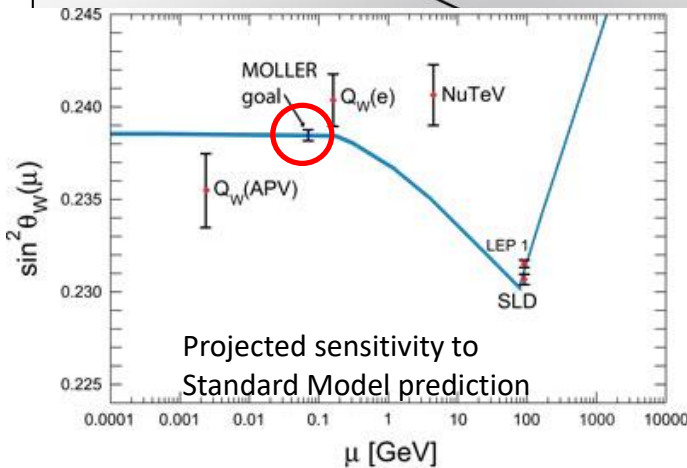
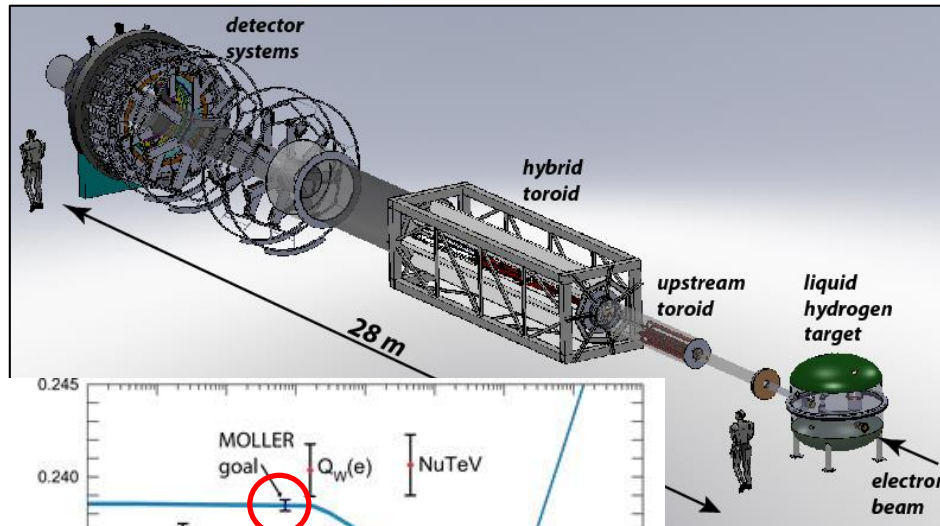

In MOLLER, polarized electrons are scattered off unpolarized electrons. The amount of parity violation due to interference of the two possible exchange mechanisms (γ or Z) is precisely predictable in QED. (No messy quarks or color charge, or QCD to worry about, only quantum electrodynamics). The theory is so “clean” that like the $g-2$ approach, if the level of parity violation is greater than expected, a new particle must be the source of the discrepancy.

FY 2020 Enacted: \$2M

Office of Science User Facilities

Number of User Facilities
28



FRIB First Experiments: Call for Proposals Issued

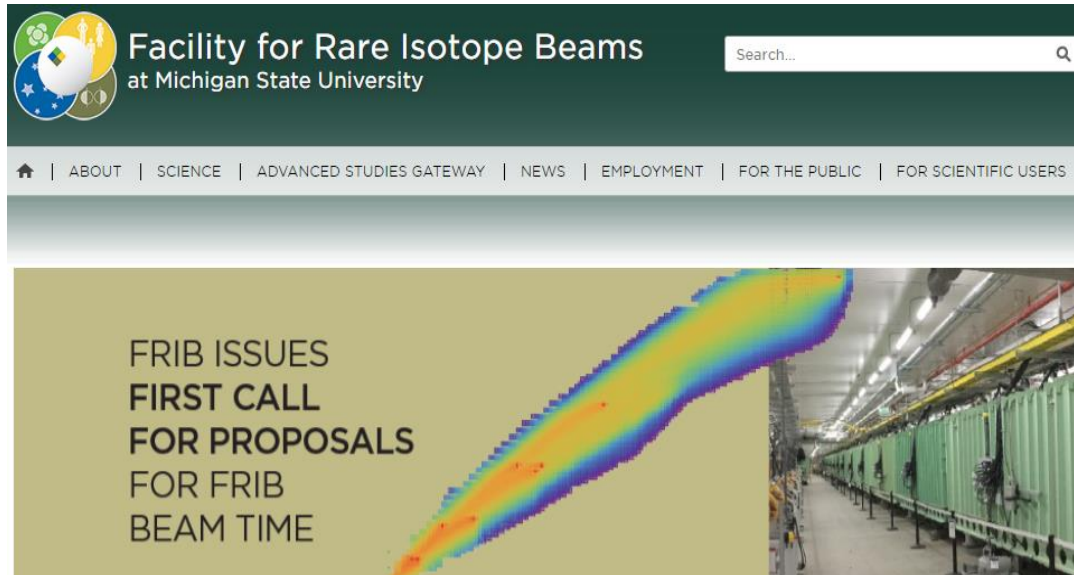

- November 2020 - Call for Proposals for FRIB PAC 1
- February 21, 2021 - Proposal submission deadline
- May 2021 - FRIB PAC1 Meeting
- Q1 2022 - First FRIB User Experiments

A May 4-8, 2020 workshop was held earlier to help users prepare outstanding proposals for the first FRIB Program Advisory Committee Meeting.

An overlapping FRIB Theory Alliance program and JINA-CEE program offered the opportunity to work with theorists and astrophysical modelers.

The FRIB Theory Alliance is “On the Way”



Theory Alliance
FACILITY FOR RARE ISOTOPE BEAMS

- to deliver excellent research in theory relevant to FRIB
- to serve as a focal point for **stimulating and continuous interactions between theory and experiment**, drawing theory activity toward those problems relevant for the science at FRIB;
- to **rejuvenate** the field by creating permanent positions in FRIB theory across the country;
- to **attract young talent** through the national FRIB Theory Fellow program;
- to strengthen theory in areas of most need;
- to foster **interdisciplinary collaborations** and build scientific bridges to wider theory communities;
- to coordinate a **sustainable educational program** in advanced low-energy nuclear theory;
- to coordinate **international initiatives** in the theory of rare isotopes.



FRIB Fellow and Bridge Programs

Fellow Program

- Diego Lonardoni (Hosting Institution: LANL; 2015-2020)
- Gregory Potel (Hosting Institution: MSU; 2016-2019, now staff at LLNL)
- Kevin Fosse (Hosting Institution: ANL; 2019 -)
- Chloe Hebborn (Hosting Institution: LLNL, 2020 -)
- Christian Drischler (Hosting Institution: MSU, 2020 -)

Currently calling for partners; new search will take place Fall 2020!

Bridge Program

- Saori Pastore (Institution: Wash U; start year 2018)
- Maria Piarulli (Institution: Wash U; start year 2018)
- Sebastian Konig (Institution: NCSU; start year 2020)
- TBD (Institution: FSU, search will take place Fall 2020)

Considering whether there is enough interest to send out a call later this year...

FRIB Theory Effort: A Future That Requires “Shades”



The FRIB Theory Alliance is working hard and very successfully to ensure there will be plenty of talented theory partners for the FRIB theory-experiment tango that is to come

The High Energy Nuclear Physics Frontier:
The Electron-Ion Collider



Independent Assessment of the EIC Science Goals

National Academy of Science Report: AN ASSESSMENT OF U.S.-BASED ELECTRON-ION COLLIDER SCIENCE

“An EIC can uniquely address three profound questions About nucleons—neutrons and protons—and how they are assembled to form the nuclei of atoms:

- How does the mass of the nucleon arise?
- How does the spin of the nucleon arise?
- What are the emergent properties of dense systems of gluons?”

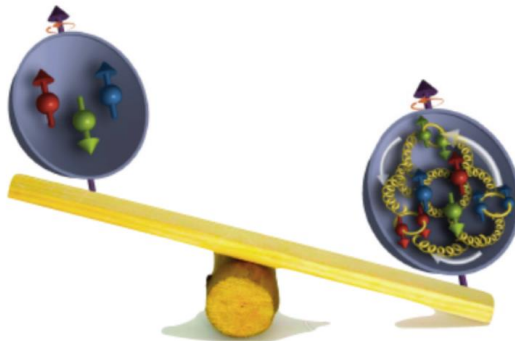
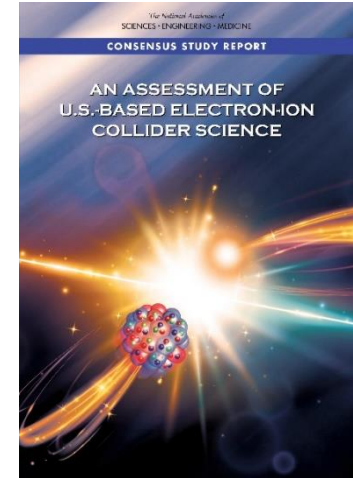

The EIC would be a unique facility & maintain leadership in nuclear science

The EIC would maintain leadership in the accelerator science and technology of colliders

EIC CD-0, Site Selection, Project Team Formation in FY20

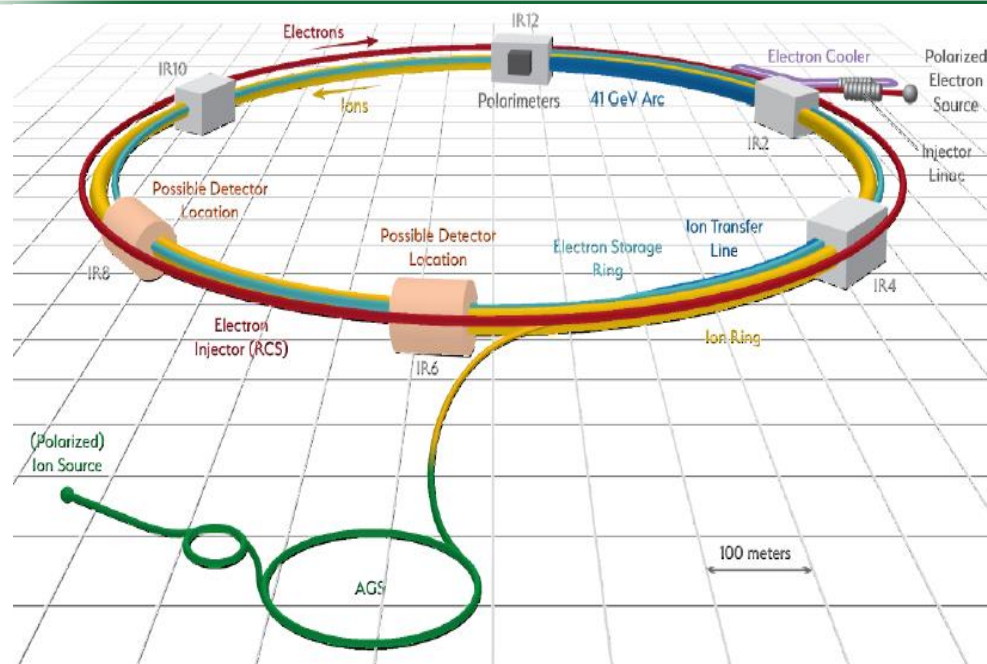

EIC scope includes the machine upgrade to RHIC asset and two interactions regions with one of the interaction regions outfitted with a major detector.

FY2020 \$1M TEC, \$10M OPC

The EIC will be located at BNL and with TJNAF as a major partner. The realization of the EIC will be accomplished over the next decade at an estimated cost between \$1.6 and \$2.6 billion.

Utilize existing operational hadron collider; add electron storage ring, cooling in existing RHIC tunnel and electron injector.

The EIC's high luminosity and highly polarized beams will push the frontiers of accelerator science and technology and provide unprecedented insights into the building blocks and forces that hold atomic nuclei together.

Working towards CD-1 in Q3 FY 2021

The EIC will be a game-changing resource for the international nuclear physics community. DOE looks forward to engaging with the international community and the international funding agencies about potential collaborations and contributions to the EIC effort, in nuclear, accelerator and computer science.

EIC Users Group and International Interest

- **Formed in 2016; currently:**
 - >1100 members
 - 205 institutions
 - 30 countries

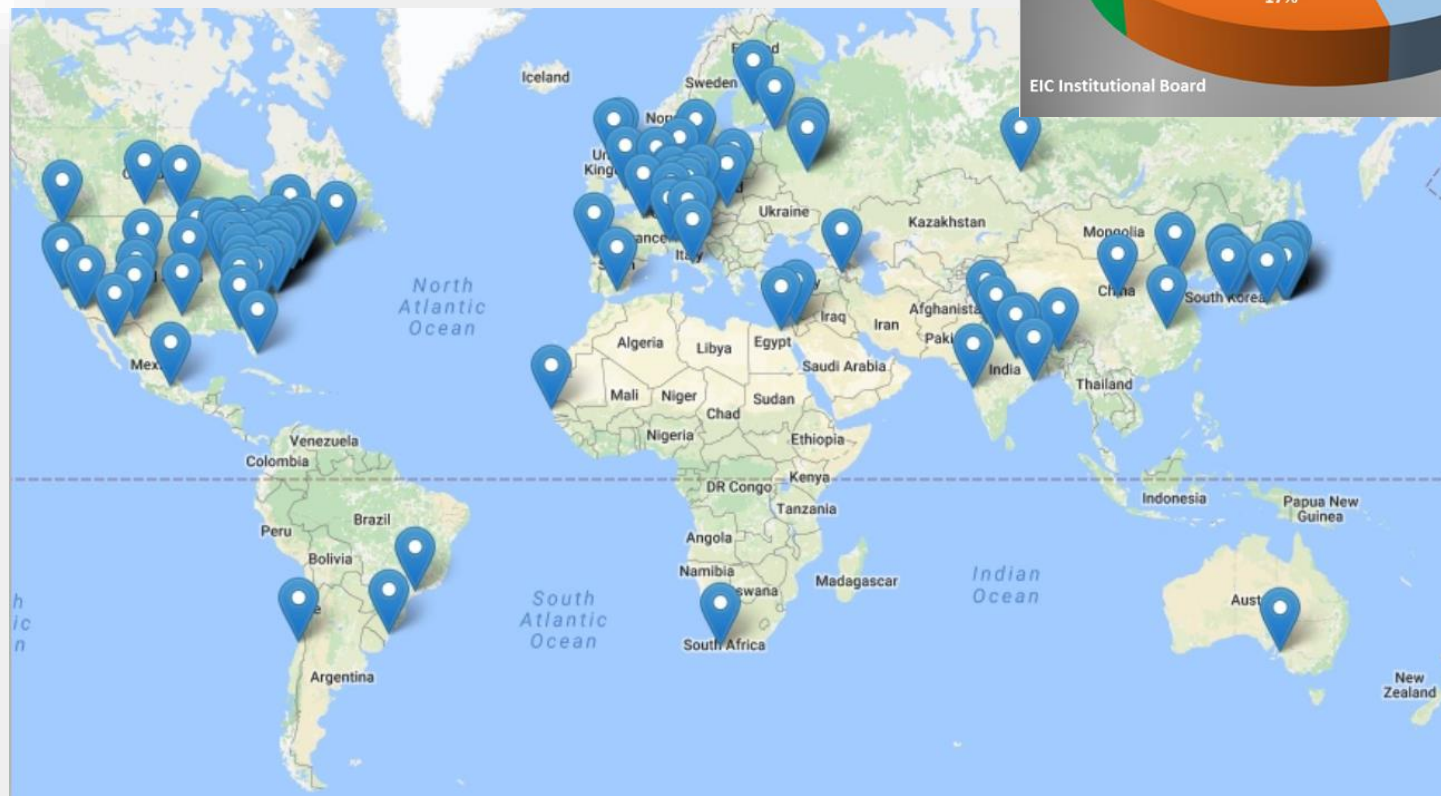
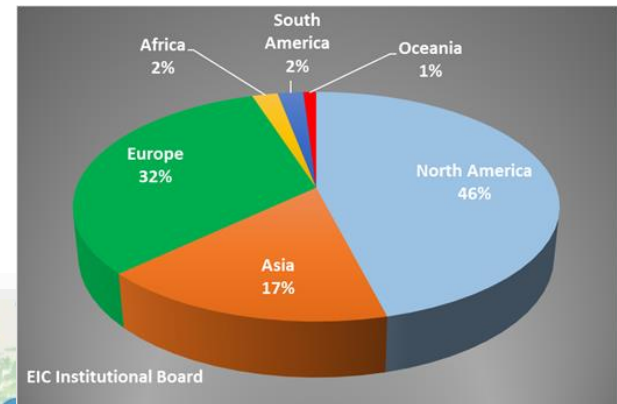

The Campaign to Determine the Fundamental Nature of the Neutrino

How can it be determined whether the neutrino is a Majorana Particle and why its mass is so small?

Search for Neutrino-less Double Beta Decay ($0\nu\beta\beta$): in a selected nucleus, two neutrons decay into two protons and two electrons, with no neutrinos being emitted.

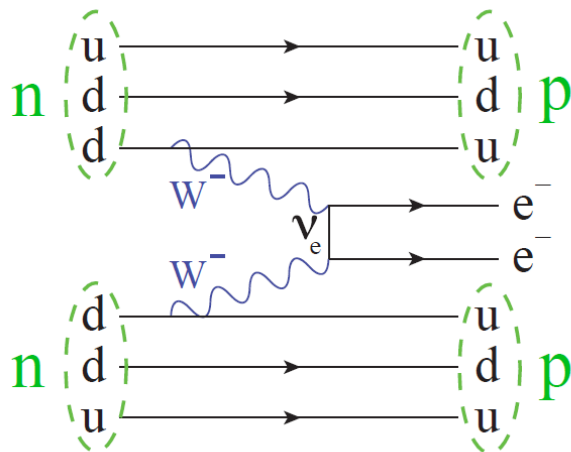

It can only happen if the two neutrinos from the two W^- particles annihilate internally because the neutrino is its own anti-particle

Scientists have been eagerly working to demonstrate the necessary sensitivity



- TeO₂ from CUORE and CUOREcino
1.5 × 10²⁵ years, 90% CL
- Ge⁷⁶ from Majorana Demonstrator
1.9 × 10²⁵ years, 90% CL
- Ge⁷⁶ from GERDA
8.0 × 10²⁵ years, 90% CL
- Xe¹³⁶ from EXO-200
1.8 × 10²⁵ years, 90% CL
- Xe¹³⁶ from Kamland-Zen
1.1 × 10²⁶ years, 90% CL

FY 2020 Enacted: \$1M

Ton Scale Stewardship: SC NP

Future Decisions TBD

Three Front-Runner Technologies

- Scintillating bolometry (**CUPID**, ^{100}Mo enriched Li_2Mo_4 crystals)
- Enriched ^{76}Ge crystals (**LEGEND-1000**, drifted charge, point contact detectors)
- Liquid Xenon TPC (**nEXO**, light via APD, drifted ionization)

Background constraints are exceptionally challenging ~ 1 count/ton of material/year

Current research projects feasibility at the level of 0.3 counts/ton of material/year sufficient to reach the 10-15 meV region just below the inverted hierarchy

Also, must choose between possible sites

- SURF (SD)
- SnoLab (Canada)
- Gran Sasso (Italy)

CUORE: Towards CUPID Ton-scale NLDBD Search

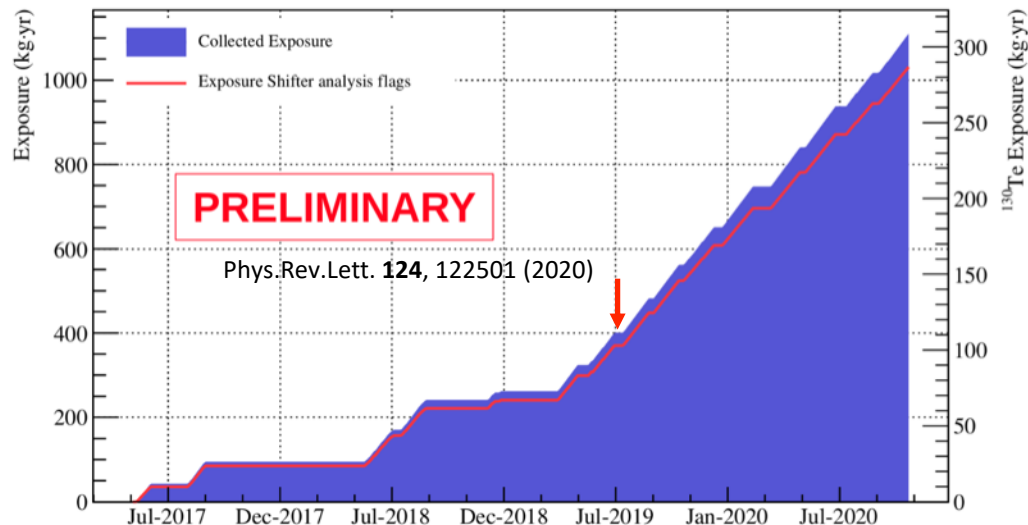
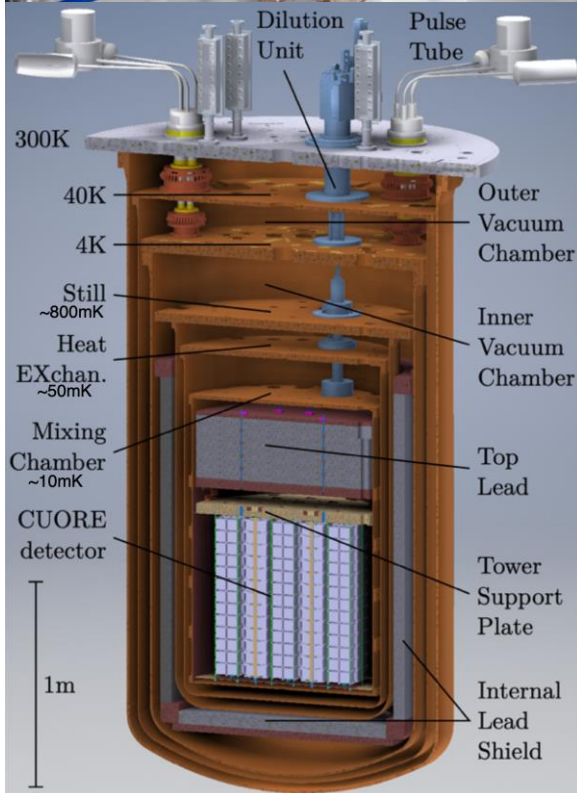
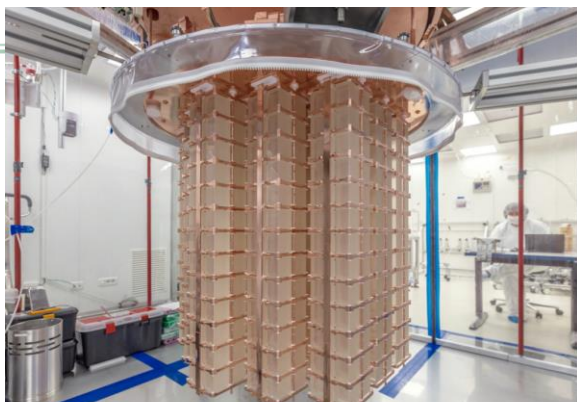

Collected TeO_2 exposure: 1110 kg*year

Analyzable exposure: 1031 kg*year (*as of Oct 26, 2020)

>1 ton*year analyzable exposure

Largest dataset ever collected by a solid-state double-beta decay experiment

Continuous operations at 11mK since March 2019

Demonstrates readiness for a ton-scale bolometric double-beta decay experiment

CUPID proceeding to technical design



U.S. DEPARTMENT OF
ENERGY

Office of
Science

nEXO Concept

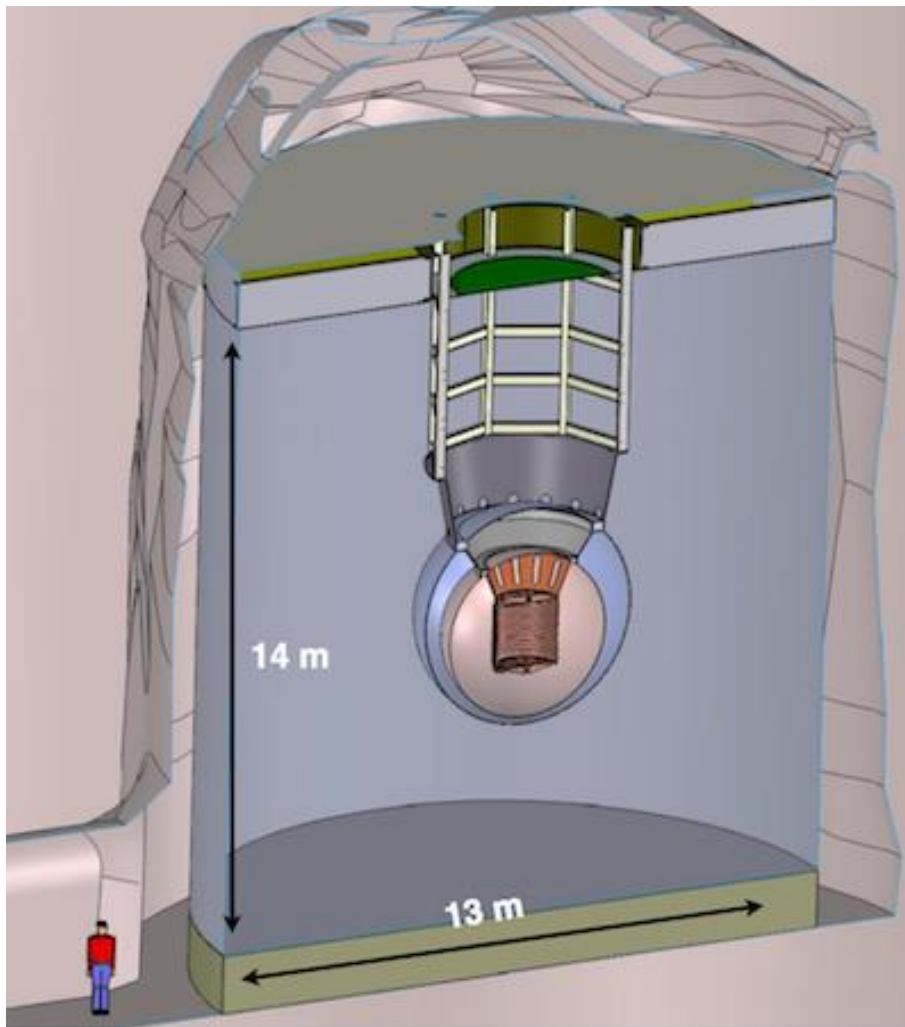

Artist rendering of the nEXO TPC (right) and its installation at the SNOLAB cryopit (left). The cryostat is submerged in a water tank which acts as active shielding. SiPMs will be mounted between field shaping rings and detector wall.

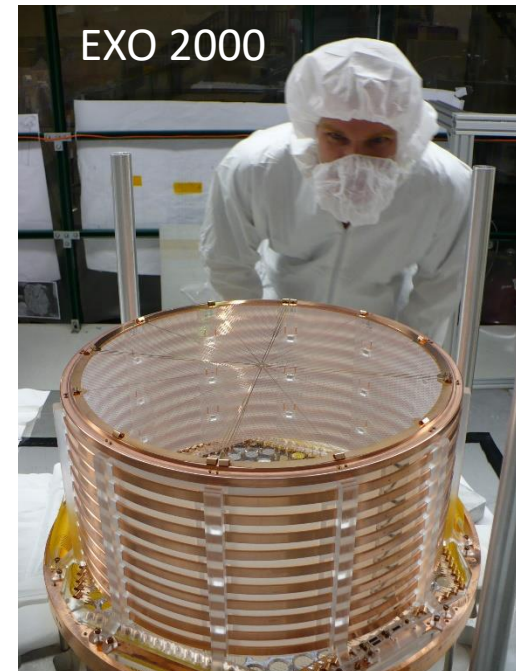

LEGEND-1000

The concept for LEGEND-1000 showing a number of the deployments Ge detectors. This cut-away view shows three of five 200-kg groupings of Ge.

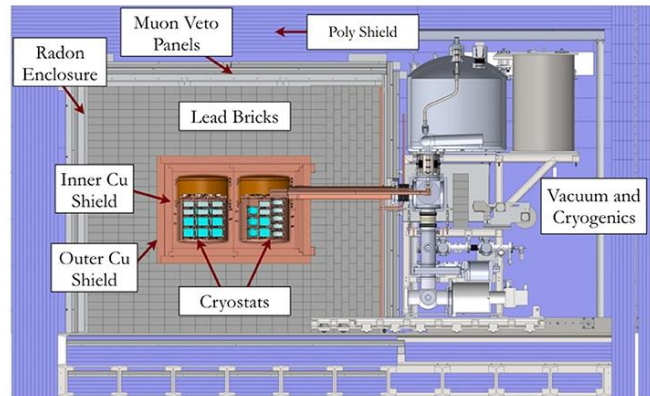
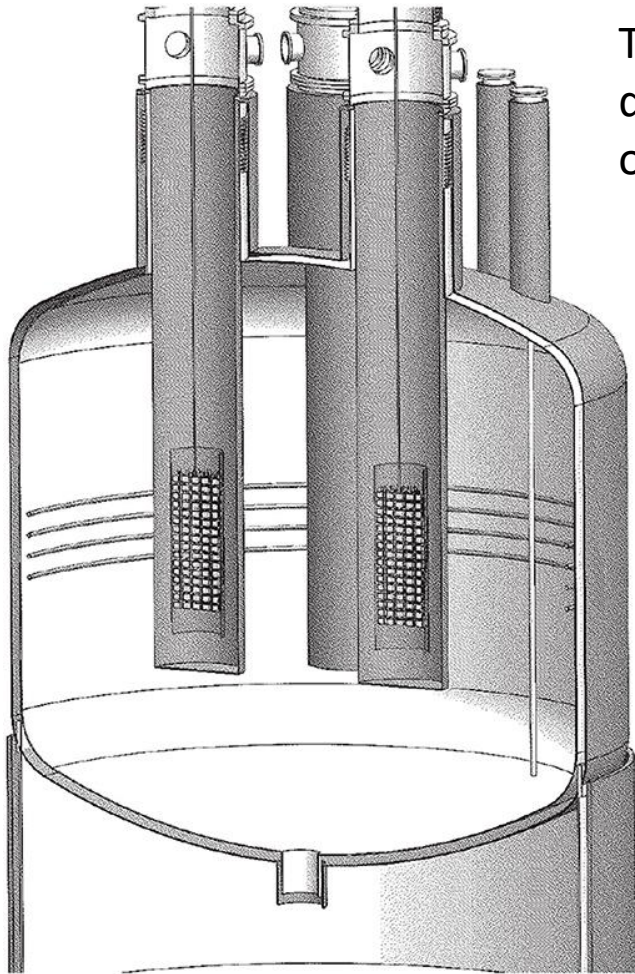

Majorana Demonstrator

+

GERDA

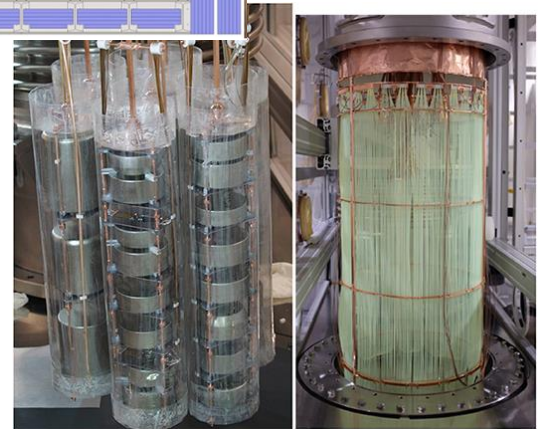

Notional Schedule

Critical Decision (CD)	Dates
<i>CD-0, Approve Mission Need</i>	11/01/2018 (Actual)
<i>CD-1/3A Approve Alternative Selection and Cost Range and Long Lead Procurement</i>	FY 2022 (Planned)
<i>CD-2, Approve Performance Baseline</i>	TBD
<i>CD-3, Approve Start of Construction</i>	TBD
<i>CD-4, Approve Project Completion</i>	TBD

- Other than CD-0, “planned” dates are subject to progress in selecting a preferred technology as well as the availability of funding.
- The cost range for U.S. leadership of a ton-scale neutrino-less double beta decay experiment approved at CD-0 in 2018 was **\$215 – 250** million, depending on the chosen technology. With delays in the project, the cost range is expected to increase.

$0\nu\beta\beta$ Progression

- Monthly Technical Updates with LEGEND-100, nEXO, and CUPID
- Ongoing introductions via telecon with potential funding agency stakeholders to introduce U.S. perspectives, hear European perspectives, and suggest a global approach to investment in DBD science
- DBD portfolio review exercise will be held April 2021 to inform U.S. investment strategy
- A followup North American – European Summit being planned to see if common ground exists for an international approach to DBD investment
- Funding for ton-scale $0\nu\beta\beta$ is going to be challenging

Big Picture, NP Excitement

Nuclear physics is poised to potentially revolutionize current understanding of the physical universe. Why?

- The convergence of the Electron-Ion Collider and Quantum Computing. One will illuminate how nature creates mass, the other will enable solutions of the theory governing the strong force for many body systems: a.k.a. Quantum field theory. QCD will become an exact science like QED is now.
- The convergence of the Facility for Rare Isotope Beams and data analytics enabling predictive modeling. One will produce 80% of all isotopes in nature, including over 1000 never produced on earth, the other will identify correlations between nuclear structure and atomic properties leading to predictive, analytical capability for isotopes that may never be terrestrially accessible. The origin of heavy element synthesis in the cosmos will be fully revealed.
- The convergence of exquisite, low-background double beta decay experiments will determine if the neutrino is its own antiparticle, and potentially point the way to a (thus far) unseen sub-atomic zoo.

New SC Org Chart

Office of Science

04/13/2020

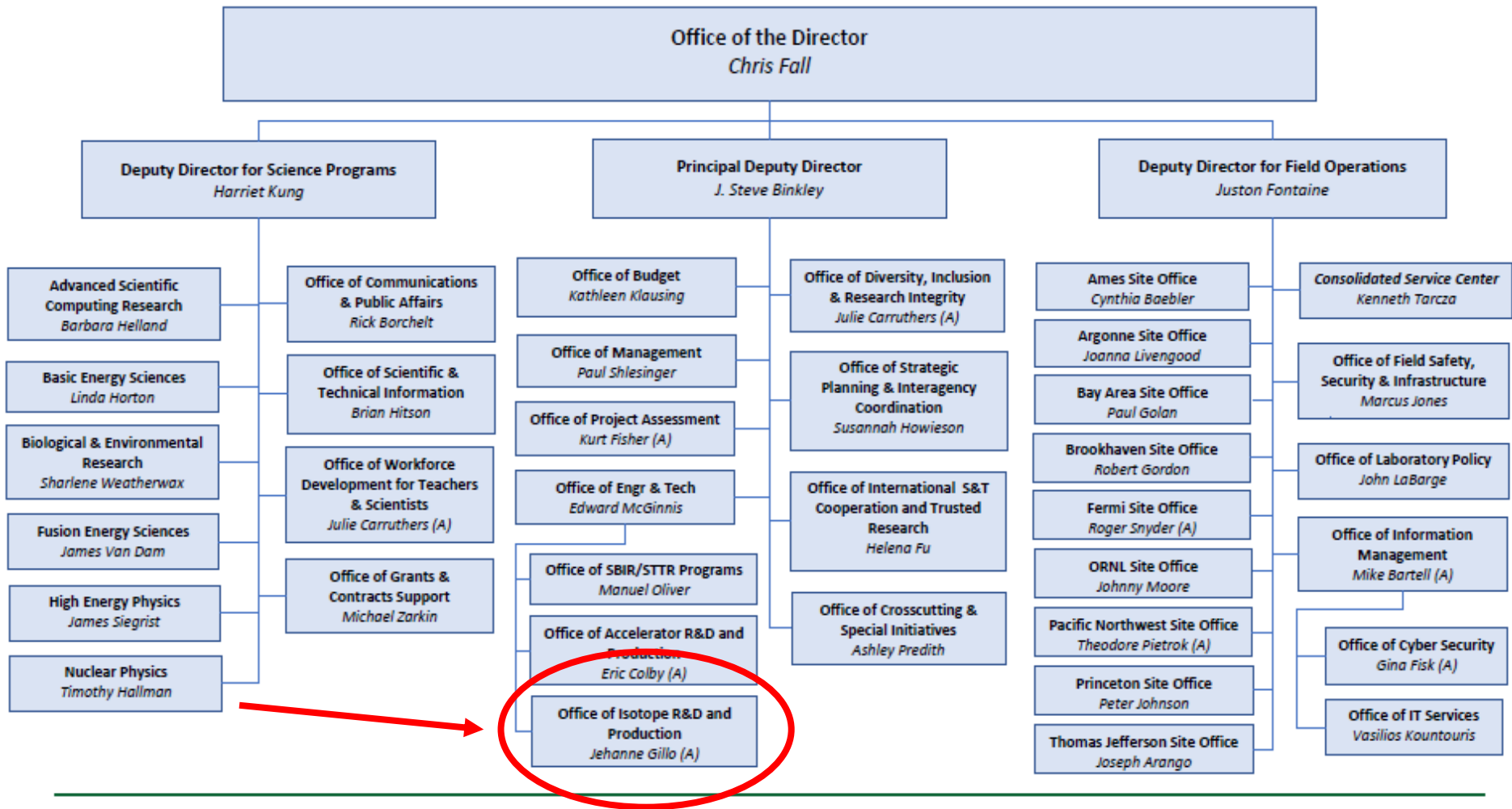

Nuclear Physics

FY 2020 Highlights

- ***A Landmark Advance on the Road to Quantum Computing***— Nuclear physicists from MIT, PNNL discover that ionizing radiation from environmental radioactive materials, contaminants and cosmic rays can limit superconducting qubits to coherence times in the millisecond regime—far too short for practical quantum computing. This indicates the need to mitigate such effects.
- ***Mass Limits on the Elusive Neutrino Cut in Half***— Nuclear physicists working on the KATRIN experiment (UW, UNC, MIT, CMU, LBNL) cut the upper bound on the neutrino mass in half, demonstrating that the wispy neutrino mass is no more than the energy equivalent of one electron volt (eV)— five-hundred-thousand times less than the mass of an electron. As the existence of neutrino mass contradicts a prediction of the Standard Model of particle physics, knowing its value opens a window to discovering new physics. Over the next 5 years, KATRIN is expected to further improve its sensitivity by a factor of 5



New PREX Results Unblinded !

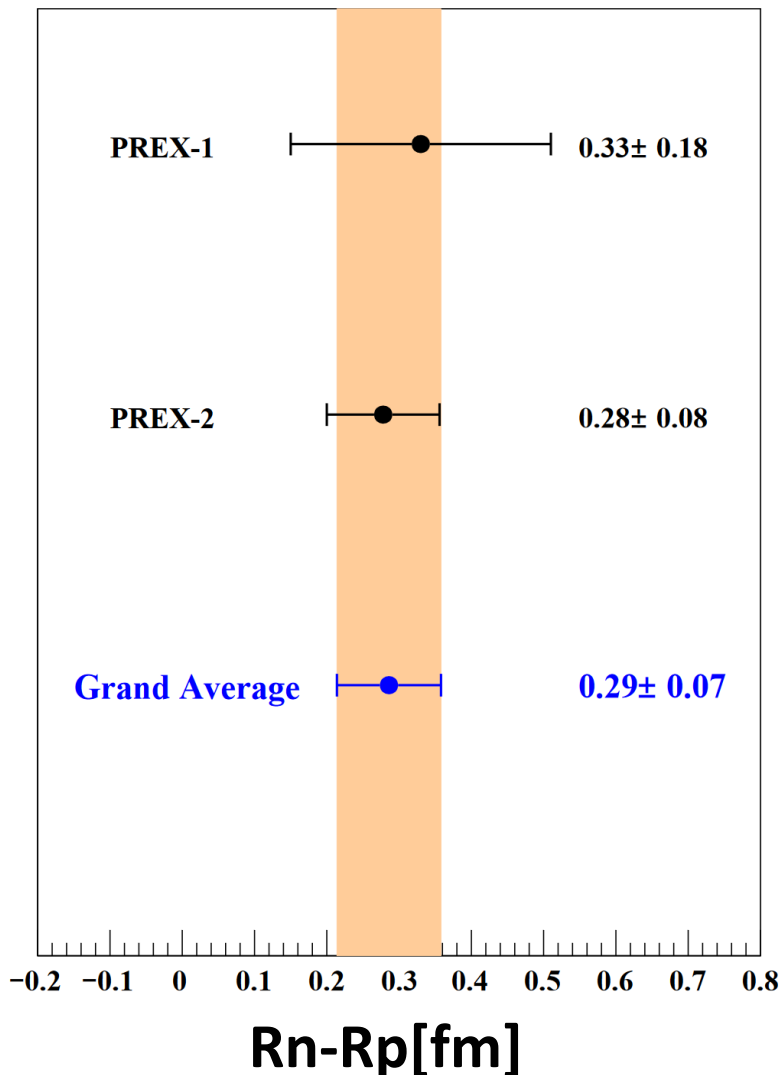

- The weak radius can be combined with the well-known charge density to obtain the baryon density of ^{208}Pb
- This is the first clean determination of the central baryon density of a heavy nucleus and is accurate to 2%
- Provides an important benchmark to chiral EFT calculations that is closely related to nuclear saturation density
- Result has direct relevance for bounding the radius of neutron stars in concert with neutron star merger data from LIGO



High Level Assessment

The program has approval to build a suite of new tools, big and small, which if successfully constructed promise discoveries and world leading science “as far as the eye can see”

A host of exciting new initiatives are being opened up, many with serious implications for U.S. competitiveness and security

Nuclear Physics is able to pursue a significant participation in several of these initiatives (QIS, AI, Strategic Accelerator)

Erosion of resources to pursue core research is a continuing concern. The balance between research, projects, and facility operations needs to be watched

Thus far the community is staying resilient and focused, continuing to deliver important outcomes for the nation: exciting discoveries, important scientific knowledge, technological advances, and workforce training

The current situation with COVID-19 holds a number of lessons which must be lasting
