

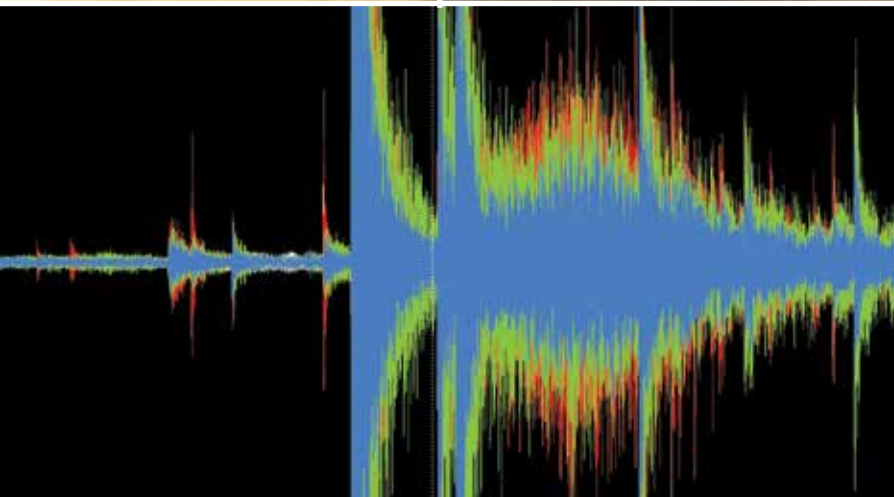

The U.S. Magnet Development Program Plan

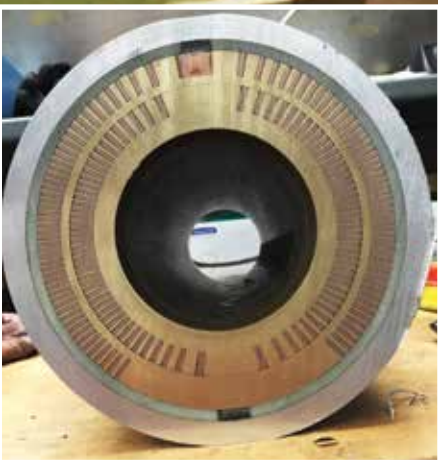
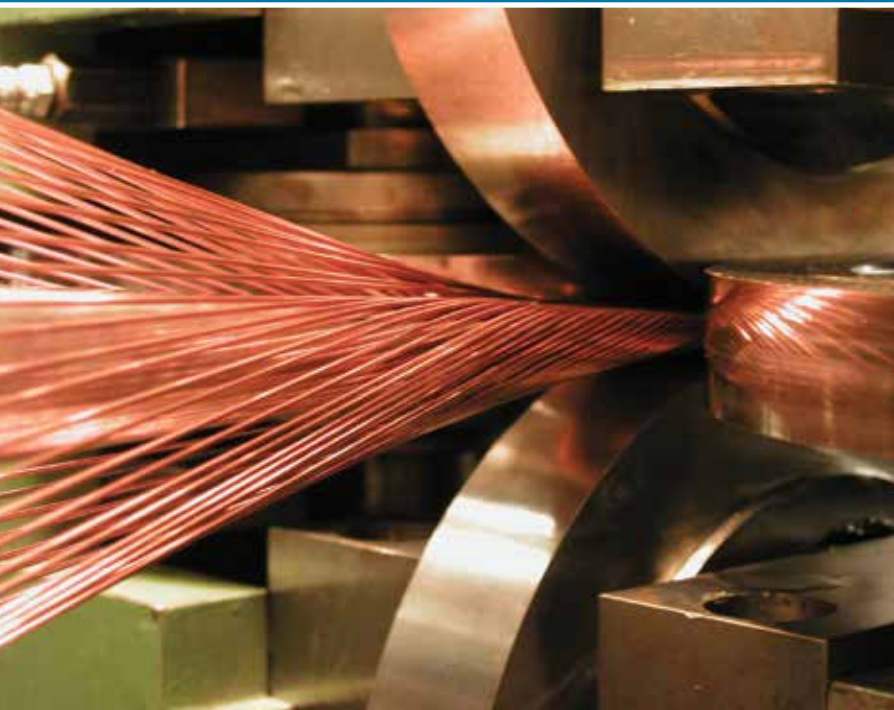

S. A. Gourlay, S. O. Prestemon
*Lawrence Berkeley National Laboratory
Berkeley, CA 94720*

A. V. Zlobin, L. Cooley
*Fermi National Accelerator Laboratory
Batavia, IL 60510*

D. Larbalestier
*Florida State University and the
National High Magnetic Field Laboratory
Tallahassee, FL 32310*

JUNE 2016



Table of Contents

Executive Summary	3
Introduction	4
1. The U.S. Magnet Development Program	7
2. The MDP Program and Scope of Work	8
2.1 The MDP Directions and Deliverables to Achieve the MDP Goals	10
2.2 High Field Dipole Development to Explore the Limits of Nb ₃ Sn	10
2.3 High Field Magnet Development to Explore the Limits of HTS	13
2.4 Magnet Science: Developing Underpinning Technologies	16
2.5 Superconducting Materials – Conductor Procurement and R&D (CPRD)	18
3. Schedule and Milestones	20
3.1 Schedule and Milestones	20
4. The MDP Management Plan	24
4.1 The MDP Leadership and Management Structure	24
References	27
Appendices	30
Appendix A: Motivation for the MDP	30
Appendix B: HEPAP Recommendations	32
Appendix C: Acronyms and Abbreviations	33
Appendix D: DOE MDP Creation Guidance Memo	34



S.A. Gourlay
Lawrence Berkeley
National Laboratory



S.O. Prestemon
Lawrence Berkeley
National Laboratory



A.V. Zlobin
Fermi National
Accelerator Laboratory



L. Cooley
Fermi National
Accelerator Laboratory



D. Larbalestier
Florida State University and
the National High Magnetic
Field Laboratory

Executive Summary

The 2014 Particle Physics Project Prioritization Panel (P5) Report identified a critical need for transformational high field magnet R&D focused on substantially increasing performance and lowering the cost per T-m. This need was subsequently reiterated in the HEPAP* Accelerator R&D subpanel report.

In response, the DOE Office of High Energy Physics has initiated an ambitious program, coordinated by LBNL (see Appendix A), to aggressively pursue the development of superconducting accelerator magnets that operate as closely as possible to the fundamental limits of superconducting materials and at the same time minimize or eliminate magnet training. The U.S. Magnet Development Program (MDP) is based on four goals that summarize the P5 and Subpanel recommendations.

These goals will be achieved by focusing on high field dipole development along four elements. The first element aims at the establishment of a baseline design to demonstrate feasibility of 16 T magnets and the development of higher risk innovative concepts to improve performance and reduce cost. The second element is to assess the feasibility of accelerator magnets based on HTS materials. The third element consists of a supporting program of science and technology development that serves as the core of the MDP. This component will provide a means of exploring new design concepts, instrumentation, diagnostics and fabrication techniques in a controlled and cost-effective way. The model magnets will serve as platforms for integration of the results of these ongoing activities. A fourth element, a conductor development program that challenges existing strand and cable performance parameters and is driven by the magnet R&D goals, supports these main elements.

The program is focused on transformational magnet technologies, leveraging the significant experience base developed in the magnet programs while incorporating a strong science-based element to address limitations to magnet performance. Success will rely upon a collaborative effort of U.S. national labs, industry and universities that takes maximum advantage of existing infrastructure and expertise at the participating institutions by combining and coordinating intellectual and infrastructure resources. This document defines the motivation for the scientific and technological goals, the MDP scope, milestones and timeline for delivering results, and funding and resources needed to execute the program.

Through the work outlined here we will advance high-energy physics while increasing our own capabilities in accelerator magnet technology. This will position the U.S. for a leadership position in the development of enabling technology for the next generation of very high energy proton-proton colliders and, in the nearer term, establish a technology base for a possible energy upgrade of the LHC. As an HEP funded Program, the primary focus is on magnets for accelerators, but the generic approach will develop magnet technologies that can be applied to a large variety of applications across the DOE Office of Science and beyond.

US Magnet Development Program (MDP) Goals:

GOAL 1:

Explore the performance limits of Nb_3Sn accelerator magnets with a focus on minimizing the required operating margin and significantly reducing or eliminating training.

GOAL 2:

Develop and demonstrate an HTS accelerator magnet with a self-field of 5 T or greater compatible with operation in a hybrid LTS/HTS magnet for fields beyond 16 T.

GOAL 3:

Investigate fundamental aspects of magnet design and technology that can lead to substantial performance improvements and magnet cost reduction.

GOAL 4:

Pursue Nb_3Sn and HTS conductor R&D with clear targets to increase performance and reduce the cost of accelerator magnets.

* HEPAP: High Energy Physics Advisory Panel

Introduction

Interest in the next generation of hadron colliders as one of the main discovery tools for the future of high-energy physics has been evolving rapidly. There are growing activities toward development of machine designs at CERN (Future Circular Collider — FCC) [1], encouraged by the 2013 EU Strategy Update, and in China (Super proton-proton Collider — SppC) [2]. In the US, the recent Particle Physics Project Prioritization Panel (P5) [3] has strongly supported a future high-energy proton-proton collider as part of an overall strategy.

Subsequently, the DOE Office of High Energy Physics commissioned a High Energy Physics Advisory Panel (HEPAP) subpanel [4] to advise on medium and long term national goals for US Accelerator R&D in accelerator based particle physics consistent with the P5 report.

The P5 report states, “A very high-energy proton-proton collider is the most powerful future tool for direct discovery of new particles and interactions under any scenario of physics results that can be acquired in the P5 time window.” The report also states, “The U.S. is the world leader in R&D on high-field superconducting magnet technology, which will be a critical enabling technology for such a collider.” In light of these observations, the P5 strategic plan endorses medium-term R&D on high-field magnets and materials in the context of its recommendation 24: “Participate in global conceptual design studies and critical path R&D for future very high-energy proton-proton colliders. Continue to play a leadership role in superconducting magnet technology focused on the dual goals of increasing performance and decreasing costs.” The Subpanel strongly supported this direction through a number of specific recommendations, which can be found in Appendix B.

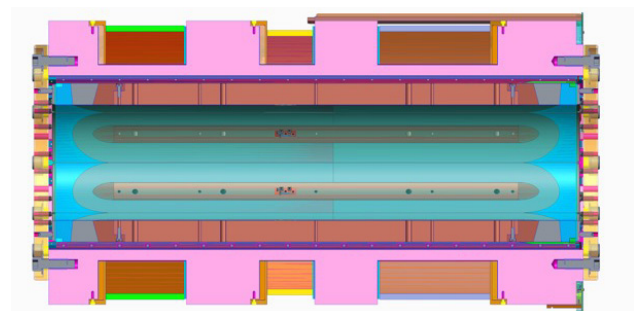
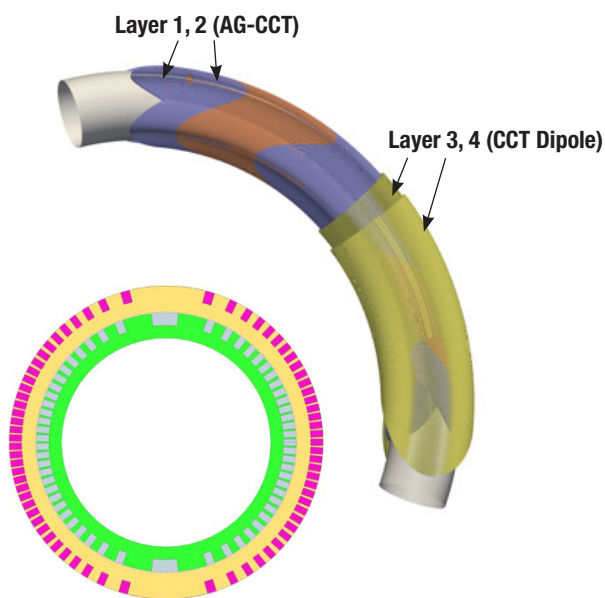

This document outlines an ambitious, internationally competitive program to develop accelerator magnets with operating fields that exceed existing LHC dipole magnets at least by a factor of two while substantially reducing the cost per tesla-meter. It will reassert U.S. leadership in high field accelerator magnet technology by aggressively pushing the limits of magnets and materials to extreme levels of performance. We describe here the guiding vision; the specific goals; the general plan and scope of work; a preliminary estimate of the resources necessary to carry out the work within a reasonable schedule; and a management plan to guide the work, measure progress and make program adjustments. Executing the plan put forth here, we will advance high-energy physics while increasing our own capabilities in accelerator magnet technology that will position the U.S. to be able to lead in the development of enabling technology for the next generation of very high energy proton-proton colliders or, in the nearer term, establish a technology base for a possible energy upgrade of the LHC. As an HEP funded Program, the primary focus is on magnets for accelerators, but the generic approach will develop magnet technologies that can be applied to a large variety of applications. These include: low-temperature and high-temperature superconducting magnets for particle beam therapy [5], high field magnet systems for ECR* ion sources [6,7], superconducting undulators to improve the performance of light sources, very high field HTS* magnets for future fusion reactors [8] and research magnets as described in the recent MagSci Report [9]. Examples of some current and future applications are shown in Figure 1.

* ECR: Electron Cyclotron Resonance
HTS: High Temperature Superconductor

Figure 1. From left to right:
a) Superconducting medical gantry magnet, an HEP Stewardship project performed in close collaboration with a US industrial partner, b) ECR magnet for Facility for Rare Isotope Beams (FRIB), c) Nb_3Sn superconducting undulator, developed in collaboration with ANL and SLAC, d) high field tokamak concept.

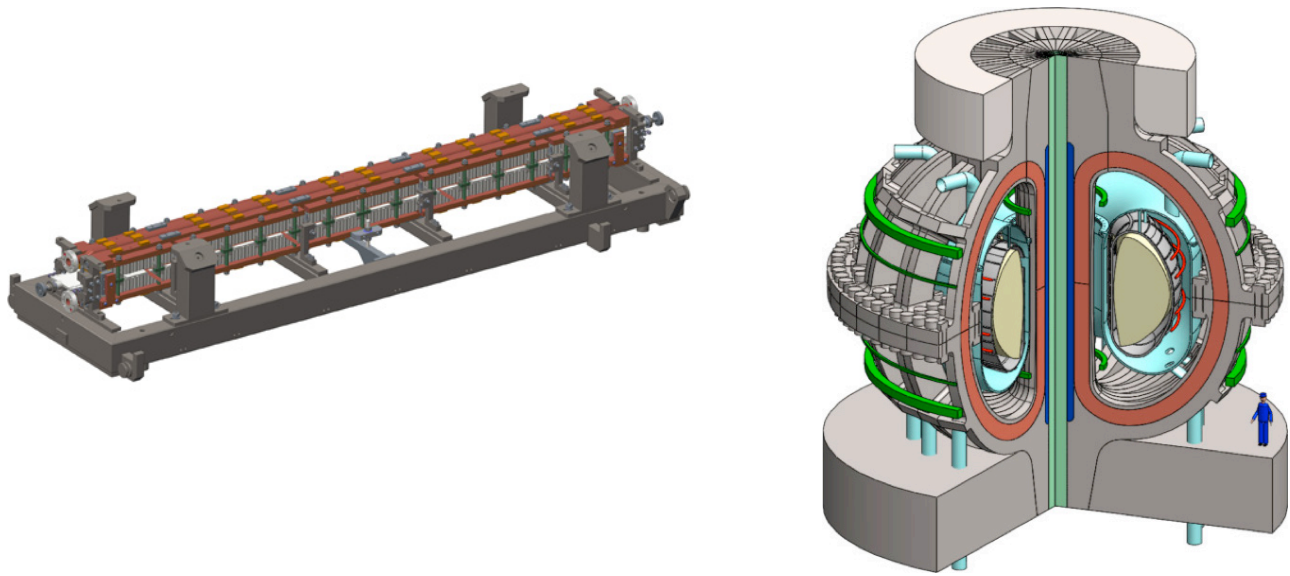

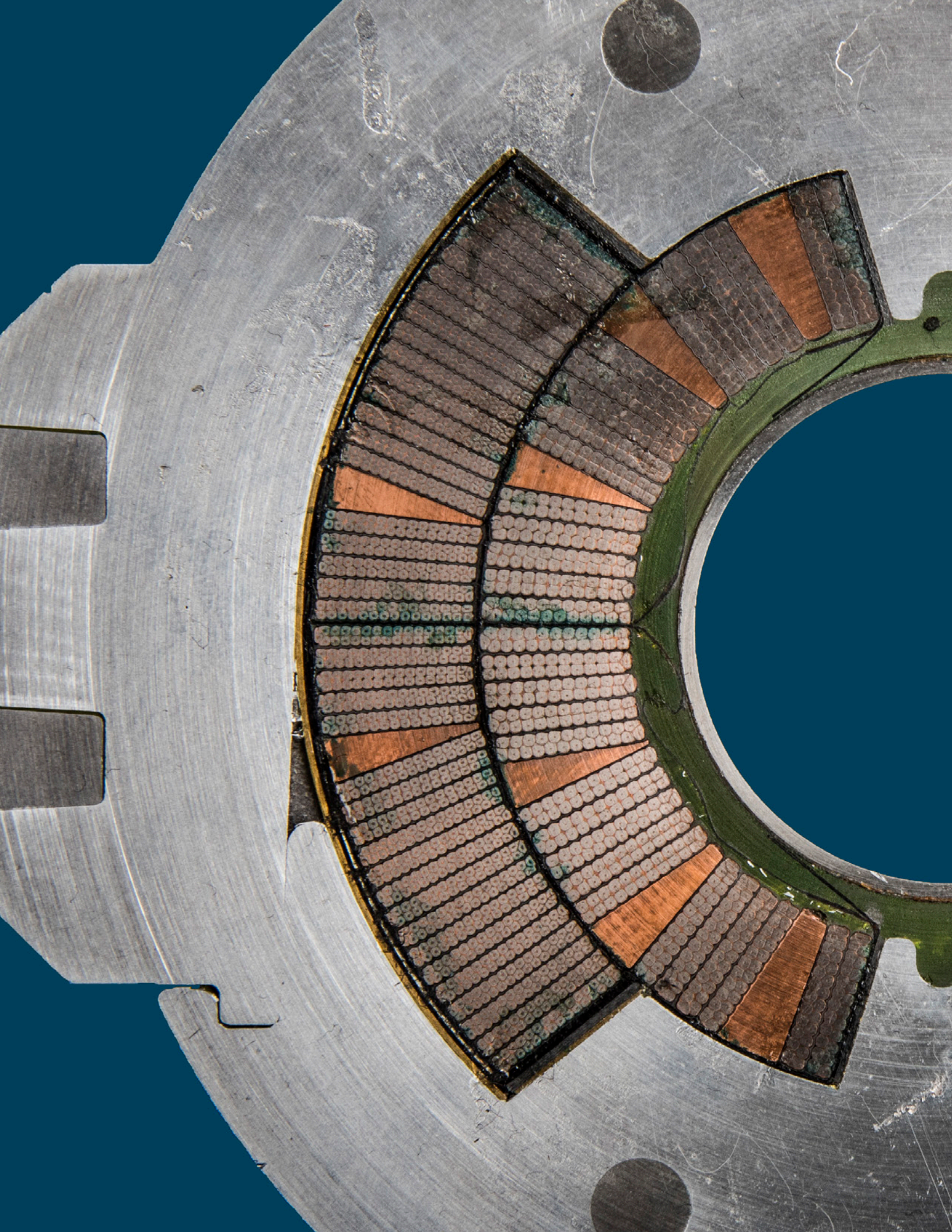

The U.S. Magnet Development Program

The U.S. national laboratories, industries and university programs, supported by DOE-HEP, provided critical contributions to the advancement of superconducting accelerator magnet technologies during the past four decades. The impressive achievements of U.S. accelerator magnet R&D include world records in field strength and field gradient of magnets, successful technology industrialization and application in practical accelerators, and growth of the world's largest superconductor industry in the USA. Superconducting NbTi magnets are the essential components of the Tevatron, HERA*, RHIC*, and most recently the LHC* [10,11]. The development of Nb₃Sn accelerator magnets by the General Accelerator R&D (GARD) programs and the outstanding success of the LHC Accelerator Research Program (LARP) in moving that technology to practical use in the LHC luminosity upgrade project are the most recent examples of U.S. contributions to the worldwide pursuit of high energy physics. And yet, there is a critical need for innovation that will result in increased magnet performance at lower cost. This was expressed in the HEPAP P5 and Accelerator R&D subpanel reports.

We next detail the necessary program scope to achieve these goals through the newly formed Magnet Development Program (MDP).

The HEPAP subpanel individual recommendations and the DOE guidance are expressed by the following broad program goals:

GOAL 1:

Explore the performance limits of Nb₃Sn accelerator magnets with a focus on minimizing the required operating margin and significantly reducing or eliminating training.

GOAL 2:

Develop and demonstrate an HTS accelerator magnet with a self-field of 5 T or greater compatible with operation in a hybrid LTS/HTS magnet for fields beyond 16 T.

GOAL 3:

Investigate fundamental aspects of magnet design, technology and performance that could lead to substantial performance improvements and reduction of magnet cost.

GOAL 4:

Pursue Nb₃Sn and HTS conductor R&D with clear targets to increase performance and reduce the cost of accelerator magnets.

* HERA: Hadron-Elektron Ring Anlage (facility)
RHIC: Relativistic Heavy-Ion Collider
LHC: Large Hadron Collider

2.

The MDP Program and Scope of Work

The Program Goals will be achieved by a program that strives to answer the Driving Questions provided in Table 1. The following section outlines the structure of the Magnet Development Program, designed to achieve the program goals and address the driving questions.

TABLE 1: Driving Questions

Driving questions related to the <i>ultimate performance limits of high-field accelerator magnets</i>	
1	What is the nature of accelerator magnet training? Can we reduce or eliminate it?
2	What are the drivers and required operation margin for Nb ₃ Sn and HTS accelerator magnets?
3	What are the mechanical limits and possible stress management approaches for Nb ₃ Sn and 20 T LTS/HTS magnets?
4	What are the limitations on means to safely protect Nb ₃ Sn and HTS magnets?
Driving questions related to <i>cost and operational considerations of high-field accelerator magnets</i>	
5	Can we provide accelerator quality Nb ₃ Sn magnets in the range of 16 T?
6	Is operation at 16 T economically justified? What is the optimal operational field for Nb ₃ Sn dipoles?
7	What is the optimal operating temperature for Nb ₃ Sn and HTS magnets?
8	Can we build practical and affordable accelerator magnets with HTS conductor(s)?
9	Are there innovative approaches to magnet design that address the key cost drivers for Nb ₃ Sn and HTS magnets that will shift the cost optimum to higher fields?
Driving question related to <i>conductor development for high-field accelerator magnets</i>	
10	What are the near and long-term goals for Nb ₃ Sn and HTS conductor development? What performance parameters in Nb ₃ Sn and HTS conductors are most critical for high field accelerator magnets?



2.1 The MDP Directions and Deliverables

The Program is composed of four primary elements. The first element consists of high field dipole research and development that is organized into two components. One is establishment of a baseline design to demonstrate feasibility and the second is aimed at higher risk innovative concepts to reduce cost. The second element is to generically evaluate the feasibility of high field accelerator magnets based on HTS materials. The Program is supported by a third element of essential underlying generic magnet science and technology development. The model magnets will serve as platforms for integration of the results of these ongoing activities. These main elements are supported by a fourth element: a conductor development program that will expand performance parameters of existing Nb_3Sn and HTS composite strands and cables that is driven by the magnet R&D goals. Due to the R&D nature of the program, we project milestones for the first three years of the program; future milestones will depend on progress and possible down-select decisions based on review of program performance.

2.2 High Field Dipole Development to Explore the Limits of Nb_3Sn

Directions and Deliverables

Magnets with a small bore or no bore have reached 16 T in the US and recently at CERN. Modeling indicates that this is close to the “practical” limit for currently available high performance Nb_3Sn wire. The remaining challenge is to realize this potential in accelerator quality magnets, both in magnets with small aperture, typical of high energy colliders, and in magnets with larger aperture, to provide background field for HTS inserts. We aim to demonstrate the feasibility of a magnet with a bore field of 16 T (at 90% of the conductor limit) with a bore greater than or equal to 50 mm with two complementary approaches:

- **A reference design based on the well-known cosine-theta concept** (see Figure 2). The last high-field record Nb_3Sn cosine-theta magnet was the LBNL D20, which reached 13.5 T at 1.9 K [12]. Since then, conductor J_c has more than doubled, and a mechanical

Figure 2. *Left:* Cross section of 15 T cosine-theta dipole. *Right:* Support structure for the concept.

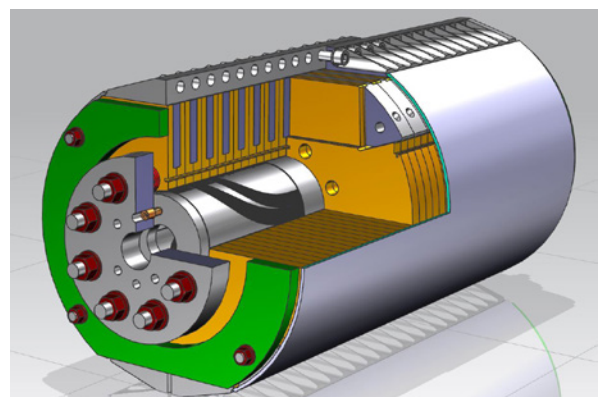
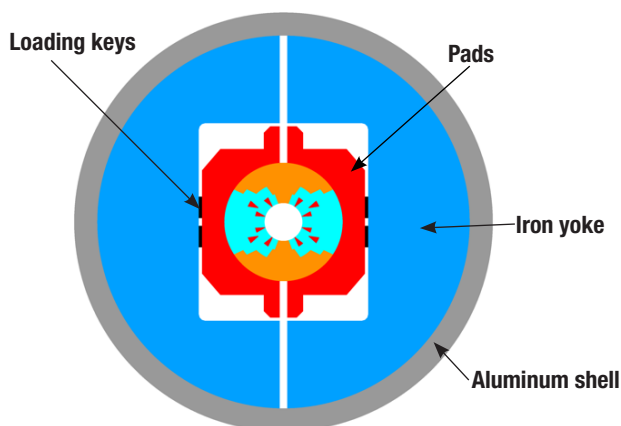

support structure customized for strain-sensitive superconductors such as Nb_3Sn has been developed and optimized [13,14]. A new cosine-theta design incorporating the latest superconductor and structure improvements should attain 16 T with a 50 mm aperture and will serve as a reference design for the program. This goal is supported by a 2013 DOE review of HEP, which stated in its report:

“Recent efforts toward high field magnets have not been as successful as expected. Despite a doubling of the critical current density in Nb_3Sn , recent test magnets with a gap have not improved upon the earlier D20 field results of about 14 T... Given the lack of progress in increasing the bore field, it may be worthwhile to consider designing, fabricating, and testing a cos-theta magnet like D20 but using the recent advances in 2D/3D design techniques and the best available Nb_3Sn strand to see if there are any fundamental limitations to the present approach.”

A technical baseline design based on an optimized cosine-theta geometry that addresses this comment has been developed utilizing existing expertise, tooling and infrastructure available at FNAL [15,16]. The proposed 4-layer, 60 mm aperture dipole will explore the target field and force range and serve as a technical and cost basis for comparison with new concepts. It also offers an opportunity for program integration, particularly in the area of support structure design, and for exploration of various support structures. This is the most cost effective way to get into a field range that would exceed the LBNL D20 dipole built almost 20 years ago. A successful series of magnets will provide a platform for performance improvement by integrating the outcomes of the Technology Development program; the integration will then be followed by value engineering studies. In

Figure 3. Canted-Cosine-Theta (CCT) concept.

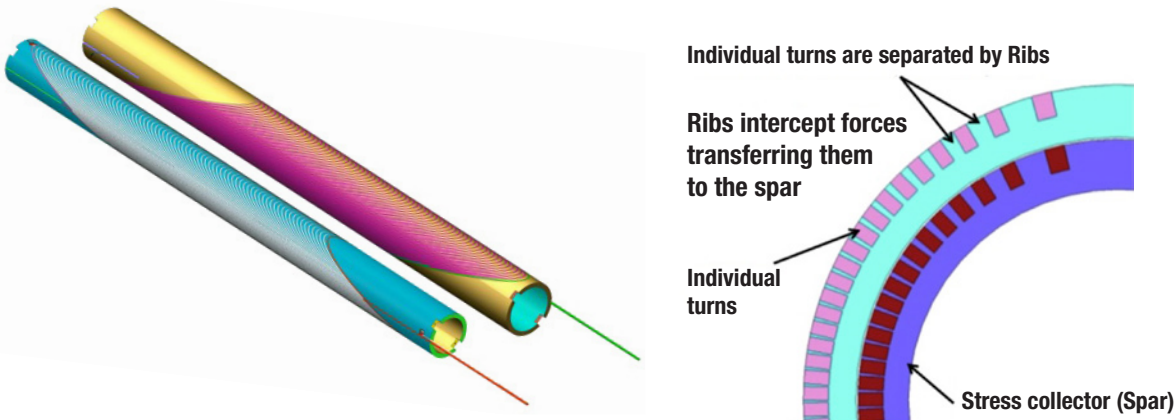

parallel, the program will develop a cos-theta design that explores the ultimate limit of Nb₃Sn in this geometry.

- **Explore innovative designs with stress management, initially with the Canted Cosine-Theta approach** (see Figure 3), that strive to address accumulation of Lorentz forces and resulting high mechanical stresses, and that have potential for reducing the cost per T-m. Both are dominant issues in high field magnets.

A critical aspect of the program is to aggressively investigate innovative new design concepts that may prove to have better performance at a lower cost per T-m. Initially, an alternative magnet design, the CCT concept, will be investigated for high-field accelerator magnets [17,18]. The main motivation is in the area of mechanical stresses: preliminary calculations show dramatic reduction in azimuthal stresses, effectively eliminating these stresses as limitations in the magnet design. If this proves to be the case, the concept will allow for conductor grading and for the implementation of HTS materials for very high-field CCT magnet designs. Since this design is quite different from previous geometries, the first phase will focus on a 2-layer design with a nominal bore field of 10 T and 90 mm aperture in order to understand performance drivers and establish

Figure 4. Overview of the Nb₃Sn milestone plan, highlighting the Cos(θ) reference magnet development (*top*) and the innovation route with CCT: ~10 T subscale magnet development (*middle*), followed by 16 T model magnets (*bottom*).

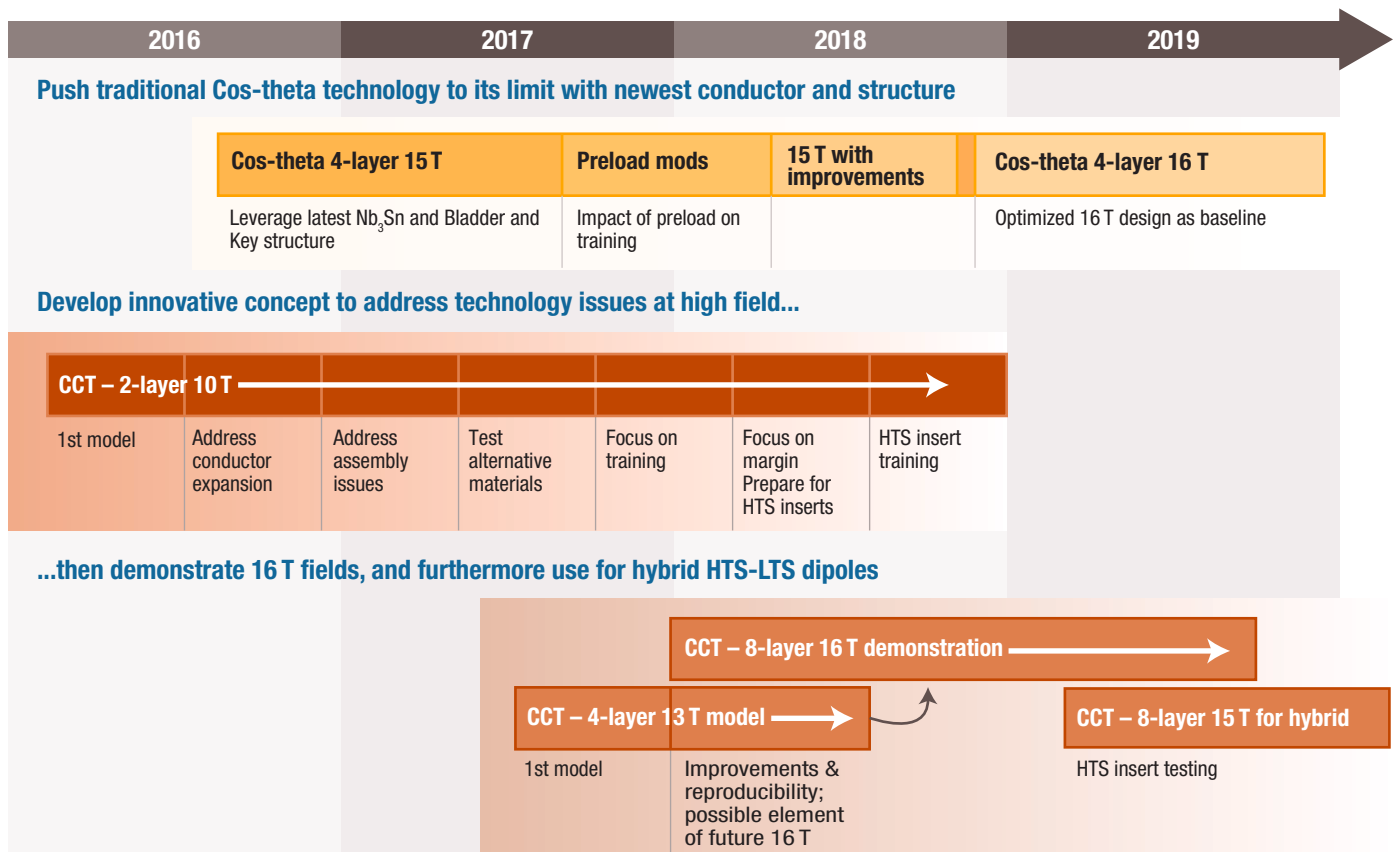
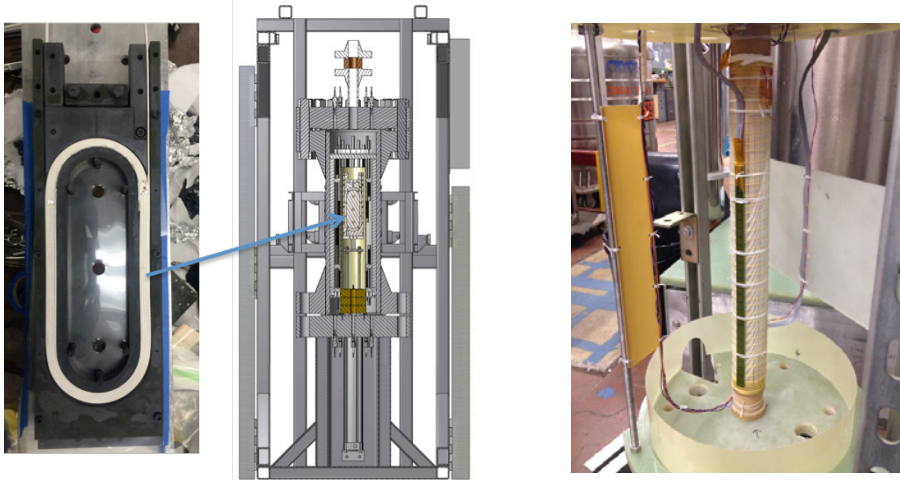

Figure 5. *Left:* LBNL Bi-2212 racetrack coils in Florida State University furnace. *Right:* Bi-2212 Canted-Cosine-Theta coil in test fixture.



fabrication techniques. Once deemed successful, the next steps would lead to an 8-layer, 16 T dipole with 90 mm aperture. The 90 mm bore size allows these magnets to potentially serve for testing of HTS inserts fairly early in the program.

When sufficient experience has been gained through this program and the parallel technology development component (see section 2.4), there will be a down-select or branch point to an alternative design path. A schematic of the Nb_3Sn magnet development path during FY17-19 is provided in Figure 4.

Directions and Deliverables

This part of the program will develop HTS insert magnets to achieve fields beyond those attainable with Nb_3Sn , and HTS stand-alone magnets for special applications. The HTS program is primarily focused on determining the feasibility of HTS materials for use in accelerator magnets, but will take a broad, generic approach to development of the technology. The overarching goal is to design and fabricate HTS accelerator magnets that generate record field while maintaining an ongoing vigorous science program, using a full suite of design, fabrication, test and instrumentation tools available from the participating institutions. We will study and develop both Bi-2212 and REBCO* technology, working with SBIR*/industry and DOE university programs.

The scope of work includes:

- **Bi-2212 sub-scale magnets** using racetrack and CCT configurations to demonstrate HTS dipole technology (see Figure 5).

The approach is to use the previously developed racetrack magnet R&D platform [19] and the new CCT geometry to explore technology limits to 5 T or greater in a dipole configuration for both stand-alone and high field inserts with bores greater than or equal to 50 mm and lengths ranging from 50 – 100 cm. The near term focus is on

2.3 High Field Magnet Development to Explore the Limits of HTS

* REBCO: Rare Earth-Barium-Copper Oxide superconductor
SBIR: Small Business Innovation Research

Figure 6. *Left:* YBCO (yttrium barium copper oxide) stacked tape test mandrel. *Right:* CORC conductor test mandrel.

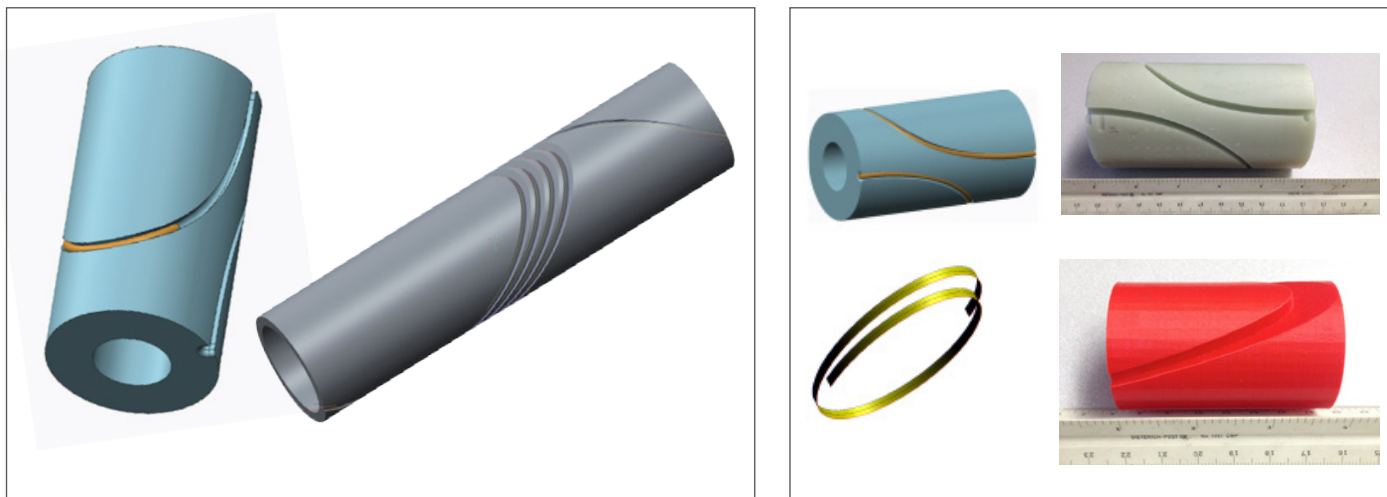

developing the basic magnet technology capable of leveraging recent gains in current density stemming from over-pressure processing [20]: this includes further development and optimization of insulation and structural materials compatible with the $\sim 900^\circ\text{C}$ O_2 environment, better understanding of the impact of conductor strain on transport current, and optimization of magnet design to eliminate conductor damage at field [21]. These efforts will be followed by detailed subscale magnet tests on quench detection and propagation, a critical issue with HTS magnets; the experiments will be performed in parallel with quench modeling, leading to the design and optimization of magnet protection schemes for Bi-2212 magnets.

- **REBCO-based dipole and quadrupole magnets** using racetrack and CCT coil configurations with the best available cable designs. Initial examples include stacked tapes and Conductor on Round Core (CORC[®]) [22] (see Figure 6).

The approach includes the design and test of CCT dipole magnets using CORC and stacked-tapes and quadrupole magnets made using racetrack coils. Near term plans include: systematic evaluation of the cable designs, including current redistribution in the cable during magnet ramping; development of coil fabrication processes including cable insulation, coil winding, and vacuum impregnation; study of quench behavior including normal zone growth, dynamic temperature rise, and resulting thermally induced strain; and analysis and measurement of magnetization and development of mitigation measures.

Figure 7. Overview of the HTS milestone plan, highlighting the Bi-2212 magnet development (*top*) and the REBCO magnet development (*bottom*).

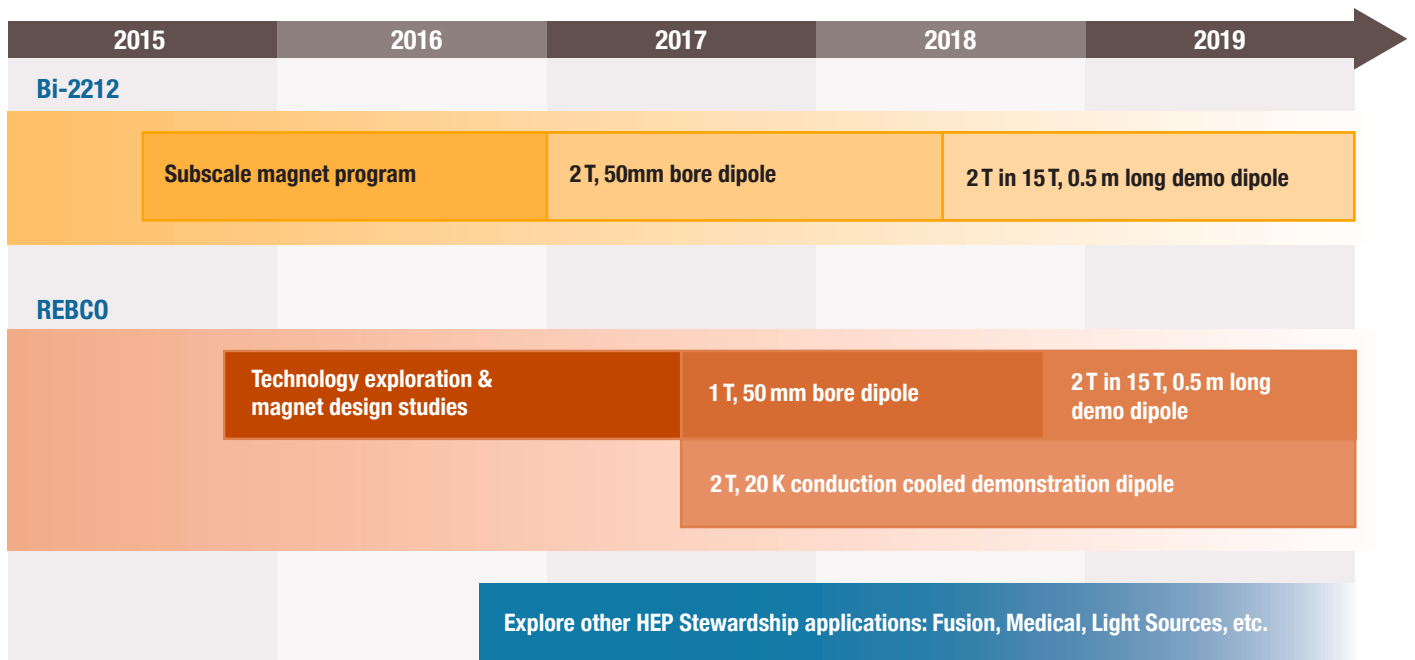

Progress on the activities generally described here will be monitored via well-defined milestones over the next two years to establish viability of these materials for a broad range of potential magnet applications.

For both HTS options we will leverage recent developments in sensitive quench detection schemes and fast extraction circuits based on IGBTs* to facilitate magnet protection schemes. From that basis, we will develop magnet protection models to design and optimize protection techniques for hybrid LTS-HTS magnets, i.e., HTS inserts in larger-bore LTS* dipoles. Note that the current LTS CCT dipole designs already incorporate 90 mm bores compatible with future HTS insert testing. A schematic of the HTS development path is provided in Figure 7.

Both of these programs will be used as technology development testbeds to guide US conductor development with leveraging from the SBIR and Conductor R&D programs.

HEP MDP goals for HTS magnet development will focus on unique capabilities, goals and driving questions relevant to HEP. However, we note that there are areas of strong overlap with other DOE Office of Science programs where development of enabling technology could be leveraged through collaboration and coordination with other research efforts, particularly university programs. One example would be high current (10 kA-class) cables that are of mutual interest for HEP and Fusion applications.

* IGBT: insulated-gate bipolar transistor
LTS: low-temperature superconductor

2.4 Magnet Science: Developing Underpinning Technologies

Breakthroughs in magnet performance, particularly in training and operating margin requirements, will require further understanding and control of the underlying physics mechanisms. Energy deposition that initiates quenches, resulting in training or sub-par magnet performance, can emanate from a variety of sources, resulting in a “disturbance spectrum.” Well-defined experiments designed to identify and “fingerprint” the sources, and to evaluate technology alternatives that minimize the amplitude of such disturbances, are critical to addressing the first goal of the program. This magnet science component of the program leverages developments in modeling, materials, and diagnostics that are critical to advancing magnet technology and serve as a core element of the MDP.

Directions and Deliverables

The main program elements described above will be supported through a broad technology development program designed to focus on specific topics related to the Driving Questions (see Table 1). This activity is a combination of science-driven modeling and simulation studies benchmarked against dedicated, focused tests with limited scope that are relatively low cost with fast turnaround, where “fast” is defined as less than 3 months. Essentially the activity is a reformulation of the successful sub-scale program where speed, simplicity and low cost are the primary criteria. The scope of a given study topic would easily fit the available infrastructure and capabilities of a small university group or industrial partnership, thereby providing opportunities for a larger, more cost-effective program. The program will also provide guidance for SBIR proposals.

Technology development and training studies using subscale and model magnets.

Subscale models designed to provide rapid, cost-effective turnaround will support Nb₃Sn and HTS magnet developments and address the driving questions. These subscale models serve as the initial magnet testbeds for exploitation of improvements in materials and diagnostic techniques [23].

Develop new capabilities, e.g., insert-testing infrastructure and techniques, expanded facility resources and availability.

The Program will integrate test groups at participating institutions for efficiency, increasing intellectual critical mass, improving capabilities and providing adequate accessibility. Integration of the US magnet and materials programs will result in more effective use of existing facilities but there will be a need for upgrades to accommodate the requirements for the next generation of high performance magnets. New capabilities for testing novel magnet configurations are essential to provide insight into magnet behavior and feedback for magnet improvements. Subscale and model magnets need to be tested with a spectrum of diagnostics and flexible test schemes, and these capabilities must be available for rapid turnaround. Further into the program, facilities need to be upgraded to allow testing of hybrid (LTS+HTS) magnet systems.

Investigate new materials (insulation, impregnation and structural materials, etc).

The primary sources of magnet training emanate from materials and material interfaces, in particular the insulation, impregnation, and neighboring structural materials. There is ample evidence that training behavior derived from these sources can be affected by the support structure design and pre-stress configuration. This is a ripe area to explore for significant improvements in magnet performance: examples include improvements in insulation materials (e.g., quartz or ceramic fibers vs. the traditional S-or E-glass fibers); new techniques that can eliminate insulation sizing completely, or clean the sizing from wound magnets; surface treatments that can significantly improve epoxy adhesion; improvements in the epoxies themselves to enhance toughness; and superconductor and structural material chemical compatibility. These areas can be explored with low-cost, dedicated laboratory experiments prior to testing in subscale magnets, and are ideal for collaboration with universities and industry (e.g., SBIR).

Further development of analysis tools, quench detection and protection techniques, and diagnostics.

Analysis tools have progressed significantly and when coupled with well-instrumented subscale and model magnet tests can provide essential understanding of magnet behavior and hence directly address the driving questions for the program. New diagnostics can be designed to provide critical feedback in areas where analysis shows high magnet performance sensitivity. Furthermore, the potential exists to “fingerprint” the disturbance spectrum sources to provide direct feedback on the mechanism of training.

Full 3D magnetic and mechanical modeling of complete magnet systems can now be performed, including all interface considerations; concepts can be iterated and optimized, i.e., virtually prototyped, prior to freezing a design and procuring hardware. First implementation of FEA* software on parallel clusters has shown order-of-magnitude reduction in simulation time; we envision similar enhancements over the next couple of years, which will enable new optimization approaches to be applied to magnet design. Similarly, magnet protection models can address a breadth of spatial and temporal scales, from quench initiation and early propagation to full circuit modeling including coupled magnet, power supply and dump resistor behavior. Development of reliable stress/strain gauges with large temperature and field ranges are important for understanding magnet behavior and benchmarking magnet design and simulation codes. Sub-scale magnets will provide a cost-effective method for studying methods of correcting and compensating coil magnetization effects.

Design comparison and cost analysis to guide program direction.

Historical preferences for specific magnet design concepts are common in the high-field magnet community. Designs need to be subjected to objective,

*FEA: finite-element analysis

2.5 Superconducting Materials – Conductor Procurement and R&D (CPRD)

quantitative scrutiny to identify relative advantages and disadvantages and to guide the program towards the most effective and efficient solutions.

A timeline for major milestones for the technology development program is provided in Figure 8.

Conductor development is a critical component of the program vital to Magnet Program needs. The role of CPRD is twofold: 1) procurement of “workhorse” conductors to support magnet R&D and 2) further industrial development of more advanced conductors relevant to the MDP. Key elements of CPRD include definition of achievable goals and milestones for:

- Determining the performance limits of Nb₃Sn and HTS conductors.
- Understanding uniformity and reliability, especially of HTS conductors.
- Understanding of future conductor scalability and cost.
- Evaluating factors critical for eventual worldwide capacity ramp-up for future projects so as to minimize start-up costs and allow more competition.

Directions and Deliverables

Making 16 T dipoles is a challenge to both magnet and conductor technology. In the immediate future it will drive CPRD to considering Nb₃Sn conductors beyond the limits of present production, which are approximately 1500 A/mm² at 15 T and 4.2 K [24, 25]. New R&D targets for critical current density of 1500 and 2200 A/mm² at 16 T at 4.2 and 1.9 K will require either pushing to their limits our understanding of how to better manufacture and optimize the reaction of present RRP* and PIT* Nb₃Sn or introducing additional strong pinning (e.g., ZrO₂ artificial pinning center ideas) into such conductors. At present, the capability for further development of Nb₃Sn is unclear and most effort is within the university and SBIR programs. Depending on progress there, such ideas could be brought into CPRD as they mature and show capability of being made into suitable magnet-length conductors. Especially as the magnet R&D program better develops an understanding of the margins required for avoiding or minimizing magnet training, more targeted programs on Bi-2212 and REBCO strand and cable development will be developed. At present the focus is on first defining and optimizing strand performance and then demonstration of 10 kA class cables that can be used for HTS dipole insert magnets.

The **research and development** purpose of CPRD is to anticipate future magnet development needs including both LTS and HTS wires and cables. *Conductor development leads magnet development by 5 years or more* and CPRD must also envision conductor needs 10 to 20 years out, which could be conductors for magnets beyond the capability of Nb₃Sn, or for magnets that do not require liquid helium, since helium is likely to become increasingly more expensive.

* RRP: Restack Rod Process
PIT: Powder-In-Tube

Figure 8. Overview of the technology development milestone plan, which feeds the Nb₃Sn and HTS magnet program elements. The primary elements of the technology development program are facility improvements, diagnostics, materials, and advanced modeling and analysis.

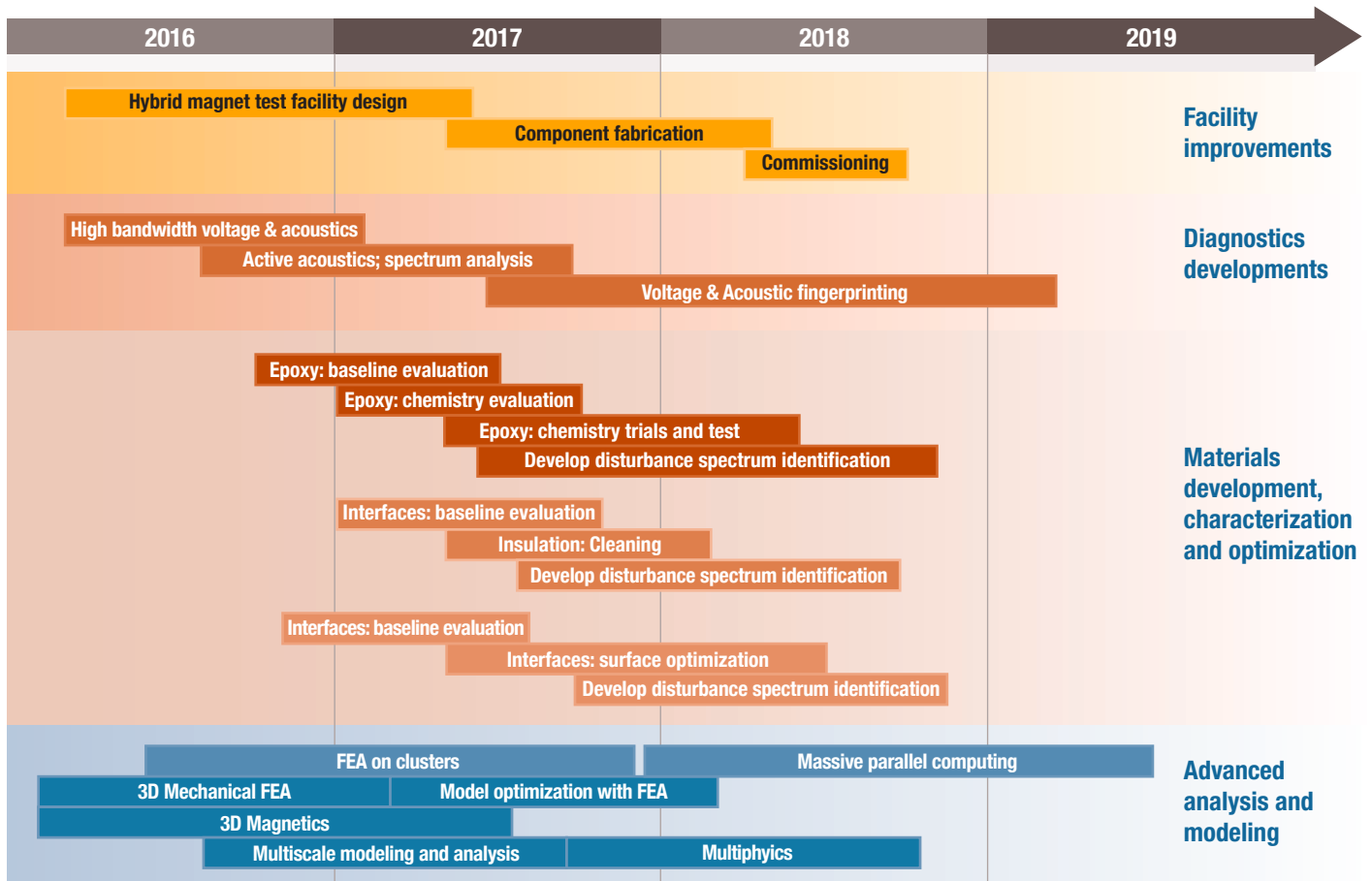

Research emphasizes the present industrially produced cuprate high temperature superconductors Bi-2212 and REBCO that can be cabled. (Bi-2212 stands for the silver-sheathed round wire superconductor $\text{Bi}_2\text{Sr}_2\text{CaCu}_2\text{O}_{8+x}$ and REBCO describes thin film superconductors in tape form based on the formula $(\text{RE})\text{Ba}_2\text{Cu}_3\text{O}_{7-\delta}$ where RE represents the element Y or other Rare Earth.) CPRD will strive to maintain a carefully balanced portfolio, while also emphasizing conductor manufacturing. Importantly, CPRD is intended to support conductor R&D when other sources of research support, such as SBIR grants, cannot be used. This permits the suppliers with the highest level of manufacturing capability to request and possibly receive R&D support.

The **procurement** responsibility of CPRD is to supply the MDP with production-quality conductors for the cables required for experimental magnets. Such cables must be free from artifacts that would adversely affect magnet behavior so as to allow MDP research to isolate issues associated purely with the magnet technology.

3.

Schedule and Milestones

3.1 Schedule and Milestones

Schedule, milestones and the relationship of program thrusts to the **Driving Questions** are shown in Figure 9, are based on assumed funding profile. Since the out-year program depends strongly on outcomes of the first three years, notional milestones are shown only through FY19.

		FY17				FY18	
		Q1	Q2	Q3	Q4	Q1	Q2
Nb₃Sn							
Canted-Cosine Theta Concept							
Test & Decision Milestones	2-layer CCT 10 T	2-layer CCT 10 T			4-layer CCT 13 T	Engineering design of 16 T dipole model suitable for HE-LHC or FCC	4-layer CCT 13 T
Primary Focus/ Significance	Develop fabrication techniques, impregnation materials. Establish a platform for increasing number of layers and field. Informs Driving Questions 1, 2, 3, 4, 9. Understand the impact of lower stress on magnet training. Overall contribution to experience base, feedback for modeling and simulation tool development, diagnostics development.	Further development of fabrication techniques. Informs Driving Questions 1, 2, 3, 4, 9. Understand the impact of lower stress on magnet training.			Ramp up field in CCT configuration. Investigate multi-layer assembly and mechanics. Informs Driving Questions 1, 2, 3, 4, 9. Understand the impact of lower stress on magnet training. Multi-layer assembly methods.		Assuming success of previous 4-layer magnet, a second 4-layer magnet that can be combined into an 8-layer magnet to reach 16 T. Informs Driving Questions 1, 2, 3, 4, 9. Multi-layer assembly methods.
Cosine-Theta Baseline							
Test & Decision Milestones	Comparison study of alternative mechanical structures. Informs Driving Questions 3, 6, 9.	Mechanical model assembly, instrumentation and test is complete. Informs Driving Questions 3, 9.	Review and select the mechanical structure for the first 15 T 4-layer Cos-theta dipole.		4-layer Cosine-theta 15 T	Retest of previous 4-layer Cosine-theta 15 T with preload modifications	
Primary Focus/ Significance					Establish baseline with best understood coil geometry. Investigate stress limits in a coil design without resorting to stress management. Informs Driving Questions 1, 2, 4, 5, 7. Overall contribution to experience base, feedback for modeling and simulation tool development, diagnostics development.	Important for establishing warm prestress limits and impact on training. Informs Driving Questions 1, 2, 4, 5, 7.	

Figure 9. MDP top-level schedule and milestones for FY17 – FY19.

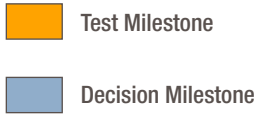

		FY19				
Q3	Q4	Q1	Q2	Q3	Q4	
						POSSIBLE BRANCH POINTS AND/OR DOWNSelect
8-layer CCT 16 T			8-layer CCT 16 T	2-layer CCT 10 T		Evaluate feasibility and next steps. Consider possible alternate routes based on previous design studies and accumulated experience.
Combine the two 4-layer magnets into an 8-layer dipole designed to reach 16 T. Major program milestone. Informs Driving Questions 1, 2, 3, 4, 5, 7, 9. Multi-layer assembly methods.			Incorporate improvements and lessons learned from previous 8-layer dipole. Informs Driving Questions 1, 2, 3, 4, 5, 7, 9.	Assembly using laminations to inform Driving Question 9. Likely to include improvements derived from Technology Development program and previous magnet tests.		
	4-layer Cosine-theta 15 T	Engineering design of 16 T dipole model suitable for HE-LHC or FCC		4-layer Cosine-theta 16 T		Evaluate feasibility and next steps. Consider possible alternate routes based on previous design studies and accumulated experience.
	Incorporate improvements and lessons learned from previous 4-layer dipole. Informs Driving Questions 1, 2, 4, 5, 7.	Structure analysis and selection for 50 mm aperture dipole model is complete.		Push to the field limit in optimized 16 T design. Start to incorporate cost reduction strategies. Informs Driving Questions 1, 2, 3, 4, 5, 6, 7, 9.		

FY17				FY18	
Q1	Q2	Q3	Q4	Q1	Q2

High Temperature Superconductor Magnets

Bi-2212

Test & Decision Milestones	Coils using CCT and Racetrack Geometries	Coils using CCT and Racetrack Geometries	Coils using CCT and Racetrack Geometries	Coils using CCT and Racetrack Geometries	Coils using CCT and Racetrack Geometries	5 T, 50 mm Bi-2212 Dipole
Primary Focus/ Significance	Develop basic technology for Bi-2212. Optimized reaction for coils, conductor improvements, insulation, stress limits, magnetization effects. Informs Driving Questions 2, 3, 4, 7, 8, 9, 10.				Develop basic technology for Bi-2212. Optimized reaction for coils, conductor improvements, insulation, stress limits, magnetization effects. Informs Driving Questions 3, 4, 5, 6, 8, 9, 10.	Significant milestone in demonstration of feasibility. Could lead to broader applications

REBCO

Test & Decision Milestones	Conductor-On-Round-Core (CC) Tests and 35-turn model coil using Stacked Tapes	Continued tests of high current cable concepts in CCT and racetrack geometries	Test of REBCO cable concepts based on small bore insert geometries	Test of a 1 T, 50 mm bore dipole	Test of 2 T, 20 K, conduction cooled dipole demo	
Primary Focus/ Significance	Determine application parameters for new cable: bending radius, joints, etc. Informs Driving Questions 4, 5, 6, 8, 9, 10. Important demonstration of a new cable concept that would have many applications beyond HEP accelerator magnets.	Continued design and parametric tests. Fundamental elements of high current cable design and mechanical limits of REBCO. Informs Driving Questions 4, 5, 6, 8, 9, 10.	Informs Driving Questions 3, 4, 5, 6, 7, 8, 9, 10.	Evaluation and possible mitigation of magnetization effects. Informs Driving Questions 3, 4, 5, 6, 7, 8, 9, 10.	Evaluation and possible mitigation of magnetization effects. Informs Driving Questions 3, 4, 5, 6, 7, 8, 9, 10.	
Basis for development of applications outside HEP: BES, NP, medical. Will help generate industry involvement, increase competition between conductor manufacturers with potential to reduce conductor cost.						

Technology Development Program

Test & Decision Milestones	Continuous program to develop underlying technology. Focus on specific topics related to performance and cost reduction. Examples are reaction test to evaluate compatability of cable and mandrels, fabrication techniques, insulation, epoxies, quench detection and protection, diagnostics development, design studies/comparisons. Improvements will be integrated into magnets as they become available.	Strive for at least 1 test per quarter.		
----------------------------	--	--	--	--

Conductor Development

Ongoing program to improve conductor driven by magnet needs. <ul style="list-style-type: none"> • Performance • Uniformity (reliability) • Scalability and cost • Simplicity of manufacture 	Nb₃Sn — a) wire R&D to improve high-field J_c , control magnetization and stability; b) cable R&D on cable size and performance optimization (larger strand size and number of strands, compaction and I_c and RRR degradation, mechanical stability and windability, eddy current effects, cable splicing, etc.). Informs Driving Questions 6, 10.
---	---

		FY19			
Q3	Q4	Q1	Q2	Q3	Q4
					POSSIBLE BRANCH POINTS AND/OR DOWNSELECT
			<p>2 T, 0.5 m HTS Dipole in 15 T Dipole Background Field</p> <p>Understand aspects of operating Bi-2212 inserts. Evaluation and possible mitigation of magnetization effects. Informs Driving Questions 3, 4, 5, 6, 7, 8, 9, 10.</p>		Evaluate feasibility and next steps. Consider possible alternate routes based on previous design studies and accumulated experience.
<p>2 T HTS dipole in high field dipole background field</p> <p>Understand aspects of operating HTS inserts. Evaluation and possible mitigation of magnetization effects. Informs Driving Questions 1, 2, 3, 4, 5, 7, 8, 9, 10.</p>		<p>Evaluate feasibility and next steps. Consider possible alternate routes based on previous design studies and accumulated experience.</p>			
<p>Bi-2212 — Develop U.S. powder suppliers, increase superconductor in the cross-section, explore silver alloys for higher strength. Informs Driving Questions 2, 5, 6, 7, 8, 9, 10.</p>			<p>YBCO — Support work from the magnet application side on development of high current cables, improve performance at 4.2 K and reduce magnetization effects. Informs Driving Questions 2, 5, 6, 7, 8, 9, 10.</p>		

4.

The MDP Management Plan

4.1 The MDP Leadership and Management Structure

In order to carry out a program that addresses the technical challenges of exploring options for far-future frontier colliders the MDP will:

- Integrate the efforts of U.S. laboratories, universities and industry to maximize effectiveness in achieving Program goals.
- Manage the Program with well-defined deliverables and clear reporting lines integrated with relevant R&D efforts of international partners.
- Manage the Program with clear milestones and budget profile to carry out the approved program scope and goals. LBNL serves as the host institution for the MDP organization. The Program Director and Program Management Office are based at LBNL.

Responsibility Matrix

The early emphasis of the Program is to integrate the participating institutions via working groups and collaborative tasks in a way that makes the most effective use of the overall available resources. The goal is that each partner should own a stake in the primary Program activities via coordinated activities and responsibilities. Location and management of activities will be based on interests, capabilities aligned with Program goals, and available facilities of the participating institutions. Participation in the near term is limited by the current DOE funding level and distribution.

The management structure outlined below provides a system of checks and balances to allow conflict resolution to occur, i.e., technical issues can be resolved with the aid of the Technical Advisory Committee, and institutional issues can be resolved via the Program Oversight Board.

The Anticipated MDP Funding

The program outlined in this document, guided by the Driving Questions, is designed to answer those questions and achieve the stated goals within a timeframe that will have impact and relevance to the worldwide effort to develop technology for a future high-energy pp collider as well as new, broader applications associated with this development. Satisfying the Program Goals and finding answers to the Driving Questions will require the execution and integration of many elements, none of which alone may satisfy all the requirements. These elements are expressed by the directions and deliverables described in Section 2.

To ensure that this comprehensive program is timely, relevant and internationally competitive, a funding increase above the FY16 level to approximately \$14M per year is needed. This funding will support both materials R&D and magnet development. Lower funding levels would significantly impact our ability to deliver the scope of work described in this document.

Figure 10. MDP top-level organization.

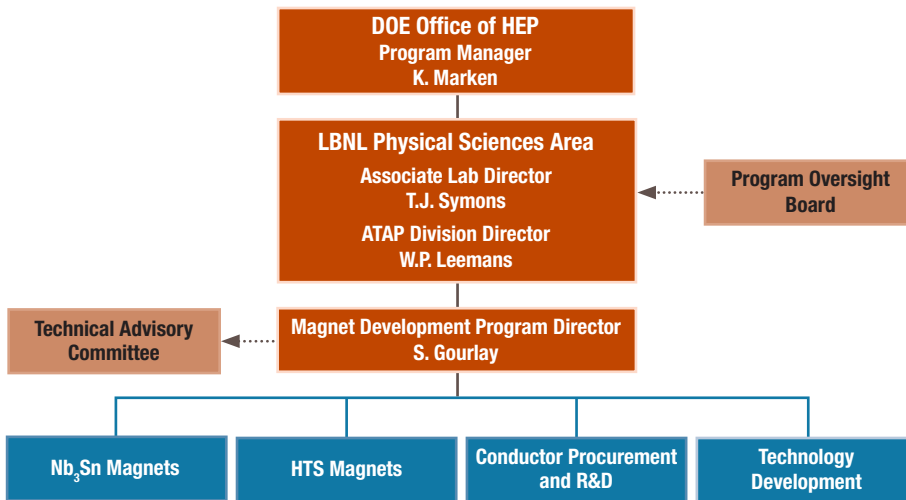

Management Structure

The top-level MDP organizational structure is shown in Figure 10. The DOE Office of High Energy Physics has designated a Program Manager to oversee MDP from within the agency. At LBNL, a Program Director (L1 Manager) has been appointed. An MDP Deputy may be appointed by the Program Director to support activities in the Management Office.

A Program Oversight Board and advisory committee are incorporated into the MDP organizational structure.

Program Oversight Board

The MDP Program Oversight Board (POB) provides a coordinated communication channel between the LBNL Directorate and the directorates of the U.S. DOE laboratories in MDP. It advises the Associate Laboratory Director for Physical Sciences. The POB meets at least once per year to discuss issues of joint policy or strategy, or MDP access and/or use of specific Laboratory infrastructure. Most meetings are by phone, email or video conference.

MDP Technical Advisory Committee

The MDP Technical Advisory Committee (TAC) is composed of a combination of technical experts appointed by the Program Director, and institutional representatives appointed in consultation with participating laboratory management. The committee chair is appointed by the Program Director. The TAC is convened by the Program Director on an as-needed basis to provide advice on technical issues that may arise.

Technical Reviews and Workshops – Community Input and Expansion of Participation

A Technical Workshop will be organized at least once per year for L1 and PI update reports on current activities and to provide a forum for community input

on the MDP scope and direction. This is the primary mechanism for augmenting or modifying the program scope and expanding participation in the program.

Host Lab Authorities and Responsibilities

The primary role of LBNL, as Host Laboratory, is to provide institutional commitment to the success of the program. In fulfilling this role, LBNL provides both support of program management and also institutional oversight. Specific responsibilities include:

- Chairing the Program Oversight Board.
- Provision of administrative support for the Program Director, including assistance in financial reporting.
- Advising the DOE Office of High Energy Physics on programmatic and policy issues arising within the Program.

MDP Director Function and Responsibilities

The MDP Director is responsible for:

- Overall coordination of the MDP. This includes establishing technical policy, setting MDP priorities, and allocating funds to all institutions receiving support from the U.S. Department of Energy through the MDP.
- Implementing a program management plan that:
 - Defines the management and reporting structure;
 - Provides clearly defined responsibilities within that structure;
 - Establish and maintain close interactions with host laboratory management (Physical Sciences Associate Laboratory Director and ATAP Division Director) and with the stakeholders of the MDP, including: the funding agency; the laboratories, universities and other institutional participants.
- Maintaining a multi-year program execution plan for MDP activities that:
 - Defines the major research goals and objectives;
 - Clearly identifies the required personnel resources and funding profile;
 - Utilizes suitable program management tools in order to execute an R&D program of this size;
 - Ensures timely design choices and selections between competing technologies;
 - Provides a clear set of milestones and deliverables against which progress can be evaluated;
 - Provides technical, cost and schedule reports on a quarterly basis to LBNL management and the DOE-HEP.

References

- [1] Future Circular Collider Study Kickoff Meeting (University of Geneva, February 12-14, 2014); <http://indico.cern.ch/event/282344/timetable/#20140212>
- [2] Yifang Wang, “Introduction to CEPC/SppC”: <http://indico.cern.ch/event/282344/session/1/contribution/65/material/slides/1.pdf>
- [3] *Building for Discovery: Strategic Plan for U.S. Particle Physics in the Global Context*, the Particle Physics Project Prioritization Panel (P5) Report; http://science.energy.gov/~media/hep/hepap/pdf/May%202014/FINAL_P5_Report_053014.pdf
- [4] “Accelerating Discovery: A Strategic Plan for Accelerator R&D in the U.S.” (HEPAP Accelerator R&D Subpanel Report, April 2015); <http://science.energy.gov/hep/hepap/reports/>
- [5] W. Wan, L. Brouwer, S. Caspi, S.O. Prestemon, A. Gerbershagen, J.M. Schippers, and D. Robin, “Alternating-Gradient Canted Cosine Theta Superconducting Magnets For Future Compact Proton Gantries,” *Physical Review Special Topics — Accelerators and Beams* **18**, 10 (October 2015), p. 103501; <http://dx.doi.org/10.1103/PhysRevSTAB.18.103501>
- [6] H. Felice et al., “Design of a Superconducting 28 GHz Ion Source Magnet for FRIB Using a Shell-Based Support Structure,” *IEEE Transactions on Applied Superconductivity* **25**, 3 (2015), pp. 1–5; <http://dx.doi.org/10.1109/TASC.2014.2377730>
- [7] C. Lyneis, D. Leitner, D. S. Todd, G. Sabbi, S. Prestemon, S. Caspi and P. Ferracin, “Fourth Generation Electron Cyclotron Resonance Ion Sources (invited),” *Review of Scientific Instruments* **79**, 2 (2008); <http://dx.doi.org/10.1063/1.2816793>
- [8] D.G. Whyte, J. Minervini, B. LaBombard, E. Marmor, L. Bromberg, and M. Greenwald, “Smaller & Sooner: Exploiting High Magnetic Fields from New Superconductors for a More Attractive Fusion Energy Development Path,” *Journal of Fusion Energy* **35**, 1 (22 January 2016), pp. 41–53; <http://dx.doi.org/10.1007/s10894-015-0050-1>
- [9] *High Magnetic Field Science and Its Application in the United States: Current Status and Future Directions* (National Academies Press, 2013); <http://www.nap.edu/catalog/18355/high-magnetic-field-science-and-its-application-in-the-united-states>
- [10] G. Apollinari, S. Prestemon and A.V. Zlobin, “Progress with High-Field Superconducting Magnets for High-Energy Colliders,” *Annual Review of Nuclear and Particle Science* **65** (October 2015), pp. 355–377; <http://www.annualreviews.org/doi/abs/10.1146/annurev-nucl-102014-022128>
- [11] Luca Bottura, Stephen A. Gourlay, Akira Yamamoto, and Alexander V. Zobin, “Superconducting Magnets for Particle Accelerators (invited),” *IEEE Transactions on Nuclear Science* **63**, 2 (April 2016), pp. 751–776; <http://dx.doi.org/10.1109/TNS.2015.2485159>

- [12] D. Dell’Orco, R. Scanlan, and C.E. Taylor, “Design of the Nb₃Sn Dipole D20,” IEEE Transactions on Applied Superconductivity **3**, 1 (February 1993), pp. 82-86; <http://ieeexplore.ieee.org/stamp/stamp.jsp?arnumber=233677>
- [13] R.R. Hafalia, P.A. Bish, S. Caspi, D.R. Dietderich, S.A. Gourlay, R. Hannaford, A.F. Lietzke, N. Liggins, A.D. McInturff, G.L. Sabbi, R.M. Scanlan, J. O’Neill, and J.H. Swanson, “A New Support Structure for High Field Magnets,” in Proceedings of MT-17, the 17th International Conference on Magnet Technology (Geneva, Switzerland, September 24 – 28, 2001), IEEE Transactions on Applied Superconductivity **12**, 1 (March 2002), pp. 47-50; <http://ieeexplore.ieee.org/stamp/stamp.jsp?arnumber=1018349>
- [14] A.F. Lietzke, S. Bartlett, P.A. Bish, S. Caspi, L. Chiesa, D.R. Dietderich, P. Ferracin, M. Goli, S.A. Gourlay, R.R. Hafalia, C.R. Hannaford, H. Higley, N.L. Liggins, S. Mattafirri, A. McInturff, M. Nyman, G. Sabbi, R.M. Scanlan, J. Swanson, “Test Results for HD-1, a 16 Tesla Nb₃Sn Dipole Magnet,” IEEE Transactions on Applied Superconductivity **14**, 2 (June 2004), pp. 345-348; <http://dx.doi.org/10.1109/TASC.2004.829122>
- [15] A.V. Zlobin, N. Andreev, E. Barzi, V.V. Kashikhin, and I. Novitski, “Design Concept and Parameters of a 15 T Nb₃Sn Dipole Demonstrator for a 100 TeV Hadron Collider,” in Proceedings of the 2015 International Particle Accelerator Conference; <http://accelconf.web.cern.ch/AccelConf/IPAC2015/papers/wepty041.pdf>
- [16] I. Novitski, N. Andreev, E. Barzi, J. Carmichael, V. V. Kashikhin, D. Turrioni, M. Yu, and A. V. Zlobin, “Development of a 15 T Nb₃Sn Accelerator Dipole Demonstrator at Fermilab,” IEEE Transactions on Applied Superconductivity **26**, 3 (June 2016), p. 4003006; <http://dx.doi.org/10.1109/TASC.2016.2517024>
- [17] L. Brouwer, D. Arbalaez, S. Caspi, H. Felice, S. Prestemon, and E. Rochepault, “Structural Design and Analysis of Canted “Cosine Theta” Dipoles,” in Proceedings of MT-23, the 23rd International Conference on Magnet Technology (Boston, Massachusetts, US, 14-19 July 2013), IEEE Transactions on Applied Superconductivity **24**, 3 (June 2014), p. 6620990; <http://dx.doi.org/10.1109/TASC.2013.2284425>
- [18] S. Caspi, F. Borgnolutti, L. Brouwer, D. Cheng, D.R. Dietderich, H. Felice, A. Godeke, R. Hafalia, M. Martchevskii, S. Prestemon, E. Rochepault, C. Swenson, and X. Wang, “Canted-Cosine – Theta Magnet (CCT) – A Concept for High Field Accelerator Magnets,” in Proceedings of MT-23, the 23rd International Conference on Magnet Technology (Boston, Massachusetts, US, 14-19 July 2013), IEEE Transactions on Applied Superconductivity **24**, 3 (June 2014), p. 6621012; <http://dx.doi.org/10.1109/TASC.2013.2284722>

- [19] A. Godeke, D.W. Cheng, D.R. Dietderich, C.R. Hannaford, S.O. Prestemon, G. Sabbi, X.R. Wang, Y. Hikichi, J. Nishioka, and T. Hasegawa, "Progress in Wind-and-React Bi-2212 Accelerator Magnet Technology," *IEEE Transactions on Applied Superconductivity* **19**, 3 (2009), pp. 2228–2231; <http://dx.doi.org/10.1109/TASC.2009.2018070>
- [20] D.C. Larbalestier, J. Jiang, U. P. Trociewitz, F. Kametani, C. Scheuerlein, M. Dalban-Canassy, M. Matras, P. Chen, N.C. Craig, P. J. Lee, and E. E. Hellstrom, "Isotropic Round-Wire Multifilament Cuprate Super-Conductor for Generation of Magnetic Fields Above 30 T," *Nature Materials* **13**, 4 (9 March 2014), pp. 375–381; <http://www.nature.com/doi/10.1038/nmat3887>
- [21] L. Ye, P. Li, T. Shen, J. Schwartz, "Quench Degradation Limit of Multifilamentary Ag/ Bi₂Sr₂CaCu₂O_x Round Wires," *Superconductor Science and Technology* **29**, 3 (2 February 2016) 035010; <http://iopscience.iop.org/0953-2048/29/3/035010>
- [22] D.C. van der Laan, "YBa₂Cu₃O_{7-δ} Coated Conductor Cabling for Low Ac-Loss and High-Field Magnet Applications," *Superconductor Science and Technology* **22**, 6 (28 April 2009); <http://iopscience.iop.org/0953-2048/22/6/065013>
- [23] S. Caspi, L. Chiesa, M. Coccoli, D.R. Dietderich, S.A. Gourlay, R. Hafalia, A.F. Lietzke, J.W. O'Neill, G. Sabbi, R.M. Scanlan, "An Approach for Faster High Field Magnet Technology Development," *IEEE Transactions on Applied Superconductivity* **13**, 2 (15 July 2003), pp. 1258–1261; <http://dx.doi.org/10.1109/TASC.2003.812632>
- [24] E. Barzi, A.V. Zlobin, "Research and Development of Nb₃Sn Wires and Cables for High-Field Accelerator Magnets," *IEEE Transactions on Nuclear Science* **63**, 2 (April 2016), pp. 783–803; <http://dx.doi.org/10.1109/TNS.2015.2500440>
- [25] D.R. Dietderich and A. Godeke, "Nb₃Sn Research and Development in the USA — Wires and Cables", *Cryogenics* **48**, 7 (2008), p. 331; <http://dx.doi.org/10.1016/j.cryogenics.2008.05.004>

Appendices

Appendix A: Motivation for the MDP

Motivation for the Creation of the MDP

1. MDP Will Advance High Energy Physics

U.S. national laboratories, industries and university programs, supported by DOE-OHEP, provided critical contributions to the advancement of superconducting accelerator magnet technologies during the past four decades. The impressive achievements of U.S. accelerator magnet R&D include world records in field strength and field gradient of magnets, successful technology industrialization and application in practical accelerators, and growth of the world's largest superconductor industry in the USA. Superconducting Nb-Ti magnets are the essential components of the Tevatron, HERA, RHIC, and most recently the LHC. The development of Nb₃Sn accelerator magnets by the General Accelerator R&D (GARD) programs, and the outstanding success of the LHC Accelerator Research Program (LARP) in moving that technology to practical use, is the most recent example of U.S. contributions to the worldwide pursuit of high energy physics.

In the words of the P5 report, "The U.S. is the world leader in R&D on high-field superconducting magnet technology, which will be a critical enabling technology for such a collider." We recognize that others are making significant investments in magnet R&D. The U.S. will need to generate a comparable effort to maintain a technological lead and be in a position to make a critical contribution to a future facility.

2. MDP Will Advance and Maintain U.S. Leadership in High Field Magnets

Until recently, U.S. leadership in high field accelerator magnet technology has remained largely uncontested. But now, new programs at CERN and in the EU, Japan and China are rapidly rising to challenge U.S. dominance in this technology. In fact, given the recent progress at CERN it is possible that the U.S. could lose the leadership position in high field accelerator magnet development unless considerable action is taken.

While we recognize that achieving the ambitious goals for a future high-energy proton-proton collider will require a coordinated international effort we also want to be in a position to make a major intellectual contribution in one of the key enabling technologies required to make such a machine a reality.

The U.S. magnet R&D program, outlined in this document, is based on the strategy outlined by P5 and the recommendations of the Accelerator R&D Subpanel in a report released in April 2015. The overall theme of the recommendations is to significantly improve the cost-performance of high field magnets for a future high-energy proton-proton collider. The Subpanel recommendations are listed in Appendix B. The internally integrated program will be executed in close coordination with other international magnet R&D efforts as well as with the US and global design studies. It is the vehicle by which the U.S. will maintain world leadership in

high field accelerator magnets. The outcome of this program will have an implicit impact on general magnet technology development for applications outside of HEP as well.

3. MDP Will Develop Magnet Technology Benefiting the DOE Office of Science — A Bridge to Expanded HEP Stewardship

The HEP-funded GARD magnet program has already spawned a number of opportunities to provide critical technologies for other programs in the Office of Science and U.S. industry. Continued support of a cutting-edge program that explores the limits of superconducting materials and magnets will create many new ones: for example, superconducting undulators that will improve the performance of future light sources, high field NMR magnets for research, development of viable HTS magnets for fusion reactors, and magnets with unique performance characteristics for next-generation accelerators. The HTS component of the program may ultimately resolve the chicken-or-egg paradox by demonstrating the viability of applications for HTS superconductors, thereby paving the way for expanding the use of these materials and creating markets that could drive cost down substantially.

4. MDP Will Advance International Collaboration

High energy physics is explicitly an international endeavor. The MDP will extend our collaboration outside the U.S. and further advance international cooperation in future large-scale science projects and exploitation of high-energy accelerators in particular. The U.S. LHC Accelerator Research Program (LARP) is a successful example of this. Developing close working relationships with international partners is a critical step towards building a worldwide collaboration that will be necessary for high energy physics to advance to the next stage. The magnitude of the challenge we face in constructing a next generation proton-proton collider exceeds the capacity and capabilities of any one region. Collaboration with international partners ensures a highly leveraged and complementary means of achieving the MDP goals. International collaboration is also a way to engage and highlight the capabilities of U.S. industry.

General guidance for international collaboration was given by the DOE Office of Science Associate Director for High Energy Physics in a presentation on March 23, 2015: “A ‘mutually beneficial’ R&D collaboration provides the most solid foundation for U.S. participation with DOE support.” Referring to future high-energy colliders, “We envision these machines as global partnerships; the community must help ensure this partnership is not one region exploiting developments in the others to promote regional/national goals. R&D efforts must have an appropriate balance of international and national goals.” MDP will provide a framework for coordination of international activities that will benefit DOE and the international HEP program.

Appendix B: HEPAP Recommendations

DOE HEPAP Accelerator R&D Subpanel Recommendations

Recommendation 5. Participate in international design studies for a very high-energy proton-proton collider in order to realize this Next Step in hadron collider facilities for exploration of the Energy Frontier. Vigorously pursue major cost reductions by investing in magnet development and in the most promising superconducting materials, targeting potential breakthroughs in cost-performance.

Recommendation 5a. Support accelerator design and simulation activities that guide and are informed by the superconducting magnet R&D program for a very high-energy proton-proton collider.

Recommendation 5b. Form a focused U.S. high-field magnet R&D collaboration that is coordinated with global design studies for a very high-energy proton-proton collider. The over-arching goal is a large improvement in cost-performance.

Recommendation 5c. Aggressively pursue the development of Nb₃Sn magnets suitable for use in a very high-energy proton-proton collider.

Recommendation 5d. Establish and execute a high-temperature superconducting (HTS) material and magnet development plan with appropriate milestones to demonstrate the feasibility of cost-effective accelerator magnets using HTS.

Recommendation 5e. Engage industry and manufacturing engineering disciplines to explore techniques to both decrease the touch labor and increase the overall reliability of next-generation superconducting accelerator magnets.

Recommendation 5f. Significantly increase funding for superconducting accelerator magnet R&D in order to support aggressive development of new conductor and magnet technologies.

Recommendation C1a. Ramp up research and development of superconducting magnets, targeted primarily for a very high-energy proton-proton collider, to a level that permits a multi-faceted program to explore possible avenues of breakthrough in parallel. Investigate additional magnet configurations, fabricate multi-meter prototypes, and explore low cost manufacturing techniques and industrial scale-up of conductors. Increase support for high-temperature superconducting (HTS) materials and magnet development to demonstrate the viability of accelerator-quality HTS magnets for a very high-energy collider.

Appendix C: Acronyms and Abbreviations

CCT	Canted Cosine-Theta
MDP	Magnet Development Program
BCT	Block Cosine-Theta
CPRD	Conductor Procurement and R&D
HTS	High Temperature Superconductor
CORC	Conductor On Round Core
P5	Particle Physics Project Prioritization Panel
FCC	Future Circular Collider
SppC	Super Proton-proton collider
HEPAP	High Energy Physics Advisory Panel
GARD	General Accelerator R&D
LARP	LHC Accelerator Research Program
LHC	Large Hadron Collider
YBCO	Yttrium Barium Copper Oxide
REBCO	Rare Earth Barium Copper Oxide
TAC	MDP Technical Advisory Committee
IGBT	Insulated Gate Bipolar Transistor

Appendix D: DOE MDP Creation Guidance Memo



Department of Energy

Washington, DC 20585

NOV 23 2015

Dr. James Symons
Associate Laboratory Director for Physical Science
Lawrence Berkeley National Laboratory
1 Cyclotron Road
Berkeley, CA 94720

Dear Dr. Symons:

Following the release of the Accelerator R&D Subpanel Report in April of 2015, the DOE Office of High Energy Physics convened a workshop on July 28, 2015 aimed at the GARD high field magnet activity. The meeting brought together HEP management, GARD program managers, principal investigators in the present GARD superconductor portfolio, and a few outside observers from the broader research community and from HEPAP to present their views. A summary of the workshop outcome was issued by DOE-OHEP on January 27, 2016. Prior to the summary report, a memo was distributed by DOE-OHEP that gave guidance to a new nationally coordinated magnet program.

The U.S. Department of Energy (DOE) has supported the construction of the Large Hadron Collider (LHC) at the European Center for Particle Physics (CERN) under the terms of the International Cooperation Agreement between CERN and the U.S. and its Protocols. The compelling LHC results obtained thus far strongly support extending the LHC physics reach by continuing research and development with a goal of increasing the nominal accelerator luminosity by a factor of ten over the next several years; this R&D effort is referred to as the High Luminosity LHC (HL-LHC). The key technology studies to inform the proposed HL-LHC Accelerator upgrades are being conducted in the framework of the United States' LHC Accelerator Research Program (LARP).

We expect to meet U.S. commitments to the LHC and (eventually) the HL-LHC, but also desire to maintain U.S. leadership in critical technology R&D areas that enable future particle accelerator advances. Our management strategy to meet both of these goals is outlined below.

The Protocols provide that, during the LHC and HL-LHC running periods, U.S. scientists will participate as full partners in the LHC Research Program. In view of the great success of the LHC program and the considerable benefits it brings to U.S. science, we wish to continue the formal management structures that have enabled effective U.S. participation in the LHC effort. Accordingly, we request that Fermilab continue to serve as Host Laboratory for U.S. participation in the LHC Accelerator Research Program for the LHC and HL-LHC, consistent with the International Cooperation Agreement and Accelerator Protocol III. To ensure timely achievement of R&D milestones, we expect that Dr. Giorgio Apollinari will continue in his current role as manager of the LARP effort.

As Host Laboratory for these efforts, Fermilab would take the lead role with the U.S. accelerator community in developing plans and budgets for the LARP effort for the HL-LHC. In this role, Fermilab would also provide management oversight for these activities, including the preparation and execution of a LARP Management Plan. In addition, the bulk of LARP R&D activities will transition to an O413.b project that we will call the HL-LHC Accelerator Upgrade Project. After LARP completes the prototypes needed for the HL-LHC Accelerator Upgrade Project, HEP plans to continue just the visitors and training programs under the LARP framework.

The LARP and HL-LHC Accelerator Upgrade Project efforts should be planned to make optimal use of the infrastructure and expertise within the participating U.S.



National Laboratories and should be worked out with CERN on the basis of mutual interest. The planned LARP research is expected to include:

- Support for design, development, testing and commissioning of equipment for HL-LHC, such as high-field IR quads and advanced instrumentation; and
- Beam experiments aimed at both improved LHC performance and related beam physics questions.

We expect that support for agreed-to U.S. deliverables for the HL-LHC as noted above will largely saturate the available technical resources at Fermilab over the next several years. Delivering on commitments to such a high priority scientific effort will be of critical importance to the U.S. HEP program. Accordingly, we expect Fermilab management to focus on timely and efficient completion of these activities.

There is also interest in exploring options for far-future energy frontier colliders, and the U.S. has been a world leader in developing high-field magnet technology that enables this direction. Recognizing the priority of the HL-LHC effort, investments in such long-range R&D will necessarily be limited, and in particular Fermilab will have a limited role in this R&D.

Effective immediately, the Lead Laboratory for HEP R&D in high-field magnet technology will be Lawrence Berkeley National Laboratory (LBNL). LBNL should identify an appropriate manager for this activity. Analogous to the Fermilab role in LARP, LBNL will be expected to take the lead role with the U.S. accelerator community in developing research plans and budgets for high-field magnet R&D that can enable far-future energy frontier colliders (by which we mean machines with energies significantly greater than the full energy of the LHC). Optimal use of the infrastructure and expertise within the participating U.S. National Laboratories and coordination with the relevant R&D efforts of international partners is expected. Research priorities and milestones for the high-field magnet R&D effort should be proposed to and approved by the DOE HEP office.

We believe this split management model, with Fermilab concentrating on delivering the near-term magnet technology critical for HL-LHC and shepherding the supporting LARP effort; and LBNL focusing on long-term, high-risk and high-impact R&D, will generate the best outcomes for the U.S. HEP program.

We appreciate your continued support for, and attention to, these important activities.

Sincerely,

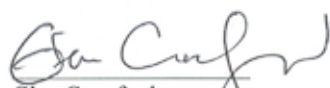

Glen Crawford
Director, Research and Technology Division
for High Energy Physics



Michael Procaro
Director, Facilities Division
for High Energy Physics

cc: Dr. Wim Leemans
Dr. Steven Gourlay



U.S. DEPARTMENT OF
ENERGY

Office of
Science



**U.S. MAGNET
DEVELOPMENT
PROGRAM**