

DOE/NSF-HEPAP/NSAC  
Neutrino Scientific Assessment Group  
“NuSAG”

2<sup>nd</sup> Report to NSAC/HEPAP  
G. Beier, P. Meyers – March 2/3, 2006

- NuSAG charge
- Physics of neutrino mass and mixing
- Experimental questions in neutrino oscillations
- Scientific assessment
- Recommendations for a program in neutrino oscillations

# The Physics of Neutrino Mass and Mixing

- Beyond-Standard-Model physics – today!
- Connections to Big Questions of HEP and cosmology
- Experiment-driven, with important new results every year
- A big US investment over the past 5 years is expected to produce some of the most important next results

## The next round

- Lots to do!
- A worldwide effort with much international collaboration
- A well-developed conceptual plan, with re-use of expensive existing facilities
- Opportunities for the US program to take a leading role and lift the worldwide program to a new, comprehensive level

## From the charge to NuSAG:

...we ask the NuSAG to make recommendations on the specific experiments that should form part of the broad U.S. neutrino science program.

Three specific charges:

### **Charge 2**

NuSAG is requested to address the APS Study's recommendation of a phased program of sensitive searches for **neutrino-less nuclear double beta decay**.

This was the subject of NuSAG's first report,  
September 1, 2005.

## Charge 1

We request that NuSAG address the APS Study's suggestion that the U.S. participate in “*An expeditiously deployed multidetector **reactor experiment** with sensitivity to  $\nu_e$  disappearance down to  $\sin^2 2\theta_{13}=0.01$ , an order of magnitude below present limits.*”

The options ... should include, but need not be limited to:

- A U.S. experiment (in Diablo Canyon, CA, **Braidwood**, IL, or elsewhere)
- U.S. Participation in a European reactor experiment (**Double Chooz** or elsewhere)
- U.S. participation in a Japanese experiment (**none active**)
- U.S. participation in a reactor experiment at **Daya Bay, China**

### Charge 3

We request that NuSAG address the APS Study's suggestion that the U.S. participate in “A *timely **accelerator experiment** with comparable  $\sin^2 2\theta_{13}$  sensitivity [to the recommended reactor experiment, i.e.,  $\sin^2 2\theta_{13}=0.01$ ] and **sensitivity to the mass-hierarchy** through matter effects.”*

The options ... should include, but not be limited to:

- U.S. participation in the **T2K** experiment in Japan
- Construction of a new off-axis detector to exploit the existing NuMI beamline from Fermilab to Soudan, as proposed by the **NOvA** collaboration
- As above but using a large **liquid argon detector**
- There are two US T2K efforts: B280 and 2km
- Liquid argon is currently directed to other applications

NuSAG should look at the **scientific potential** of each initiative, the **timeliness** of its scientific output together with the likely **costs to the U.S.**, and its place in the broad **international context**. In addition, **for the off-axis initiatives** (charge 3), the context should include a **consideration of what is likely to be learned from other experiments**, and the likely **future extensibility** of each option as **part of an evolving U.S. neutrino program**.

For all three charges NuSAG should then recommend a strategy of **one** (or perhaps more than one) experiment in that direction, which in its opinion should be pursued as part of the U.S. program.

## **Members of NuSAG**

Eugene Beier (University of Pennsylvania and Co-Chair)

Peter Meyers (Princeton University and Co-Chair)

Leslie Camilleri (CERN)

Boris Kayser (Fermi National Accelerator Laboratory)

Naomi Makins (University of Illinois)

Art McDonald (Queens's University) /

John Hardy (Texas A&M)

Tsuyoshi Nakaya (Kyoto University)

Natalie Roe (Lawrence Berkeley National Laboratory)

Guy Savard (Argonne National Laboratory)

Heidi Schellman (Northwestern University)

Gregory Sullivan (University of Maryland)

Petr Vogel (California Institute of Technology)

Bruce Vogelaar (Virginia Tech)

Glenn Young (Oak Ridge National Laboratory)

HEP/nuclear, expt/theory, US/not,  $\nu$  physics/not

# The new (old) paradigm: 3-ν mixing

$$\begin{pmatrix} \nu_e \\ \nu_\mu \\ \nu_\tau \end{pmatrix} = \begin{pmatrix} U_{e1} & U_{e2} & U_{e3} \\ U_{\mu1} & U_{\mu2} & U_{\mu3} \\ U_{\tau1} & U_{\tau2} & U_{\tau3} \end{pmatrix} \begin{pmatrix} \nu_1 \\ \nu_2 \\ \nu_3 \end{pmatrix}$$

With  $c_{ij} \equiv \cos \theta_{ij}$  and  $s_{ij} \equiv \sin \theta_{ij}$ :

|  | Reactor $\bar{\nu}_e$ |               | Majorana<br>CP phases |
|--|-----------------------|---------------|-----------------------|
| Atmospheric $\nu_\mu$  | Accelerator $\nu_\mu$ | Solar $\nu_e$ |                       |
| $U = \begin{bmatrix} 1 & 0 & 0 \\ 0 & c_{23} & s_{23} \\ 0 & -s_{23} & c_{23} \end{bmatrix} \times \begin{bmatrix} c_{13} & 0 & s_{13}e^{-i\delta} \\ 0 & 1 & 0 \\ -s_{13}e^{i\delta} & 0 & c_{13} \end{bmatrix} \times \begin{bmatrix} c_{12} & s_{12} & 0 \\ -s_{12} & c_{12} & 0 \\ 0 & 0 & 1 \end{bmatrix} \times \begin{bmatrix} e^{i\alpha_1/2} & 0 & 0 \\ 0 & e^{i\alpha_2/2} & 0 \\ 0 & 0 & 1 \end{bmatrix}$ |                       |               |                       |

$$\theta_{23} \approx \theta_{\text{atm}} \approx 45^\circ; \theta_{12} \approx \theta_{\text{sol}} \approx 34^\circ; \theta_{13} \leq 10^\circ$$

$\delta$  can lead to  $P(\nu_\alpha \rightarrow \nu_\beta) \neq P(\bar{\nu}_\alpha \rightarrow \bar{\nu}_\beta)$

(LSND not consistent with this picture)



# The mass hierarchies

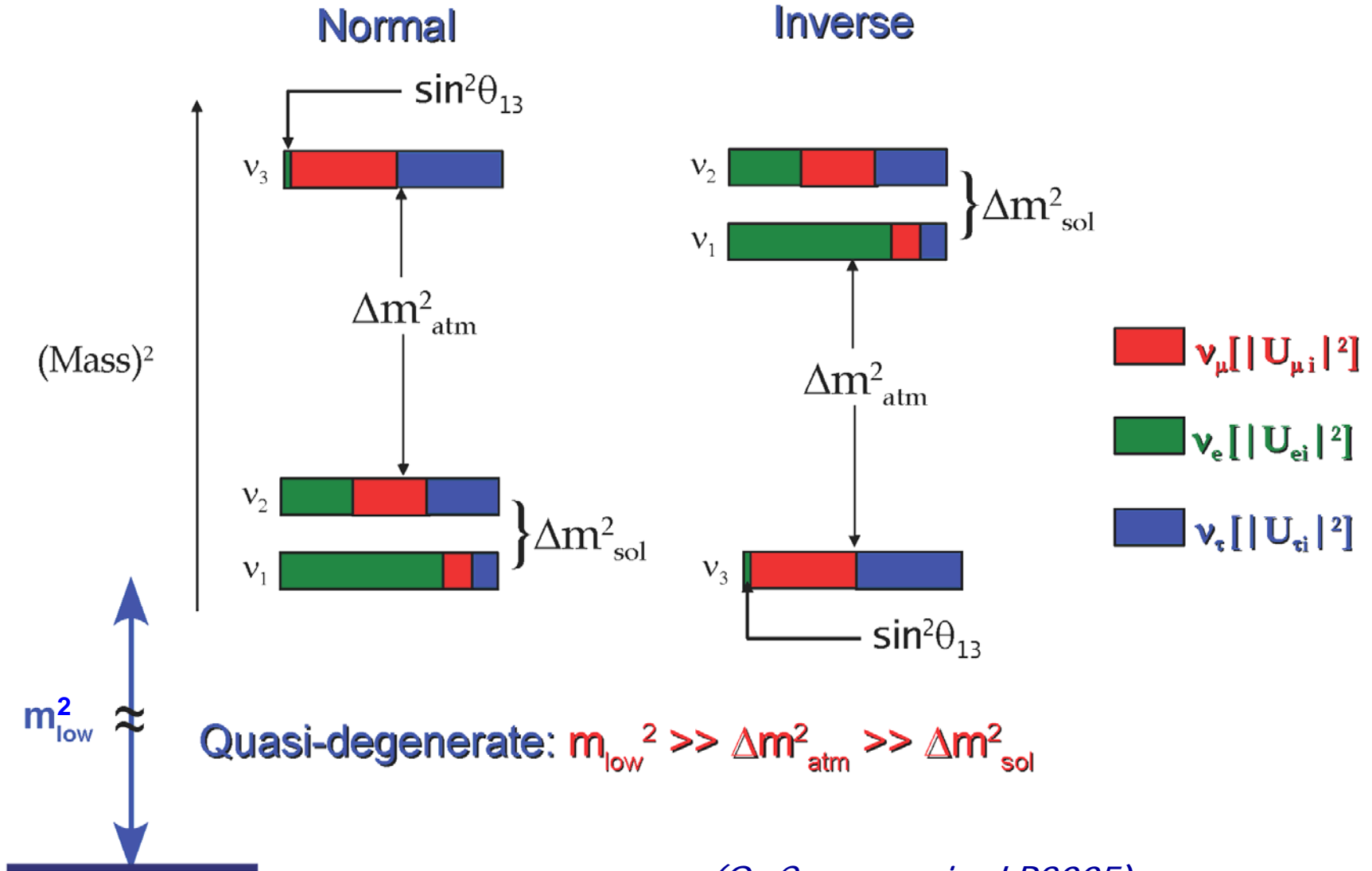

(O. Cremonesi – LP2005)

# Neutrino-less double beta decay

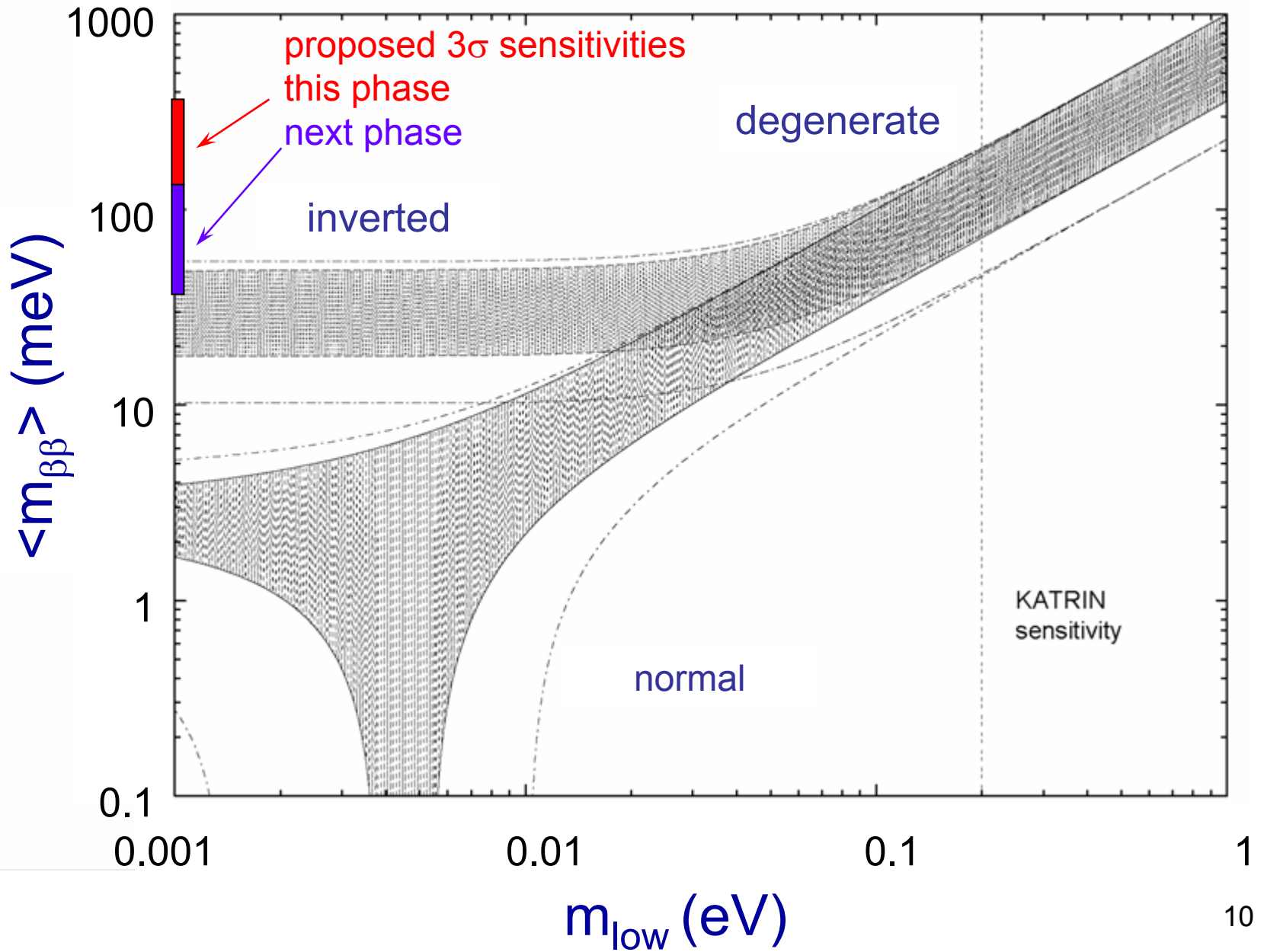

# Neutrino oscillation physics at accelerators and reactors

Solar:  $\nu_e \rightarrow \nu_\mu, \nu_\tau$ ,  $\Delta m^2 \sim 8 \times 10^{-5} \text{ eV}^2$ ,  $m_2 > m_1$

Atmospheric: mostly  $\nu_\mu \rightarrow \nu_\tau$ ,  $\Delta m^2 \sim 2.4 \times 10^{-3} \text{ eV}^2$

## Experimental questions for the Next Round

1. Further **confirm 3- $\nu$  mixing**: **predicts**  $\nu_e \leftrightarrow \nu_\mu$ , at **atmospheric**  $\Delta m^2$ , governed by  $\theta_{13}$ . **Is  $\theta_{13} > 0$ ?**
2. Is there **CP violation in leptons**:  **$\delta \neq 0, 180^\circ$ ?**
3. Mass hierarchy:  **$m_3 > m_{1,2}$ ?**
4. Is atmospheric mixing maximal,  **$\theta_{23} = 45^\circ$ ?**

These are all tangled together – the experiments before NuSAG propose to address 1 and 4 significantly and take the first steps in 2 and 3.

Accelerator  $\nu_\mu \rightarrow \nu_e$  appearance

$$\begin{aligned}
 P[\bar{\nu}_\mu \rightarrow \bar{\nu}_e] \cong & \sin^2 2\theta_{13} \sin^2 \theta_{23} \sin^2 \Delta_{31} \\
 & + \sin 2\theta_{13} \cos \theta_{13} \sin 2\theta_{23} \sin 2\theta_{12} \\
 & \sin \Delta_{31} \sin \Delta_{21} \cos(\Delta_{32} \pm \delta) \\
 & + \sin^2 2\theta_{12} \cos^2 \theta_{23} \cos^2 \theta_{13} \sin^2 \Delta_{21}
 \end{aligned}$$

(solar)

(unknowns)

(Arrows in the original image point from  $\nu$  to  $\Delta_{32} \pm \delta$  and from  $\bar{\nu}$  to  $\Delta_{21}$ )

( $\Delta_{ij} \equiv 1.27 \Delta m_{ij}^2 (eV^2) L(km) / E(GeV)$ )

Sensitivity to mass hierarchy via “matter effects”:

Passage through matter:

Normal: increases  $\nu_\mu \rightarrow \nu_e$ , decreases  $\bar{\nu}_\mu \rightarrow \bar{\nu}_e$

Inverted: decreases  $\nu_\mu \rightarrow \nu_e$ , increases  $\bar{\nu}_\mu \rightarrow \bar{\nu}_e$

Note:  $\sin 2\theta_{13}$  a factor in all the physics we are after!

Good news: sensitivity to all parameters of interest

Bad news: sensitivity to all parameters of interest

Off-axis beams for T2K and NOvA ~monoenergetic

→ ~one measurement for  $\nu$  + one for  $\bar{\nu}$

– but 3 or 4 unknowns

- Appearance itself: unambiguous discovery (but in general, no specific value for  $\theta_{13}$ ).
- Can measure  $\theta_{23}$  (with discrete ambiguity) via  $\nu_{\mu}$  disappearance.
- Different NOvA and T2K energies with same L/E → different matter effects (essentially zero for T2K) → resolve mass hierarchy.
- This extends reach for CP violation discovery.

- With  $<1$  MW beams (“Phase 1”), appearance itself and improved  $\theta_{23}$  in reach. Also, NOvA would have a modest reach in mass hierarchy resolution.
- With multi-MW beams, sensitivity to mass hierarchy and CP violation down to  $\sin^2 2\theta_{13} \sim 0.01$  (current limit  $\sim 0.12$ ).
- Both reactor- and accelerator-based programs aimed at this region.

# Reactor $\bar{\nu}_e$ disappearance

$$P[\bar{\nu}_e \rightarrow \text{Not } \bar{\nu}_e] \cong \sin^2 2\theta_{13} \sin^2 \Delta_{31} + \cos^4 \theta_{13} \sin^2 2\theta_{12} \sin^2 \Delta_{21}$$

small at max of first term

Good news: no sensitivity to  $\mathcal{CP}$  or mass hierarchy

Bad news: no sensitivity to  $\mathcal{CP}$  or mass hierarchy

- If disappearance seen, confirmation of paradigm and  $\sin^2 2\theta_{13}$  measured without ambiguity
- Combine with accelerator to resolve  $\theta_{23}$  ambiguity

To push below  $\sin^2 2\theta_{13} \sim 0.12$ ,

- all experiments use multiple detectors
- large experiments propose to swap detectors to further reduce systematic errors

# NOvA

- Uses existing Fermilab NuMI beam
- Baseline=810 km, 12 km ( $\sim 0.8^\circ$ ) off-axis  $\rightarrow E_\nu \sim 2$  GeV
- 30 kT far detector, liquid scintillator, 80%-active
- Movable near detector with same technology
- Has “Stage 1 approval” at FNAL
- Cost:  $\sim \$165$ M ( $\sim$ all US)

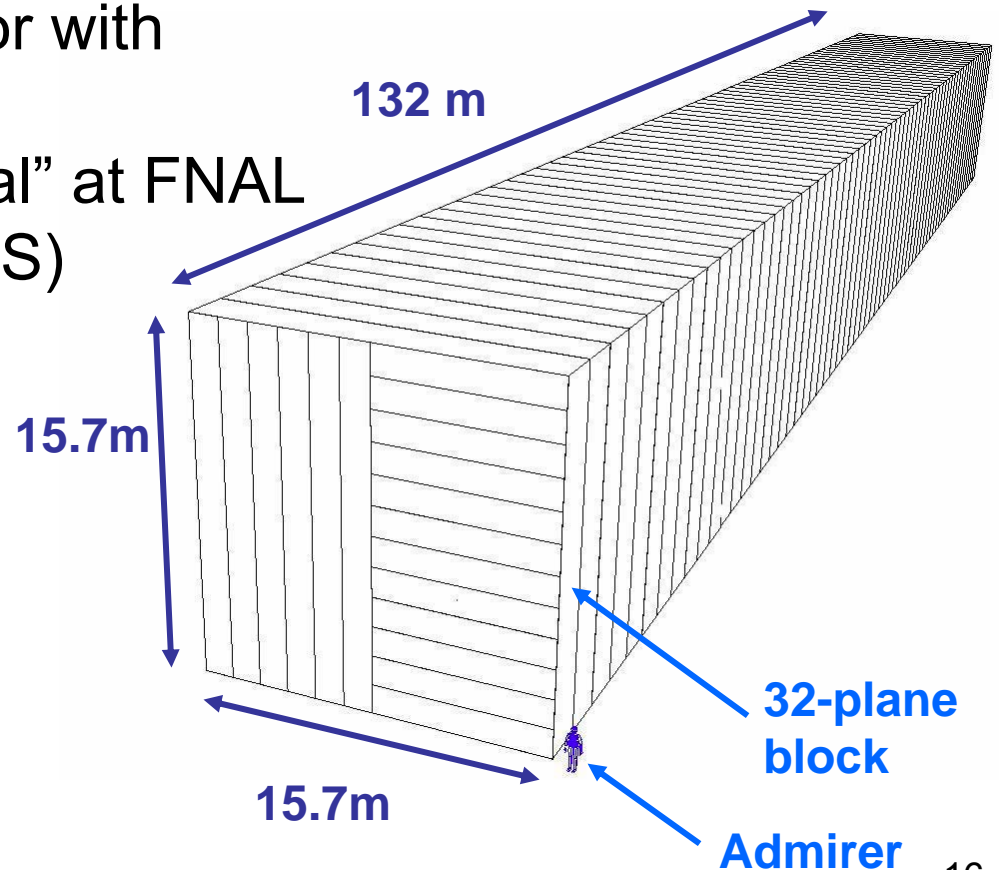



# T2K: Tokai to Kamioka

- Uses existing 50 kT Super-K as far detector
- New J-PARC accelerator under construction
- Baseline=295 km,  $2.5^\circ$  off-axis  $\rightarrow E_\nu \sim 0.6$  GeV

## T2K B280

- Neutrino beam, on-axis monitor, near detector at 280 m
- Near detector not water Cherenkov
- Approved in Japan, under construction
- US participation in beam and detectors
- Cost to US:  $\sim$ \$5M

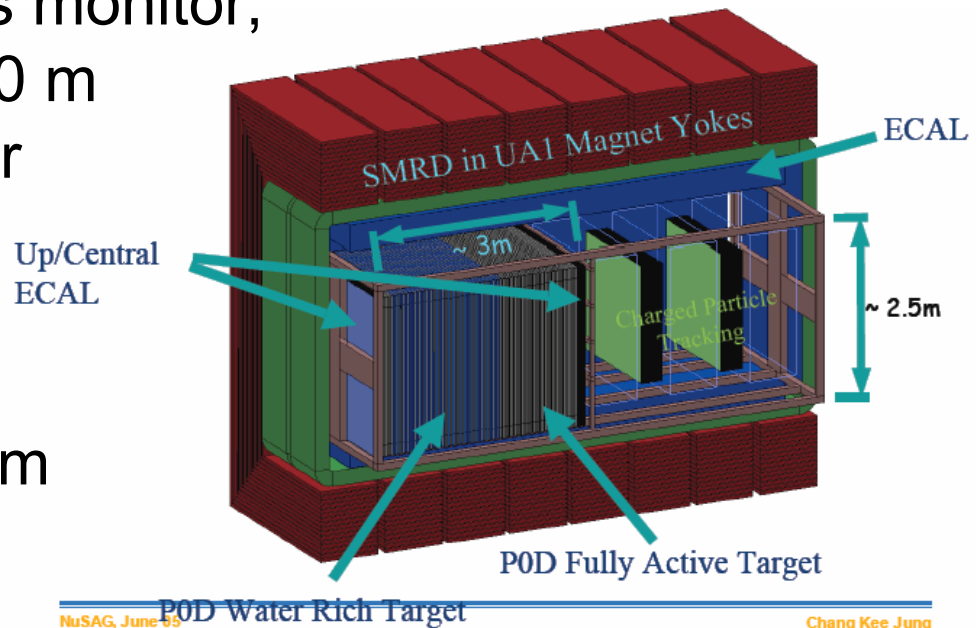

NuSAG, June 95

Chang Kee Jung

# T2K 2 km

- Proposal adds detector at 2 km
- 1 kT water Cherenkov + liquid argon TPC
- Near-identical spectra at 2 km and Super-K
- Not yet approved in Japan
- Cost to US ~\$12M

## Far/Near $\nu$ Flux Ratio vs. Detector Distance

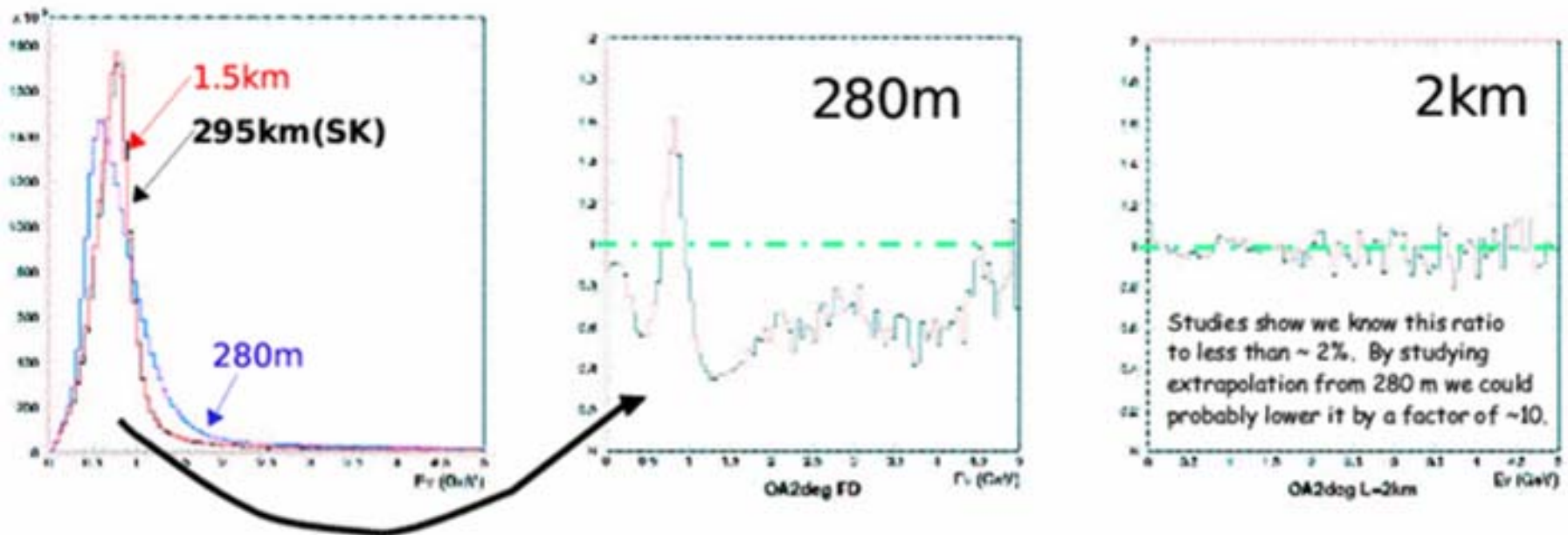

# Potential later phases of accelerator programs

- Not part of current approval process, but (explicit in NuSAG charge) potential adds to attractiveness of Next Round (“Phase 1”)

## Phase 2: Increase proton beam power

- Fermilab: 2 MW “Proton Driver” or incremental improvements toward ~1 MW
- T2K: increase to 4 MW

## Phase 3: Detector upgrade?

- Fermilab: 2<sup>nd</sup> detector? Multiple beams? VLBL?
- T2K: Hyper-K (0.5 MT)?

# Liquid Argon Detector R&D

- Liquid Argon TPC
- Motivation:
  - Better particle ID, tracking, efficiency
  - Roughly equivalent to 2×mass of other detectors
- R&D plan includes
  - 130 ton and
  - 1 kT prototypes
- A Phase 2-3 detector?

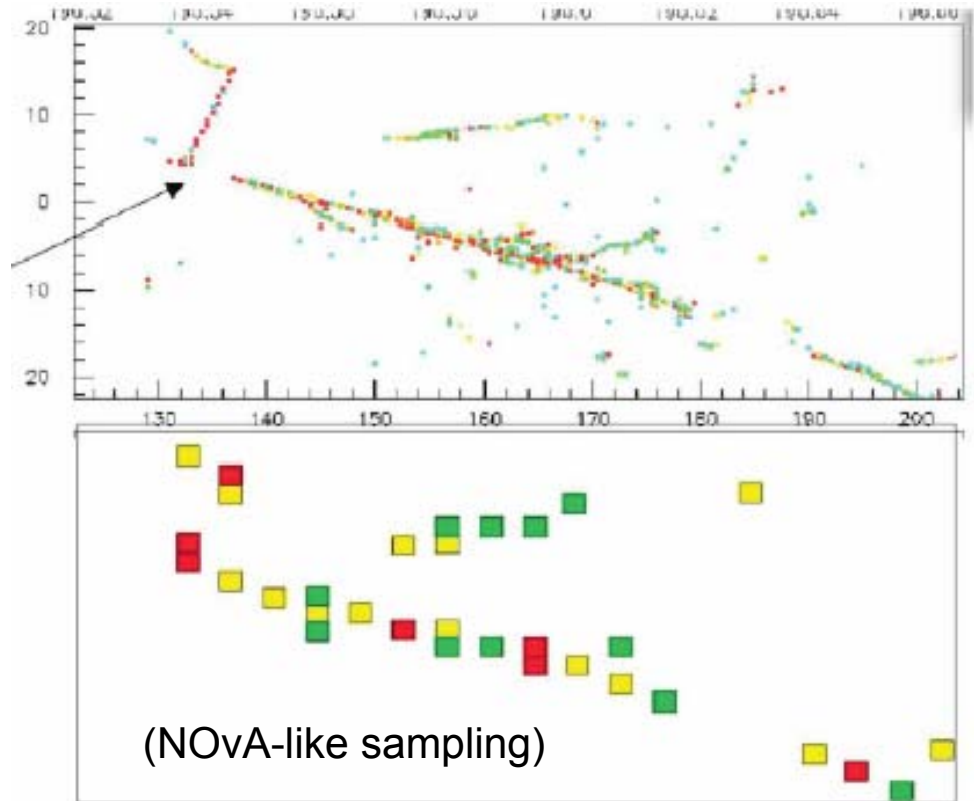

# 3 $\sigma$ Sensitivity to $\theta_{13} \neq 0$ (Comparisons by NOvA)

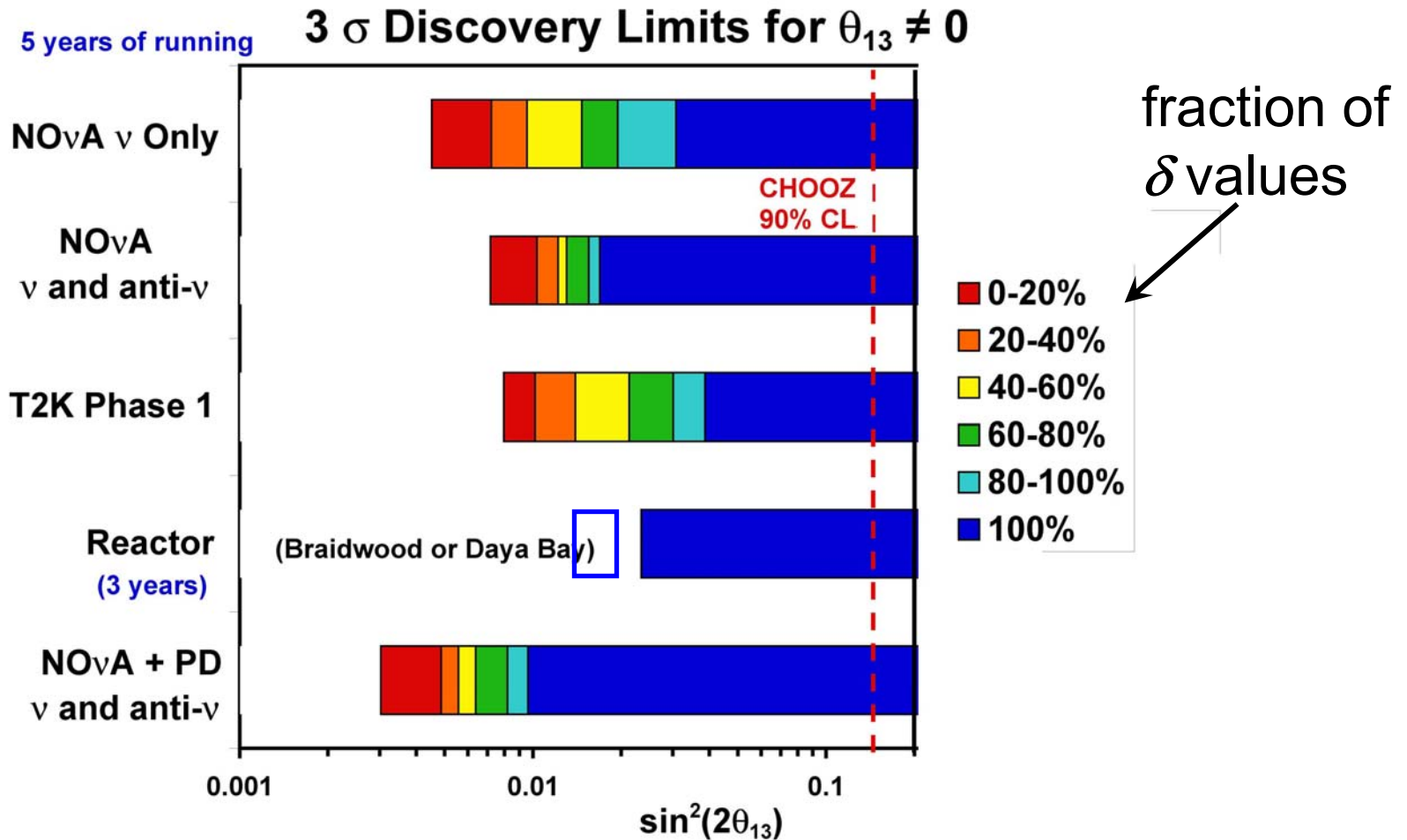

# 95% CL Resolution of the Mass Ordering: Summary

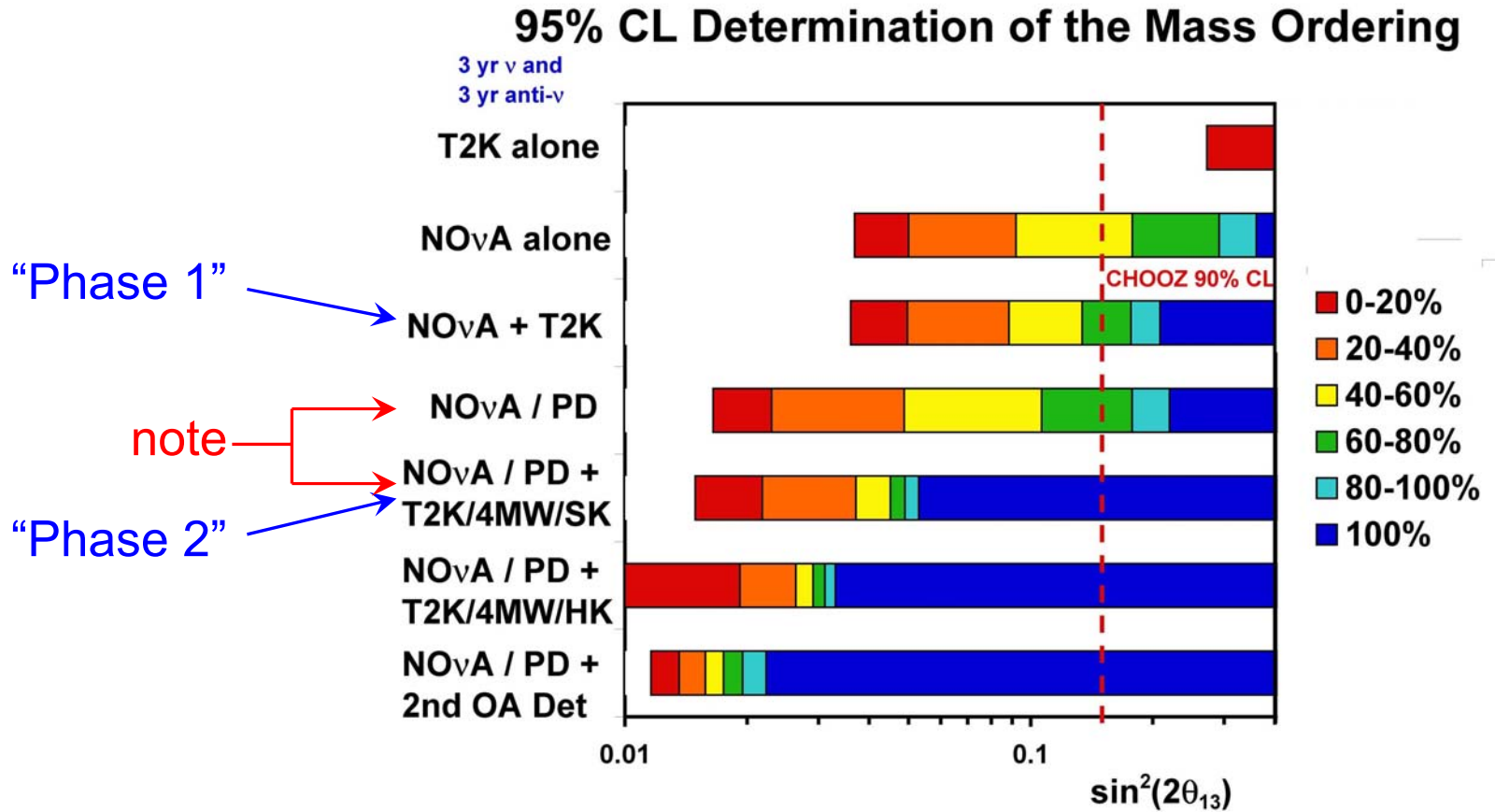

# 3 $\sigma$ Determination of CP Violation

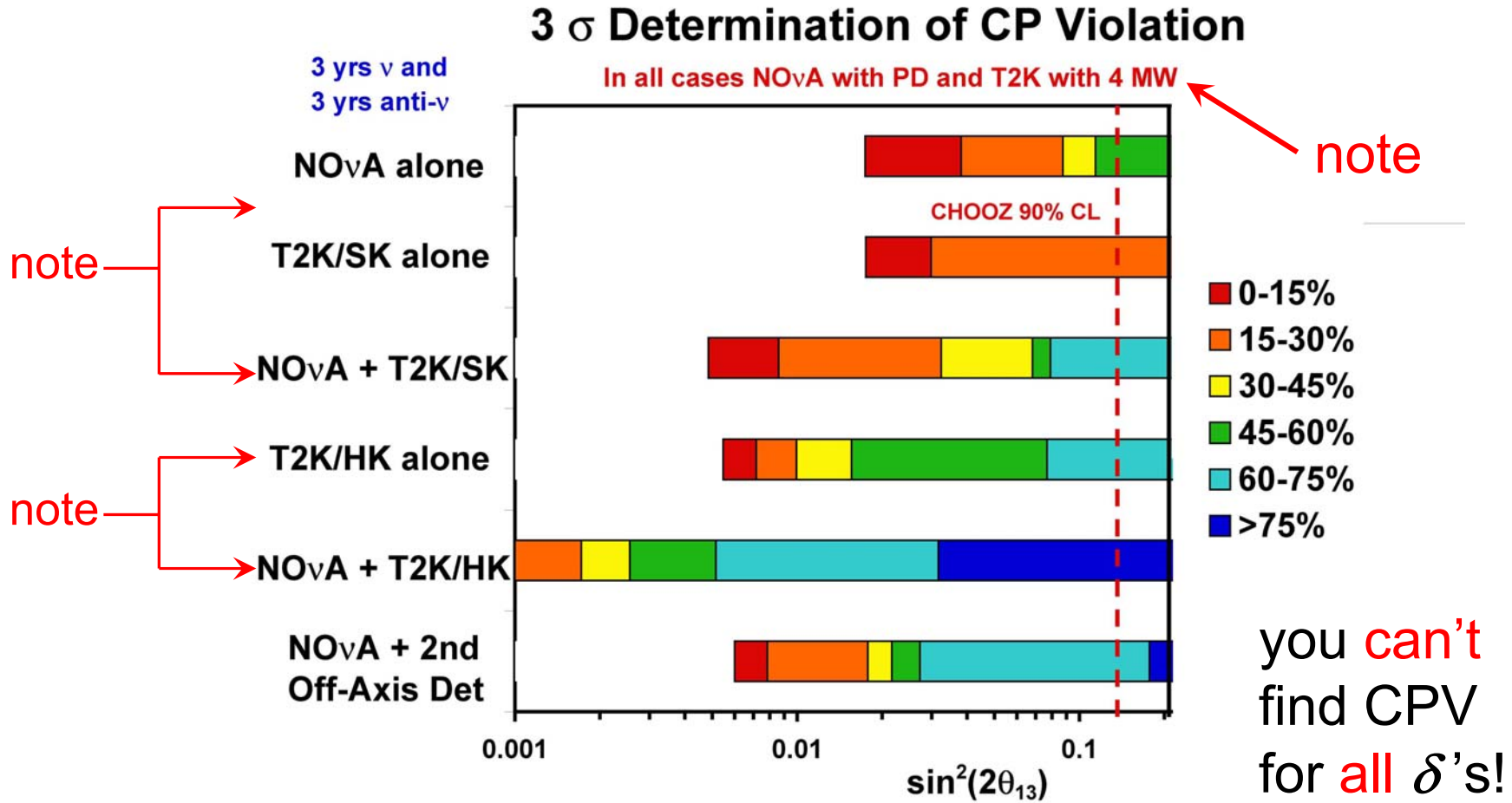

# Reactor proposals with US participation

|  | Double-Chooz<br>(France) | Braidwood<br>(Illinois) | Daya Bay<br>(China) |
|--|--------------------------|-------------------------|---------------------|
| Power ( $\text{GW}_{\text{th}}$ )                | 8.4                      | 7.2                     | 11.6→17.4           |
| Dist: near/far (m)                               | 100/1100                 | 270/1510                | ~500/~2000          |
| Depth: near/far<br>(m.w.e)                       | 60/330                   | 450/450                 | 330/1140            |
| Mass: near/far<br>(fiducial - tons)              | 12.7/12.7<br>no swap     | 2×65/2×65<br>swap       | 2×40/3×40<br>swap   |
| $\sin^2 2\theta_{13}$ 90%CL<br>sensitivity goal* | 0.02                     | 0.005                   | 0.008-0.006         |
| US cost (\$M)                                    | 5                        | 65                      | ~30?                |

\* Chooz limit ~0.12

(Thanks to Leslie Camilleri)<sup>24</sup>



# The Chooz Site

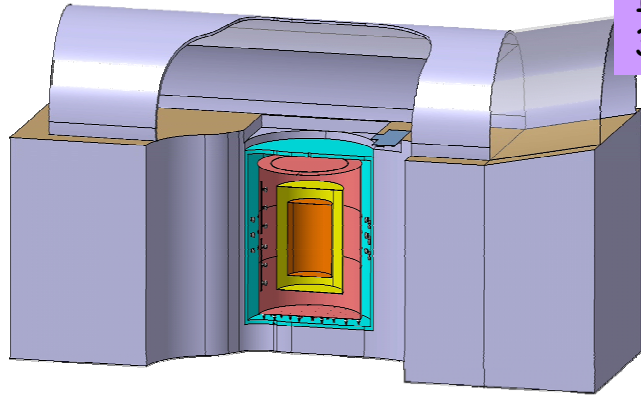

1100m Baseline  
300MWE Overburden

Chooz-far



Chooz-near

2 x 4200MW  
Reactors

# Braidwood Neutrino Experiment

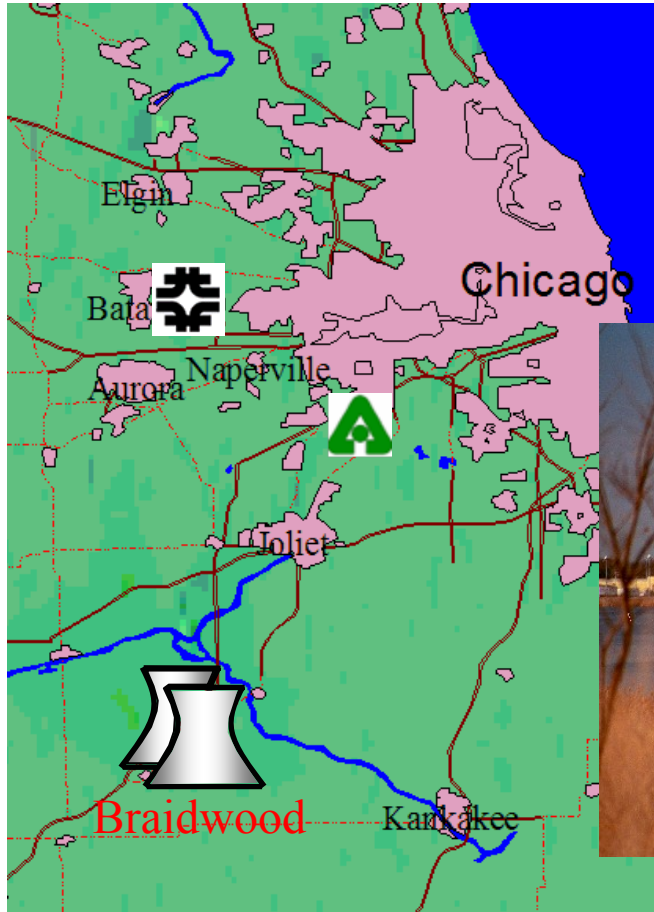

## Braidwood Setup:

- Two 3.6 GW reactors
- Two 65 ton (fid vol) near detectors at 270 m
- Two 65 ton (fid vol) far detectors at 1510 m
- 180m shafts and detector halls at 450 mwe depth

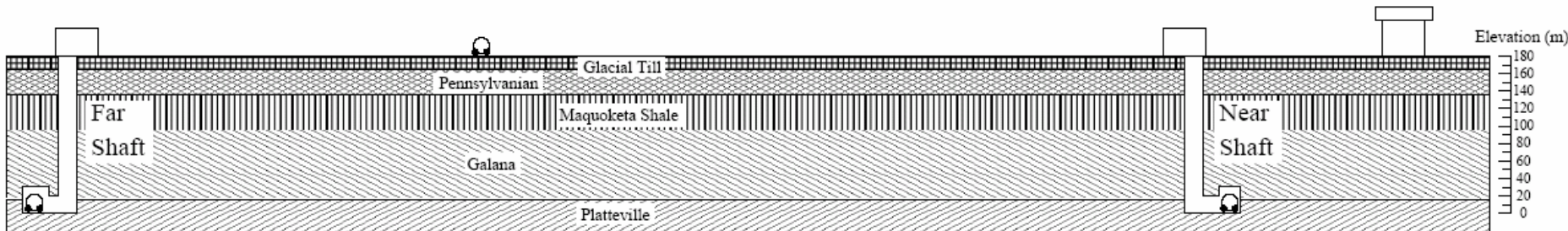

# Distances & Overburden

# Daya Bay, China

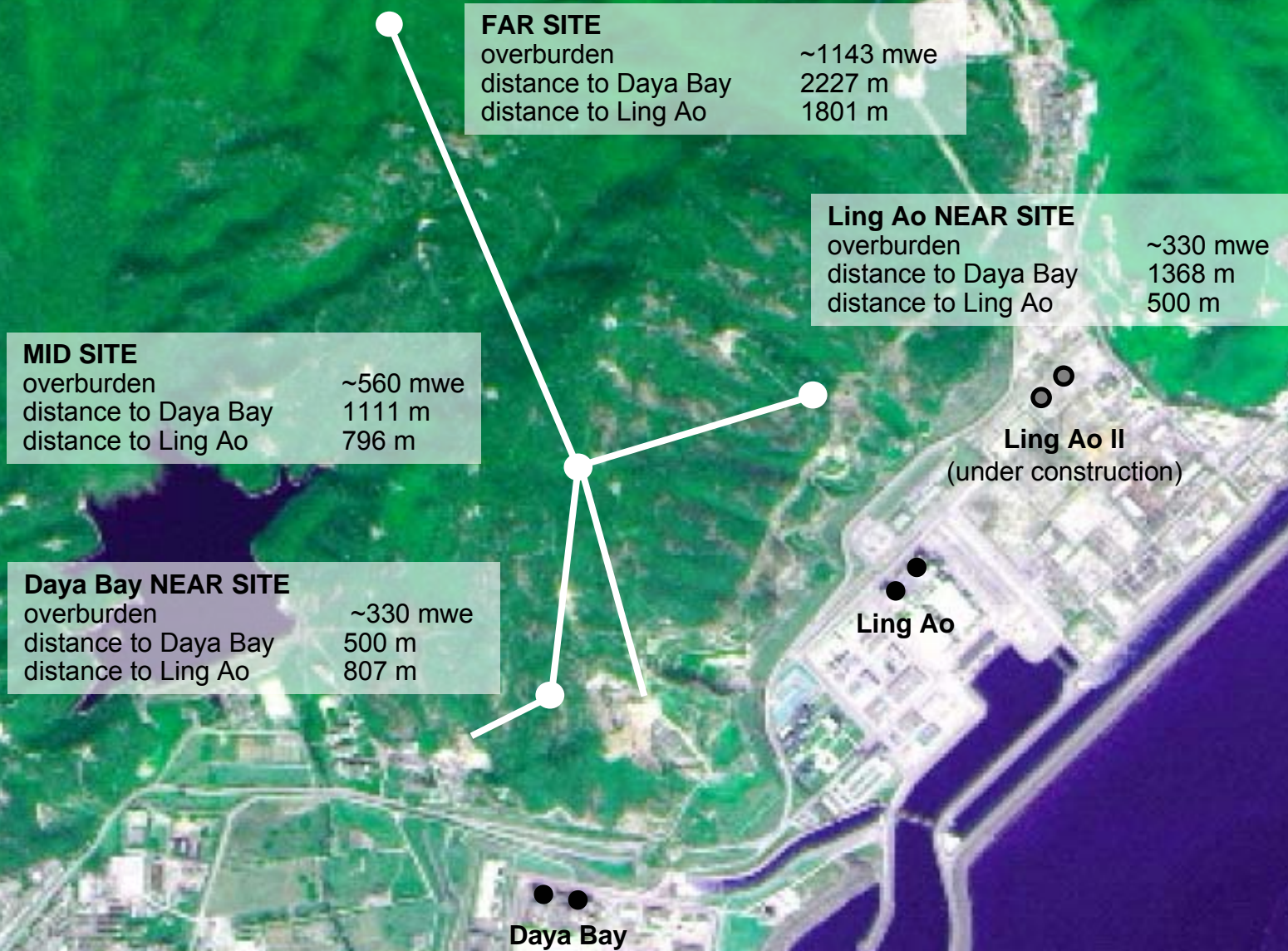

## Scientific Assessment

- All the experiments we looked at were well-motivated and scientifically interesting.
- The region  $\sin^2 2\theta_{13} > 0.01$  is a sensible target.
- Reactor not a faster path to  $\sin^2 2\theta_{13} \sim 0.01$ , but reactor and accelerator experiments give complementary information. Reactors measure fewer parameters, but without ambiguity.
- The experiments already under construction, T2K and Double Chooz, do not and cannot do all the physics here.

## Scientific Assessment

- NOvA and Braidwood/Daya Bay can add for  $\sin^2 2\theta_{13} > 0.01$ :
  - Mass hierarchy resolution
  - Reactor sensitivity  $\approx$  accelerator for non-zero  $\theta_{13}$
  - $\sin^2 2\theta_{13}$  determination, some ambiguity resolution
  - Substantial extension of CP violation sensitivity (with upgrades to NOvA and T2K)
- Braidwood and Daya Bay are scientifically very similar.
  - Advantage to Braidwood in symmetric layout
  - Complicated international/non-scientific issues
- Accelerator program is both enriched and complicated by future development paths.

# Recommendations (a risky summary – see the report!)

## 6.1 General

1. The US can and should be a leader of the worldwide experimental program in  $\nu$  oscillations
2. The US program should include both accelerator- and reactor-based experiments

In our specific recs, we tried to “prioritize” rather than “recommend a strategy of one”...

## 6.2 Accelerator

1. The US should conduct the NOvA experiment at Fermilab
2. The US should continue to play an important role in the Japanese program
  - Focus on T2K B280 in the short term
  - 2KM on appropriate timescale if possible
3. Support US R&D on LArTPC's to establish scalability to 10-30 kton

## 6.3 Reactor

1. The US should mount one multi-detector reactor experiment sensitive to  $\bar{\nu}_e$  disappearance down to  $\sin^2 2\theta_{13} \sim 0.01$ . Both Braidwood and Daya Bay meet the scientific need. One should be done.
2. External issues rather than sensitivity likely to be decisive
  - Determination of Daya Bay cost sharing with China must be clarified quickly
  - Full technical review needed for approval of either experiment
3. US participation in Double Chooz encouraged, but at lower priority



# The next round in neutrino oscillations

- Lots to do!
- A well-developed conceptual plan, with re-use of expensive existing facilities
- A worldwide effort with much international collaboration
- Opportunities for the US program to take a leading role and lift the worldwide program to a new, comprehensive level

**We should DO SOME EXPERIMENTS!**



# Recommendations for the U.S. program in neutrino oscillations

## General recommendations

**6.1.1** The United States can and should be a leader of the worldwide experimental program in neutrino oscillations.

**6.1.2** The U.S. program should include both accelerator- and reactor-based experiments.

## Recommendations on accelerator-based experiments

**6.2.1** The U.S. should conduct the NOvA experiment at Fermilab. The first phase of this experiment can compete successfully with the Japanese T2K program. If justified by Phase-1 results, both NOvA and T2K have potential later phases. The combination of the two programs is considerably more powerful than either alone, due to their different baselines. Particularly notable is NOvA's sensitivity to the mass hierarchy, unique among the experiments studied for this report.

**6.2.2** The U.S. should continue to play an important role in the Japanese neutrino program. This is a cost-effective element of the U.S. program and beneficial to the worldwide program. The U.S. participation in the T2K program should focus in the short term on the B280 effort. This is crucial to bringing the T2K experiment on line. The T2K 2KM project brings improved systematics that would be necessary in later phases of the T2K program. In the initial oscillation search, it would bolster confidence in an observation, especially if NOvA were not underway. U.S. participation on an appropriate time scale is supported if possible.

**6.2.3** The U.S. R&D program in Liquid Argon TPC's should be supported at a level that can establish if the technology is scalable to the 10-30 kiloton range. If workable, this technology will come into its own in the later phases of the long-baseline program.

## Recommendations on reactor experiments

**6.3.1** The United States should mount one multi-detector reactor experiment sensitive to  $\bar{\nu}_e$  disappearance down to  $\sin^2 2\theta_{13} \sim 0.01$ .

**6.3.2** Braidwood and Daya Bay have both made a good case that they could achieve the desired sensitivity, given their current level of technical maturity. The Braidwood experiment has somewhat more sensitivity due to the reduced systematic limitations associated with its simpler geometry. NuSAG did not carry out any detailed review of the costs presented by the two collaborations. Based on the information given us, the Braidwood estimate is further developed than Daya Bay's. It is likely that the cost sharing between the U.S. and China will lead to a lower cost to the U.S. program for Daya Bay. However, until this cost sharing is better defined, it is impossible to determine the relative cost of the two experiments.

Understanding that such a determination is necessary, NuSAG strongly recommends that this happen as quickly as possible, with timely R&D funding to further understanding of costs and schedules.



**6.3.3** Although it cannot perform its measurements to the sensitivity required by the broader program and thus has lower scientific priority than the larger reactor experiment, U.S. participation in Double Chooz is encouraged because of its relatively low cost and the opportunity to make early improvements in sensitivity.

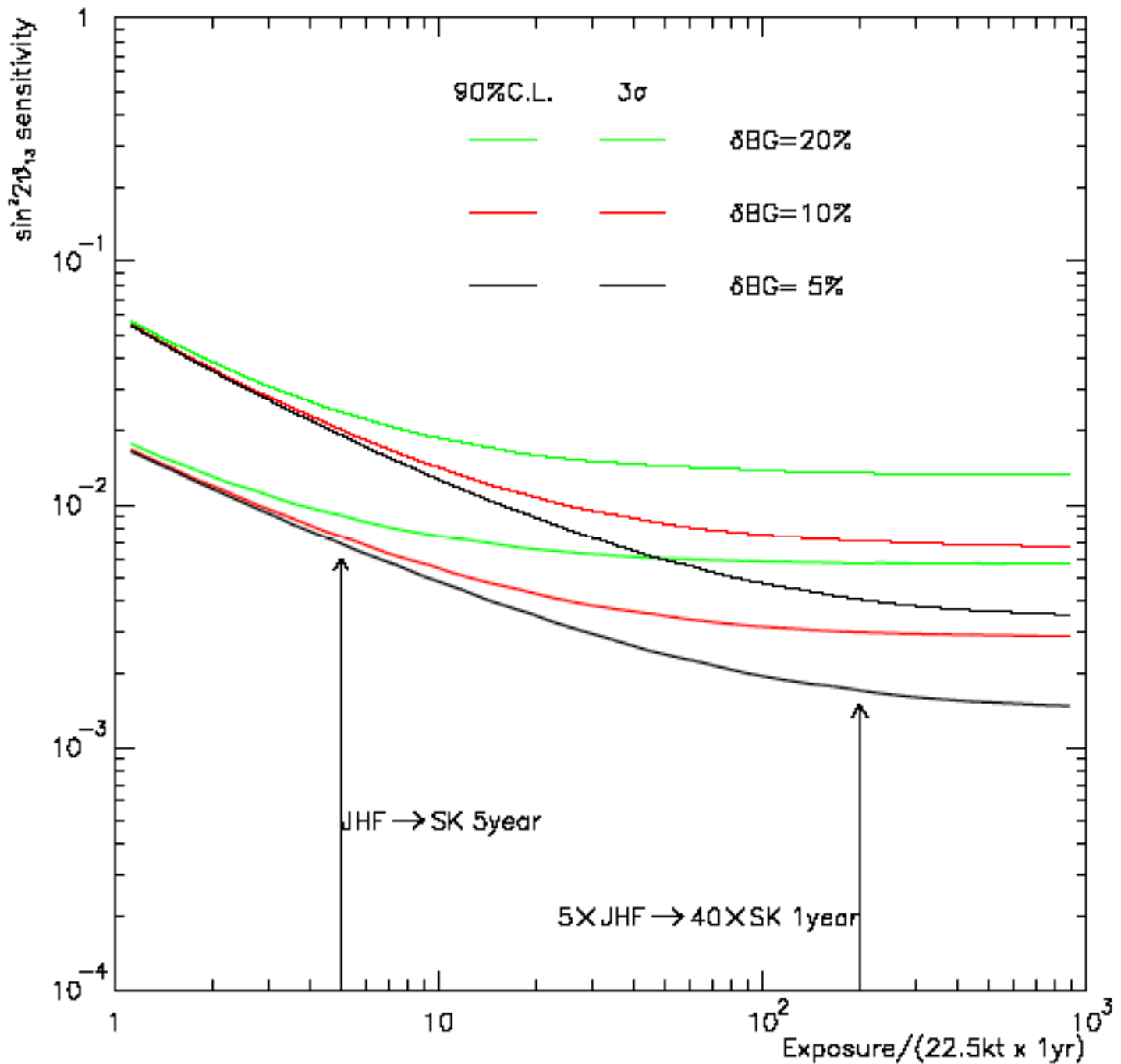

### 3 $\sigma$ Sensitivity to $\sin^2(2\theta_{13})$

