



U.S. DEPARTMENT OF
ENERGY

Office of
Science

FY 2013 Budget Request to Congress for DOE's Office of Science

March 9, 2012

NSAC

Dr. W. F. Brinkman
Director, Office of Science
U.S. Department of Energy

www.science.energy.gov

Office of Science

Science to Meet the Nation's Challenges Today and into the 21st Century

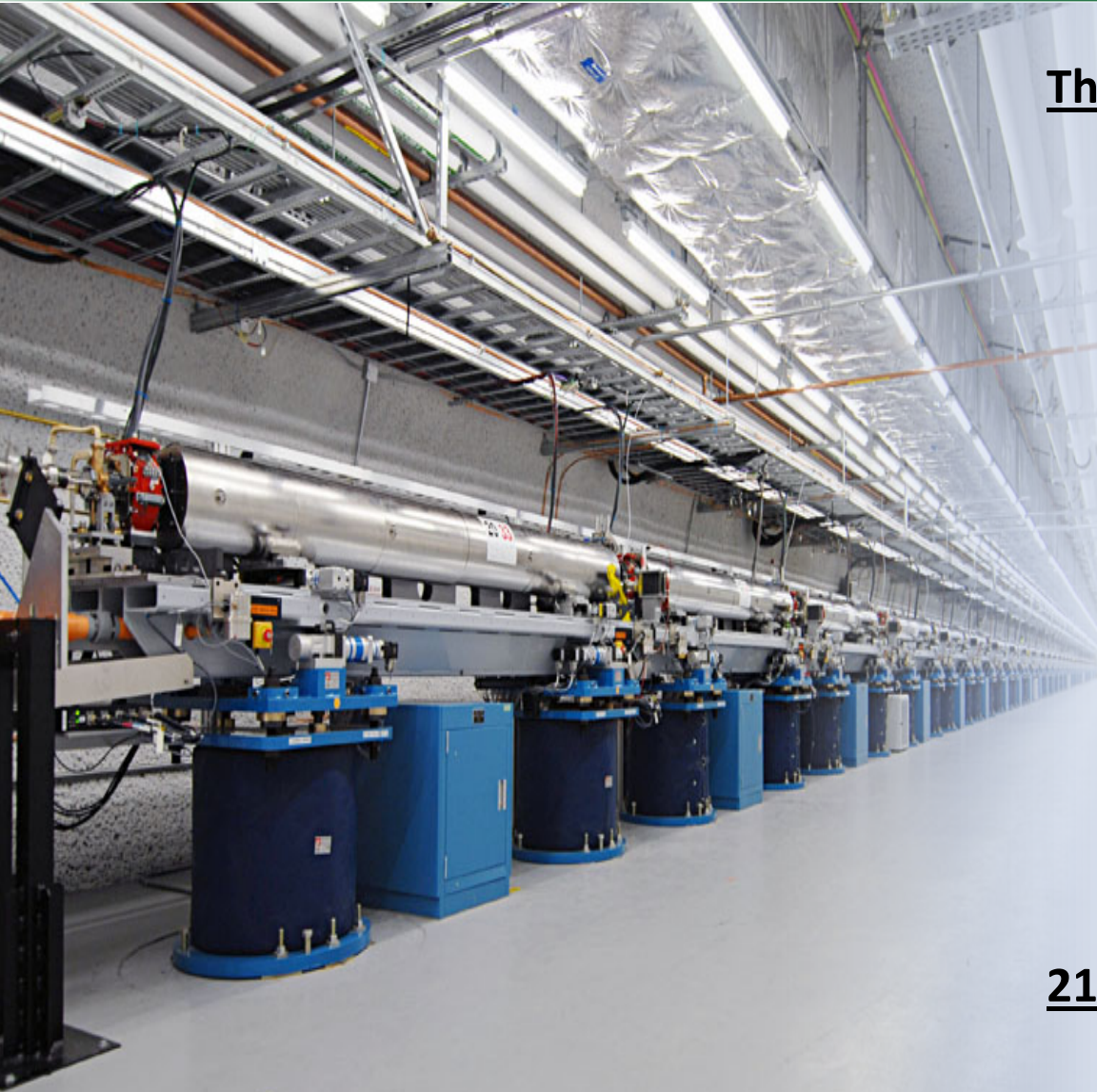

The Frontiers of Science

- Supporting research that led to over **100 Nobel Prizes** during the past **6 decades**—more than **20** in the past **10 years**
- Providing **45%** of Federal support of basic research in the physical and energy related sciences and key components of the Nation's basic research in biology and computing
- Supporting over **25,000 Ph.D.** scientists, graduate students, undergraduates, engineers, and support staff at more than **300** institutions

21st Century Tools of Science

- Providing the world's largest collection of scientific user facilities to over **26,500** users each year

The Dark Energy Program – 2011 Nobel Prize in Physics

Saul Perlmutter, Professor of Physics at the University of California, Berkeley, and senior scientist at Lawrence Berkeley National Laboratory (LBNL), was awarded the 2011 Nobel Prize in Physics. He led the Supernova Cosmology Project that, in 1998, discovered that galaxies are receding from one another faster now than they were billions of years ago.

He shared the prize with Adam G. Riess (Johns Hopkins University) and Brian Schmidt (Australian National University's Mount Stromlo and Siding Spring Observatories).



Saul Perlmutter , Physics Nobel Laureate, 2011, for the discovery of the accelerating expansion of the Universe through observations of distant supernovae.

Science, Innovation, and DOE's Office of Science

- Science is the basis of technology and underpins America's energy future.
- Science of the 20th century brought us the high standard of living we now enjoy. Today, we are laying the foundations for the new technologies of the coming decades.
- Progress in science and technology depends on continuing advances in, and replenishment from, basic research, where the federal government—and SC—plays a unique role.
- A highly trained work force is required to invent the future—scientists and engineers trained in the most modern science and technologies and with access to the best tools.



“Innovation is what America has always been about.”



Remarks of President Barack Obama
State of the Union Address to the Joint Session of Congress
Tuesday, January 24, 2012

“Innovation ... demands basic research.Don’t gut these investments in our budget. Don’t let other countries win the race for the future. Support the same kind of research and innovation that led to the computer chip and the Internet; to new American jobs and new American industries.

Nowhere is the promise of innovation greater than in American-made energy.”



Office of Science Research Underpins the President's Goals

- The Office of Science commands an arsenal of basic science capabilities—major scientific user facilities, national laboratories, and researchers—that we are using to break down the barriers to new energy technologies.
- We have focused these capabilities on critical national needs, e.g., through the Bioenergy Research Centers, the Energy Frontier Research Centers, the Combustion Research Facility, the Joint Genome Institute, the five Nanoscience Centers, and the new Energy Innovation Hubs.

Science for Innovation and Clean Energy

Applications of 21st century science to long-standing barriers in energy technologies: employing nanotechnology, biotechnology, and modeling and simulation:

- **Materials and chemical processes by design** using nanoscale and mesoscale structures for scientific advances and manufacturing innovations in solar energy conversion; clean-energy electricity generation; battery and vehicle transportation; and carbon capture, use, and sequestration.
- **Biosystems by design** targeting the development of synthetic biology tools and technologies and integrative analysis of experimental genomic science datasets for the design and construction of improved biofuels and bioproducts.
- **Modeling and simulation** using SC's Leadership Computing Facilities and production computing facilities to advance materials and chemistry by design and to broadly address energy technology challenges.

High-power Electrodes for Lithium-Ion Batteries

Electrode composite:

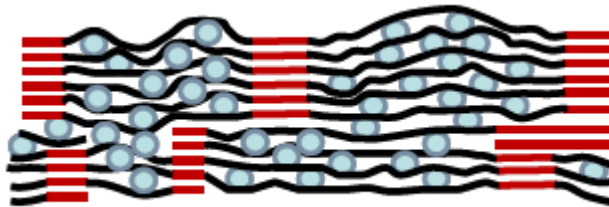

○ = Si nanoparticles
(provide high charge capacity)

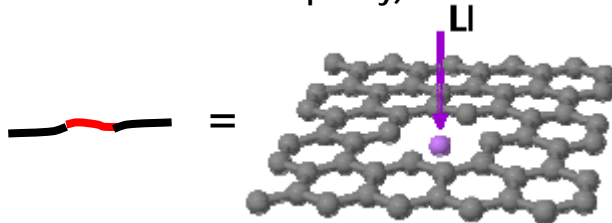

graphene sheet of C with in-plane defects
(provide high power)

Scientific Achievement

The holey graphene creates shorter lithium diffusion paths for fast charging, and the nanoparticle configuration avoids the problem of cracking during lithiation/delithiation experienced by bulk silicon.

Significance and Impact

10X greater capacity (3,200 mAh/g) than a conventional lithium-ion anode using graphite while maintaining mechanical stability

Work was performed at Northwestern University and supported by the Center for Electrical Energy Storage EFRC.

Xin Zhao, Cary M. Hayner, Mayfair C. Kung, and Harold Kung.,
Adv. Energy Mater., **2011**, 1, 1079-1084

Synthetic Biology for Genome Scale Editing

- New advances in synthetic biology have resulted the first full scale editing of a genome in a living cell.
- Using the model microbe *E. coli*, researchers were able to make large scale modifications to the cell's basic genetic coding language
- These results open the door to high throughput methods to treat genomes as editable templates, allowing for:
 - More sophisticated engineering of properties such as photosynthetic efficiency or biofuels synthesis
 - Large scale genetic manipulations enabling predictive biology research
 - Development of novel biocontainment strategies

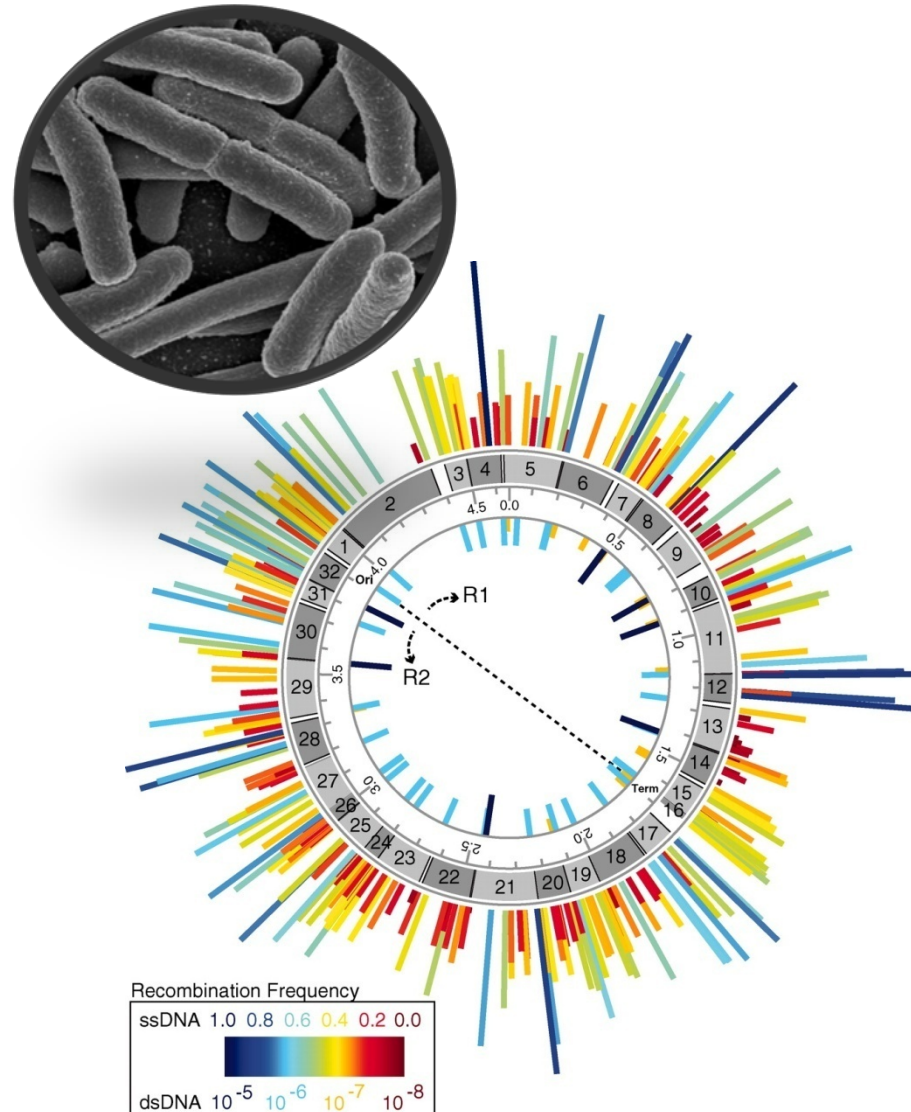

Office of Science FY 2013 Budget Request to Congress

	FY 2011 Current Approp.	FY 2012 Current Approp.	FY 2013 President's Request	FY 2013 Request vs FY 2012
Advanced Scientific Computing Research	410,317	440,868	455,593	+14,725
Basic Energy Sciences	1,638,511	1,688,093	1,799,592	+111,499
Biological and Environmental Research	595,246	609,557	625,347	+15,790
Fusion Energy Sciences	367,257	400,996	398,324	-2,672
High Energy Physics	775,578	790,860	776,521	-14,339
Nuclear Physics	527,684	547,387	526,938	-20,449
Workforce Development for Teachers and Scientists	22,600	18,500	14,500	-4,000
Science Laboratories Infrastructure	125,748	111,800	117,790	+5,990
Safeguards and Security	83,786	80,573	84,000	+3,427
Program Direction	202,520	185,000	202,551	+17,551
Subtotal, Office of Science	4,749,247	4,873,634	5,001,156	+127,522
Other	148,036	...	-9,104	-9,104
Total, Office of Science	4,897,283	4,873,634	4,992,052	+118,418



Nuclear Physics

Discovering, exploring, and understanding all forms of nuclear matter

The Scientific Challenges:

Understand:

- The existence and properties of nuclear matter under extreme conditions, including that which existed at the beginning of the universe
- The exotic and excited bound states of quarks and gluons, including new tests of the Standard Model
- The ultimate limits of existence of bound systems of protons and neutrons
- Nuclear processes that power stars and supernovae, and synthesize the elements
- The nature and fundamental properties of neutrinos and neutrons and their role in the matter-antimatter asymmetry of the universe

FY 2013 Highlights:

- Operations and research at three nuclear science user facilities (RHIC, CEBAF, ATLAS)
- 12 GeV CEBAF Upgrade to study systems of quarks and gluons and the force that creates protons and neutrons.
- Continued preparation for construction of the Facility for Rare Isotope Beams to study the limits of nuclear existence.
- Research, development, and production of stable and radioactive isotopes for science, medicine, industry, and national security.
- New strategic planning activity begins in FY 2012.

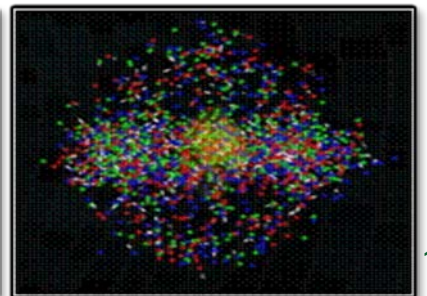
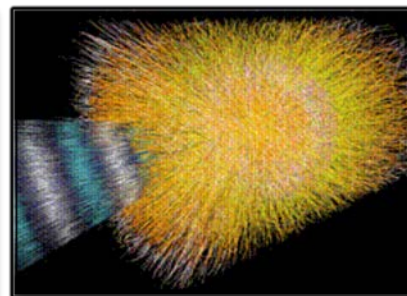
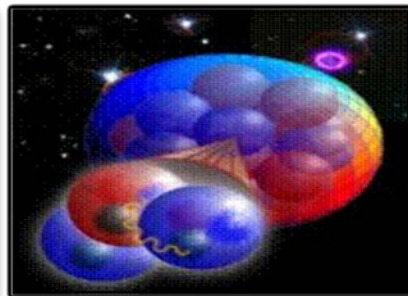
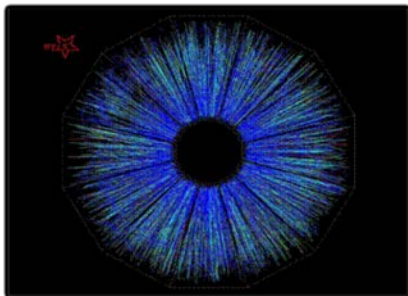

Heaviest Anti-Nucleus Ever Observed Discovered at RHIC



The graph below shows particle counts by mass, showing ordinary helium nuclei (^3He and ^4He) in orange, and their antimatter counterparts (antihelium-3 and antihelium-4) in blue. The newly discovered antimatter nuclei, antihelium-4, are clearly separated from the lighter isotopes, and are at the correct mass.

This discovery (*Nature* **473** (2011) 353) shows that complex anti-nuclei will form if enough anti-protons and anti-neutrons are present.

It underscores a grand challenge question of modern science: what process in the early universe resulted in more matter than anti-matter being present today?

Third in the Discover Magazine Top Ten Physics and Math Stories for 2011: “Helium’s Anti-Matter Twin Created”

Against one in 28 billion odds, two anti-protons and two anti-neutrons combine in RHIC collisions to form anti-helium 4, the heaviest anti-nucleus ever observed.

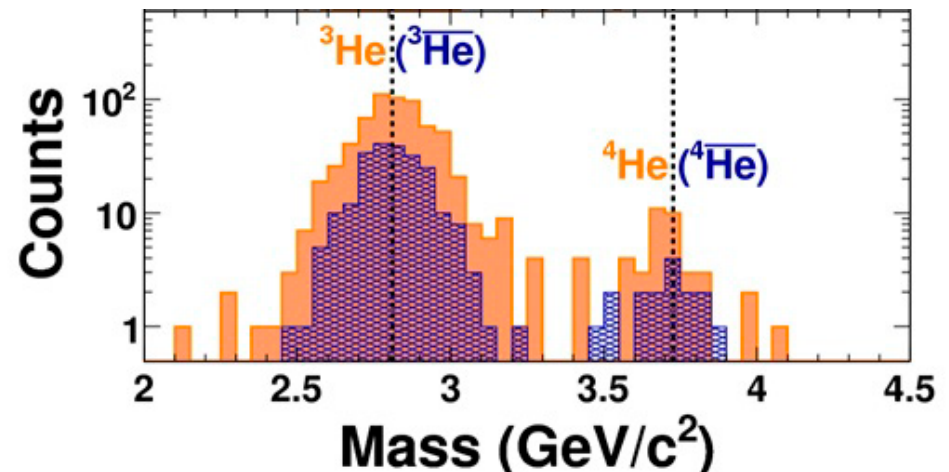

First Trapping of Anti-hydrogen Atoms

Fundamental symmetries that lie at the heart of the standard model of particle physics will be explored by comparing matter to its counterpart

- Precision studies of matter–antimatter symmetry will aid our understanding of the universe and the forces of nature
- The project is overcoming the difficult challenges of confining plasmas of neutral and charged particles in overlapping regions, as well as maintaining sufficiently low energy to trap the anti-matter atoms

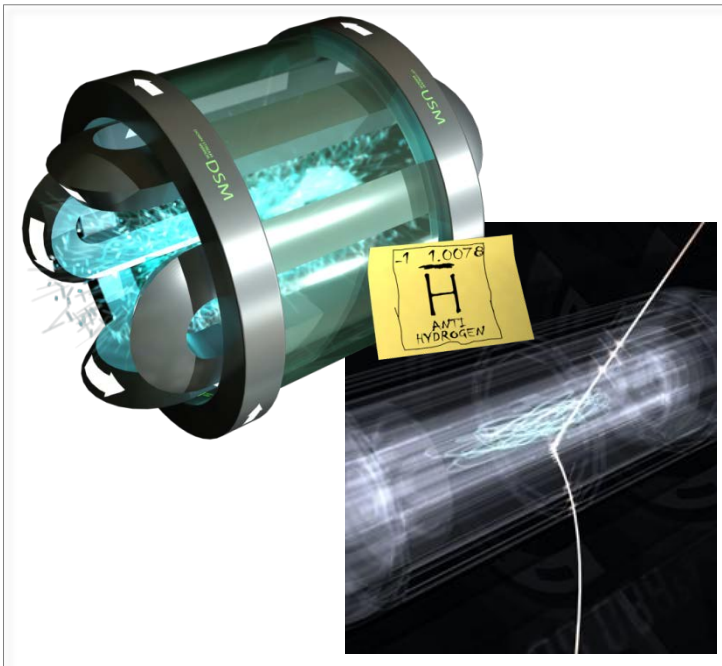

- Over 300 anti-hydrogen atoms were trapped, some for up to 1,000 seconds (almost 17 minutes)
 - Ground state anti-hydrogen atoms were created and confined
 - Lifetime is adequate to perform anti-atom studies related to **charge-parity-time reversal (CPT) symmetry**
 - Trapped anti-atoms are detected by turning off the confining magnetic field and allowing the particles to annihilate on the walls, creating a flash of light.

Nature Physics [doi:10.1038/nphys2025](https://doi.org/10.1038/nphys2025) (2011)



First Heavy Ion Results at LHC Confirm A New State of Matter is Produced in Relativistic Nucleus-Nucleus Collisions

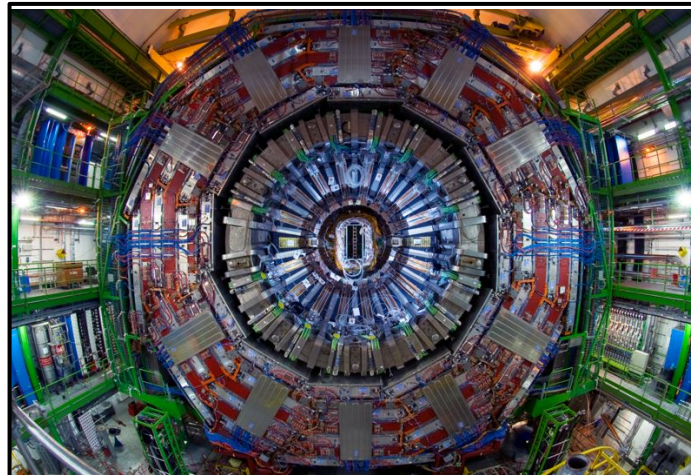
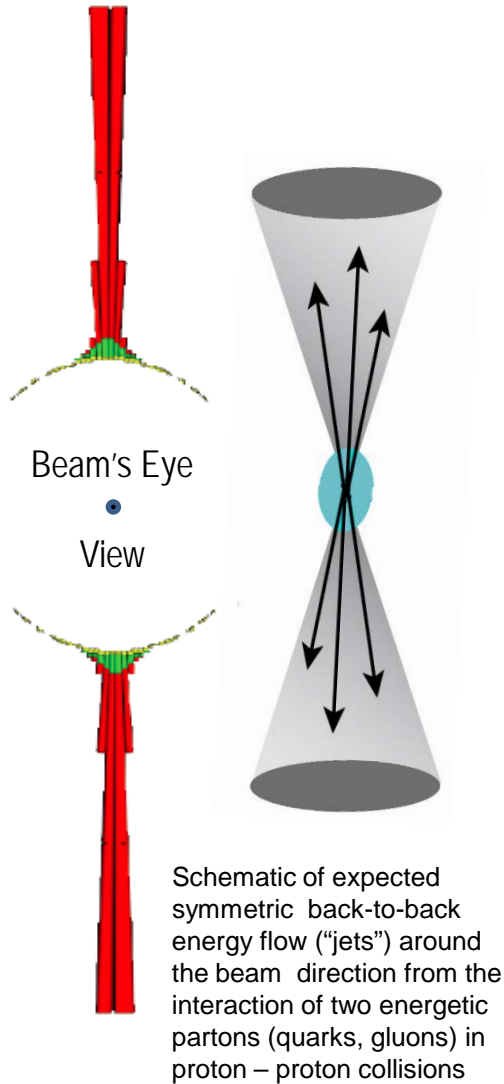

Heavy ion data at the LHC indicate a new state of opaque, strongly interacting matter similar to that first discovered at RHIC is produced in heavy ion collisions. "Jets" of energetic particles that traverse the new form of matter are disrupted (right) unlike in proton-proton collisions (left).

The results show that this new form of matter, believed to have influenced the evolution of the early universe, has unique properties and interacts more strongly than any matter previously produced in the laboratory.

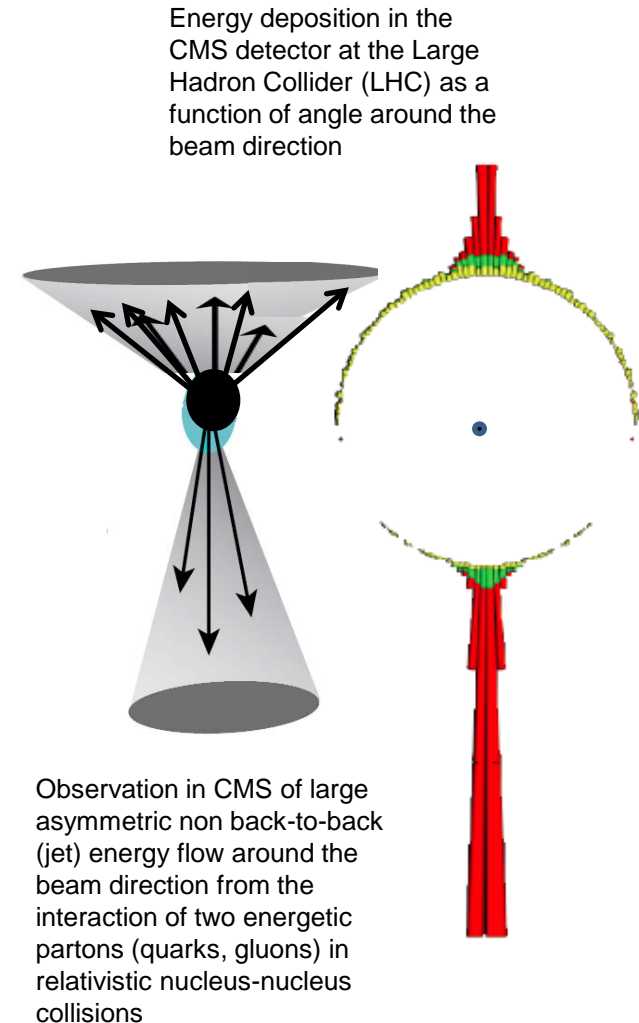

The 12 GeV CEBAF Upgrade at TJNAF 60% Complete.

With the completion of the 12 GeV CEBAF Upgrade, researchers will address:

- The search for exotic new quark-anti-quark particles to advance our understanding of the strong force
- Evidence of new physics from sensitive searches for violations of nature's fundamental symmetries
- A detailed microscopic understanding of the internal structure of the proton, including the origin of its spin, and how this structure is modified when the proton is inside a nucleus

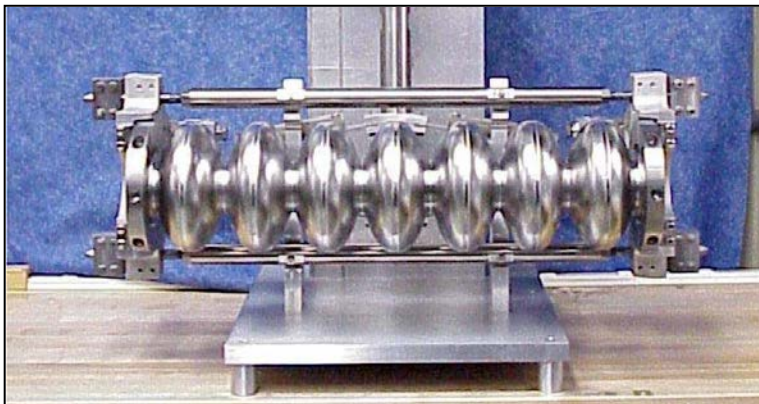

Main Elements of the 12 GeV CEBAF Upgrade

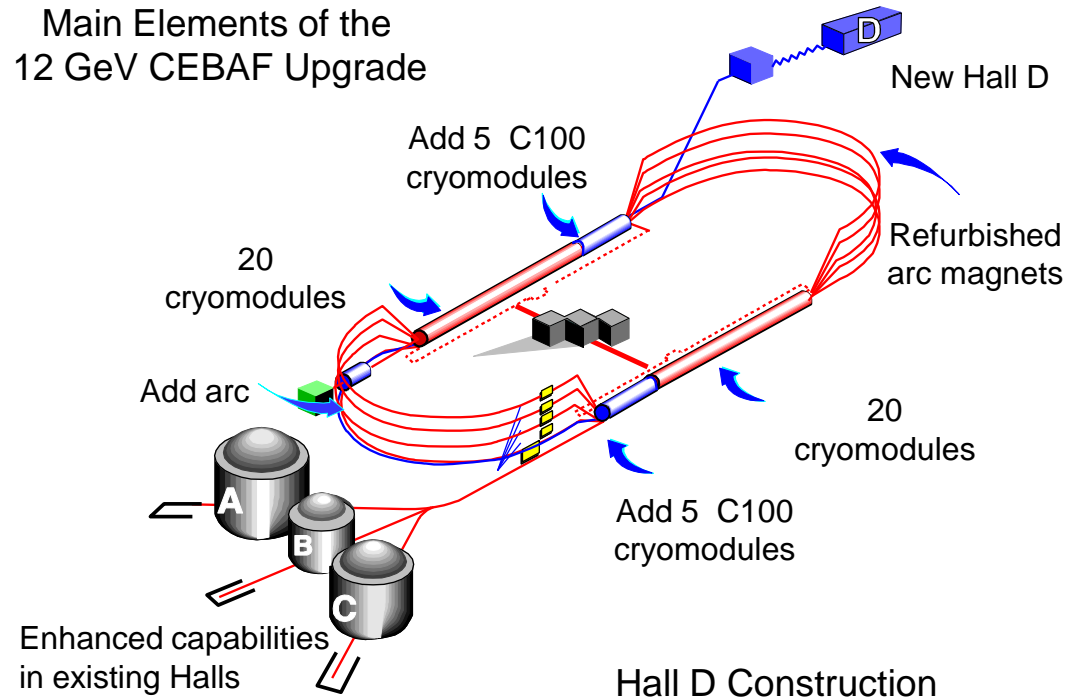

A photograph of one of the superconducting radio frequency (SRF) cavities developed and constructed at Thomas Jefferson National Laboratory (TJNAF) to increase the energy of the CEBAF electron beam. There are eight such cavities in each of the ten C100 cryomodules installed as part of the 12 GeV CEBAF Upgrade (above schematic)

Preparations for Construction of Facility for Rare Isotope Beams

Existing National Superconducting Cyclotron Laboratory



New FRIB Linear Accelerator

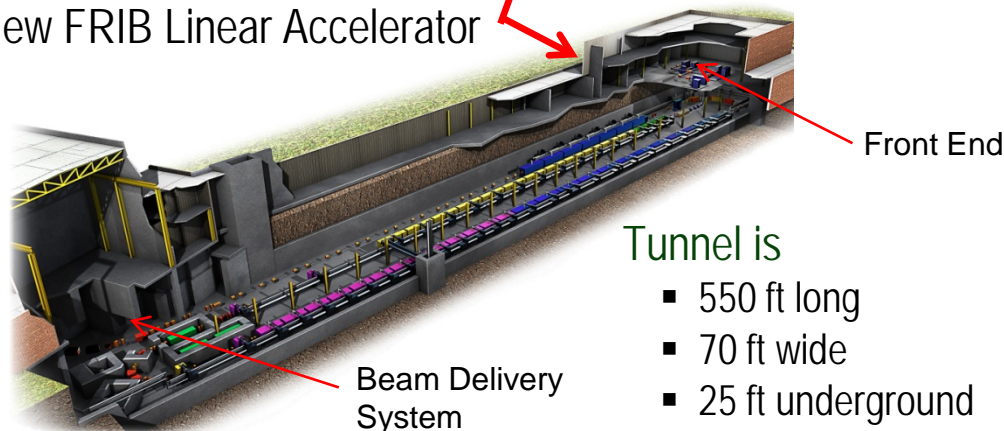

Tunnel is

- 550 ft long
- 70 ft wide
- 25 ft underground

FRIB will increase the number of isotopes with known properties from ~2,000 observed over the last century to ~5,000 and will provide world-leading capabilities for research on:

Nuclear Structure

- The ultimate limits of existence for nuclei
- Nuclei which have neutron skins
- The synthesis of super heavy elements

Nuclear Astrophysics

- The origin of the heavy elements and explosive nucleo-synthesis
- Composition of neutron star crusts

Fundamental Symmetries

- Tests of fundamental symmetries, Atomic EDMs, Weak Charge

This research will provide the basis for a model of nuclei and how they interact.

Neutrino-less Double Beta Decay

Grand challenge question: Is the neutrino its own anti-particle?

- An R&D effort on the Majorana Demonstrator (MJD) will help establish the feasibility of a tonne-scale ^{76}Ge neutrino-less double beta-decay experiment
- The MJD technology demonstration is planned prior to a down-select with the German GERDA experiment between competing Ge technologies and a planned collaboration together
- MJD is on track with electroforming and with procurement and processing of enriched Ge
- MJD plans to go underground with natural Ge in a prototype cryostat at the Sanford Laboratory (South Dakota) in about March 2012
- The technology and the location of a future, international tonne-scale experiment is TBD based on the best value and the best science capability

Germanium detector and the cryostat for the Majorana Demonstrator (MJD 40-kg ultra-clean Ge detector).

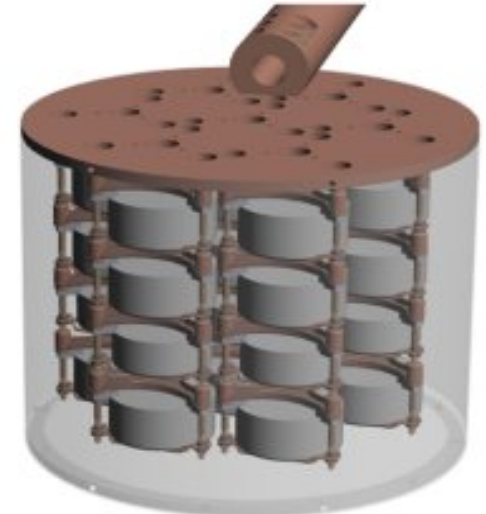
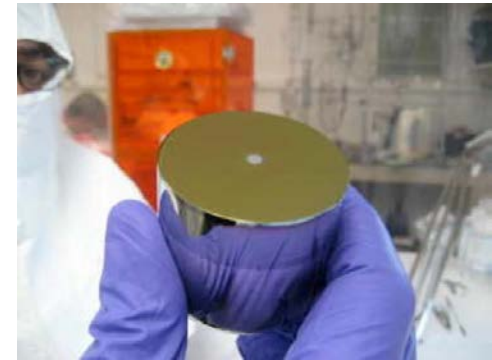

An SC-NNSA Joint Workshop on Isotope Supply and Demand

A New Era of Communication and Coordination on Isotopes by Federal Agencies

1st Workshop on Isotope Federal Supply and Demand, Jan 11-12, 2012

- Armed Forces Radiobiology Research Institute
- Central Intelligence Agency
- Defense Threat Reduction Agency
- Department of Agriculture
- DOE/Office of Environmental Management
- DOE/Office of Intelligence
- DOE/New Brunswick Laboratory
- DOE/Nuclear Energy
- DOE/National Nuclear Security Administration
- DOE/Office of Science
- DOE/Savannah River Operations Office
- Department of Health and Human Services
- Department of Homeland Security
- Department of Transportation
- Environmental Protection Agency
- Federal Bureau of Investigation
- National Aeronautics and Space Administration
- National Institutes of Health
- National Institute of Standards and Technology
- National Science Foundation
- National Security Staff
- Office of the Assistant Secretary of Defense



Homeland Security



U.S. DEPARTMENT OF ENERGY

Office of Science



SAVANNAH RIVER OPERATIONS OFFICE



U.S. DEPARTMENT OF ENERGY

Office of Science

Isotopes and Radioisotopes in Short Supply Provided at Full Cost Recovery by the Office of Science to Support U.S. Needs and Industrial Competitiveness

Some key isotopes and radioisotopes and the companies that use them

Strontium-82, Rubidium-82	Imaging / Diagnostic cardiology
Germanium-68, Gallium-68	Calibration / PET scan imaging
Californium-252	Oil and gas exploration and manufacturing controls
Selenium-75	Radiography / Quality control
Actinium-225, Yttrium-90, Rhenium 188	Cancer / Infectious disease treatment
Nickel-63	Explosives detection at airports
Gadolinium-160, Neodymium-160	Tracers and contrast agents for biological agents
Iron-57, Barium-135	Standard sources for mass spectroscopy
Sulfur-34	Environmental monitoring
Rubidium-87	Atomic frequency / GPS applications
Lithium-6, Helium-3	Detection of Special Nuclear Materials
Samarium-154	Solar energy / transportation applications



End of slides



Science for Clean Energy: Nanoscale to Mesoscale Sciences

- Developing the next generation of materials, chemicals, and game-changing processes—understanding structure, properties, and function from atoms and molecules, through the nanoscale, and to the mesoscale.
- Research will enable science-based chemical and materials design and manufacturing in, for example:
 - direct conversion of solar energy to fuels
 - generation of electricity from clean energy sources
 - storage and transmission of electrical energy
 - carbon capture, utilization, and sequestration
 - the efficient use of energy
- Collaboration with the Office of Energy Efficiency and Renewable Energy will accelerate the transition of scientific discoveries into prototype clean energy technologies.

Will ask BES for an alternate set of images—nano to meso to manufacturability

Program/Science Accomplishments

- **HEP:** Saul Perlmutter, UCB and LBNL, is the Physics Nobel Laureate, 2011, for the discovery of the accelerating expansion of the Universe through observations of distant supernovae
- **ASCR:** SciDAC-NNSA calculation provided a description of neutron-tritium scattering that enabled NIF fuel assembly decisions, impossible using physical testing.
- **BES:** LCLS “self-seeding” technique uses an x-ray pulse from the LCLS as the “seed” – the result is a factor of 40 reduction in energy bandwidth while maintaining the same peak power, increasing signal-to-noise and a more stable beam
- **BER:** A microbe was engineered to synthesize bisabolane, a replacement for diesel transportation fuel, demonstrating design of a biofuel target and production of the fuel with engineered microbes
- **NP:** Data from RHIC on the heaviest anti-nucleus ever observed were highlighted as #3 in Discover Magazine’s Top 10 Physics/Math Stories for 2011: “Helium’s Anti-Matter Twin Created”
- **FES:** xxx

Inexpensive Solar Cell Absorbs Nearly All Available Light

From Fundamental Research to Rooftop Applications

Basic Science
Energy Frontier Research Center

Manufacturing/
Commercialization

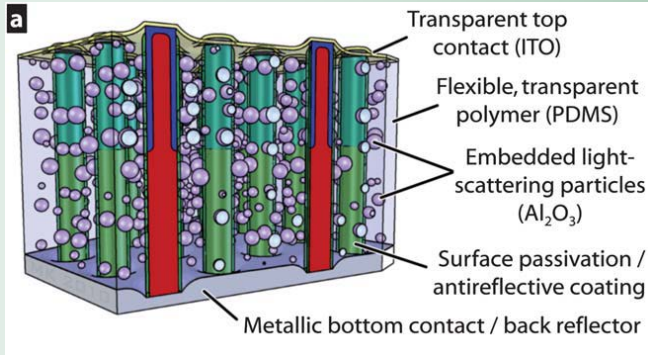

Light absorbing nanowires surrounded by polymer that contains Al_2O_3 scattering particles



Sunlight can be efficiently collected and redirected: Materials that occupy as little as 2% of the solar cell volume absorb up to 85% of the available sunlight

Caelux, a start-up company funded by the DOE PV Solar Incubator Program, develops solar cell designs and flexible manufacturing process that minimize the use of semiconducting material.

This invention has the potential to significantly improve device efficiency while dramatically reducing production costs.

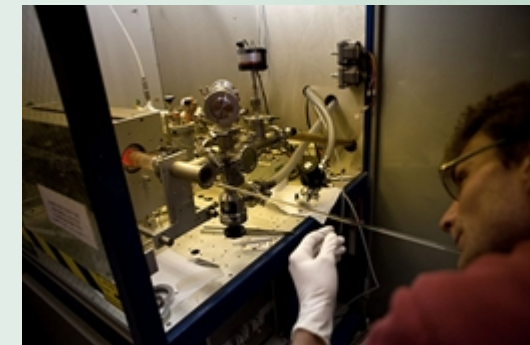
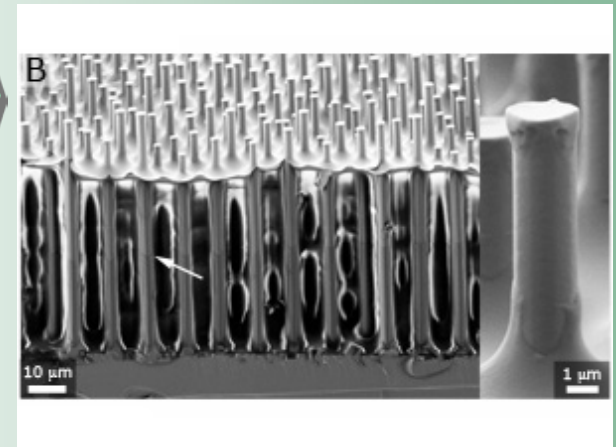

Breakthrough Award from *Popular Mechanics* 2010

Superplastic Forming of Aluminum

Basic Science Reduces Vehicle Weight, Improves Fuel Economy, Reduces Emissions

Basic Science

Fundamental research provided mechanistic understanding of the aluminum alloy microstructure and the superplastic deformation.

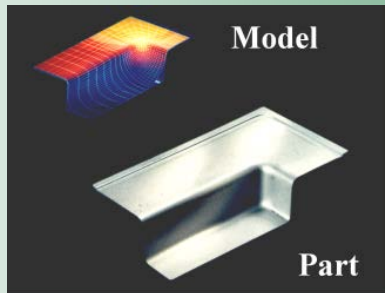
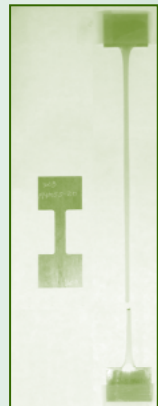
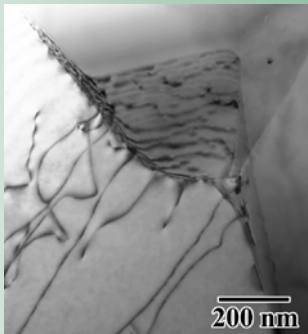

Applied R&D

Refined superplastic forming and optimized alloys to produce high quality, affordable, mass-produced aluminum parts.

PNNL worked with Kaiser Aluminum to develop new alloys based on the basic understanding of grain boundary sliding and recrystallization

Transportation Technology, Lab Technology Research Program (DOE), and NASA funded this applied research. Partnership with MARC Analysis to advance finite element modeling.

Manufacturing/Commercialization

General Motors further developed the technology and reduced the cycle time. Used in Cadillac STS, Oldsmobile Aurora, and Chevy Malibu Maxx.



Kaiser Aluminum -- new aluminum alloy.

Superconducting MgB₂ Wires

From Discovery to Commercialization within a Decade

Basic Science

Developed high-purity synthesis

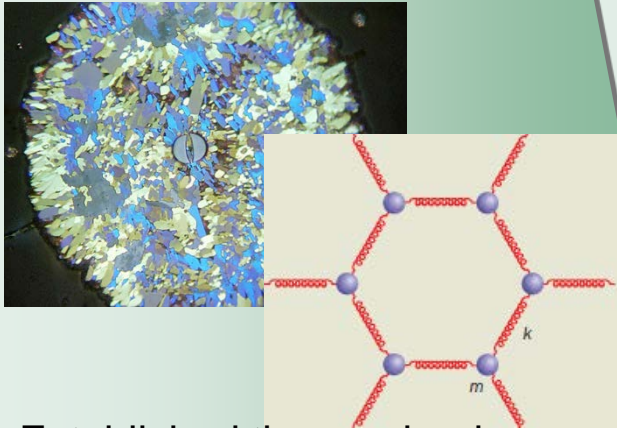

Established the mechanism for superconductivity

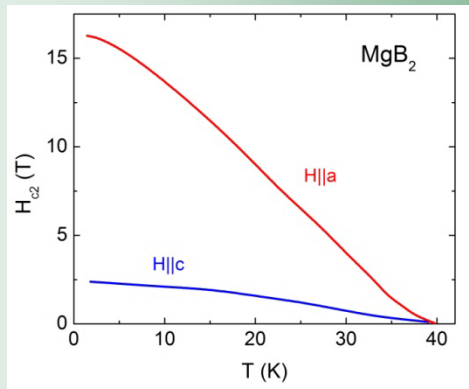

Delineated the basic physics

Applied R&D SBIR

Improved properties through chemistry optimization

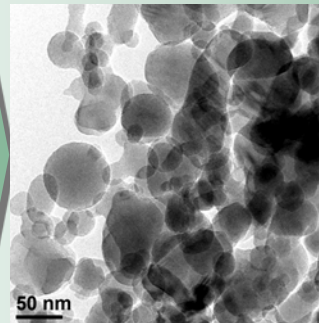
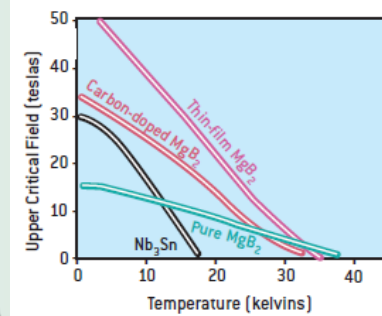

Developed production scale processes

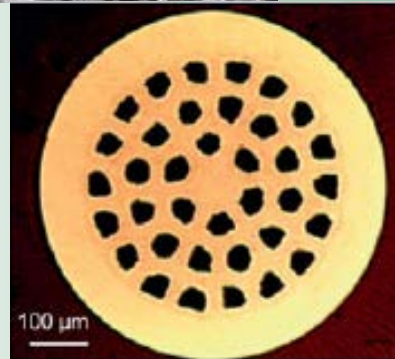

Fabricated industrial wires

Manufacturing/ Commercialization

SPECIALTY MATERIALS, INC.

Manufacturers of Boron and SCS Silicon Carbide Fibers

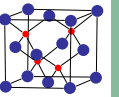

Design and construct commercial magnets

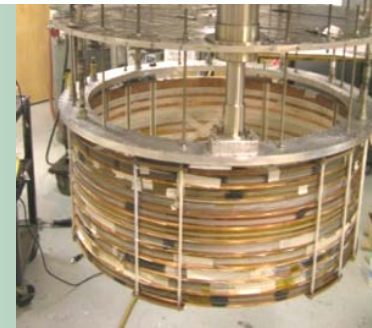

ASG Superconductors

MgB₂ superconducting wires allows for open-MRI systems



U.S. DEPARTMENT OF
ENERGY

Office of
Science

Program Details



Office of the Director
William Brinkman

Deputy Director
for Field Operations
Joseph McBrearty
Associate Deputy – *Stephanie Short*

- AMSO
Baebler
- ASO
Livengood
- BSO
Richards
- BHSO
Holland
- FSO
Weis
- OSO
Moore
- PSO
Dikeakos
- PNSO
Snyder
- SSO
Golan
- TJSO
Arango

Chicago
Office
Purucker

SC
Integrated
Support
Center

Oak Ridge
Office
Eschenberg (A)

Office of LPE
Streit

Office of SSI
Jones

Deputy Director
for Science Programs
Patricia Dehmer
Staff

ASCR
Hitchcock

BES
Kung

BER
Weatherwax

FES
Synakowski

HEP
Siegrist

NP
Hallman

WDTS
Dehmer (A)

Project Assessment
Lehman

SBIR/STTR
Programs Office
Oliver

Deputy Director
for Resource Management
Jeffrey Salmon

Budget
Klausing

Grants
& Contracts Support
Shariati

SCPD & Analysis
Kelley

OSTI
Warnick

Business Policy
& Operations
Phan

SC
Communications
and Public Affairs
Hatchett

Human Resources
and Administration
Mays

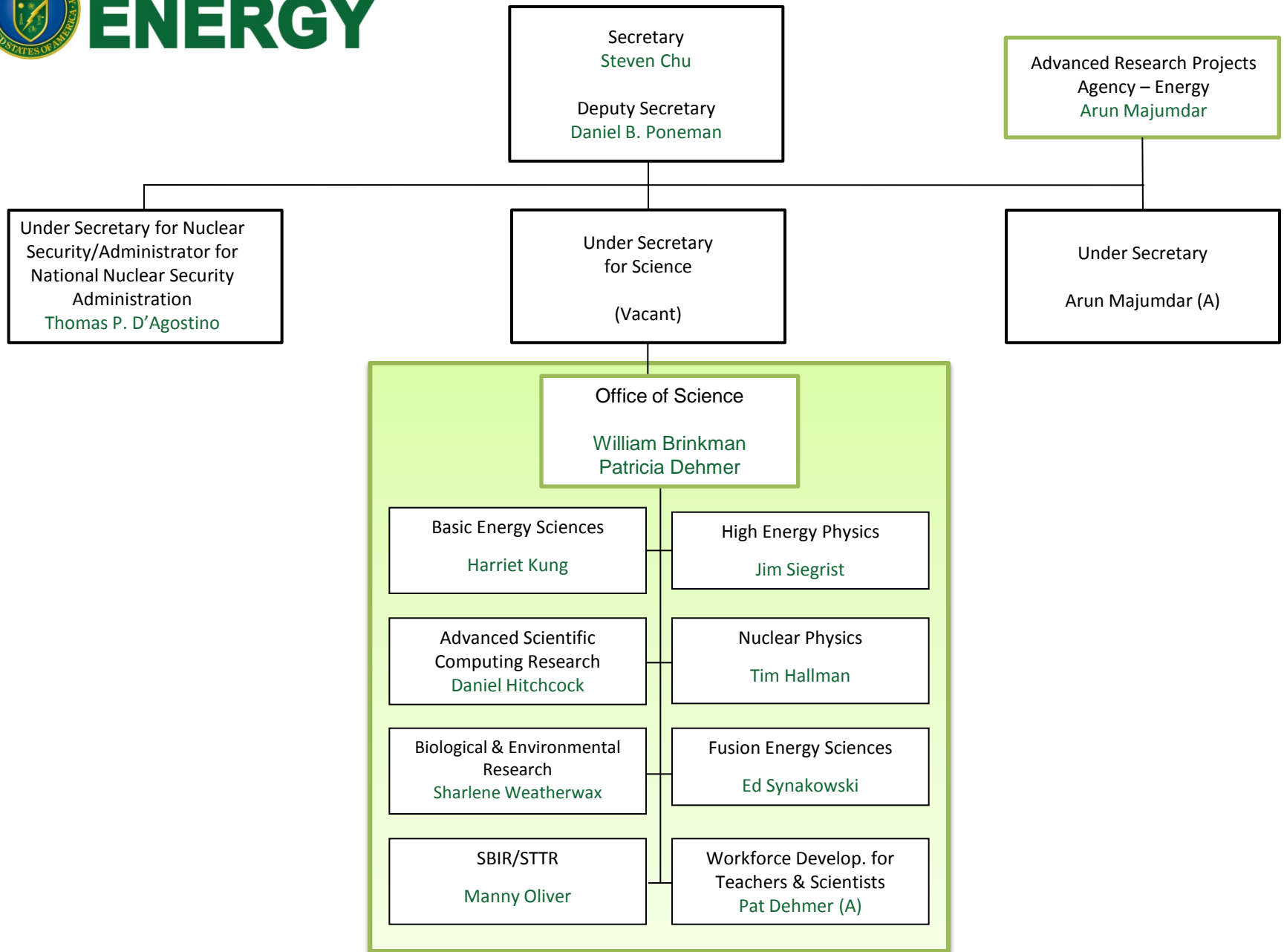

Advanced Scientific Computing Research

Delivering world leading computational and networking capabilities to extend the frontiers of science and technology

The Scientific Challenges:

- Deliver next-generation scientific and energy applications on multi-petaflop computers.
- Discover, develop, and deploy exascale computing and networking capabilities.
- Partner with U.S. industry to develop the next generation computing hardware and tools for science.
- Discover new applied mathematics, computer science, and networking tools for the ultra-low power, multicore-computing future and data-intensive science.
- Provide technological innovations for U.S. leadership in Information Technology to advance competitiveness.

FY 2013 Highlights:

- Co-design centers to deliver next generation scientific applications.
- Investments with U.S. industry to address critical challenges on the path to exascale.
- Operation of a 10 petaflop low-power IBM Blue Gene/Q at the Argonne Leadership Computing Facility and installation and early science access to a 10-petaflop, hybrid, multi-core computer at the Oak Ridge Leadership Computing Facility.
- Research efforts across the portfolio in support of data-intensive science including the massive data produced by Scientific User Facilities.

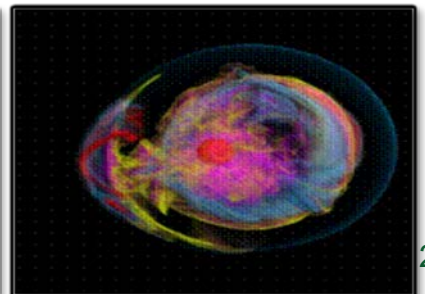
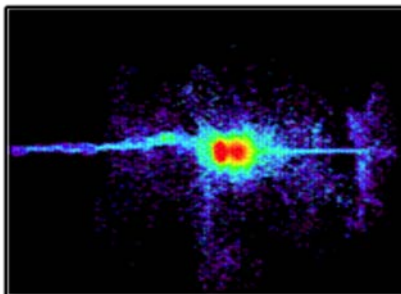
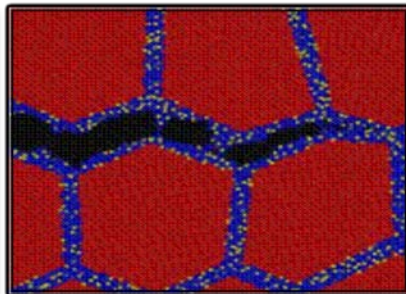
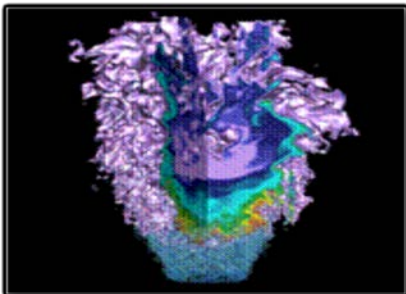

Leadership Computing Facilities Support Scientific Research for a Clean Energy Future



Argonne Leadership Computing Facility



Oak Ridge Leadership Computing Facility

In FY 2012, the Argonne LCF will be upgraded with a 10 petaflop IBM Blue Gene/Q. The Oak Ridge LCF will continue site preparations for a system expected in FY 2013 that will be 5-10 times more capable than the Cray XT-5.

- The Cray XK6 ("Jaguar") at ORNL and the IBM Blue Gene/Q ("Mira") at ANL will provide ~3.5 billion processor hours in FY 2013.
- Peer reviewed projects are chosen to advance science, speed innovation, and strengthen industrial competitiveness.
- Demand for these machines has grown each year, requiring upgrades of both.
- Among the topics in FY 2012:
 - Advancing materials for lithium air batteries, solar cells, and superconductors
 - Exploring carbon sequestration
 - Improving combustion in fuel-efficient, near-zero-emissions systems
 - Understanding how turbulence affects the efficiency of aircraft and other transportation systems
 - Designing next-generation nuclear reactors and fuels and extending the life of aging reactors
 - Developing fusion energy systems

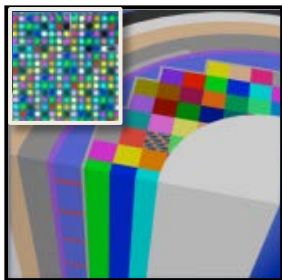

Nuclear Reactor Simulation

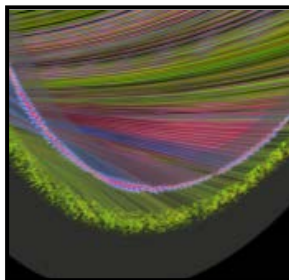

Fusion Plasmas

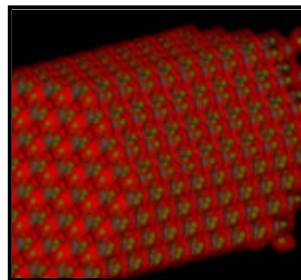

Nanoscale Science

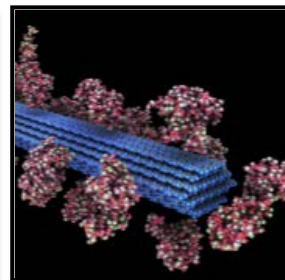

Biofuels

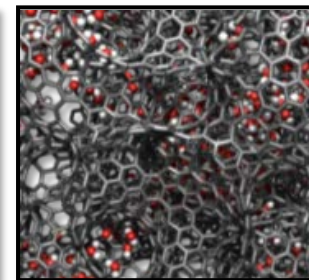

Energy Storage Materials

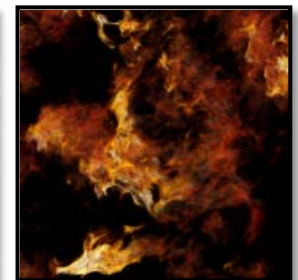

Turbulence



Leadership Computing Facilities

INCITE Demand Outpaces Supply

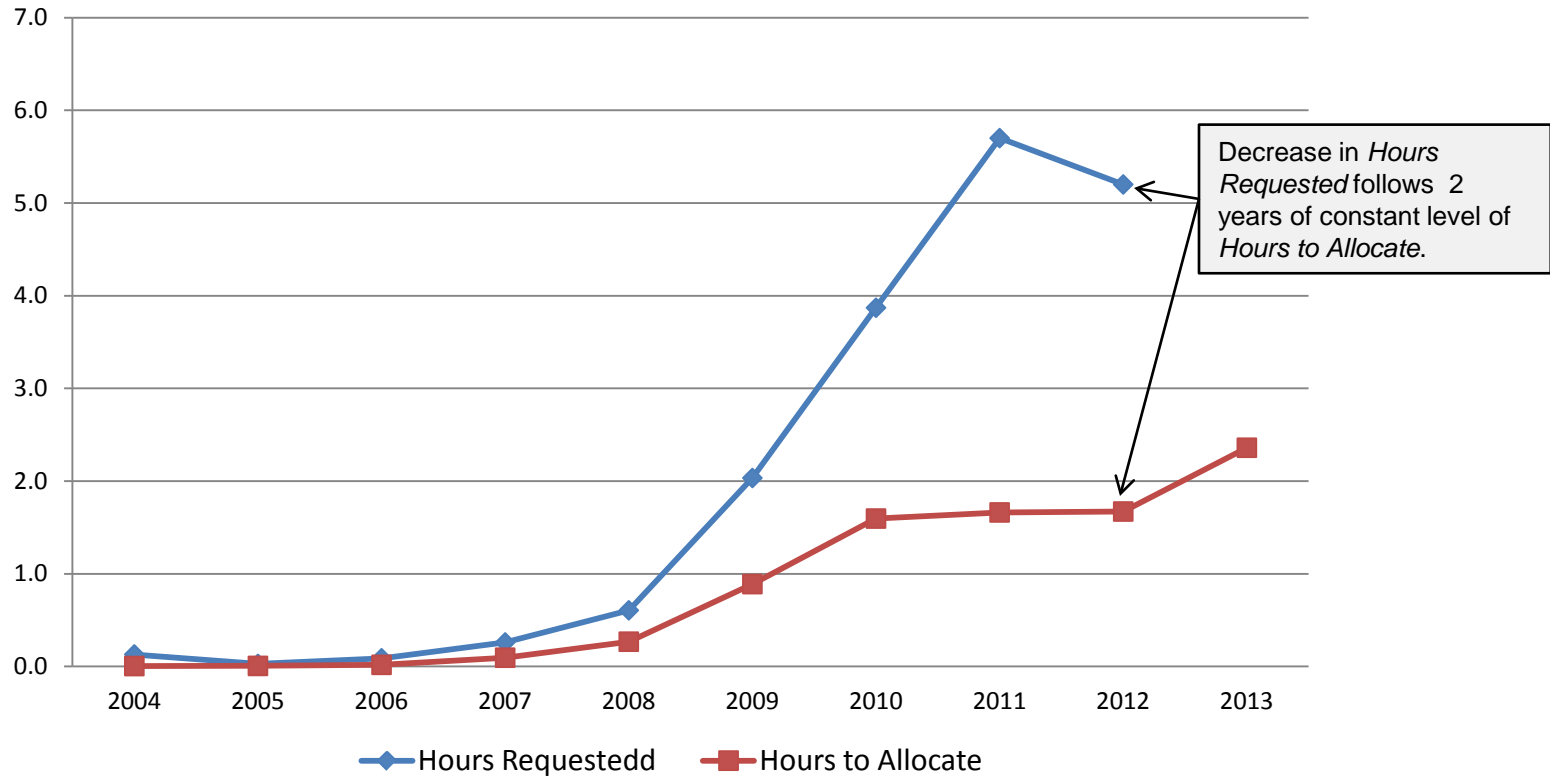

Argonne Leadership Computing Facility

Today 557 Teraflops, 1.2 MW: CY 2012 10 Petaflops, 5 MW

Oak Ridge Leadership Computing Facility

Today 2.3 Petaflops, 6 MW: CY 2012 10-20 Petaflops 7-10 MW



INCITE Computing Contributes to U.S. Competitiveness and Clean Energy



- **GE** determined the effects of unsteady flow interactions between blade rows on the efficiency of turbines.
 - Provided engineers with the analytical tools to extract greater design efficiency and fuel savings.
 - Results provided substantial ROI justification for GE to purchase its own Cray supercomputer



- **Ramgen** used computational fluid dynamics with shock compression to expedite design-cycle analysis.
 - Accelerated the development of the CO₂ compressor allowing Ramgen to go from computer design and testing to cutting a Titanium prototype in 2 months.

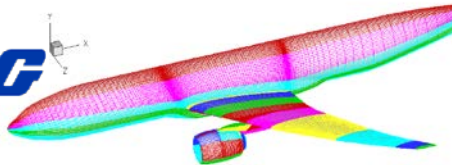

- **Boeing** demonstrated the effectiveness and accuracy of computational fluid dynamics simulation tools and used them in designing their next generation of aircraft.
 - Significantly reduced the need for prototyping and wind tunnel testing.



- **GM** accelerated materials research by at least a year to help meet fuel economy and emissions standards.
 - A prototype thermoelectric generator in a Chevy Suburban generated up to 5% improvement in fuel economy.

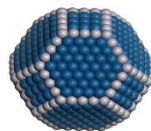

- **United Technologies** studies of nickel and platinum are demonstrating that the less expensive nickel can be used as a catalyst to produce hydrogen.

Ten Times the Bandwidth Over Existing Fiber

Nationwide rollout of 100 gigabit per wavelength service on ESnet

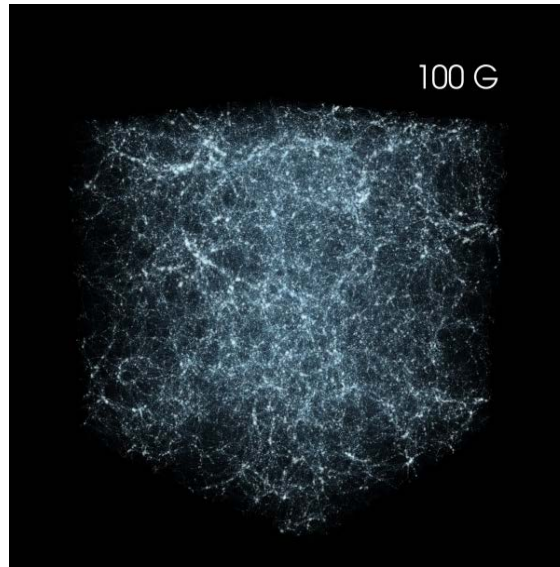
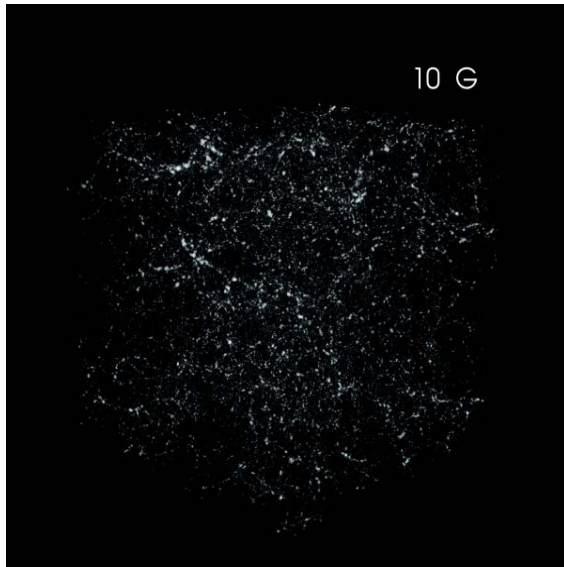

Model of the early universe.
~13.7 billion years ago, the Universe was near homogenous. Today, the modern Universe is rich in structures that include galaxies, clusters of gravitationally bound galaxies, galaxy super-structures called "walls" that span hundreds of millions of light-years, and the relatively empty spaces between superstructures, called voids.

See the difference 100G can make

Simulation, performed on 4,096 cores of NERSC's Cray XE6 "Hopper" system produced over 5 terabytes of data that was transferred to the Supercomputing 2011 exhibit floor in Seattle, Washington, in near real-time on ESnet's new 100 gigabit-per-second (Gbps) network. For comparison, a simulation using a 10 Gbps network connection was displayed on a complementary screen to show the difference in quality that an order of magnitude difference in bandwidth can make.

Investments for Exascale Computing

Addressing Critical Challenges to Deliver Predictive Science and Engineering

Challenges of Exascale

DOE must invest in partnerships and research to address the challenges of emerging hardware to maintain our world-leading position.

- Reduce power requirements by a factor of 10.
- Improve reliability so that hardware operates effectively through component failures.
- Develop tools and techniques to make these advanced systems easier to use.

Broad Impacts

Computation and simulation advance knowledge in science, energy, and national security; numerous S&T communities and Federal Advisory groups have demonstrated the need for computing power 1,000 times greater than we have today.

The program will:

Advance all DOE missions

- DOE missions include challenges for which experiments are too risky or expensive to pursue. Exascale capabilities will deliver an new level of precision and predictability to these efforts.

Drive innovation

- Achieving the power efficiency, reliability, and programmability goals essential for exascale will have enormous impact on business information technology, scientific computing, and engineering design at all scales.

Build on our successes

- DOE is the U.S. leader in delivering extreme scale science and engineering applications on state-of-the-art hardware.

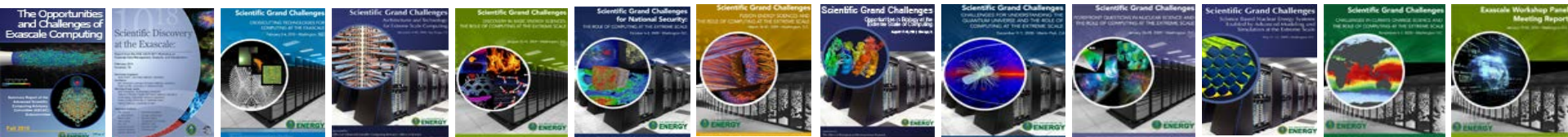

Summary of the Challenges for Exascale Computing

Energy Utilization

- An Exascale machine built with today's technology would take more than a gigawatt of electricity or the output of a nuclear reactor.
- Memory and data movement are the key energy hogs.

Parallelism in the Extreme (aka Concurrency)

- Billions of regular processors and specialized processors will need to work together and share data seamlessly while minimizing data movement.

Fault Tolerance

- An exascale machine built with today's technology would have a mean time to failure of a few minutes.

Positioning Computing for a Low-power Future

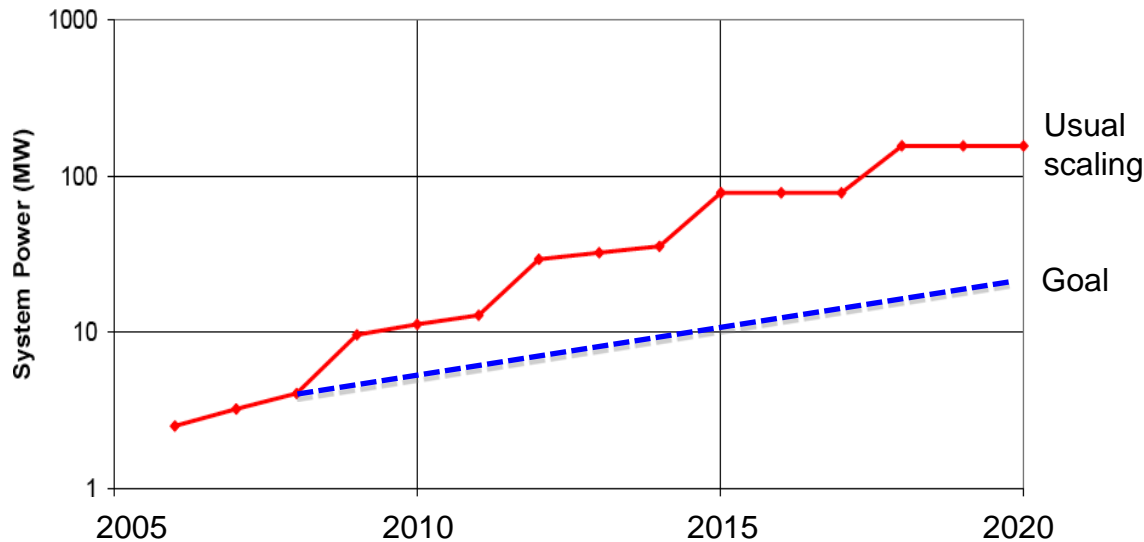

- At \$1M per MW, energy costs are substantial and key driver
- Today, 1 petaflop uses average of 3 MW
- 1 exaflop with “usual” scaling uses 200 MW
- GOAL: 1 exaflop using 20 MW

DOE investment strategies:

- Couple applications and hardware design/development using Co-Design activities
- Create new programming models and operating system strategy
- Develop new software tools and algorithms
- Accelerate development of critical technologies such as stacked memory



Example: New Turbo Compressors Reduce the Cost of Carbon Capture and Sequestration

Jaguar (OLCF) helped Ramgen to go from computer design and testing to cutting Titanium in two months

- **CO₂ compressors are a large fraction of the cost of Carbon Capture and Sequestration (CCS)**
- **Ramgen Power Systems is developing shock compression turbo machinery to reduce CCS costs**
 - A complementary goal for Ramgen's innovations is lower cost, more efficient gas turbines for electricity generation
- **Ramgen has significantly advanced its shock wave based compression aerodynamic design process**
 - Observed designs that exhibit valuable new characteristics, only possible with OLCF's Jaguar supercomputer
- **A new workflow paradigm shortens a more comprehensive design cycle for the compressors**

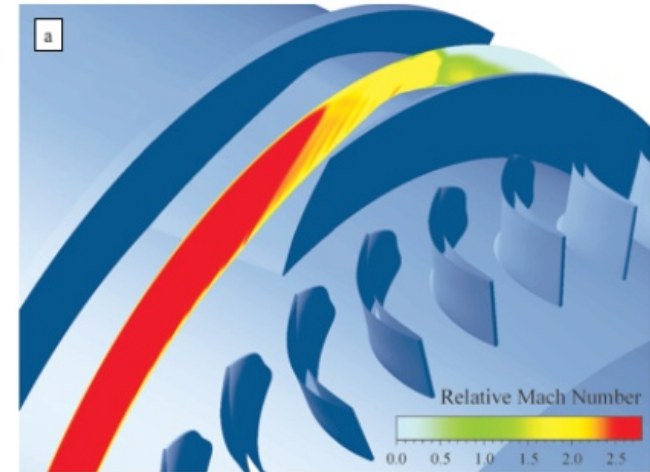

Computational Fluid Dynamics model of Rampressor-2 inlet guide vane row and rotor

“Ramgen Power Systems would like to thank the Oak Ridge Leadership Computing Facility for helping us utilize Jaguar to the fullest potential, and drive innovations in a technology that will result in highly important products for the United States and the world.”

- Allan Grosvenor, Ramgen Power Systems

Example: Design of Fuel Efficient, Low Noise Jet Engines

Results provided substantial ROI justification for GE to purchase its own supercomputer

- **General Electric ran their largest-ever computational fluid dynamics (CFD) calculation to advance study of turbomachinery**
- **Studied for the first time unsteady flow characteristics in turbomachinery. This permitted comparative study of traditional turbine CFD analysis (steady flow) vs. unsteady flow analysis with and without mid-frame strut for a low pressure turbine**
- **3D simulations explored time dependence**
- **Identified efficiency shifts in each stage**
- **Discovered new insight into the behavior of secondary flows: vortical, high entropy flows near the hub and casing**

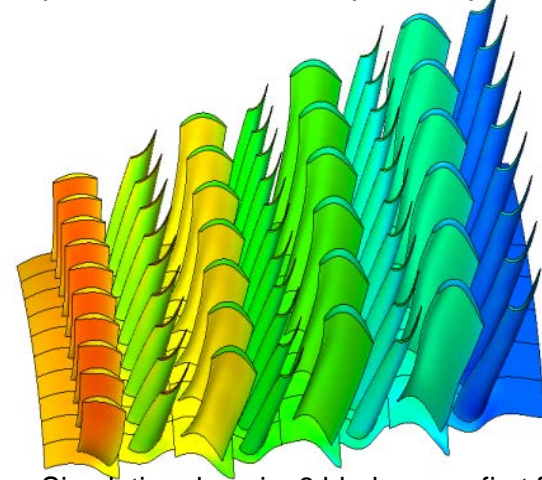

Simulation domain: 8 blade rows, first four stages of a 7-stage low pressure turbine: 200M grid cells, 180K iterations



Example: Quieter Planes



Landing gear of Boeing 777

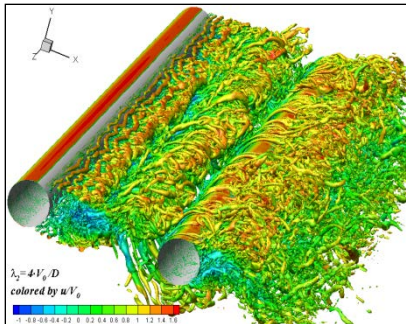

Tandem cylinder used for V&V

- Boeing is using ALCF to simulate the noise created by aircraft landing gear. The noise is caused by two cylinders.
- Boeing is using ALCF to simulate the noise created by aircraft landing gear. The noise is caused by two cylinders.
- The simulations are being carried out on eight 192 nodes (i.e. 32,768 cores) of the Blue Gene/P. The code used is the multi-purpose Computational Fluid Dynamics code NTS. It allows Delayed Detached-Eddy Simulation and Improved Delayed Detached-Eddy Simulations to be compared, to each other and to experimental data.

See notes page for backgrounder from the ALCF website. This example may be too great a stretch; I don't recommend using it.

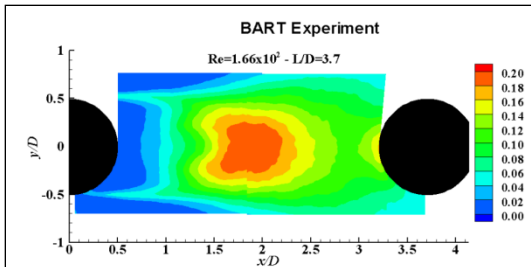

Experiment used as baseline

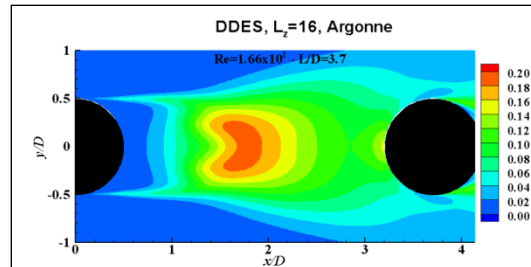

DDES method run at ALCF

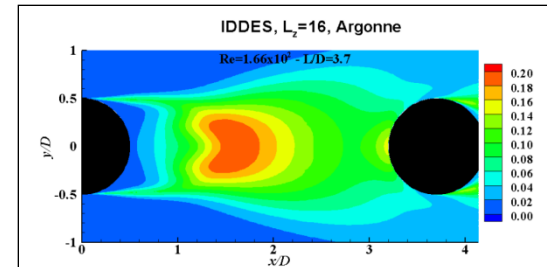

IDDES method run at ALCF

Basic Energy Sciences

Understanding, predicting, and ultimately controlling matter and energy flow at the electronic, atomic, and molecular levels

The Scientific Challenges:

- Synthesize, atom by atom, new forms of matter with tailored properties, including nano-scale objects.
- Direct and control matter and energy flow in materials and chemical assemblies over multiple length and time scales.
- Explore materials functionalities and their connections to atomic, molecular, and electronic structures.
- Explore basic research to achieve transformational discoveries for energy technologies.

FY 2013 Highlights:

- Science for clean energy
 - Science-based chemical and materials discovery to enable manufacturing innovations
 - R&D for next-generation clean energy applications jointly funded with EERE
- Materials and chemistry by design: discovery grounded in theory and modeling
- National Synchrotron Light Source-II construction and early operations
- User facilities at near optimum operations; facility upgrades and enhancements
 - LCLS expansion (LCLS-II); NSLS-II EXperimental Tools (NEXT); APS Upgrade (APS-U)

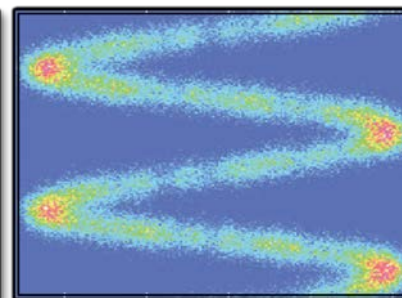
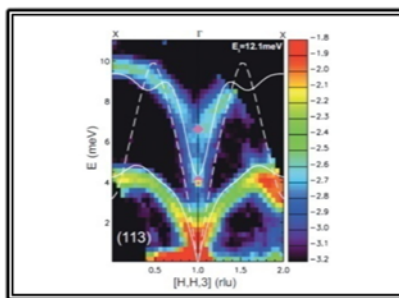
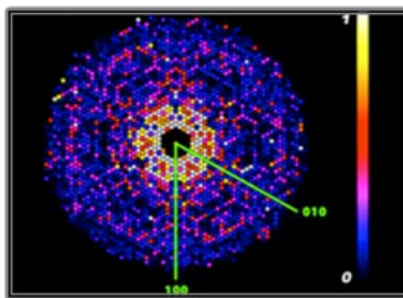
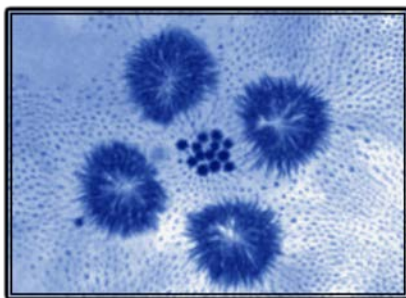

Jointly Funded R&D for Clean Energy

R&D jointly funded by the Office of Science (SC) and the Office of Energy Efficiency and Renewable Energy (EERE) will focus on a clean energy agenda (\$35M in each program).

- **EERE Strategic Programs.** \$25M for R&D to accelerate the transition of novel scientific discoveries into innovative, clean energy technologies. This funding is to be prioritized for university, laboratory, and small business competitive R&D awards to study underlying physical challenges related to clean energy technologies and to design and test next-generation clean energy devices. A further \$10M for joint solicitations is within individual program allocations in EERE for improved coordination of energy-related research across the Department.
- **SC Basic Energy Sciences.** Equivalent levels of funding will support the fundamental science portions of the joint R&D to enable discoveries for innovative clean energy technologies. The SC effort will leverage existing investments in clean energy sciences at Energy Frontier Research Centers and at SC user facilities, such as light sources and Nanoscale Science Research Centers.

Materials and Chemistry by Design

Accelerating Discovery for Global Competitive

Materials by Design
Example 1 from BES

- Research to establish design rules to launch an era of predictive modeling, changing the paradigm of materials discovery to rational design.
 - New software tools and data standards to catalyze a fully integrated approach from material discovery to applications
- Discovery of new materials has been the engine driving science frontiers and fueling technology innovations. Research would utilize the powerful suite of tools for materials synthesis, characterization, and simulation at DOE's world-leading user facilities
- Integrated teams to focus on key scientific knowledge gap to develop new theoretical models
 - Long-term: realization in reusable and broadly-disseminated software
 - Collection of validated experimental and modeling data for broader community use

Prediction

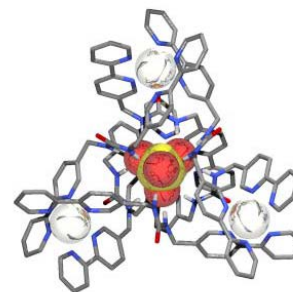
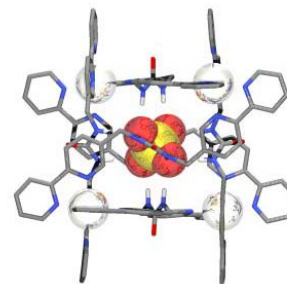

Validation X-Ray Structure

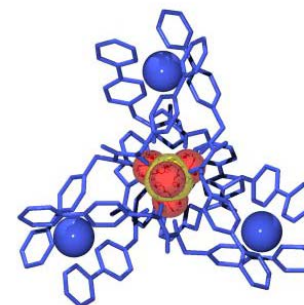
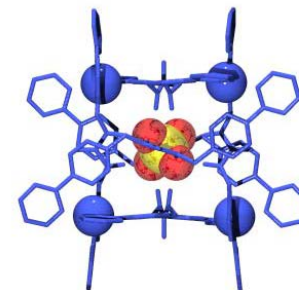

Computer-aided design of self-assembled molecular cage for encapsulation and sequestration of sulfate ion



Materials and Chemistry by Design

Accelerating Discovery for Global Competitive

Materials by Design
Example 2 from BES

- Research to establish design rules to launch an era of predictive modeling, changing the paradigm of materials discovery to rational design.
 - New software tools and data standards to catalyze a fully integrated approach from material discovery to applications
- Discovery of new materials has been the engine driving science frontiers and fueling technology innovations. Research would utilize the powerful suite of tools for materials synthesis, characterization, and simulation at DOE's world-leading user facilities
- Integrated teams to focus on key scientific knowledge gaps to develop new theoretical models
 - Long-term: realization in reusable and broadly-disseminated software
 - Collection of validated experimental and modeling data for broader community use

Prediction: Materials for batteries starting from first principles theory

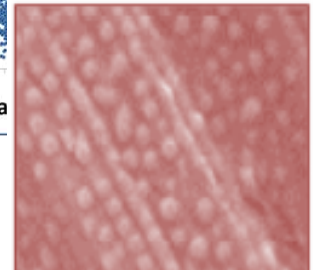
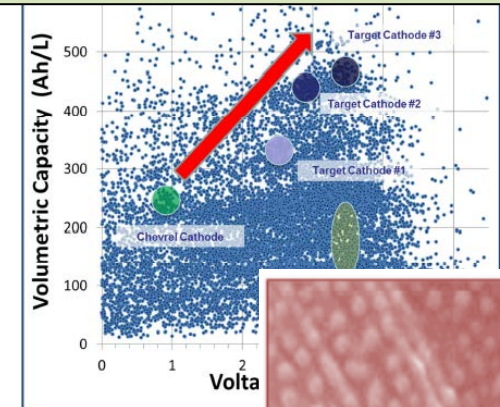

Validation:
Materials fabrication



End Use: Batteries with predicted compositions being commercialized by Pellion Technologies

Materials and Chemistry by Design Accelerating Discovery for Global Competitive

Materials by Design
Example 3 from BES

- Research to establish design rules to launch an era of predictive modeling, changing the paradigm of materials discovery to rational design.
 - New software tools and data standards to catalyze a fully integrated approach from material discovery to applications
- Discovery of new materials has been the engine driving science frontiers and fueling technology innovations. Research would utilize the powerful suite of tools for materials synthesis, characterization, and simulation at DOE's world-leading user facilities
- Integrated teams to focus on key scientific knowledge gaps to develop new theoretical models
 - Long-term: realization in reusable and broadly-disseminated software
 - Collection of validated experimental and modeling data for broader community use

Prediction: New battery materials starting from first principles theory

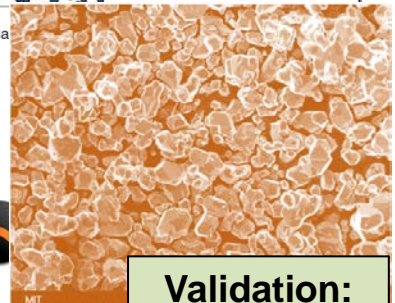
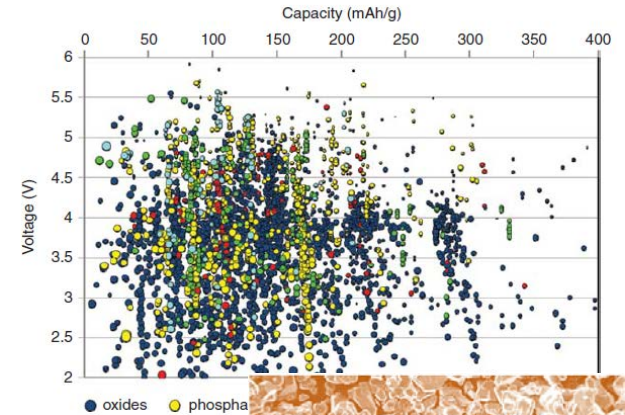

<http://materialsproject.org/>

Validation:
Materials fabrication

End Use: Software on-line for general community use

Topological Insulator Transistor

Towards Efficient Electronics

- Topological insulators insulate on the inside but conduct on the outside – acting like a plastic cable covered with a layer of metal, except that the material is actually the same throughout. The effect is stable against defects.
- An alloy of two previously known topological insulators, Bi_2Te_3 and Sb_2Te_3 , shows improved crystal quality with decreased electron conduction in the bulk of the material and electric charge flowing efficiently only on the surface.
- A transistor, fabricated of this alloy using nanoplates of the material, allows flexible manipulation of the surface electrical properties, essentially switching the charge carriers between negatively charged electrons and positively charged holes.
- This demonstration of a transistor to access and control the electrical properties of topological insulators opens the possibility of faster, more efficient electronic devices for information processing.

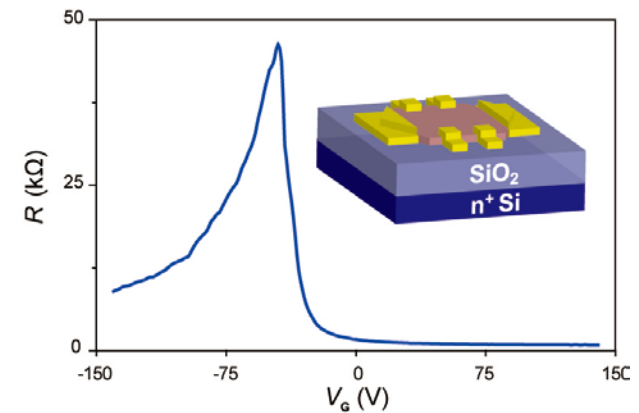
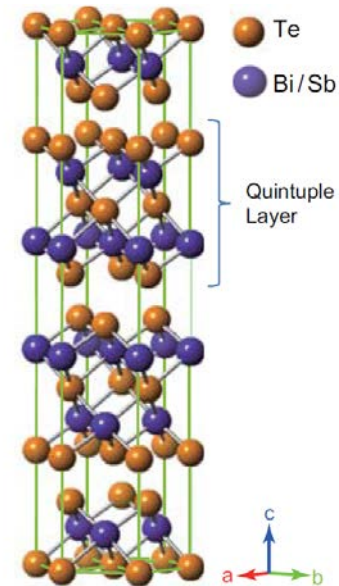

Desheng Kong, Yulin Chen, Judy J. Cha, Qianfan Zhang, James G. Analytis, Keji Lai, Zhongkai Liu, Seung Sae Hong, Kristie J. Koski, Sung-Kwan Mo, Zahid Hussain, Ian R. Fisher, Zhi-Xun Shen and Yi Cui, *Nature Nanotechnology* (2011)

Energy Frontier Research Centers

46 EFRCs in 35 States were launched in Fall 2009

- ~**860** senior investigators and ~**2,000** students, postdoctoral fellows, and technical staff at ~**115** institutions
- > **250** scientific advisory board members from **12** countries and > **35** companies

Impact to date:

- >**1,000** peer-reviewed papers including more than **30** publications in *Science* and *Nature*.
- > **40** patents applications and nearly **50** additional patent/invention disclosures by **28** of the EFRCs.
- at least **3** start-up companies with EFRC contributions

Assessment of progress:

- All EFRCs are undergoing mid-term peer review to assess progress towards goals and plans for the next 2 years of R&D.

FY 2013 plans:

- Enhanced integration with DOE Technology programs to ensure implementation of scientific advances

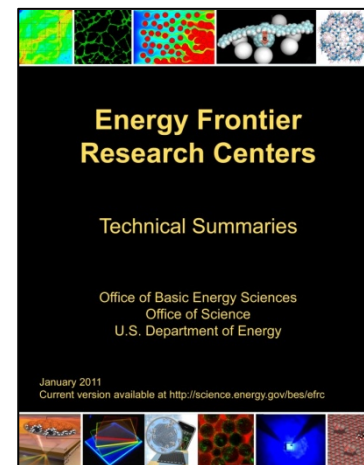

<http://science.energy.gov/bes/efrc/>

Fuels from Sunlight Hub: Project Update

- Space:
 - The Joint Center for Artificial Photosynthesis (JCAP) North (LBNL) occupies 14,000 sq. ft. leased space.
 - JCAP South (Caltech) occupies temporary space; renovation of permanent space complete May 2012.
- Staffing: Staffing ongoing at all levels (senior staff, postdocs, students).
- Equipment: Equipment acquisitions on schedule.
- Output: Several scientific publications and invention disclosures.
- Oversight:
 - BES conducted a management/operations review of JCAP in April, 2011. JCAP on track with no major issues.
 - BES will conduct an onsite scientific and technical review in spring 2012.
- Collaboration:
 - JCAP hosted *Artificial Photosynthesis Futures Meeting* to formulate collaborations with EFRCs and demonstrate new lab capabilities at JCAP North.

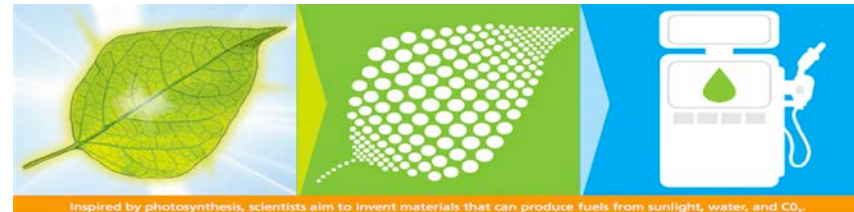

U.S. DEPARTMENT OF
ENERGY

Office of
Science



JCAP Highlight

Photocatalytic Splitting of Water without Bubbles

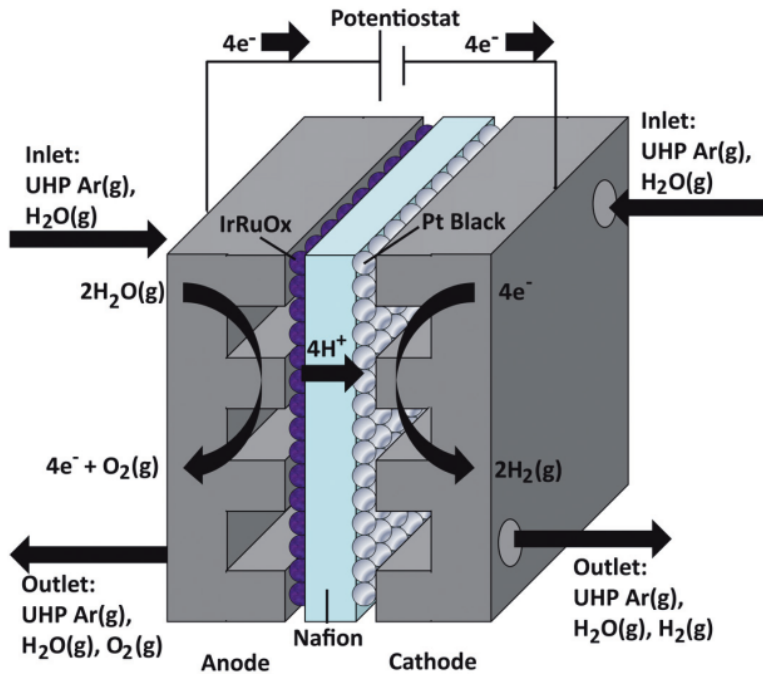

Proton Exchange
Membrane Electrolyzer

- Water splitting uses a light absorber to capture solar energy and a catalyst to drive splitting.
- In liquid water, the H₂ and O₂ bubbles scatter incoming light and slow the transfer of H₂O to the catalyst, lowering the reaction efficiency.

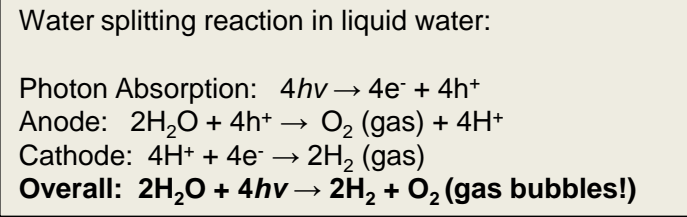

- To eliminate bubble formation, JCAP created a proton exchange membrane (PEM) electrolyzer that generates H₂ and O₂ from **water vapor** instead of liquid water.
- This experiment demonstrates that a solar-powered PEM electrolyzer can operate with only water vapor as input, even at ambient temperatures and in the absence of active heating.



Batteries and Energy Storage Energy Innovation Hub

Transform the Grid and Electrify Transportation

- \$20M in FY 2012 funding was appropriated for the Batteries and Energy Storage Hub
- \$25M is requested in FY 2013 for the second year of funding
- A 5-year award is anticipated in response to the Funding Opportunity Announcement that opened on February 1
 - Letters of Intent are due on March 1
 - Full proposals are due on May 31
 - Decision and award prior to the end of FY 2012
- The Hub will develop electrochemical energy storage systems that safely approach theoretical energy and power densities with very high cycle life – and have the potential for economic and fundamentally new manufacturing
- These are systemic challenges requiring new materials, systems, innovative engineering, and enhanced scientific knowledge
- The Hub will link fundamental science, technology, and end-users, and it will collaborate with relevant BES, Energy Frontier Research Center, ARPA-E EERE, and OE activities



Maintaining World Leadership in Light Sources

National Synchrotron Light Source-II, 67% Complete

Highly optimized x-ray synchrotron:

- exceptional brightness and beam stability
- suite of advanced instruments, optics, and detectors that capitalize on these capabilities

Capabilities:

- ~ 1 nm spatial resolution
- ~ 0.1 meV energy resolution
- single atom sensitivity

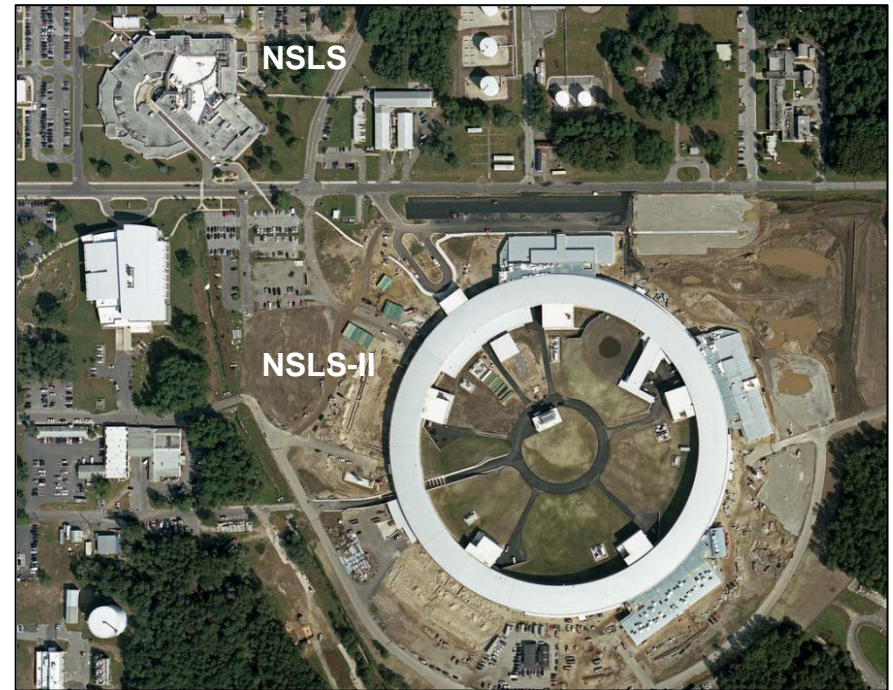

Aug 2005	CD-0, Approve Mission Need	(Complete)
Jul 2007	CD-1, Approve Alternative Selection and Cost Range	(Complete)
Jan 2008	CD-2, Approve Performance Baseline	(Complete)
Jan 2009	CD-3, Approve Start of Construction	(Complete)
Feb 2009	Contract Award for Ring Building	(Complete)
Aug 2009	Contract Award for Storage Ring Magnets	(Complete)
May 2010	Contract Award for Booster System	(Complete)
Mar 2011	1 st Pentant Bldg Beneficial Occ; Start Accel Installation	(Complete)
Feb 2012	Beneficial Occupancy of Experimental Floor	
Apr 2012	Start LINAC Commissioning	
Oct 2012	Start Booster Commissioning	
May 2013	Start Storage Ring Commissioning	
Mar 2014	Projected Early Completion; Ring Available to Beamlines	
Jun 2015	CD-4, Approve Start of Operations	



DOE Light Sources Contribute to American Manufacturing Competitiveness



Revolutionary battery technology leads to a new manufacturing factory in the U.S.

GE researchers used sophisticated scientific capabilities at the NSLS and APS to understand in detail the internal chemistry of an actual commercial battery while charging and discharging in real time. Additional studies of battery cross-sections helped GE engineers to further understand the system to achieve breakthroughs in energy density, charging power, and long cycle life.

Impact:

The new “Durathon™” sodium metal halide battery.

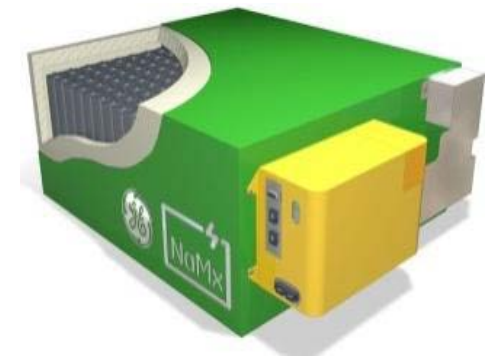

DOE Light Sources Help Design New Drug Treatment for Alzheimer's Disease



Synchrotron Protein Crystallography provides advanced analysis of protein structures in the drug discovery process

Lilly scientists obtain insights on the function of potential drugs by examining the protein structural information using APS beamline data.

Impact:

A potential drug for Alzheimer's disease, the beta-secretase inhibitor, is currently in Phase I clinical testing.



Robotic automation experimental set up for Synchrotron Protein Crystallography



U.S. DEPARTMENT OF
ENERGY

Office of
Science

Fortune 500 Users of BES Scientific Facilities



U.S. DEPARTMENT OF
ENERGY

Office of
Science

Neutron Scattering Facilities

- The Spallation Neutron Source (SNS), the world's most intense neutron source, continues to expand the experimental capabilities for neutron scattering, with significant improvement in operation and user support.
 - 14 instruments in user program
 - 890 users in FY11
- The High Flux Isotope Reactor (HFIR) is upgrading existing instruments and developing new capabilities for neutron scattering; it continues reliable operations for nuclear materials research and isotope production:
 - New detector for GS-SANS
 - New neutron imaging station
 - 470 users in FY11
- The Lujan Center, a pulsed spallation source operating at about 100 kW, supports a target hall constructed by SC and instruments fabricated by SC and NNSA that address the needs of both the basic research community and the NNSA mission of science-based stockpile stewardship.
 - 308 users in FY11

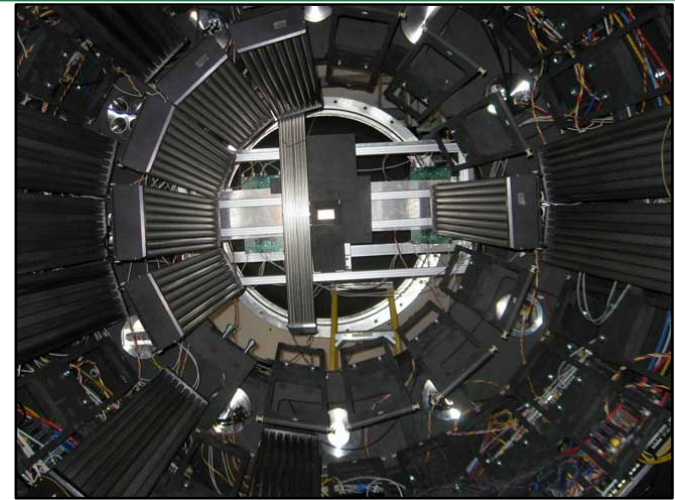

Nanoscale Ordered Materials Diffractometer (NOMAD) Detectors Tank at SNS



Triple-Axis Spectrometer at HFIR

Biological and Environmental Research

Understanding complex biological, climatic, and environmental systems across vast spatial and temporal scales

The Scientific Challenges:

- Understand how genomic information is translated with confidence to redesign microbes, plants or ecosystems for improved carbon storage, contaminant remediation, and sustainable biofuel production
- Understand the roles of Earth's biogeochemical systems (atmosphere, land, oceans, sea ice, subsurface) in determining climate so we can predict climate decades or centuries into the future, information needed to plan for future energy and resource needs.

FY 2013 Highlights:

- Clean energy biodesign on plant and microbial systems through development of new molecular toolkits for systems and synthetic biology research.
- Continue support for the Bioenergy Research Centers, the Joint Genome Institute, the Environmental Molecular Sciences Laboratory, and the Atmospheric Radiation Measurement Climate Research Facility.
- Research and new capabilities to develop comprehensive environmental system models in the Arctic and tropics, regions especially vulnerable to rapid climate change.

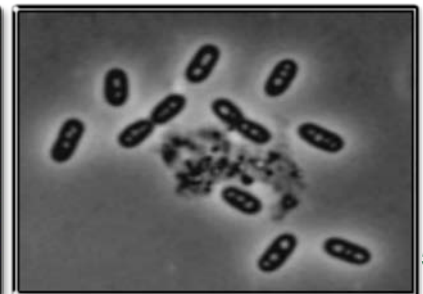
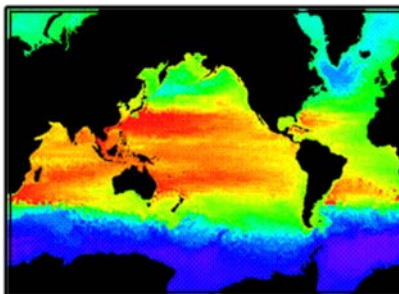
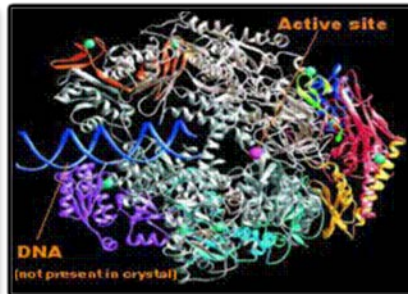
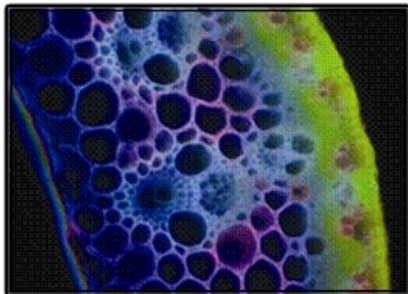

The Bioenergy Research Centers

Accelerating the delivery of basic science to biofuel technologies

Biofuel focused, multi-disciplinary, team-based research

- **BioEnergy Science Center (Oak Ridge National Lab)**
- **Great Lakes Bioenergy Research Center (U. Wisc., Mich. State U.)**
- **Joint BioEnergy Institute (Lawrence Berkeley National Lab)**
- In 4 years of operations:
 - 293 inventions in various stages of the patent process
 - 740 peer-reviewed publications
- Driven by milestones and deliverables, by the end of FY 2012 the BRCs will achieve:
 - Selection of candidate reduced recalcitrance switchgrass and poplar lines for detailed characterization
 - Improved pretreatments of biomass for lignin extraction
 - Initial validation of microbial ethanol production models that integrate transcriptional regulation and metabolic networks
 - Completion of marginal land assessments for sustainability research
 - Selection of candidate plant cell wall synthesis transporters for characterization and modification
 - Demonstration of proof of concept production of drop-in advanced biofuel in a solvent-tolerant microbe



Advancing Energy Technologies through Bioenergy Research



- Identified key lignin biosynthesis genes in switchgrass, providing potential targets for improving switchgrass as a bioenergy crop.
- Used synthetic biology toolkit to construct the first microbes to produce either drop-in biofuels or jet fuel precursors from switchgrass.
- Analyzed field trial data showing that crop selection and soil management practices have a strong impact on greenhouse gas emission and carbon storage, informing sustainable land management strategies for producing bioenergy crop systems.

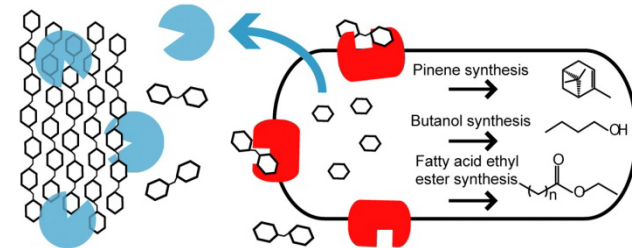
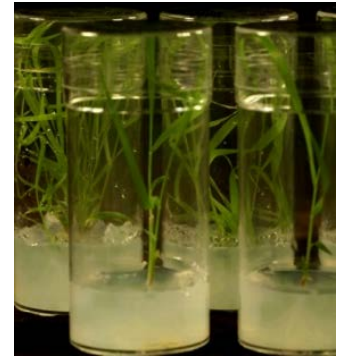

The Joint Genome Institute—Leader in Metagenomics

- Metagenomics is the sequencing of genomes from a community of organisms rather than from a single isolate. Most microbes found in nature exist in complex, inter-dependent communities; metagenomic technologies enable elucidation of their collective function.
- The Joint Genome Institute has been a leader in the development of metagenomic technologies and large-scale genome sequencing for environmental samples
- Microbial carbon cycling in Arctic permafrost
 - Reconstructed whole genome of a novel and abundant, methane-producing microbe from an Arctic permafrost metagenome.
 - Genomic information can inform studies of the effects of warming conditions on the estimated 1.6 trillion metric tons of permafrost sequestered carbon, more than 250 times the amount of greenhouse gas emissions attributed to the United States in 2009.



Next-generation Ecosystem Experiments (NGEE)

- Coupling modeling and process science at landscape scale to enable model representations of critical Earth Systems
- Target systems are chosen that are globally important, climatically sensitive, and understudied/represented in predictive models—Arctic permafrost and Amazonian tropics
 - Warming of permafrost soils will release vast amounts of CO₂ and/or CH₄ to the atmosphere—a strong positive feedback to warming
 - Rainfall stress on Amazonian ecosystems and release of biogenic aerosols impact cloud condensation nuclei.
- BER brings unique scientific expertise in:
 - Modeling at pore to Earth system scales
 - Large scale, long-term ecological experiments
 - Ecosystem carbon cycling including soil carbon and microbial ecology/genomics

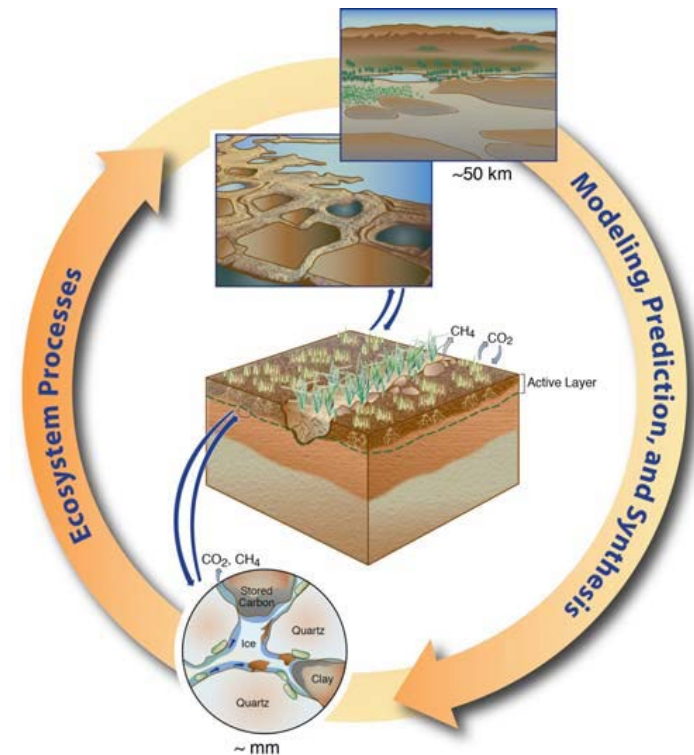

Tackling Major Climate Uncertainties: The Atmospheric Radiation Measurement Climate Research Facility (ARM)

- ARM provides unique, continuous, long-term measurements for innovative research to address two largest uncertainties in climate models: the roles of clouds and aerosols in climate change
- ARM's high-resolution, three-dimensional documentation of evolving cloud, aerosol, and precipitation characteristics has transformed our understanding and model representations of aerosol-cloud interactions.
- In FY 2013, ARM begins measurements in regions of high scientific interest, e.g., the Azores (marine clouds) and Alaska (Arctic clouds and aerosols over land, sea, and ice).
- In 2014, ARM will conduct an experiment, GOAmazon2014, to examine the role of tropical systems in global climate. The focus will be the coupled atmosphere-cloud-terrestrial tropical systems.

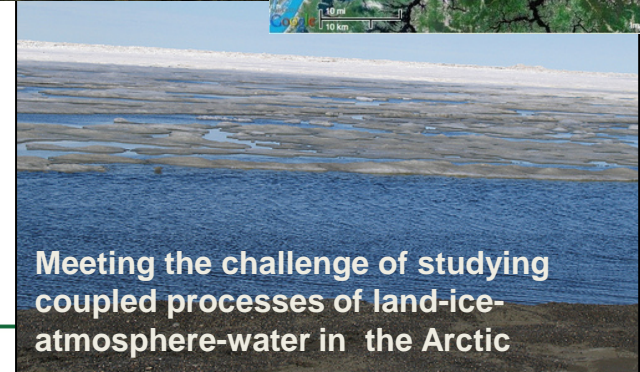
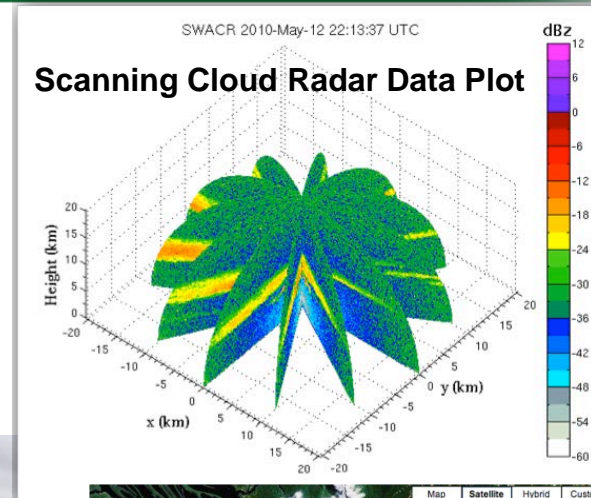

DOE Provides End-to-End Contributions for the International Panel on Climate Change (IPCC) Fifth Assessment Report (AR5)

- Emissions: the base-line central estimate future emission scenario
- Community Earth System Model DOE-funded major upgrades include:
 - Community Land Model, terrestrial carbon
 - Atmospheric aerosols, fast chemistry
 - Sea-ice and land-ice
 - Ocean
- Program for Climate Model Diagnostics and Intercomparison: provides data archive, diagnostics, analysis, and software tools to the international community, using the Earth System Grid portal
- Authors: DOE funds the research of 25 of the AR5 IPCC lead and editorial authors, contributes as lead author on Radiative Forcing chapter.

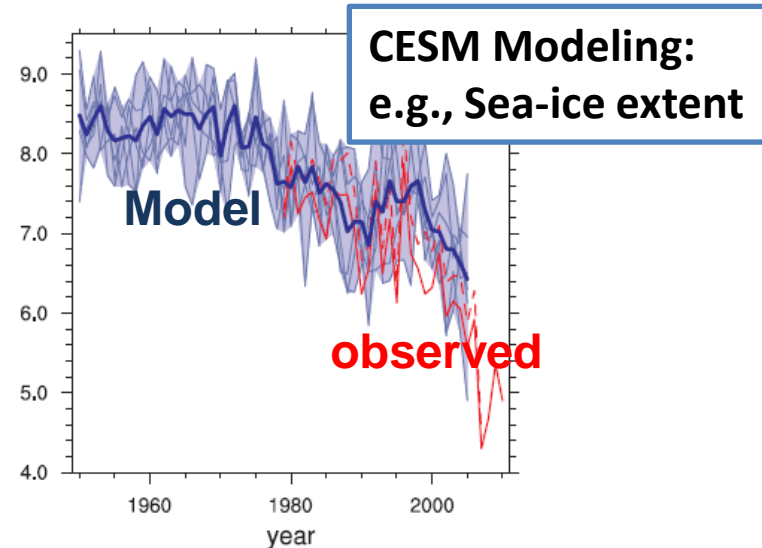
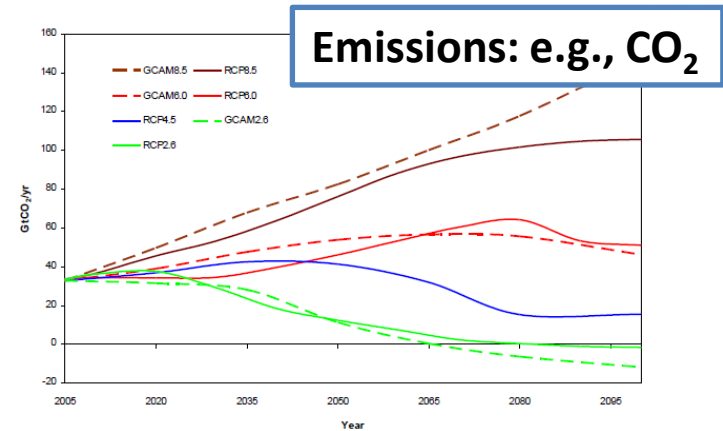

Diagnostics

Key Partnerships with Other Federal Agencies

- **Coordination of Climate Research through the United States Global Change Research Program (USGCRP).**
 - Flexible, integrated, robust, and responsive enterprise, organized around cross cutting themes, that draws on the unique attributes and expertise of Federal agencies to advance the knowledge needed to inform adaptation and mitigation policy and activities.
 - **Significant contributions of lead agencies**
 - NASA: Climate observations using space assets
 - NOAA: Climate measurements and modeling in support of public safety
 - **DOE: Climate research in support of future energy decisions**
 - NSF: Climate research in support of national scientific capacity and innovation
- **Joint USDA-DOE Plant Feedstock Genomics for Bioenergy**
 - Competitive merit-based program with USDA-National Institute of Food and Agriculture
 - Leveraging DOE genomics expertise with USDA stewardship of public breeding programs to develop bioenergy crops



United States Department of Agriculture
National Institute of Food and Agriculture

Fusion Energy Sciences

Understanding matter at very high temperatures and densities and building the scientific foundations for a fusion energy source

The Scientific Challenges:

- Control a burning plasma state to form the basis for fusion energy.
- Develop materials that can withstand the harsh heat and neutron irradiation in fusion facilities.
- Manipulate and control intense transient flows of energy and particles.
- Control the interaction of matter under extreme conditions for enabling practical inertial fusion energy.

FY 2013 Highlights:

- ITER construction is advancing.
- DIII-D investigates predictive science for ITER; NSTX undergoes performance upgrade; and Alcator C-Mod is closed.
- Matter in Extreme Condition Instrument begins operation at LCLS to study high-energy-density laboratory physics.
- New SciDAC high-performance computing projects are selected, in partnership with ASCR, to advance scientific discovery.
- International activities on experiments with world-leading technologies are increased.
- Fusion materials research is enhanced.

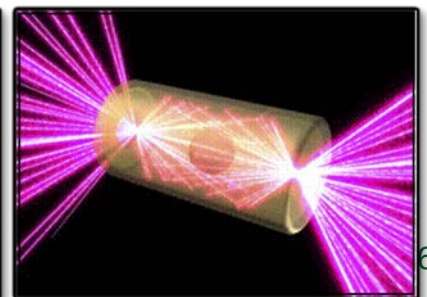
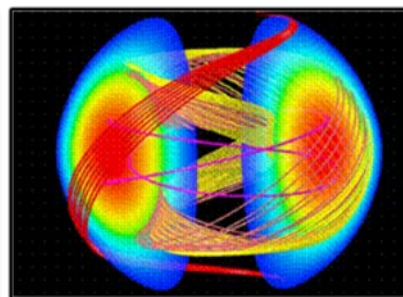
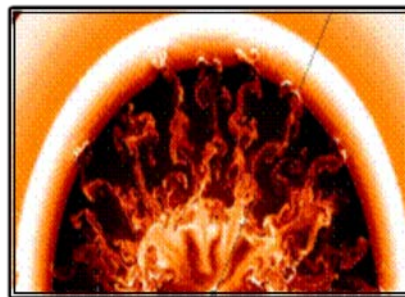
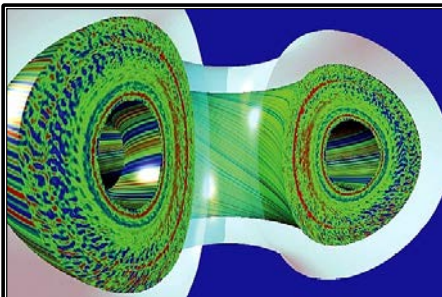

The ITER Project

- ITER will build and achieve the first demonstration of high-gain fusion energy production—fusion power 10 times greater than that used to heat the plasma.
 - The U.S. is a member of the ITER partnership, which includes China, the EU, Japan, Korea, and Russia – representing more than half the world’s population.
 - The 35-year activity in France will design, build, operate, and decommission the ITER device.
- The National Academy of Sciences supports the world community consensus that ITER is the required step to demonstrate the scientific and technical feasibility of fusion energy.

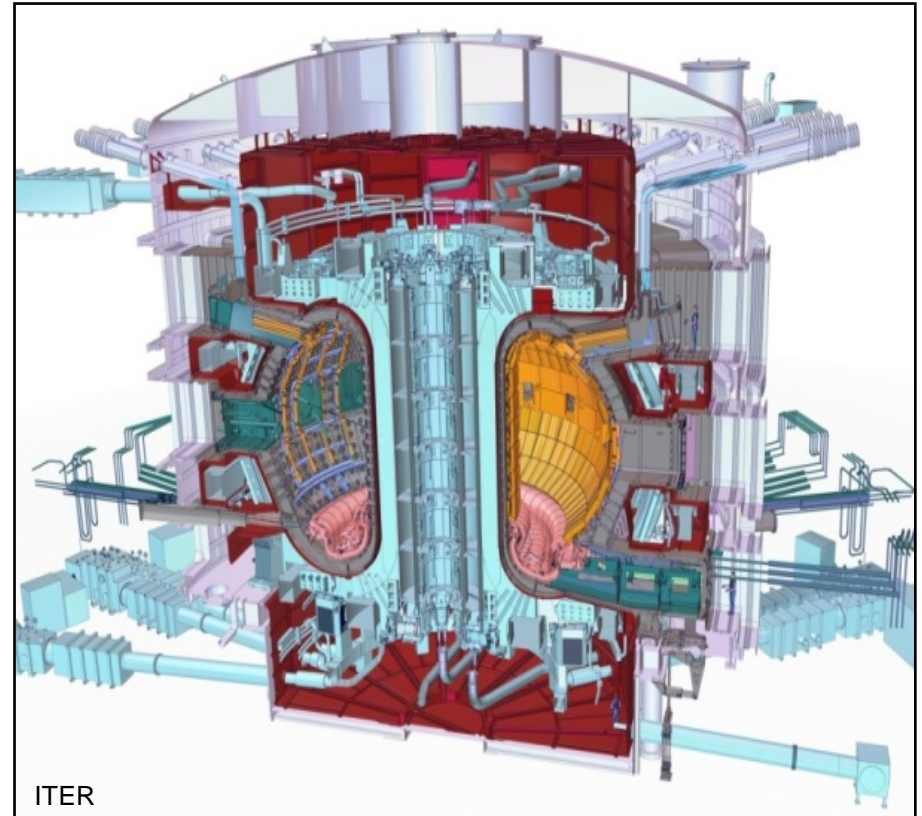

Progress on the ITER Project

Construction is well underway.

- All ITER Members show a strong commitment to completion of the ITER project. The EU has committed 2B Euros for the next two years; Japan funding triples for FY 2012.
- The new leadership team, including U.S. participation at the highest levels, has streamlined operations, reduced costs, and maintained schedule despite challenges such as the Japanese earthquake.

Among the "standing soldiers" at the bottom of the Tokamak Pit, it's easy to distinguish the future location of the machine by the spokes that branch out from a central plinth (January 2012).



Precise and careful alignment for Seismic Pad #100: Early November 2011, workers completed the installation of seismic pad number 100.



U.S. Funding for ITER

U.S. jobs, high-tech U.S. manufacturing, industry funding from ITER overseas partners

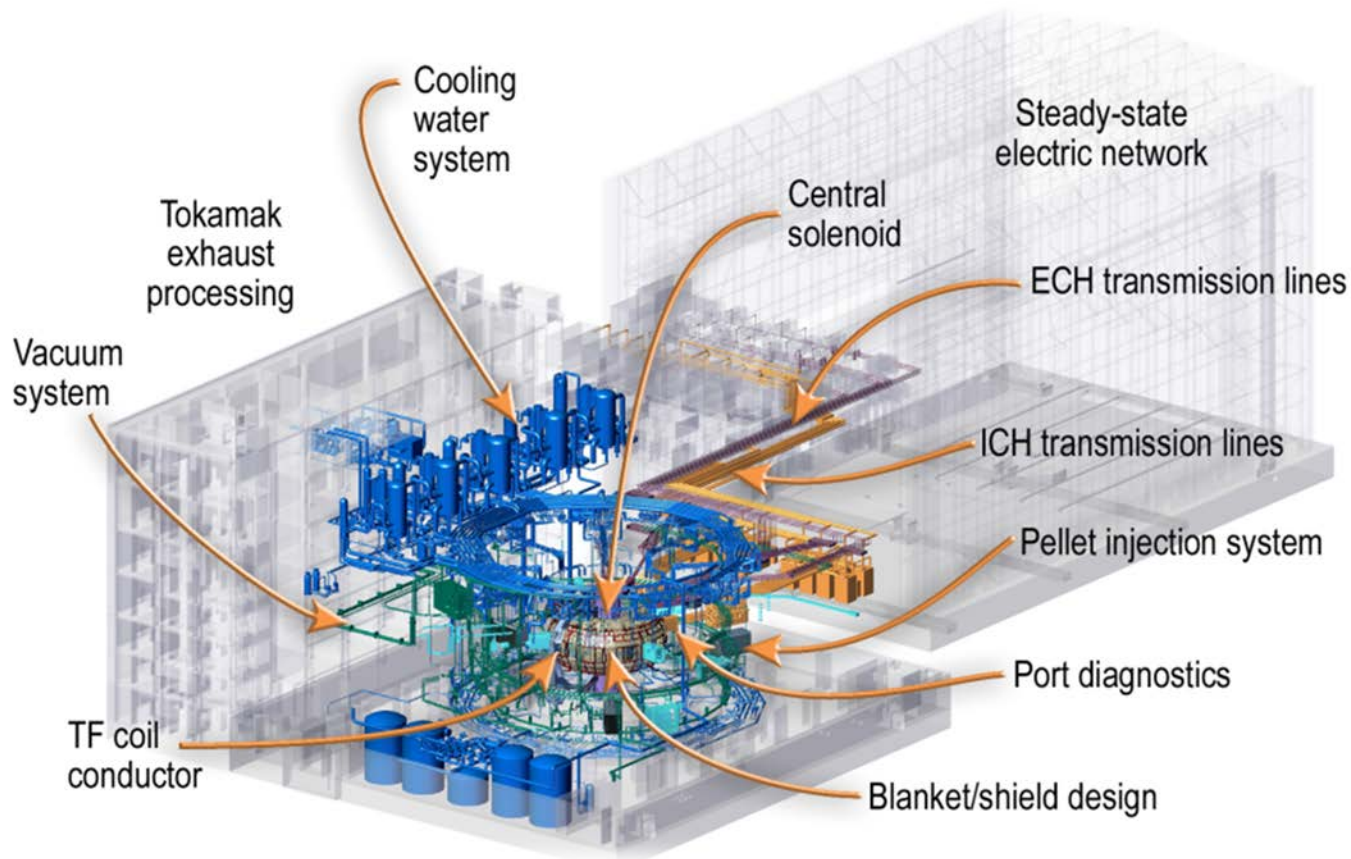

U.S. in-kind deliverables

Attracting business

- The EU has let a contract to Oxford Instruments, New Jersey, for its superconducting strand (\$58M)
- Luvata Connecticut is supplying US TF strand to the EU (\$26M)

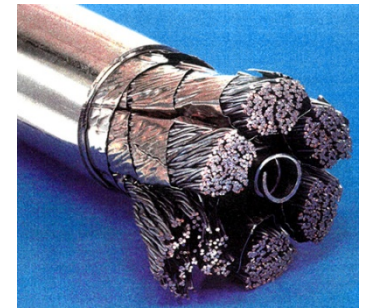

U.S. DEPARTMENT OF
ENERGY

Office of
Science

U.S. Funding for ITER

U.S. jobs, high-tech U.S. manufacturing, industry funding from ITER overseas partners

Funding in FY 2012 of \$105M will:

- Support jobs in >300 industries and universities and 8 National Labs in 37 states
- Provide US industry experience with advanced manufacturing techniques

Funding to DOE Labs
March 2006 – December 2011
Total ~\$168M



Funding to Industries and Universities
March 2006 – December 2011
Total ~\$153M

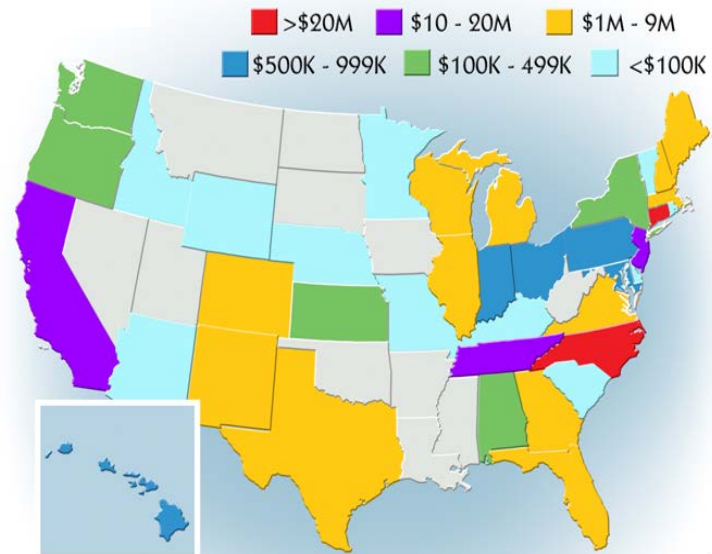

US ITER Future Contracts ~\$1B



U.S. DEPARTMENT OF
ENERGY

Office of
Science

NSTX Upgrades Provide World-Leading Capability

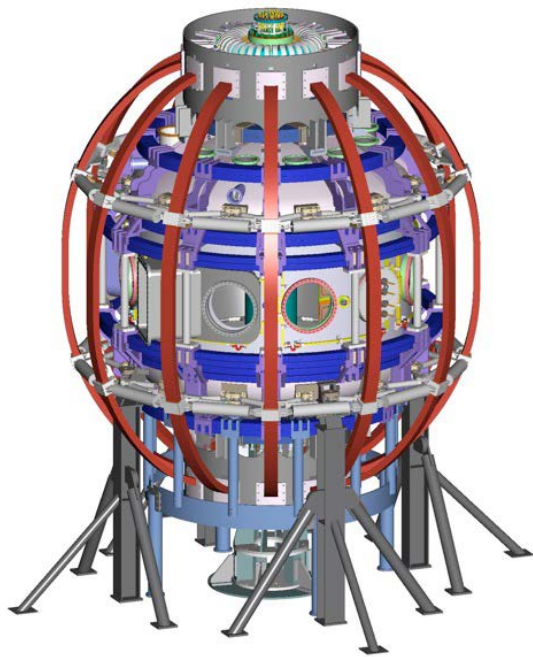

The completed NSTX

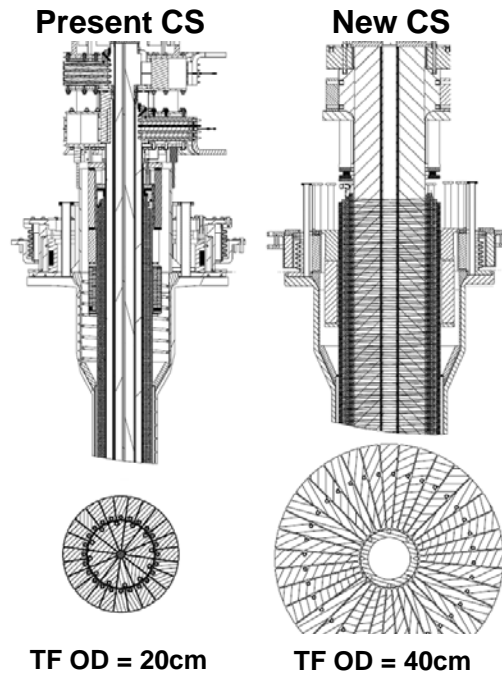

Center-stack magnets

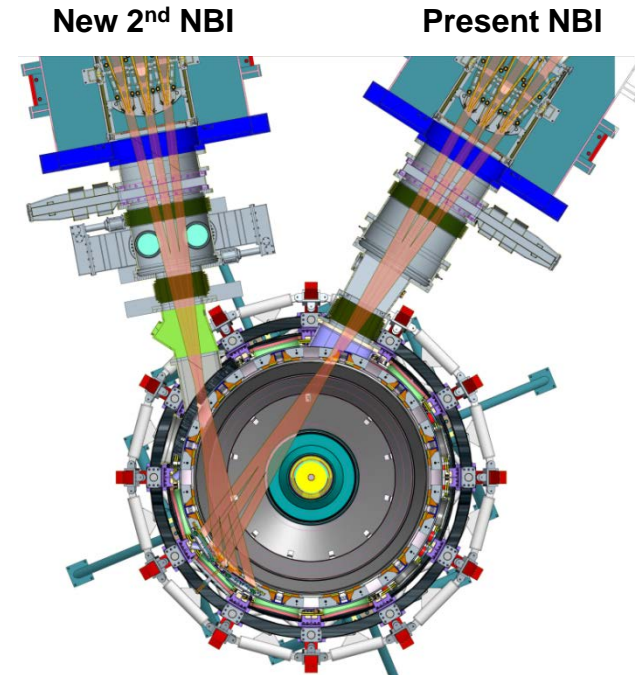

Neutral-beam capabilities

- Upgrade will provide world-leading capability for this configuration.
- Goal: assess the viability of this aggressive, compact tokamak geometry as a fusion neutron source for testing fusion materials and components
 - Double capacity in the magnets and heating → increase pulse length by 5x; increase temperature; drive up to 100% of the current without a central solenoid

Matter in Extreme Conditions Instrument at LCLS

Completed this spring ahead of schedule and within budget

- Matter in Extreme Conditions Instrument (MECI) at the Linac Coherent Light Source (LCLS) will investigate the properties of matter far from equilibrium; it will enable the first user science for warm dense matter investigations.
- MECI will be commissioned during the 5th experimental run of the LCLS this spring, 11 months prior to the Critical Decision-4 (CD-4) project milestone.

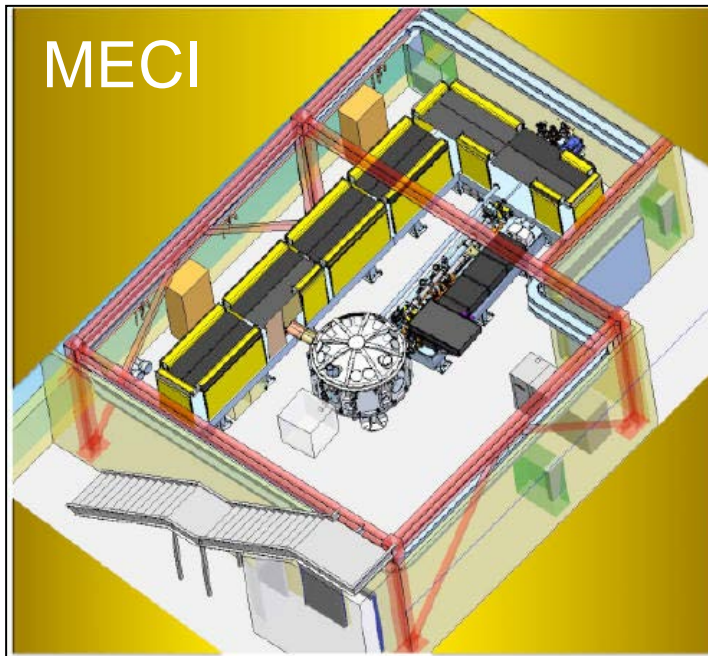

Commissioning Experiments

- Investigation on the stability of tungsten zone plates irradiated with 8 keV FEL pulses
Ulrich Vogt (Royal Institute of Technology, Sweden)
- High-resolution phase contrast imaging of shock waves in matter using compound refractive X-ray optics
Andreas Schropp (Volkswagen Visiting Fellow)
- The perfect probe: Charge state distributions in warm dense matter
Justin Wark (Oxford University)



MIT's Alcator C-Mod Closes in FY 2013

- The closure of Alcator C-Mod marks the end of a scientifically rich program of high impact contributions to U.S. fusion science
- Research staff will be supported in FY 2013 to complete data analysis and will begin transition to other facilities in the U.S. and abroad; priority will be given to completing graduate student research

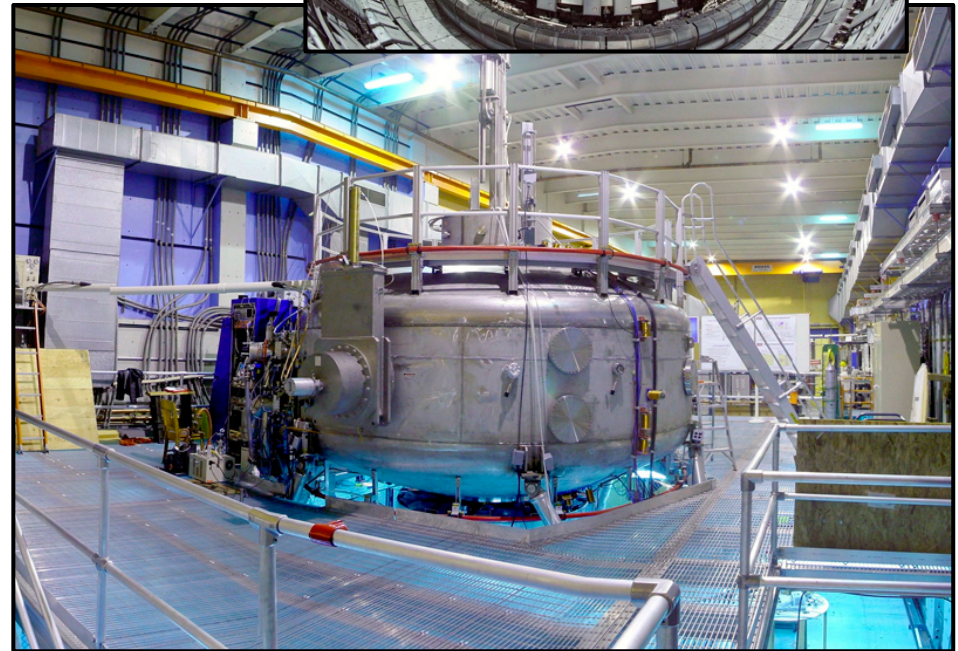
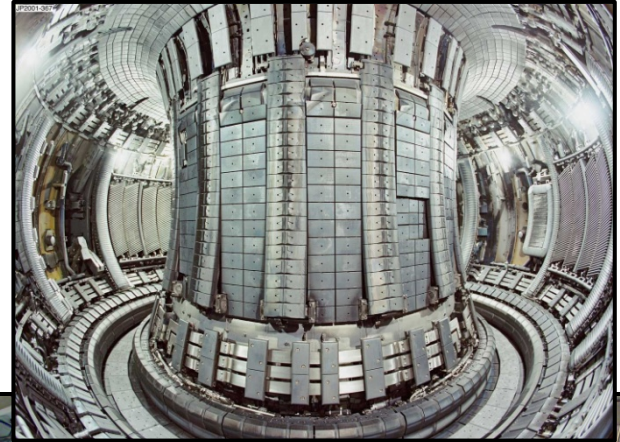

The Alcator C-Mod facility at MIT



International Collaborations

U.S. engagement in international collaborations will provide access to new facilities using superconducting magnets that will enable first-of-kind very long fusion plasma pulses (towards 1,000 seconds).

- Steady-state control of high performance plasmas
- Plasma surface interaction in steady-state plasmas
- Confinement in 3-D configurations

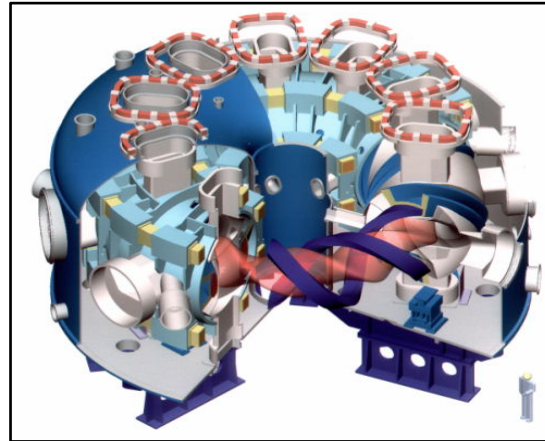

LHD stellarator (Japan)

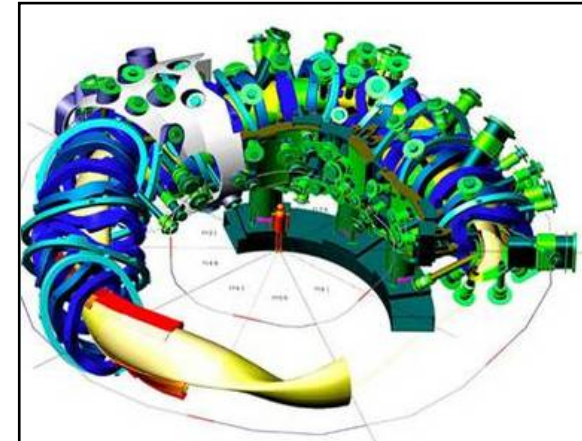

Wendelstein 7-X stellarator (Germany)

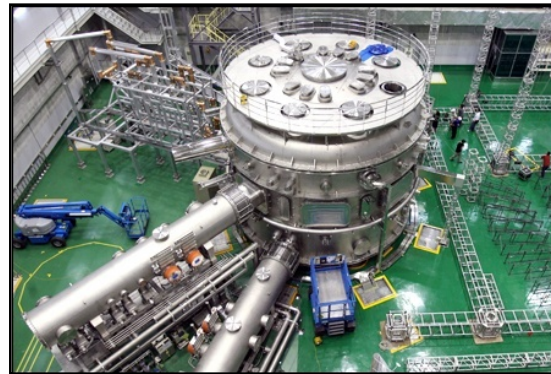

KSTAR tokamak (S. Korea)



EAST tokamak (China)

Simulation Captures Details of Small-scale Instabilities Induced by the Fusion Process

- Alpha particles created by fusion will self-heat a fusion plasma. However, they also induce small-scale plasma instabilities (reverse shear Alfvén eigenmodes - RSAEs). These can modify fusion heating and current drive in ITER.
- DIII-D used flexible fast particle injection capability to turn these instabilities on and off, allowing detailed study
- Independent SciDAC simulations of the rate capture details of the DIII-D experimental observations

Electron temperature fluctuation measurements

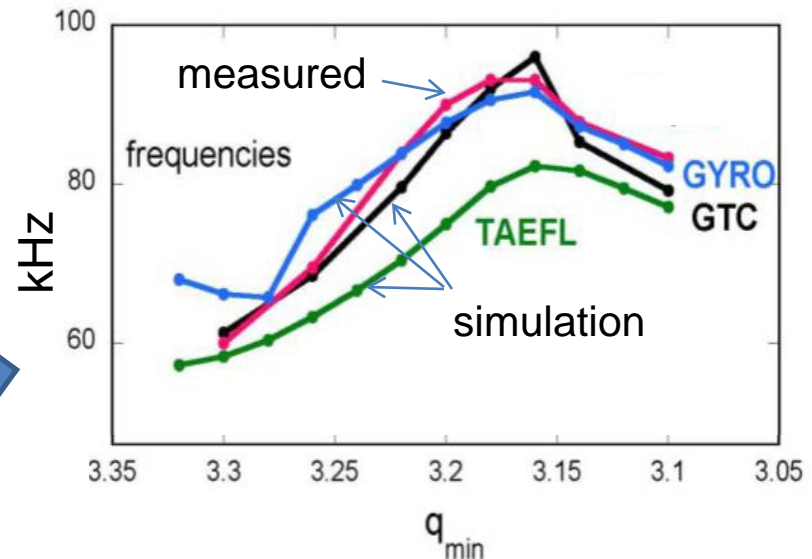
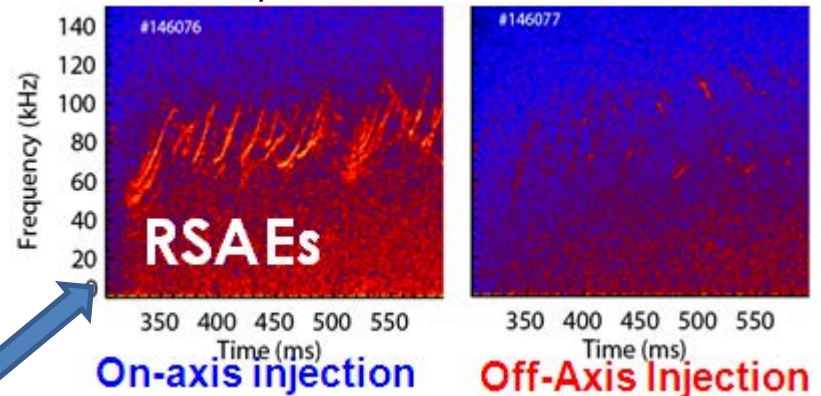

High Energy Physics

Understanding how the universe works at its most fundamental level

The Scientific Challenges:

- Determine the origins of mass in terms of the fundamental particles and their properties
- Exploit the unique properties of neutrinos to discover new ways to explain the diversity of particles
- Discover new principles of nature, such as new symmetries, new physical laws, or unseen extra dimensions of space-time
- Explore the “dark” sector that is 95% of the Universe (Dark Matter and Dark Energy)
- Invent better and cheaper accelerator and detector technologies to extend the frontiers of science and benefit society

FY 2013 Highlights:

- Energy Frontier: Continued support for U.S. researchers at the LHC. The number of researchers is constant with FY 2012
- Intensity Frontier: Research, design, and construction for NOvA, LBNE neutrino experiments, and Mu2e muon experiments. The Reactor Neutrino Experiment in China begins operations in FY 2012
- Cosmic Frontier: U.S. participation in international collaborations pursuing dark matter, dark energy. The Dark Energy Survey in Chile begins operations in FY 2012
- Research in accelerator technologies including superconducting radio frequency and plasma wakefield acceleration

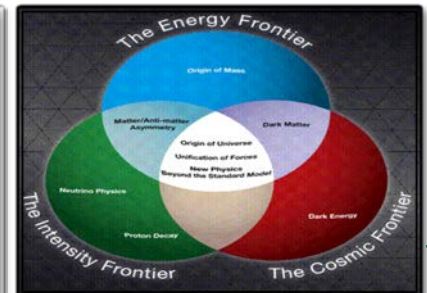
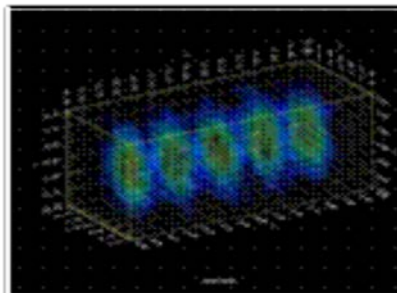
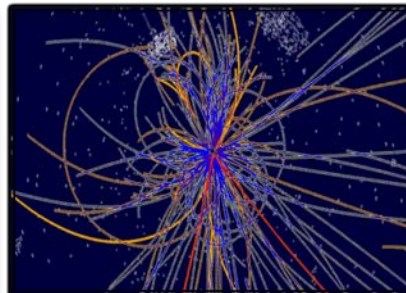

The Energy Frontier

- The Tevatron at FNAL has successfully completed its run on September 30, 2011.
 - Delivering 12 fb^{-1} of luminosity to each of the CDF and D-Zero detectors.
- The LHC is now running extremely well.
 - In 2011 the LHC delivered 5 fb^{-1} to each of the large detectors ATLAS and CMS.
 - ATLAS and CMS have now excluded the Standard Model Higgs Boson for all masses except in the range 116 to 127 GeV/c^2
 - LHC is expected to discover or rule out the SM Higgs Boson across the entire mass range by the end of 2012.



The Intensity Frontier: Neutrinos and Rare Processes

- The Intensity Frontier uses intense particle beams to uncover properties of neutrinos and observe rare processes that point to new paradigms of physics.
- The U.S. is poised to make significant advances at the Intensity Frontier.
- The FY 2013 budget request builds on unique capabilities at Fermilab and supports associated research in Intensity Frontier physics.

Neutrino Physics

- **Mixing:** Experimental evidence that neutrinos can switch (“mix”) from one type to another proved that these elementary particles have non-zero mass, which violates the predictions of the Standard Model of particle physics.
- More detailed measurements of mixing in neutrinos and other elementary particles could reveal differences between matter and antimatter and discover new physics.

Rare Processes

- The Mu2e experiment will search for the conversion of a muon to an electron in the field of a nucleus.
- This is expected to be a very rare event, and an intense source of muons and a large detector will be required.
- This experiment searches for fundamentally new symmetries in the laws of nature.

The Neutrino Physics Program

- Neutrinos from the Main Injector (NuMI) is the most intense neutrino beamline in the world.
- Experiments using this beamline use a detector near the neutrino source at Fermilab and also a far detector, hundreds of kilometers away.
- Experiments seek to quantify neutrino mixing, measure the neutrino masses, and detect the effects of matter on neutrinos as they pass through the earth.

Summary of key experiments:

- **MINOS** – This experiment has produced the most precise measurement of one of the neutrino mass differences. Operations continue to collect data for initial measurements of neutrino and antineutrino behavior.
- **NuMI Off-Axis Electron Neutrino Experiment (NOvA)** – NOvA will provide precision measurements of neutrino mixing and will seek to determine the relative masses of neutrinos.
 - Funds are requested to continue construction in FY 2013. Partial operations are planned to begin in FY 2013.
 - The Fermilab Accelerator Complex will be shut down for about half a year for upgrades to the beam power to the NuMI beam for NOvA.
- **Daya Bay Reactor Neutrino Experiment** – Begins operation in FY 2012 in China. It makes a pure measurement of neutrino mixing unaffected by CP violation or the effects of matter on neutrinos. Can be combined with other experiments to extract more information.



The trajectory of the NuMI beam and far detectors

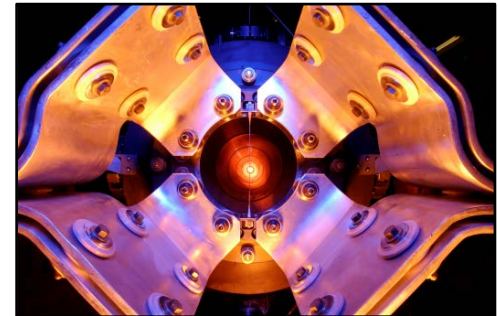

The NuMI horn, part of the neutrino sources

The Questions - Experimental Neutrino Program

- **Key remaining questions:**
 - Where did all the antimatter go ?
 - Why are there so many different types (“flavors”) of neutrinos?
 - Are neutrinos “normal”?
 - Are there hidden phenomena we have not yet discovered ?

	Experiment	AntiMatter	Flavors	Normal?	Hidden Sector	Technology R&D
reactor	Double Chooz		**	-	-	
	Daya Bay		***	-	-	*
high energy ν	MINOS		**	-	*	*
	T2K	*	**	-	*	*
	NO ν A	**	***	*	**	*
	LBNE	***	****	***	***	***
low energy ν	Minerva	--	---	---	*	*
	MicroBooNE	--	--	---	**	**



The Homestake Mine

- The FY 2012 Request includes \$10M to maintain the viability of the Homestake Mine, including dewatering and maintaining security.
- The Liquid Underground Xenon (LUX) dark-matter experiment will begin operations in March 2012 in a cavern supplied by South Dakota and will run through 2013.

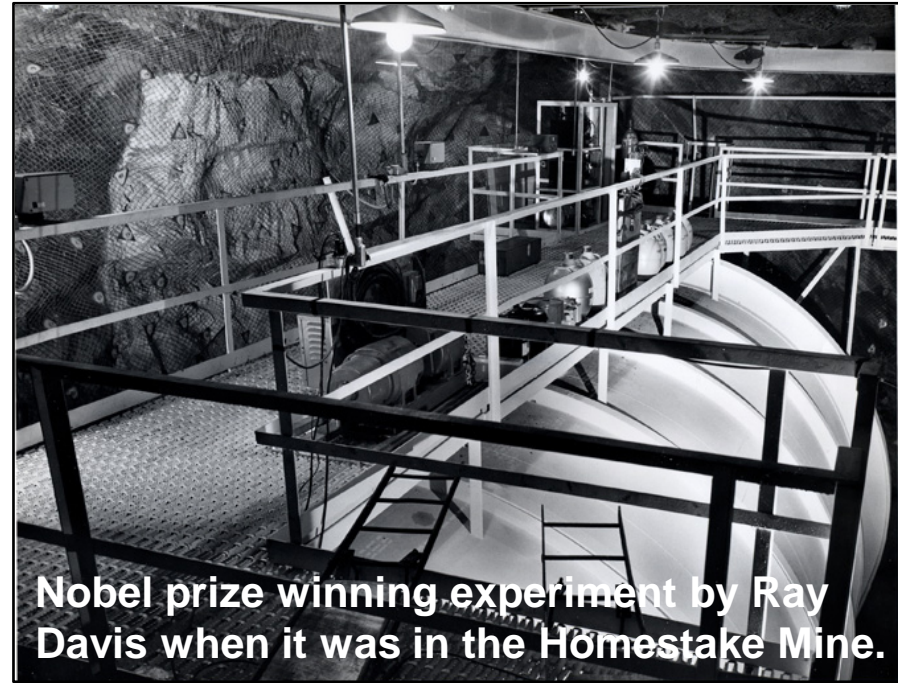

Nobel prize winning experiment by Ray Davis when it was in the Homestake Mine.



Water tank that will hold LUX experiment now in the Davis Cavern

- Operations of the Homestake Mine for science will hinge on the decision on whether to go forward with the Long Baseline Neutrino Experiment, which is expected in March. DOE has received a recommendation on what technology to employ for the detector.

Floor support above water tank



New User Facility for Accelerator R&D

- The Facility for Advanced Accelerator Experimental Tests (FACET) at SLAC received CD-4 in January 2012.
- FACET will operate as a national user facility for accelerator R&D with open access based on peer review.
- It will use the front end of the SLAC linac to supply electron beams with high energy (20 GeV) and short bunch lengths.
- Plasma wakefield experiments will be in the first run.



HEP is supporting this facility as part of its accelerator R&D stewardship initiative.

Workforce Development for Teachers and Scientists

Encouraging and supporting the next generation of scientific talent

Program Goals:

- Increase the pipeline of talent pursuing research important to the Office of Science
- Leverage the resources of the DOE national laboratories for education and training
- Increase participation of under-represented students and faculty in STEM programs
- Improve methods of evaluation of effectiveness of programs and impact on STEM workforce

FY 2013 Highlights:

- Research Experiences at DOE Labs—
 - Science Undergraduate Laboratory Internship
 - Community College Internships
 - Visiting Faculty Program
- National Science Bowl (NSB)—Regional and national middle school and high school competitions to encourage education and careers in science, with 22,000 students from 1,500 schools
- Einstein Distinguished Educator Program—DOE hosts 6 elementary and secondary school mathematics and science teachers at DOE HQ or in Congressional Offices.

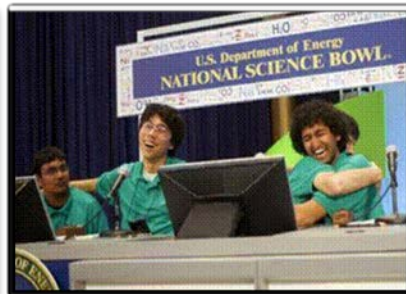

Science Laboratory Infrastructure

Supporting infrastructure and fostering safe and environmentally responsible operations at the Office of Science laboratories

Program Goals:

- Support scientific and technological innovation at the Office of Science (SC) laboratories by providing state-of-the-art research space in modern, safe, and sustainable laboratory facilities.
- Correct longstanding infrastructure deficiencies while ensuring laboratory infrastructure provides a safe and quality work environment.
- Support stewardship responsibilities for the Oak Ridge Reservation and the Federal facilities in the city of Oak Ridge, and provide payments in lieu of taxes to local communities around the Argonne, Brookhaven, and Oak Ridge National Laboratories.

FY 2013 Highlights:

- Funding is initiated for facilities and infrastructure at the OSTI facility in Oak Ridge and the NBL facility at ANL, which was previously budgeted through the SCPD budget.
- Final funding in FY 2012 for Interdisciplinary Science Building – I (BNL) (CD-4 in FY 2013), Technology and Engineering Development Facility (TJNAF) (CD-4 in FY 2014), and Seismic Ph 2 (LBNL) (CD-4 in FY 2015).
- Continuation of four line-item construction projects at ANL, BNL, and SLAC.
- 2 construction starts at FNAL and TJNAF to upgrade, expand, and extend the useful life of utilities systems

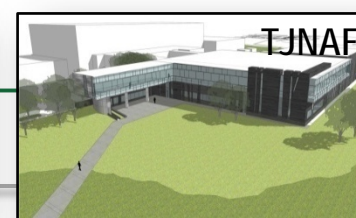

Safeguards and Security

Supporting appropriate levels of protection against unauthorized access, theft, or destruction of DOE assets and hostile acts

Program Goals:

- Provide physical and cyber security controls at SC national laboratory facilities to mitigate risks to facilities and laboratory employees to an acceptable level while enabling the mission.
- Assure site security programs result in secure workplaces that facilitate open and collaborative scientific advances.
- Align accountability for performance through National Standards, rigorous peer review, and Federal oversight through mature contractor assurance systems.
- Protect special, source, and other nuclear materials, radioactive material, and classified and unclassified controlled information at SC laboratories.

FY 2013 Highlights:

- Support for the baseline level of protection to provide mission tailored security.
- Complete security risk assessments at all SC sites to determined required security protection levels.
- Full recovery for Safeguards and Security services to non-DOE customers to reduce pressure on overhead burdens and Safeguard and Security budgets.
- Oversight through mature contractor assurance systems to minimize duplicative audits and assessments.
- Investments in infrastructure and automation technology to reduce reliance on personnel for routine security functions and long-term costs.



Program Direction

Supporting a skilled workforce to oversee Office of Science investments in world-leading scientific research

Program Goals:

- Ensure the recruitment and retention of a highly skilled workforce to provide the planning, execution, oversight, and management of the Office of Science's research programs and world-leading facilities
- Provide an effective modernized business infrastructure to support the scientific mission
- Provide public access to DOE-supported research results
- Support professional development opportunities for the Office of Science workforce
- Working to improve efficiency and transparency of operations

FY 2013 Highlights:

- Supports salaries and benefits of 1,048 FTEs across the Office of Science complex.
- Supports the development of an improved internal grants management system through best-in-class software development.
- Supports development of an integrated, transparent information technology system between HQ and Field operations looking to cloud computing and other cost efficiency gains.

