



A Magnetized Electron Source for Ion Beam Cooling

DoE Phase II SBIR

Joseph Conway, Bruce Dunham, Ralf Eichhorn, Colwyn Gulliford,
Val Kostroun (PI), [Christopher Mayes](#), Karl Smolenski, Nicholas Taylor



Outline

- Company Overview
 - Need for magnetized beams
 - Phase I: Injector design
 - Phase II
 - Design
 - Fabrication
 - Testing at Xelera (Ithaca)
 - Testing at JLab
 - Summary
-



Company Overview

- Formed in 2013 by 5 partners – 150+ years of accelerator design expertise
 - Most of Xelera were from the Cornell ERL development team, who designed and built the world's highest current, high brightness photoinjector, which is being used now in the 4-pass ERL: CBETA
 - Now at 9 total employees
 - Focus Areas:
 - Accelerator design & simulations (EIC magnetized injector design)
 - Radiation physics consulting (ASU BioDesign C safety systems design)
 - Accelerator hardware:
 - Electron & X-ray beam stops (ASU Graves Lab)
 - Cathode transport systems (ASU Karkare Lab)
 - Vacuum system designs, coatings (JLab, Poelker)
 - Higher Order Mode loads (HZB, Germany)
 - Electron source design and fabrication (JLEIC Cooler Magnetized Gun)
-



EIC need for magnetized beam

- Electron cooling of the ion beam is a critical aspect of a successful electron-ion collider (EIC), possibly improving the luminosity by a factor of 5.
 - A (pre)magnetized beam becomes still in the cooling solenoid. This is done by immersing the cathode in a solenoid field.
 - Photoguns are highly flexible and offer control over the phase space of the bunch, but have not been proven reliable at very high currents.
 - A Thermionic gun could be a viable (low risk) plan B.
 - Xelera built a prototype Thermionic Gun (Tgun), and delivered it to JLab's Gun Test Stand (GTS) in July.
 - Testing at JLab is underway.
-

Magnetized Beams for EIC cooling

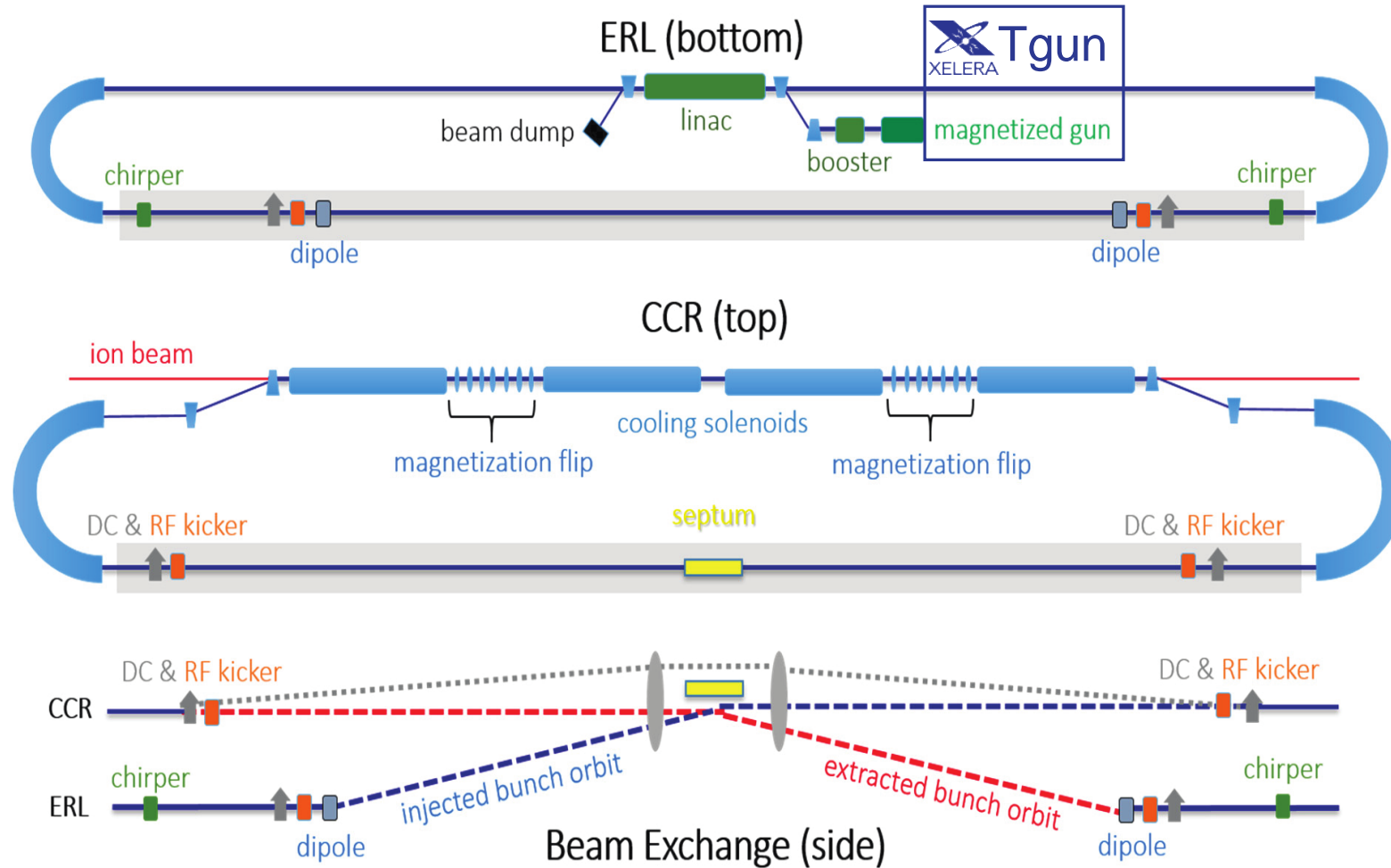

Phase I: Magnetized Injector Design

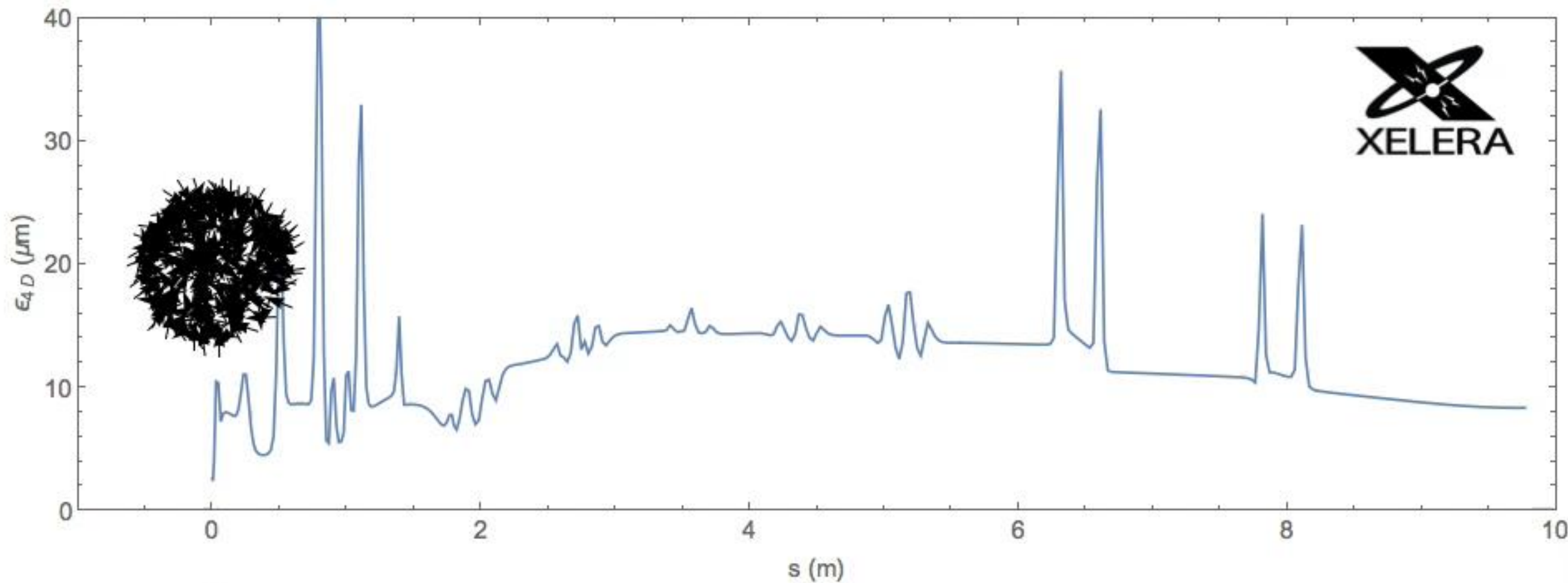

Phase I: Magnetized Injector Design

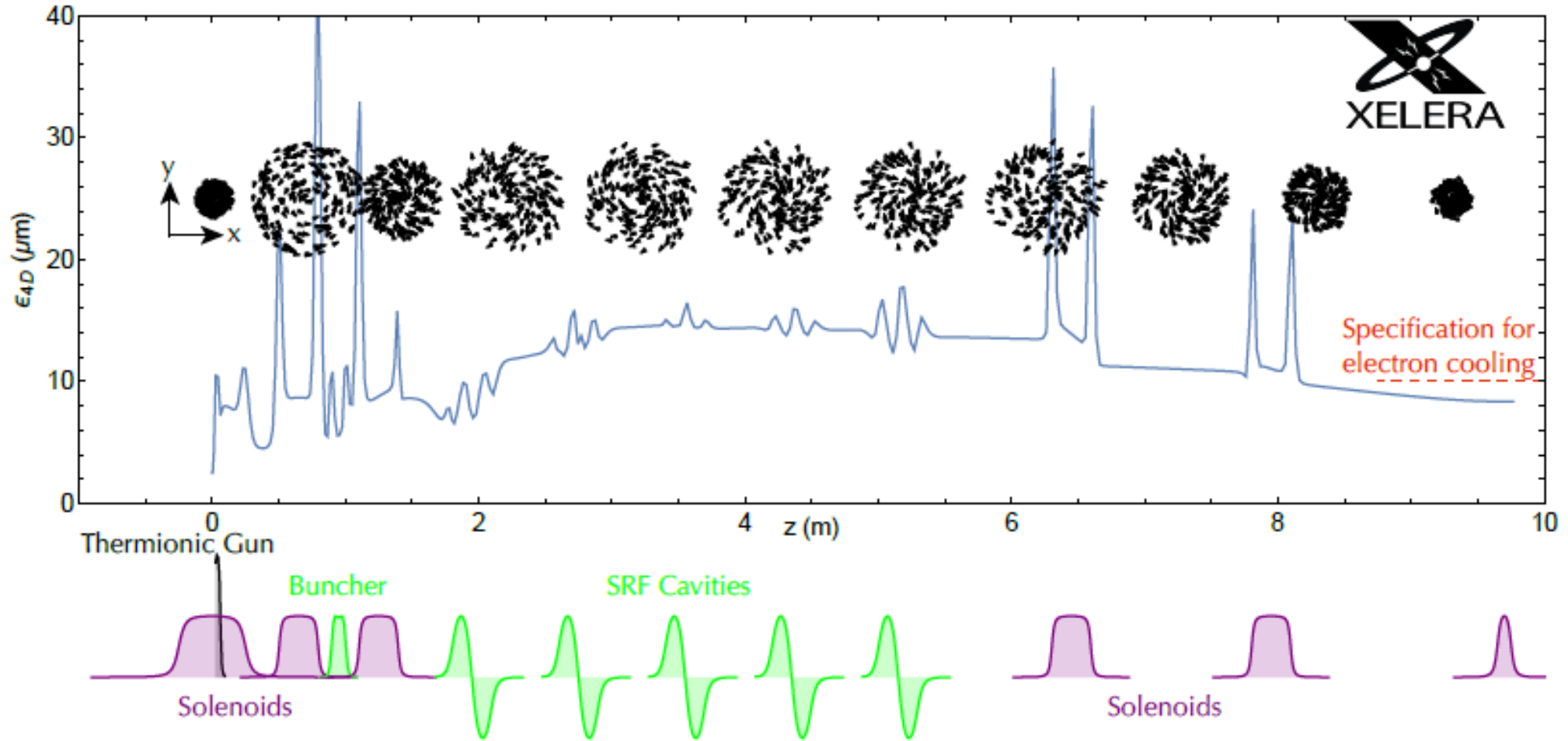



Phase II: Build a Magnetized Source –TGun

Proposal excerpts

1

if the beam parameters could still be met by a less complex and cheaper device. As discussed in §1.3, Phase I results indicate that with voltages as low as 200 kV the required 4D beam emittance can still be achieved. In further simulations we will continue investigating lower beam energy with the goal of still meeting ion cooling emittance requirements.

2

scientists, we decided to propose using gridded-thermionic gun with a 100 kV beam energy and 50 mA average current, as a first step towards the final goal. These

3

Once the gun is built and conditioned, it will be installed at JLab where its beam properties will be measured using their diagnostic beamline. If successful, a new

Beam Physics Design

Want optimal solution for low energy gun that works in GTS

Gun and Magnetizing Solenoid: 2D field maps

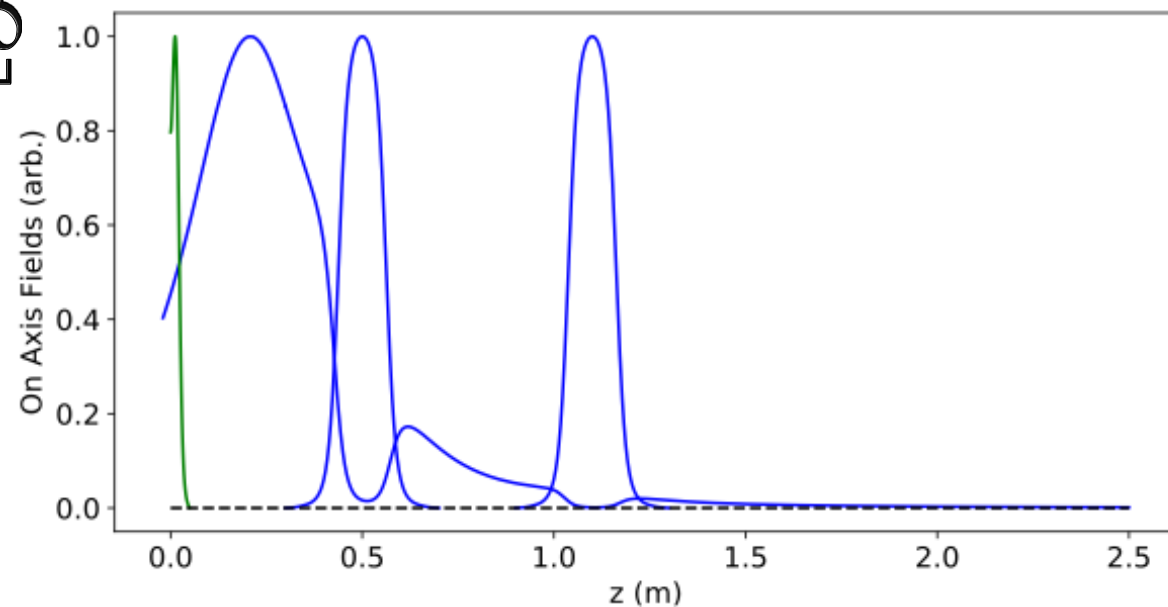
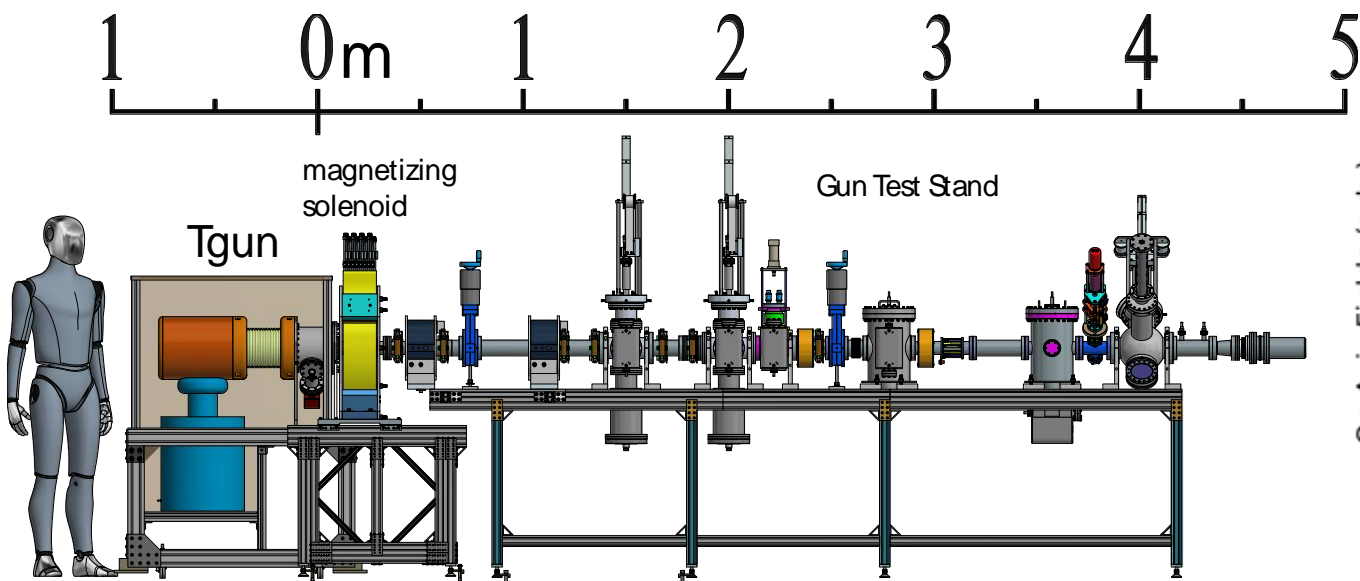



Optimization: Initial Beam/Gun Parameters

Subsystem	Parameter	Value
Cathode	Emission Radius R_e (mm)	4
	RF Voltage U_{rf} (Volt)	250
	RF Frequency f (MHz)	500
	Transconductance g_{21} (mA/Volt)	10
	Max Temperature T_c (Kelvin)	1500
	Maximum Peak Current $I_{p,max}$ (A)	1.25
Cathode Solenoid	Cathode Field $B_{cathode}$ (T)	0.0307
Gun	Voltage V (kV)	125
	Cathode-Anode Gap L (mm)	[5, 30]
	Cathode Angle θ_c (deg)	[15, 45]
	Anode Angle θ_a (deg)	[15, 45]
Initial Beam	Bunch Charge q_b (pC)	[0, 545]
	RMS Bunch Length σ_t (ps)	[0, 147]
	Half Emission Angle ψ (deg)	[0, 60]
	Thermal Emittance $\epsilon_{n,therm}$ (μm)	1.0
	Initial Emittance $\epsilon_{n,x,0} = 2\epsilon_{n,therm}$ (μm)	2.0
	Magnetized Emittance $\epsilon_{n,mag}$ (μm)	36
	Canonical Angular Momentum $\langle \mathcal{P}_\theta \rangle$ (neV·s)	122.8
	Transverse Thermal Energy $k_B T$ (meV)	129.26
	Effective Mean Transverse Energy MTE_{eff} (meV)	517.04

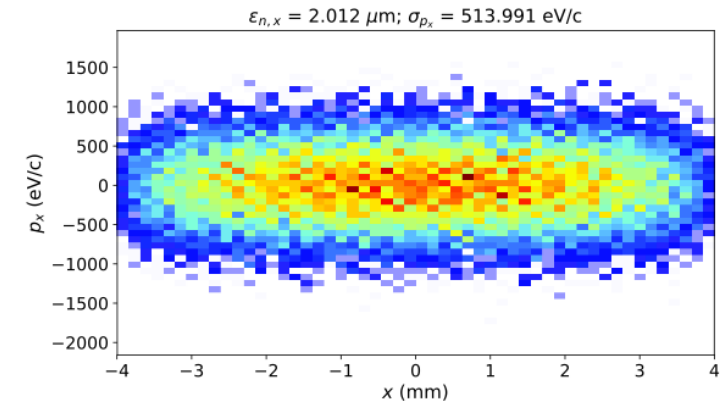
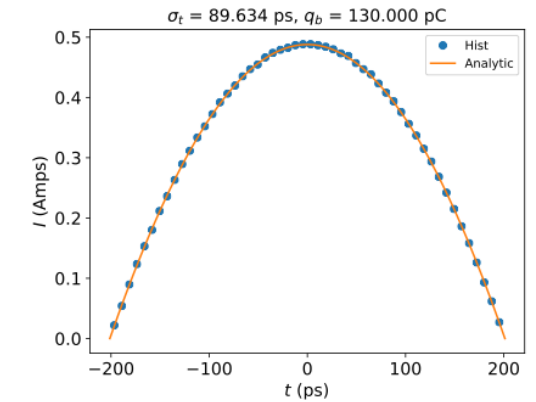
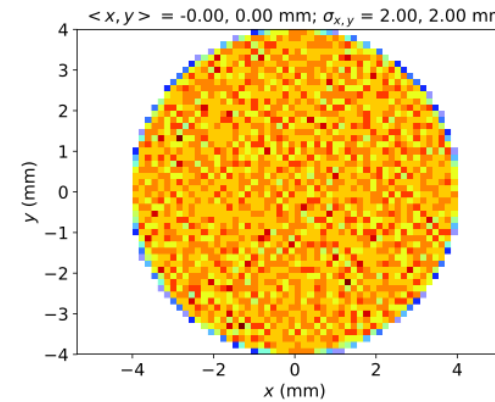

Optimization of Gun Parameters

- Cathode Anode Gap: 5-30 mm
- Cathode Angle: 15 - 45 deg
- Anode Angle: 15 - 45 deg
- Solenoid Strengths
- Optimized @ screen $z = 2.5$ m

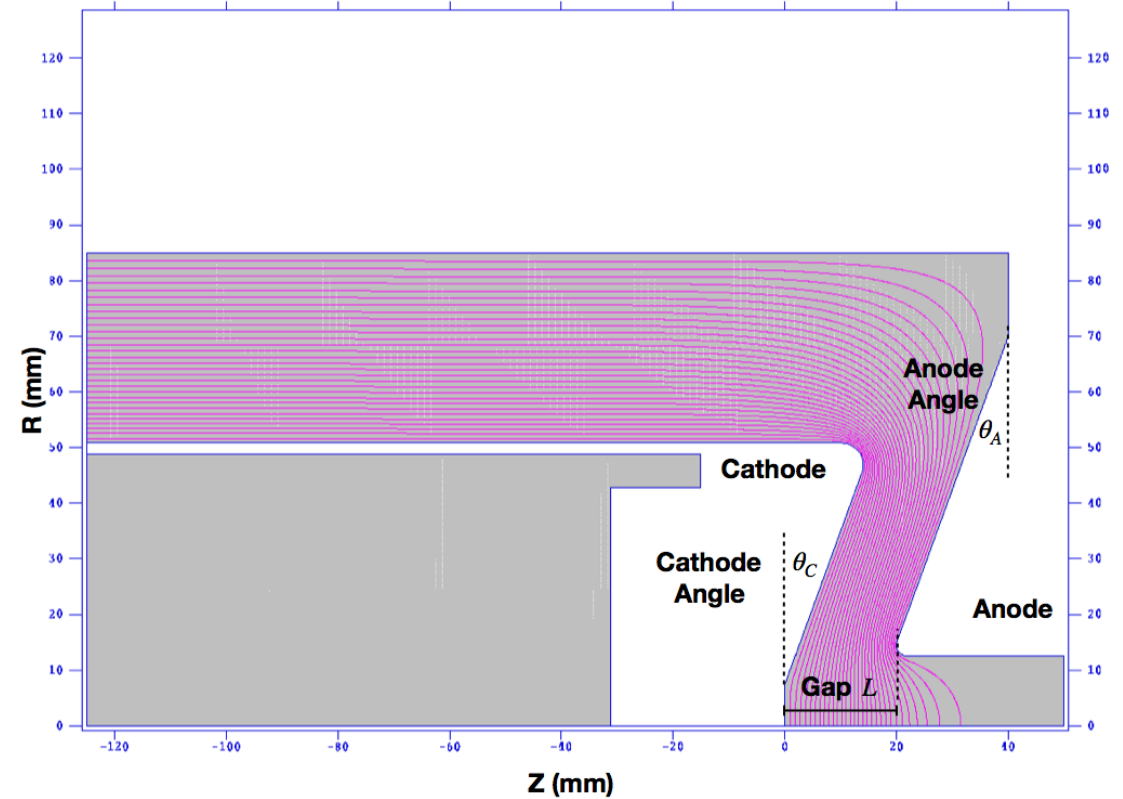

- After several parallel Multi-Objective Genetic Algorithm Optimizations, fixed on a single electrode design
- Gap 26 mm (Optimal: 20 mm, but keeps fields down, negligible penalty to emittance)
- Meets beam dynamics requirements:
 1. Magnetized beam
 2. Bunch charge sufficient for high current demonstration

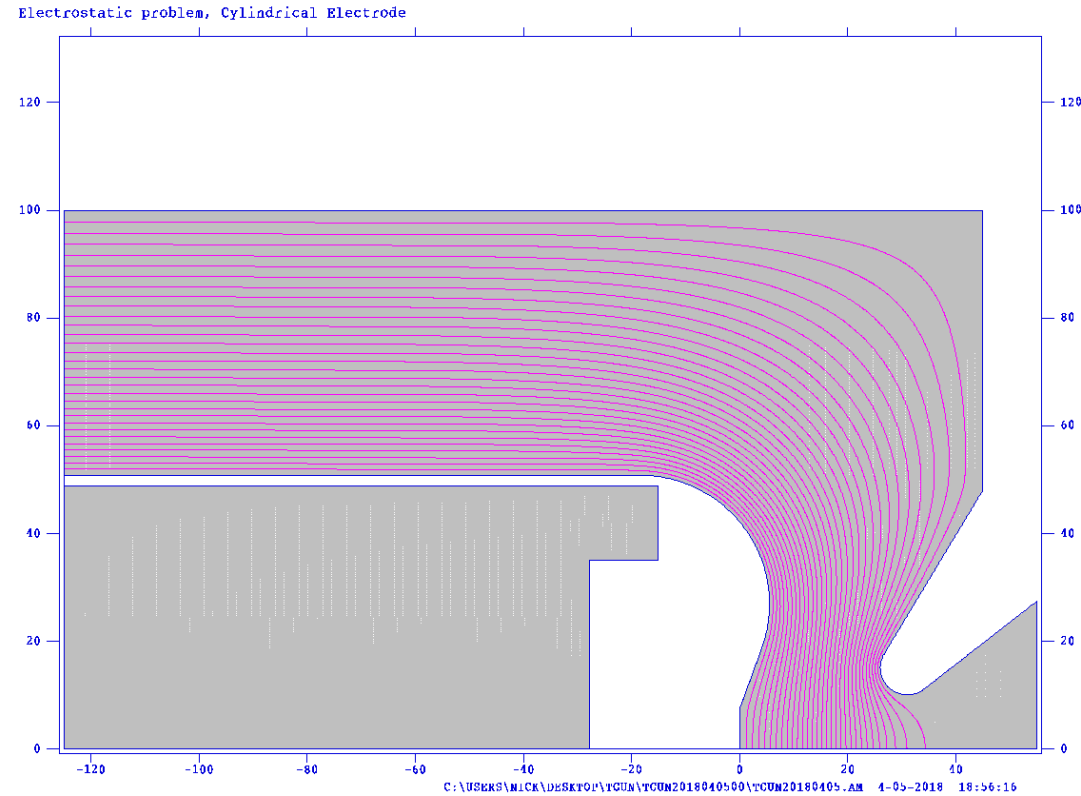



Close up on Anode-Cathode Gap Region

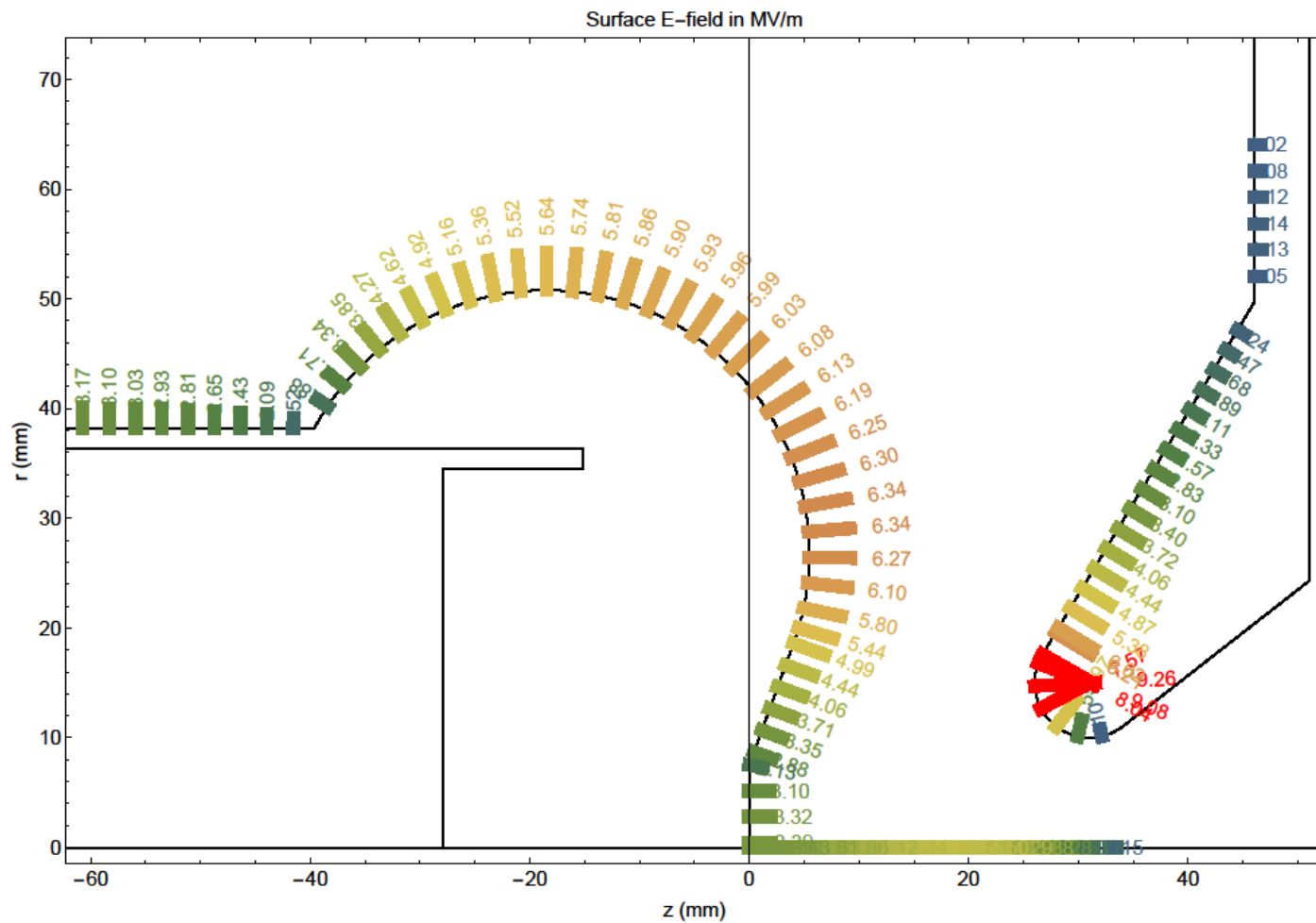

Max surface field on Cathode about 6.3 MV/m



Complete Model in Poisson (LANL)

Electrostatic problem, Cylindrical Electrode

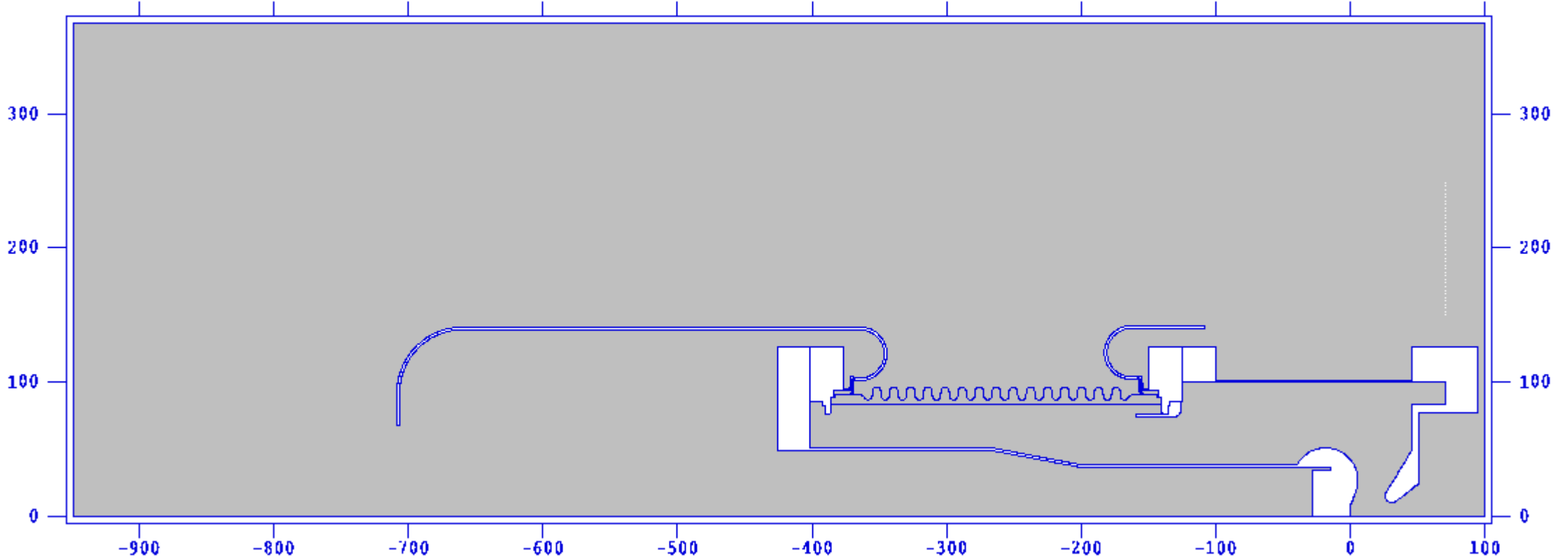

Electrostatic Design

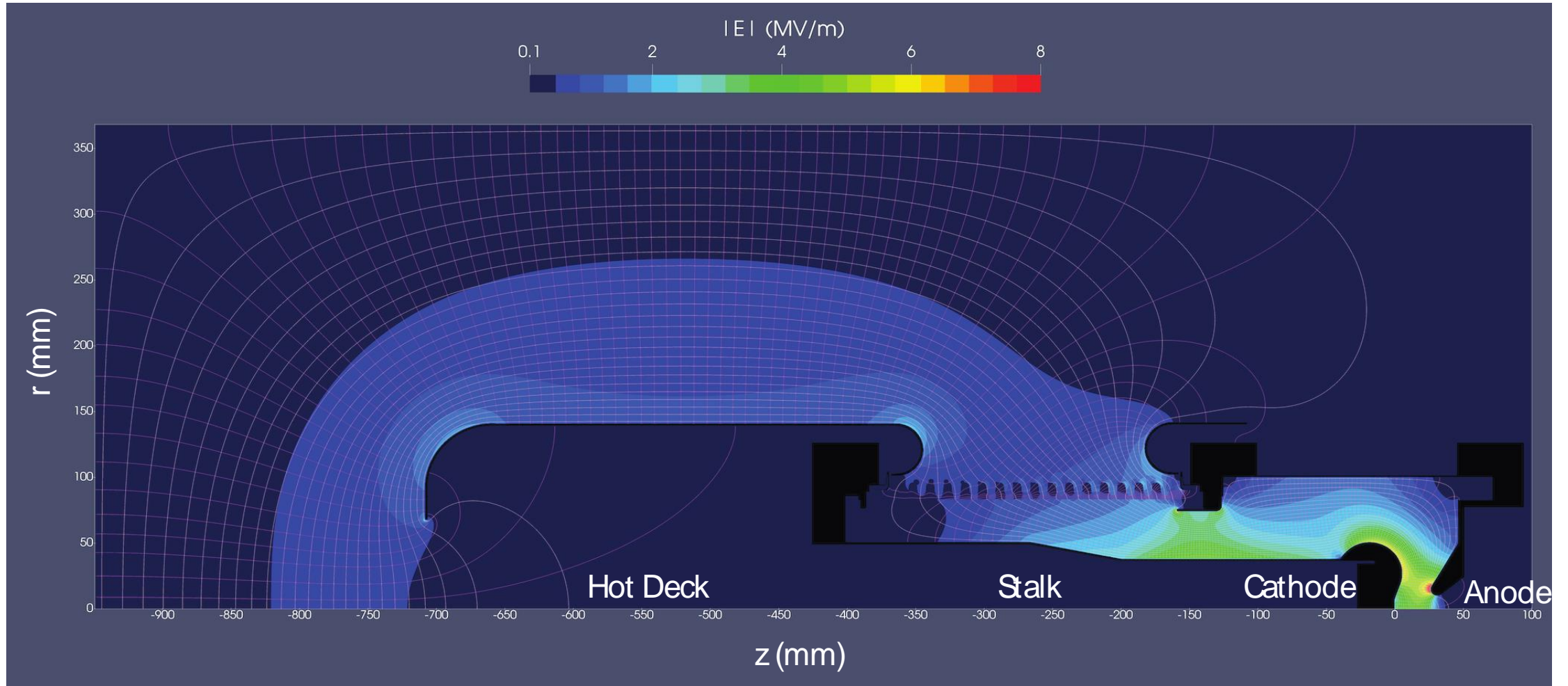

Poisson Convergence Study

Full Geometry

Cathode Detail

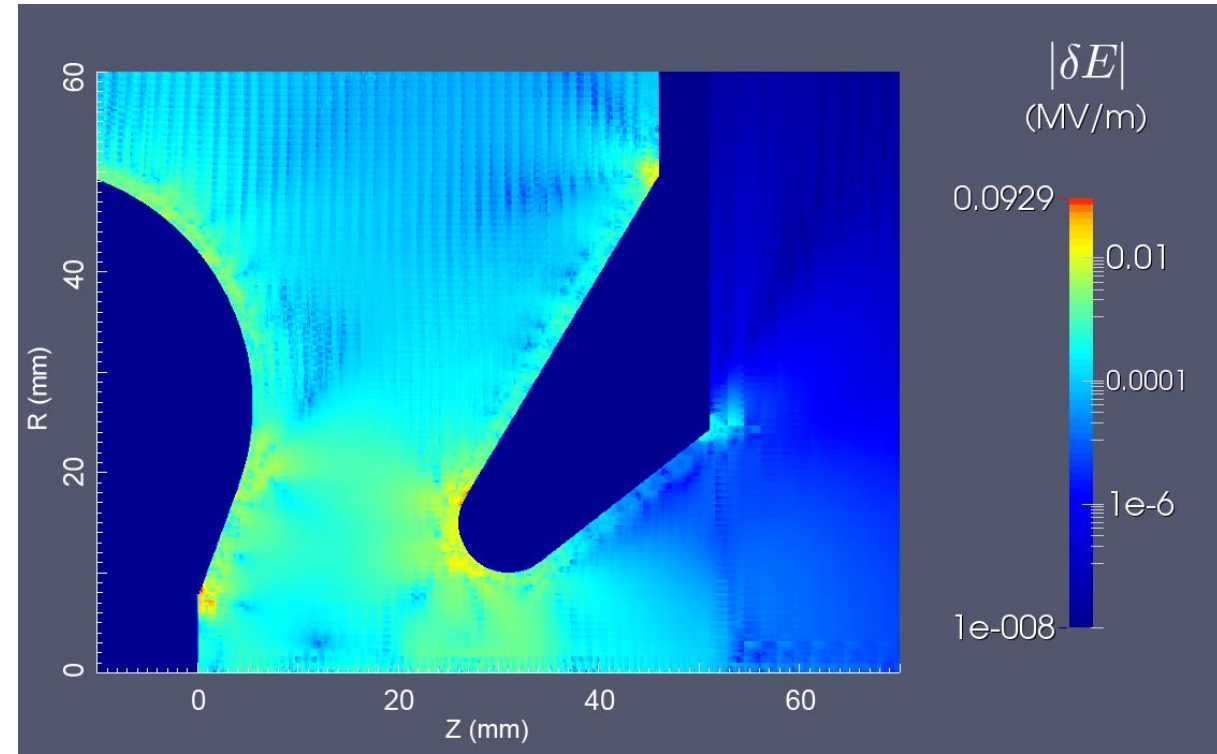
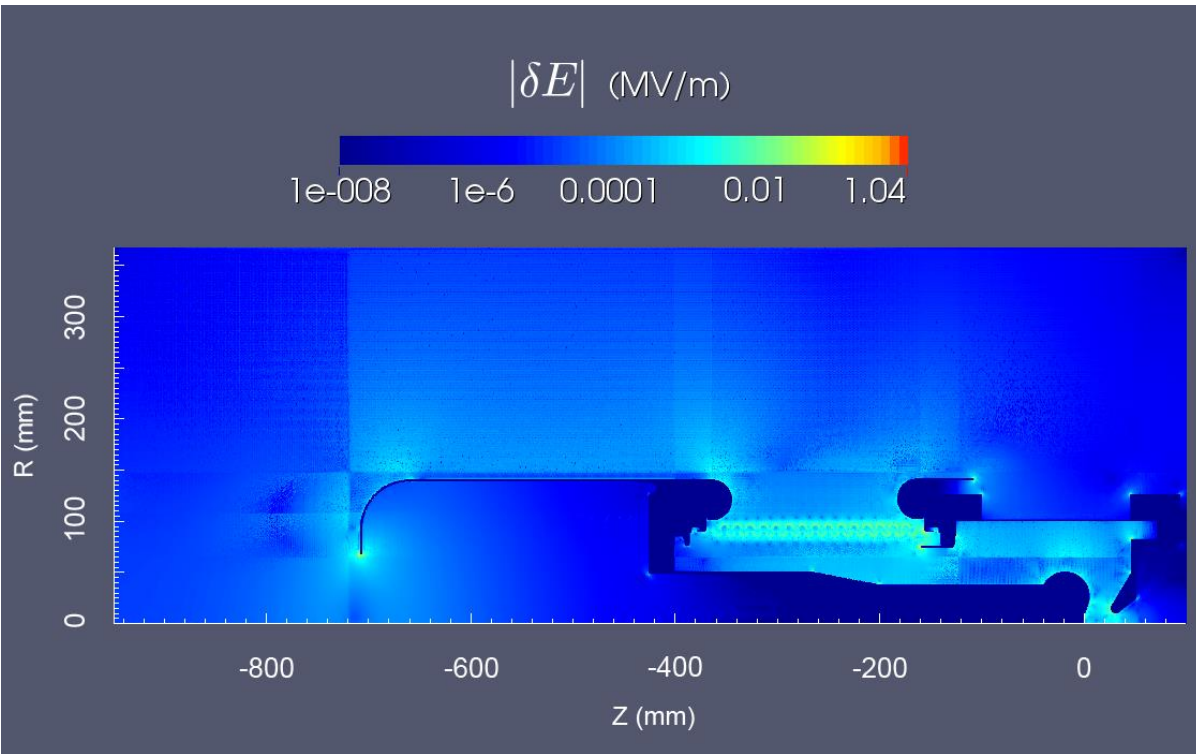



Physics design summary

RF Frequency: 500 MHz (subharmonic of 1500 MHz)

Cathode: CPI Y-845, $R = 0.4$ cm.

Nominal bunch charges: 20 pC, 130 pC

Cathode/Electrode geometry determined by Multi-Objective Genetic Optimization (MOGA):

- Gap = 26 mm,
- Cathode Angle 20 deg,
- Anode Angle = 31 deg

Emittance (~ 2 micron) preserved along 4 meters of GTS for a magnetized emittance of about 36 micron.

Vacuum System Mechanical Design

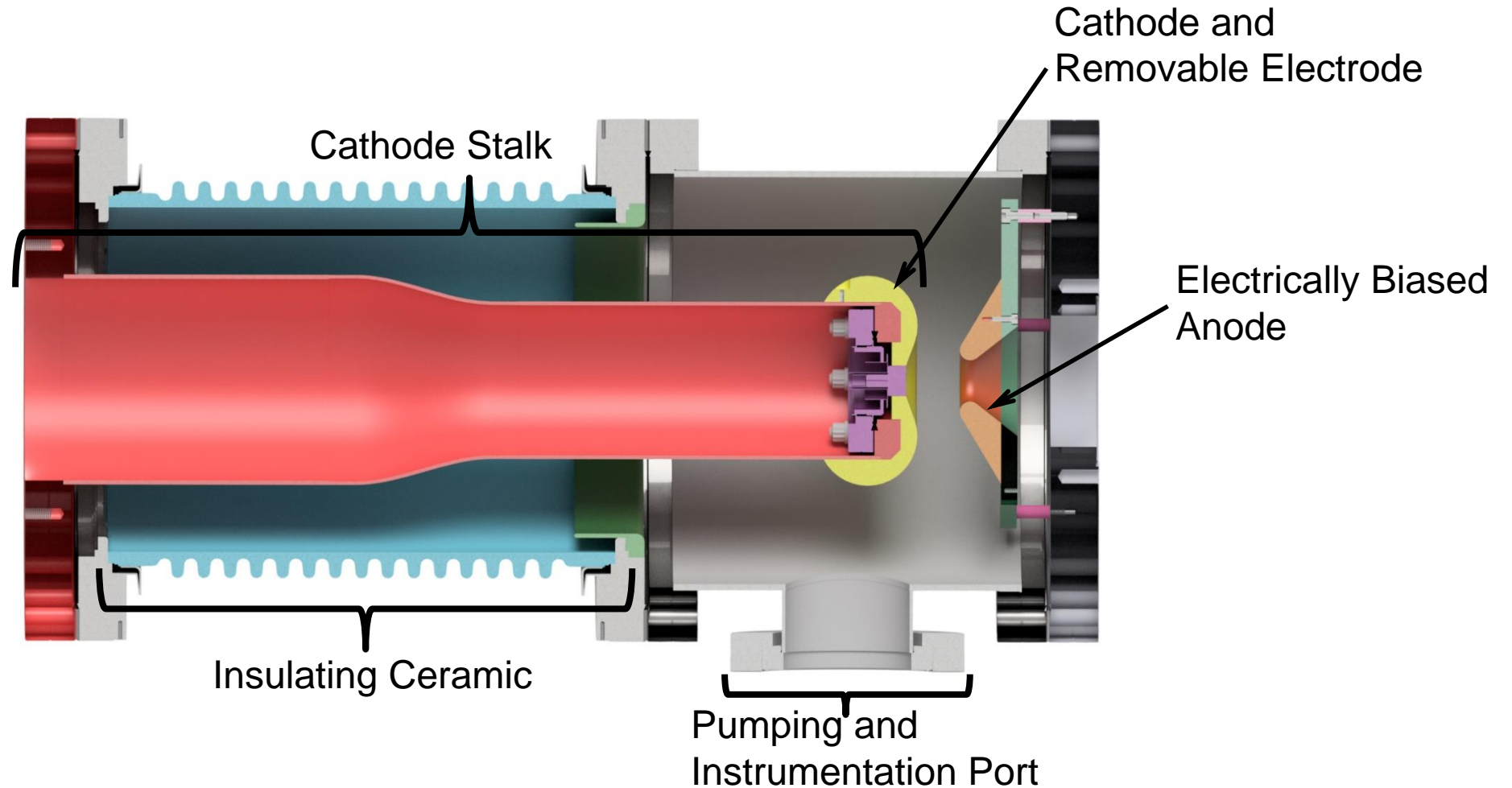



Cathode & Anode, Vacuum Chamber

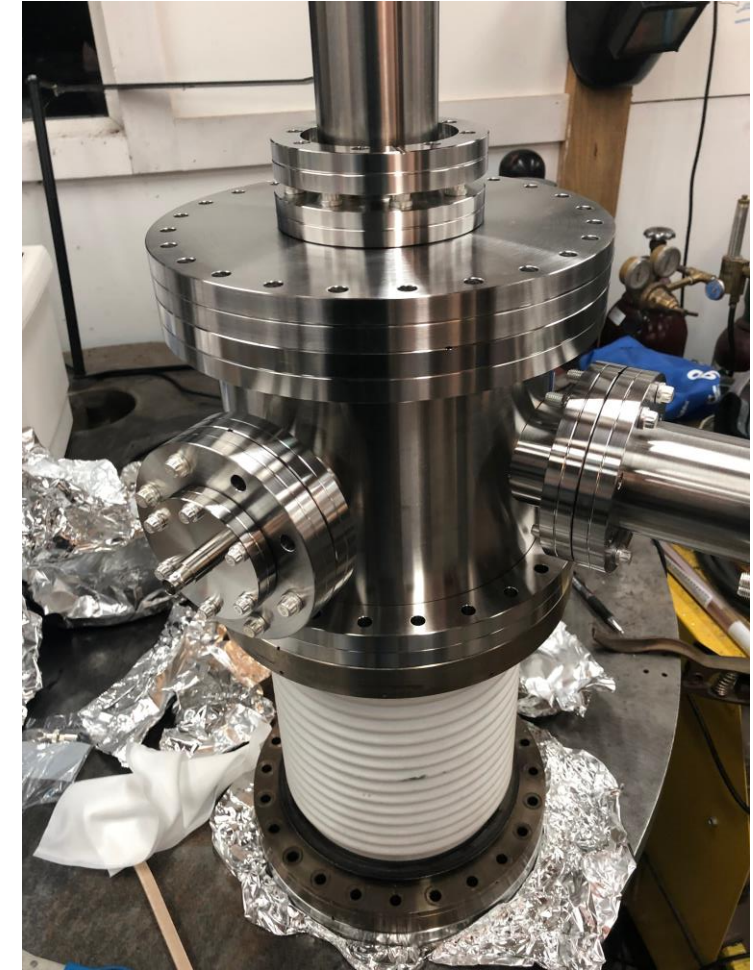
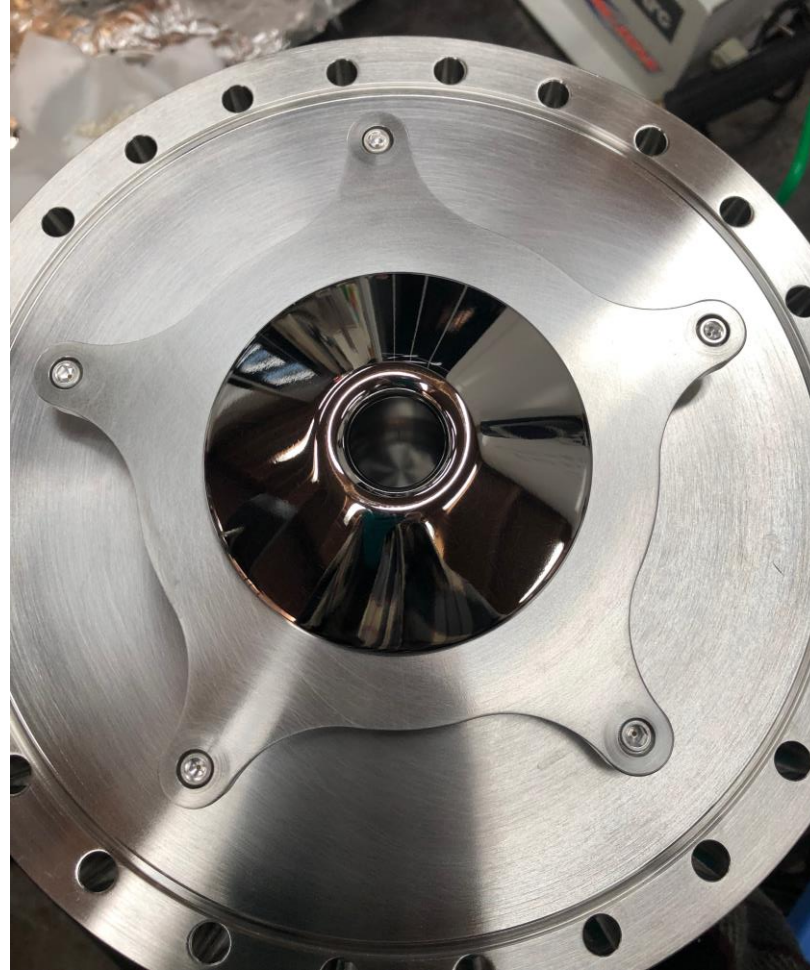

Full Gun Design

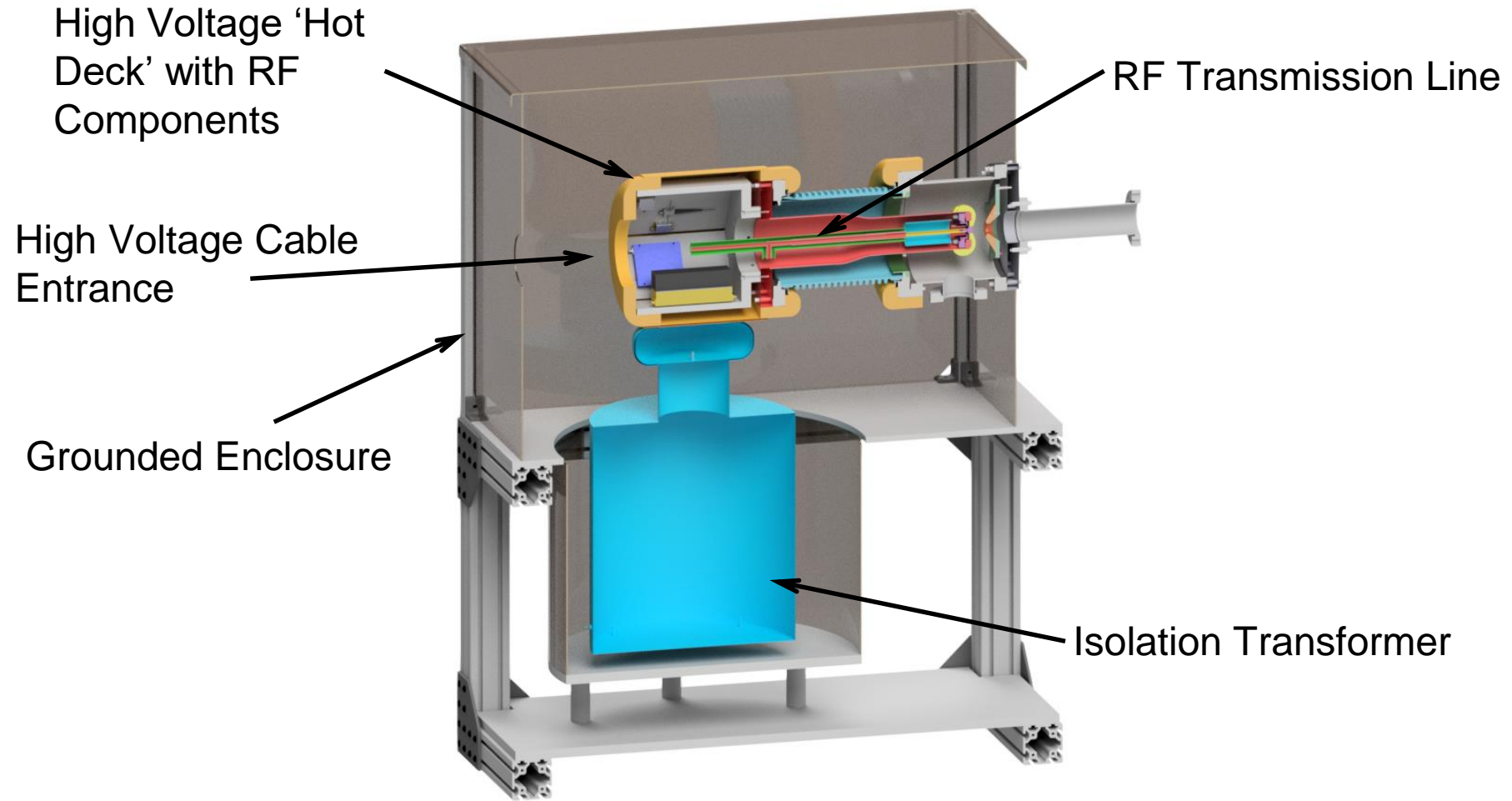

RF design

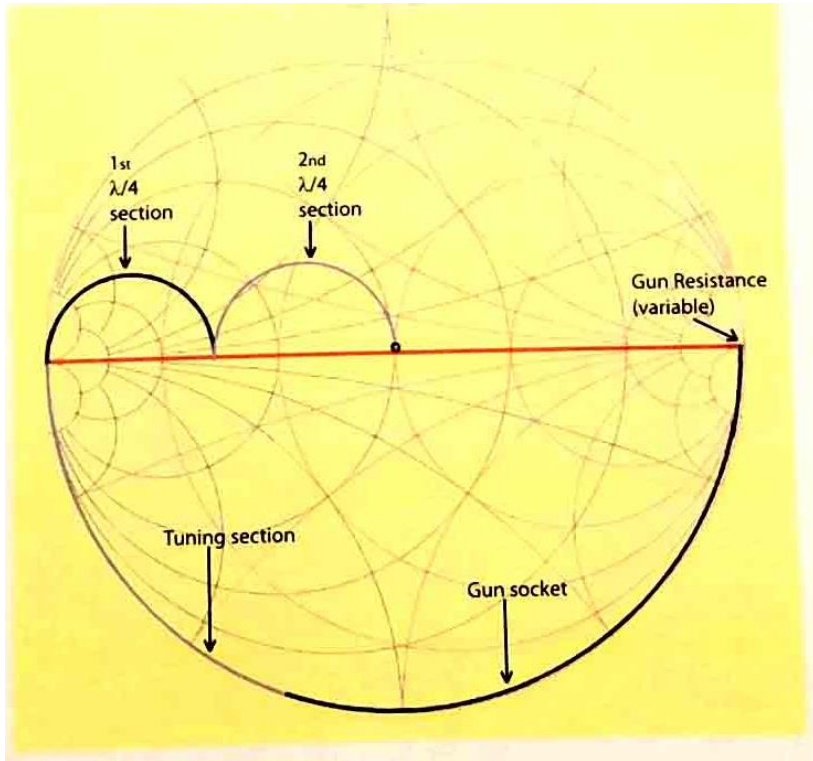

Based on TRIUMF design

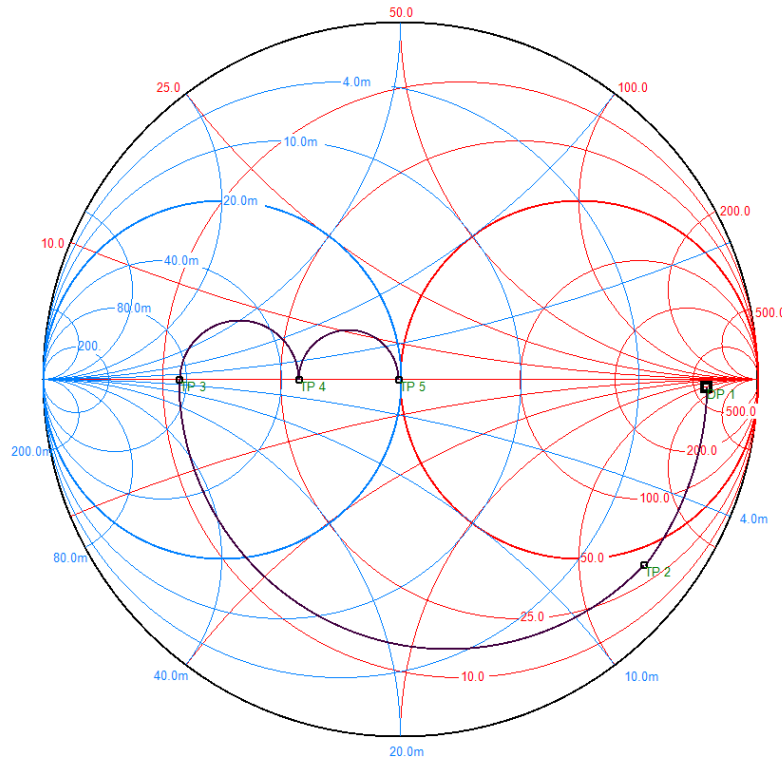

Xelera Tgun Impedance matching design, tunable



Back of Cathode as received

Cathode emission model

Cathode transconductance

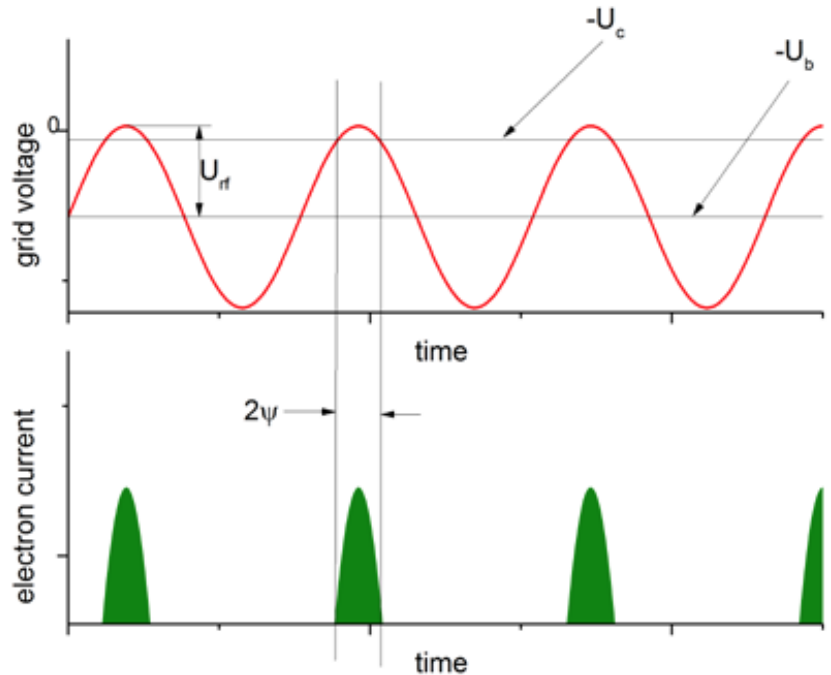

$$q_b = \frac{2g_{21}U_{rf}}{\omega} (\sin \psi - \psi \cos \psi)$$

$$I_b = \frac{g_{21}U_{rf}}{\pi} (\sin \psi - \psi \cos \psi)$$

$$\sigma_t \approx \psi / \omega \sqrt{5}$$

$$\sigma_t = \left(\frac{1}{q_b} \int_{-\psi/\omega}^{+\psi/\omega} t^2 I(t) dt \right)^{1/2} = \frac{1}{\omega \sqrt{3}} \left(\frac{2\psi^3 \cos \psi}{\sin \psi - \psi \cos \psi} + 3\psi^2 - 6 \right)^{1/2}$$



RF/ Cathode & Grid Drive Design

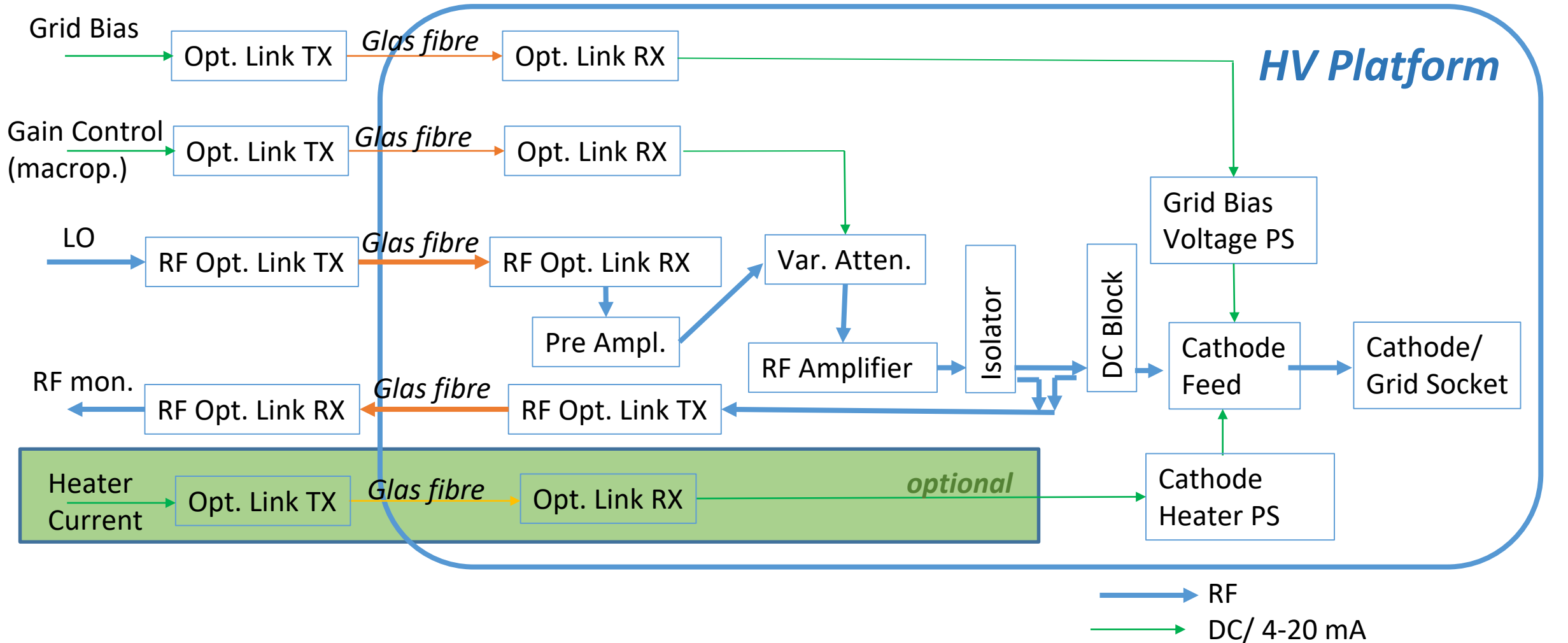

Hot Deck Electronics, RF Feed with tuner

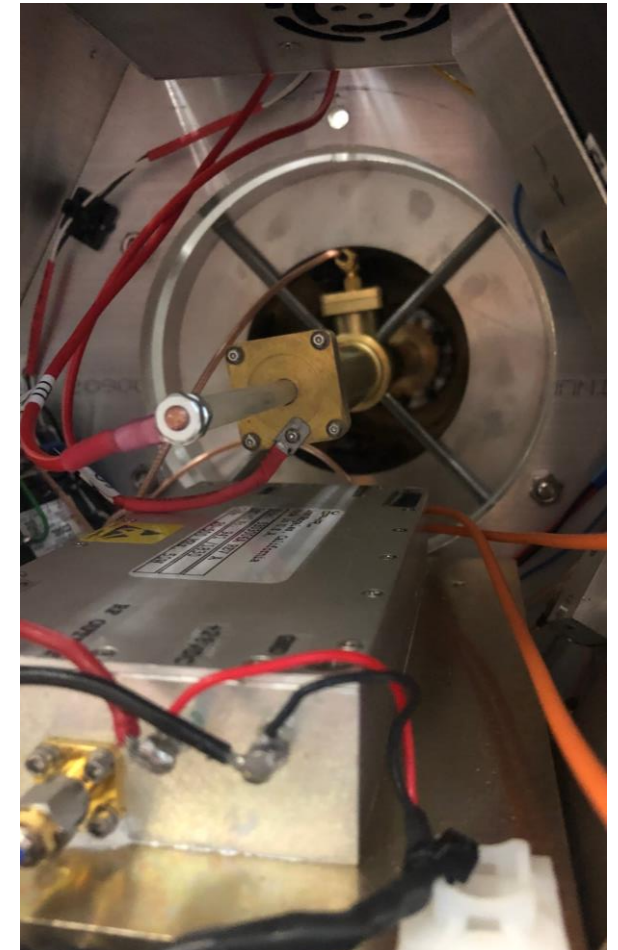
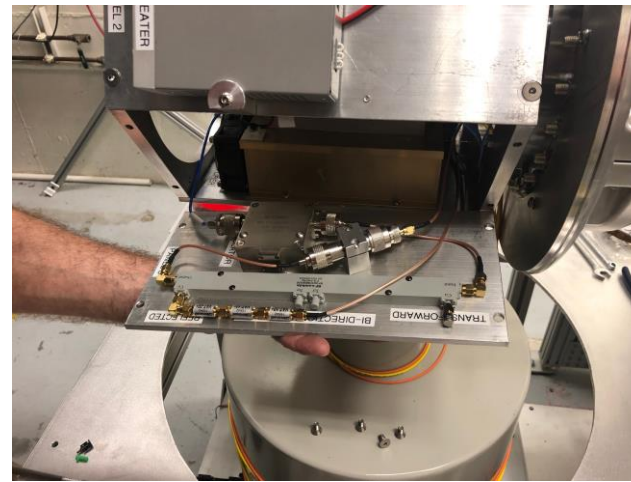
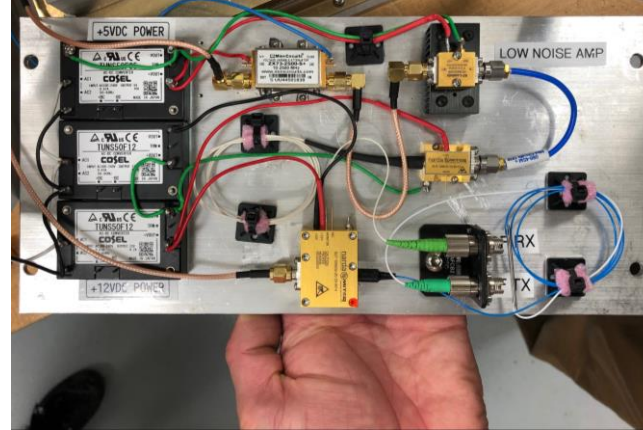
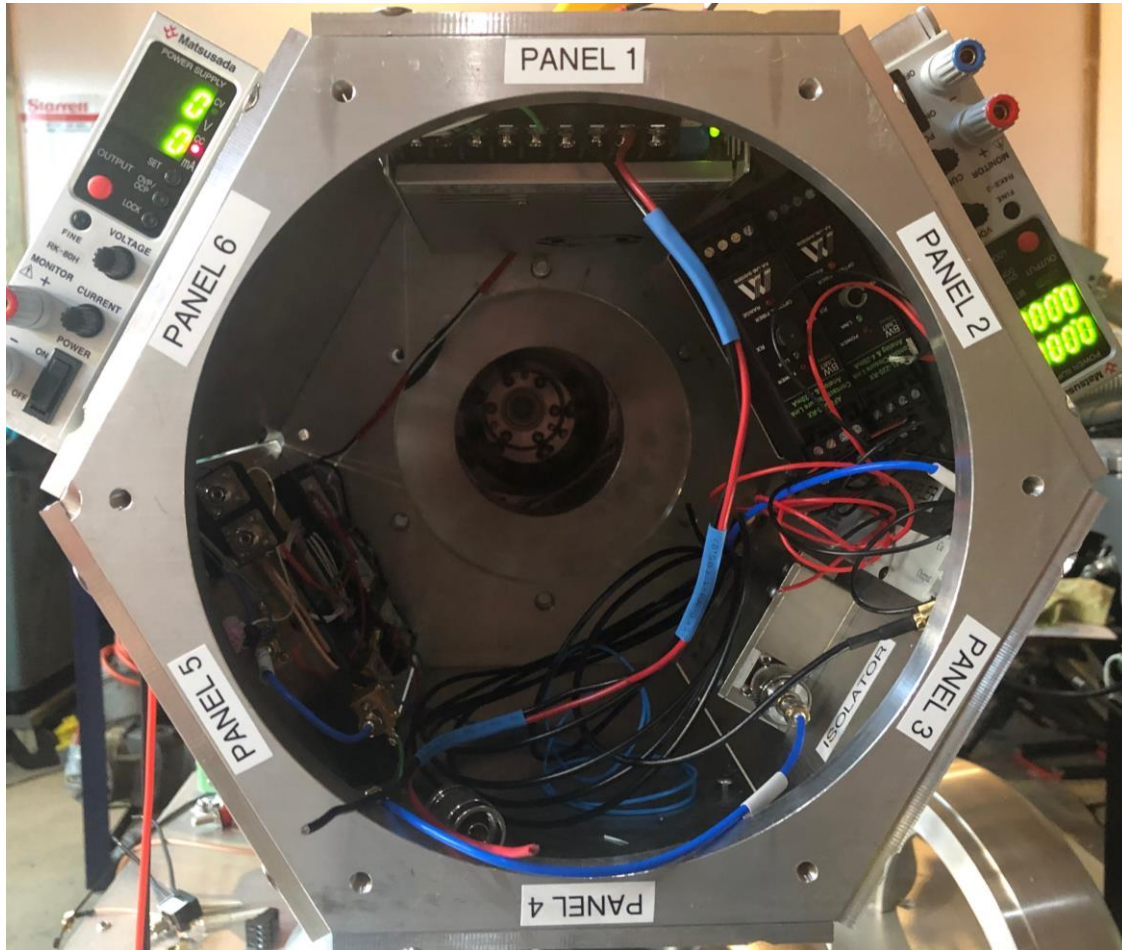

RF Feed





Racks

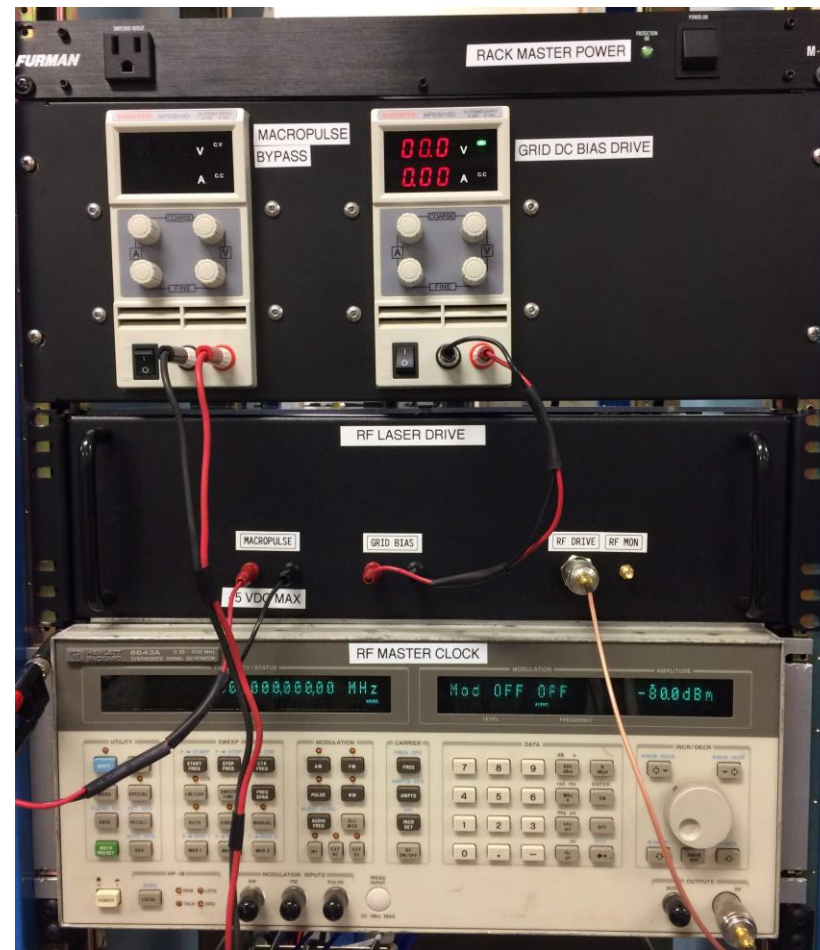



Testing at Xelera in Ithaca, NY

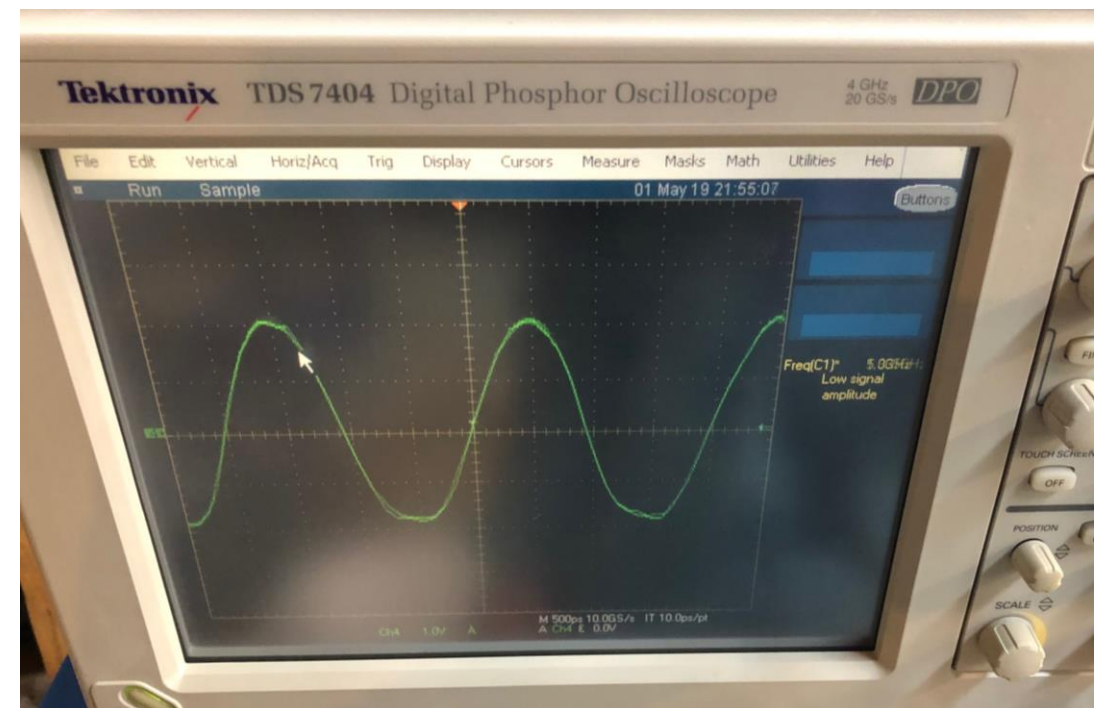
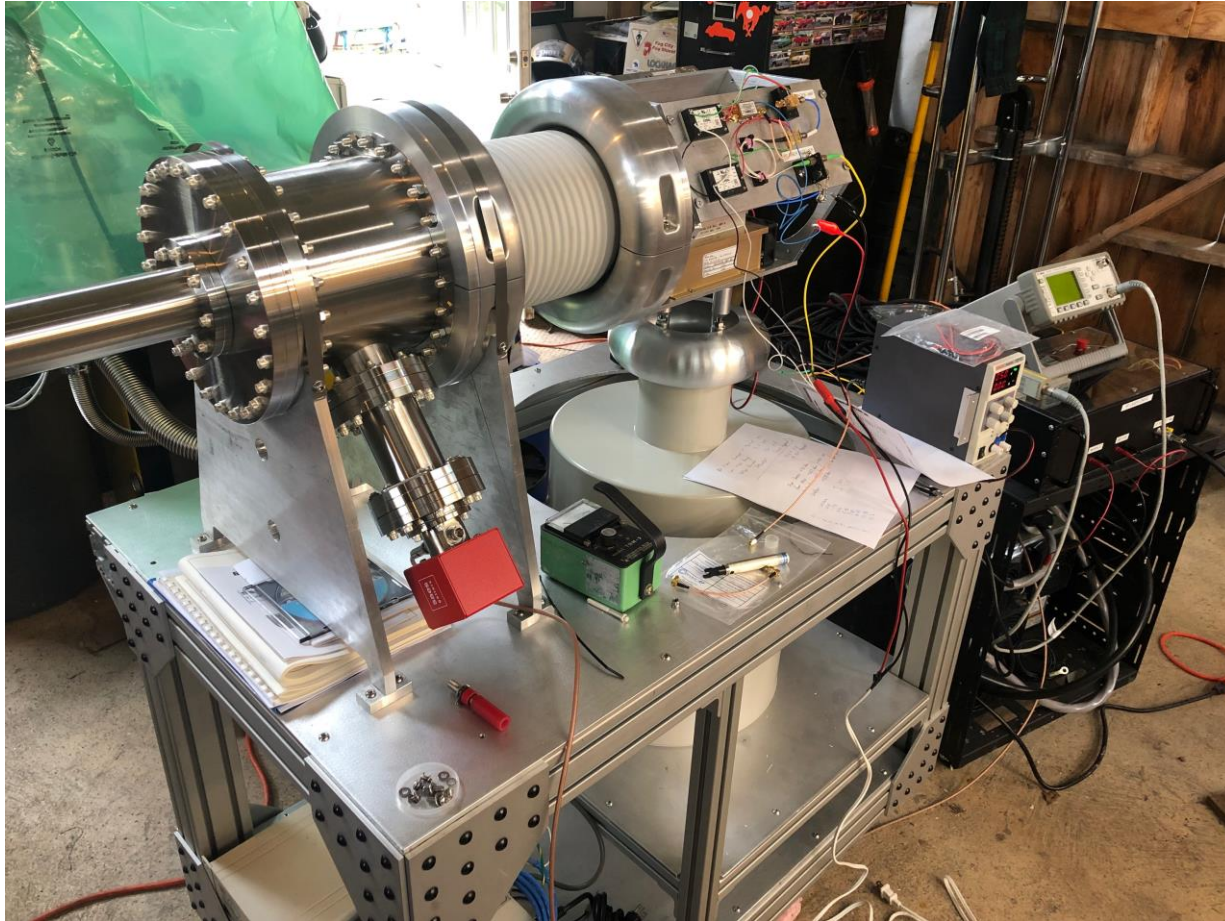

XELERA TGun in JLAB GTS Beamline

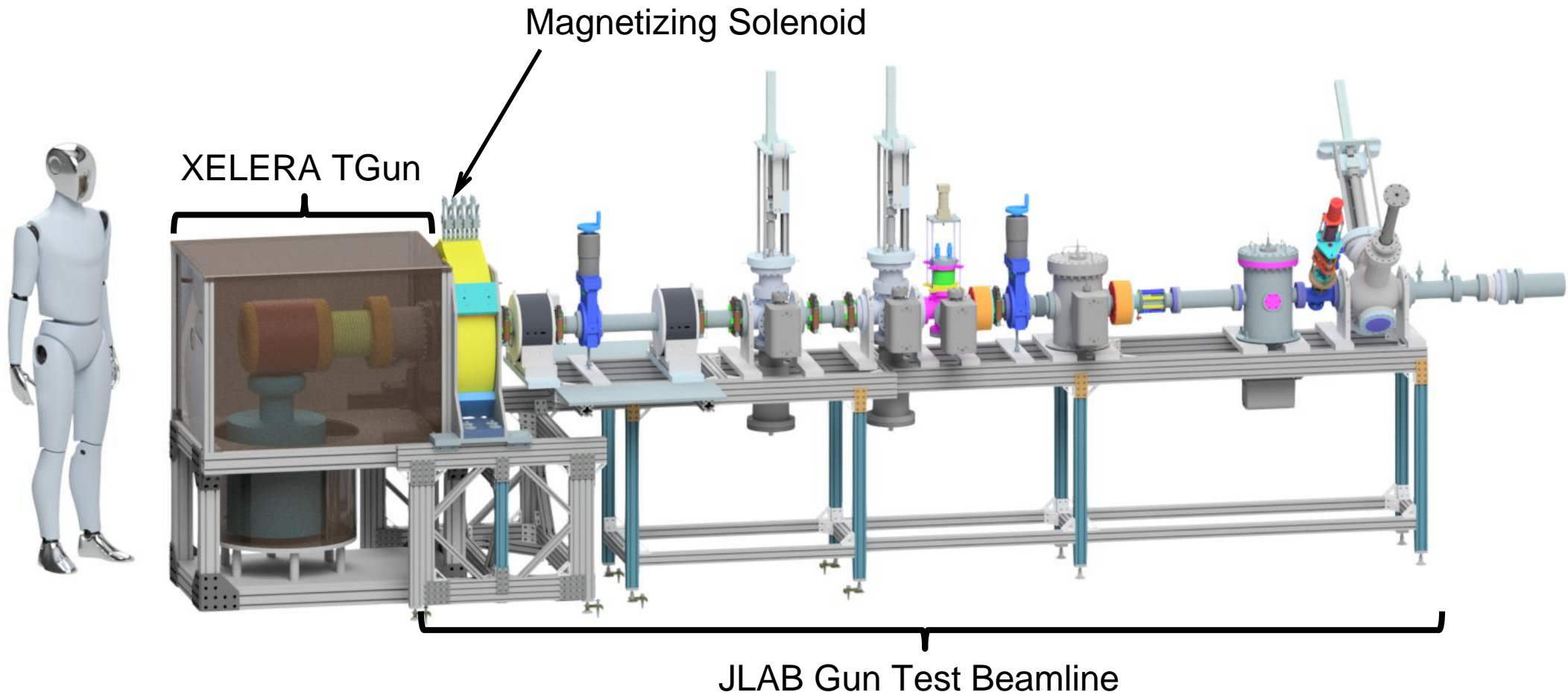



Delivery and Installation at JLab (July 1, 2019)

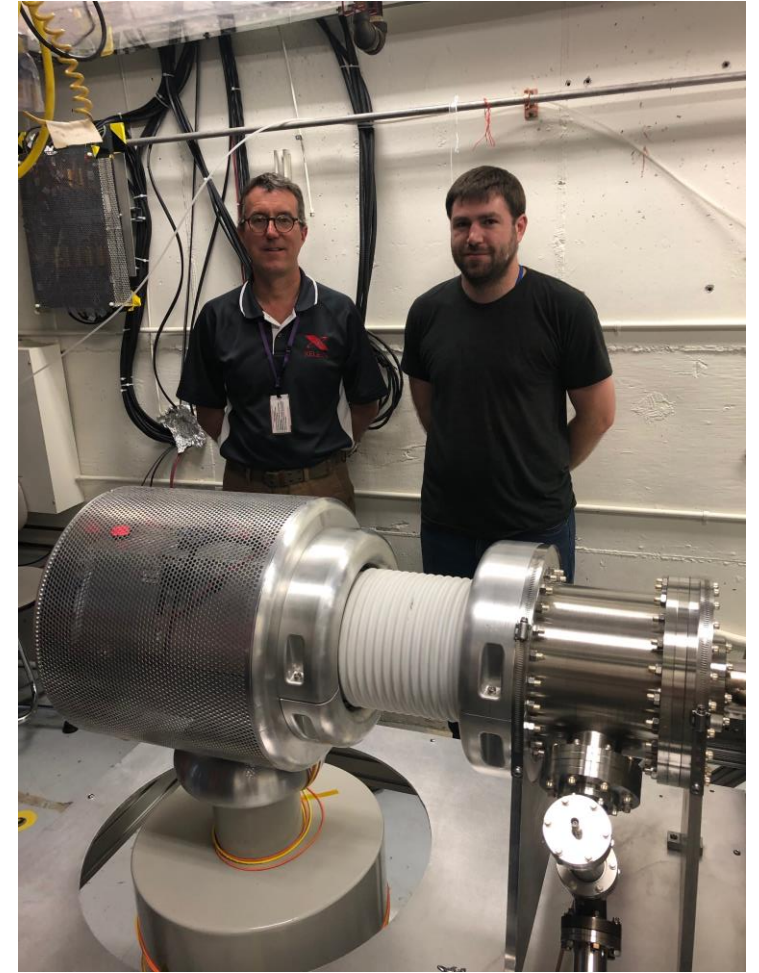
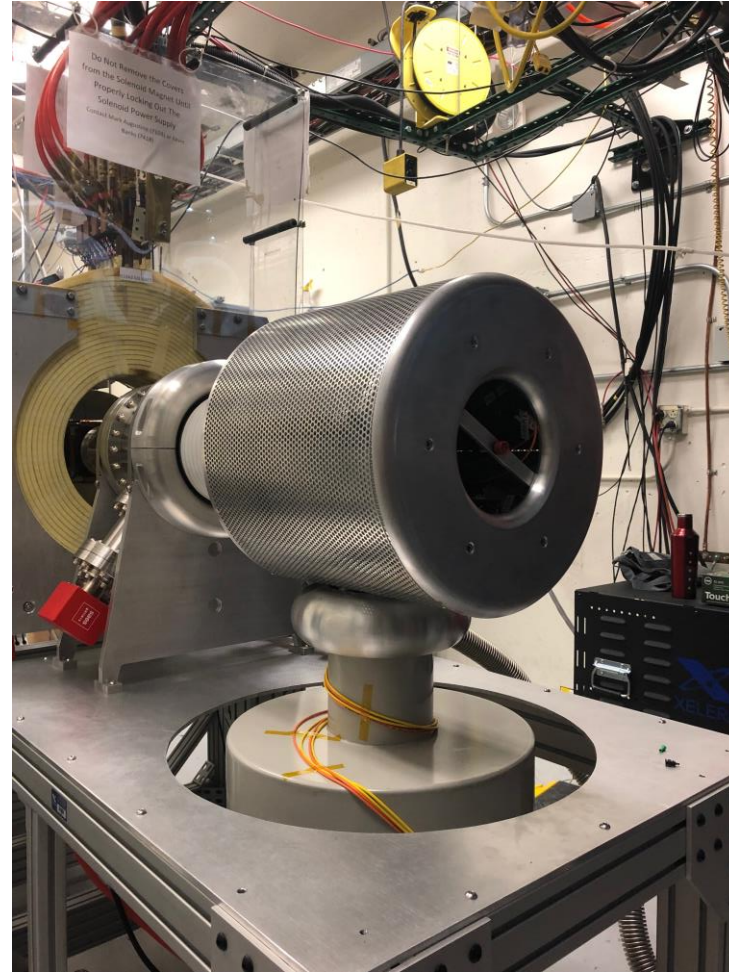



Testing in JLab's Gun Test Stand

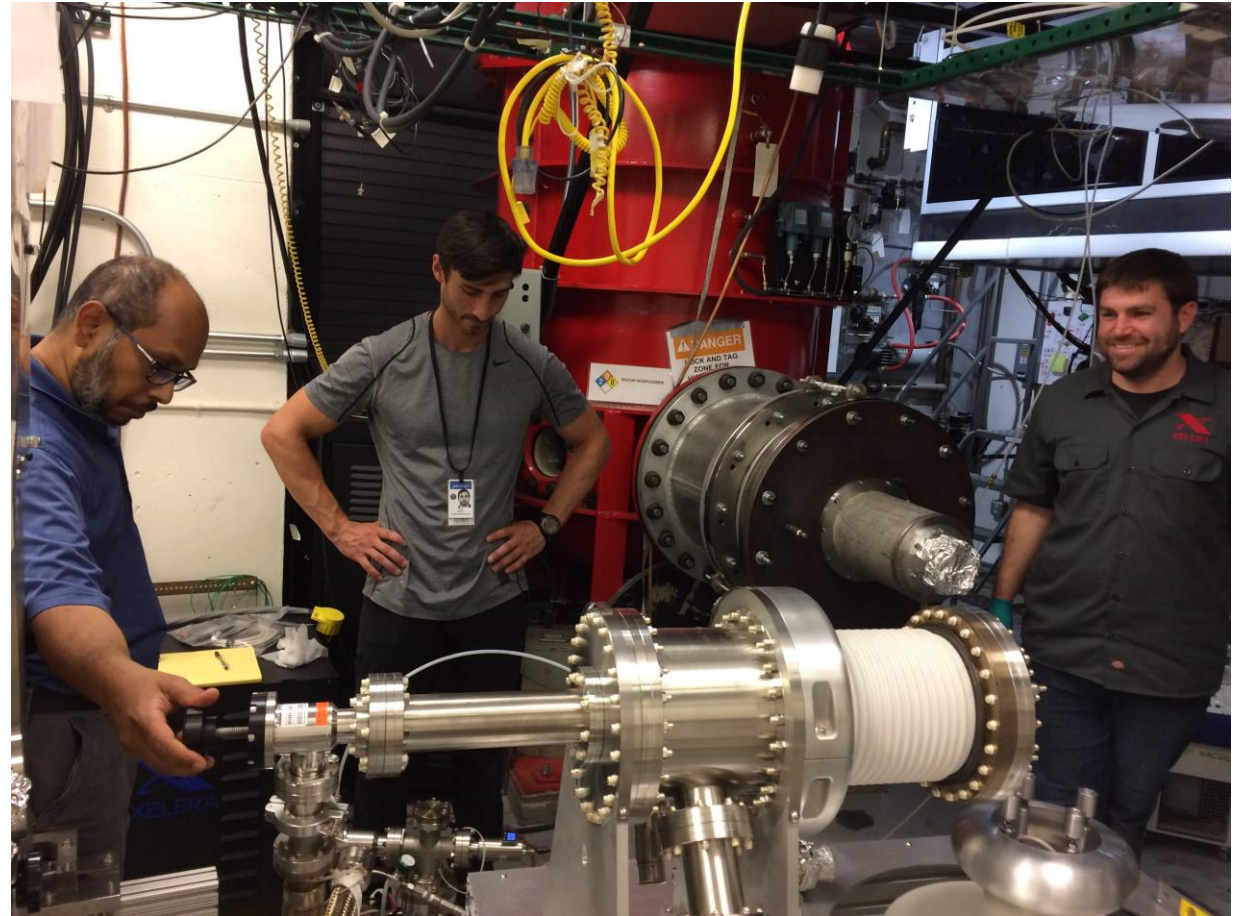



Possible Phase IIB, Phase III Continuation

Table 2.1: Electron source parameters for the existing Phase II project, this Phase IIB proposal, and a potential Phase III commercial item that satisfies the needs of the JLEIC electron cooler.

Parameter	Phase II	Phase IIB	(Phase III)	Unit
Voltage	100	350	450	kV
Bunch Charge	0.100	3.2	3.2	nC
frequency	500	43.3	43.3	MHz
Duty Factor	100	5	100	%
Max Average Current	50	7	130	mA
Magnetized (drift) emittance	< 36	< 36	< 36	μm
Thermal emittance	< 10	< 19	< 19	μm



Summary

- Xelera formed from the former Cornell ERL team in 2013.
 - In house developed highly parallel cloud-based software tools for accelerator optimization and design.
 - Mechanical design and fabrication expertise: including cleanroom, vacuum lab, and machine shop for low volume manufacture.
 - Phase I: Design studies and optimizations for a magnetized injector (complete).
 - Phase II: Build a prototype Thermionic gun (Tgun) to produce a magnetized beam.
 - Specifications and design developed in close collaboration with JLab injector group.
 - Fabrication complete, delivered to JLab.
 - Xelera Tgun is now installed in Jlab's GTS for characterization.
 - Working with JLab on a 350 kV design for high bunch charges (3 nC)
-

