

The Relativistic Heavy Ion Collider Facility and the SBIR/STTR Program

Qiong Wu

DOE-NP SBIR/STTR Exchange Meeting

Gaithersburg MD, 8-9 August 2017

70 YEARS OF
DISCOVERY

A CENTURY OF SERVICE



Contents

- The Relativistic Heavy Ion Collider (RHIC) Accelerator Complex
 - The machine
 - The experiments and upgrades
 - Why outreach to industries
- Looking into the future – eRHIC
 - What are our challenges
- Summary

Th

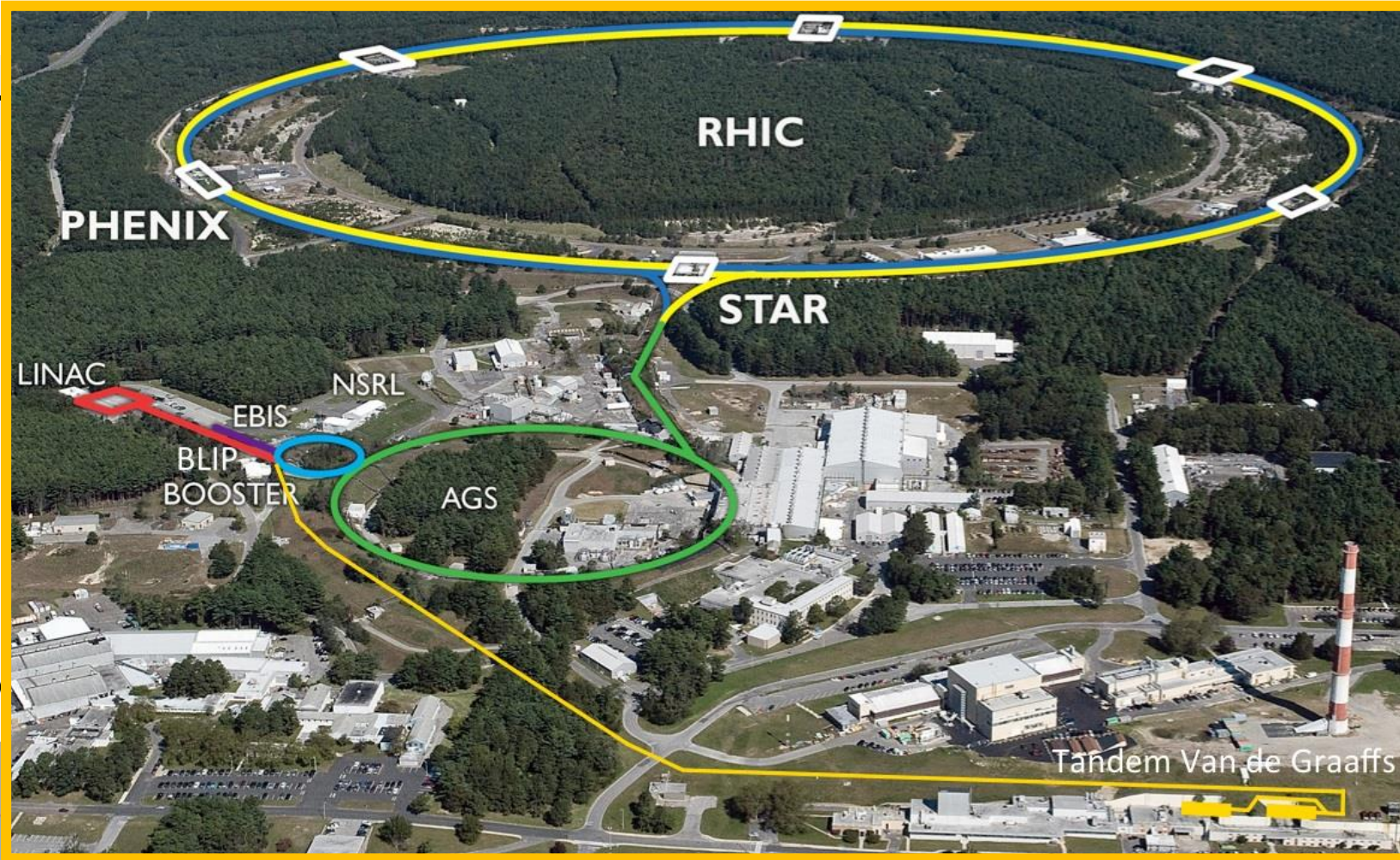

Ca
WV



70 YEARS OF
DISCOVERY
A CENTURY OF SERVICE

The RHIC

Relativistic Heavy Ion Collider

1 of 2 ion colliders (other is LHC), only polarized p-p collider

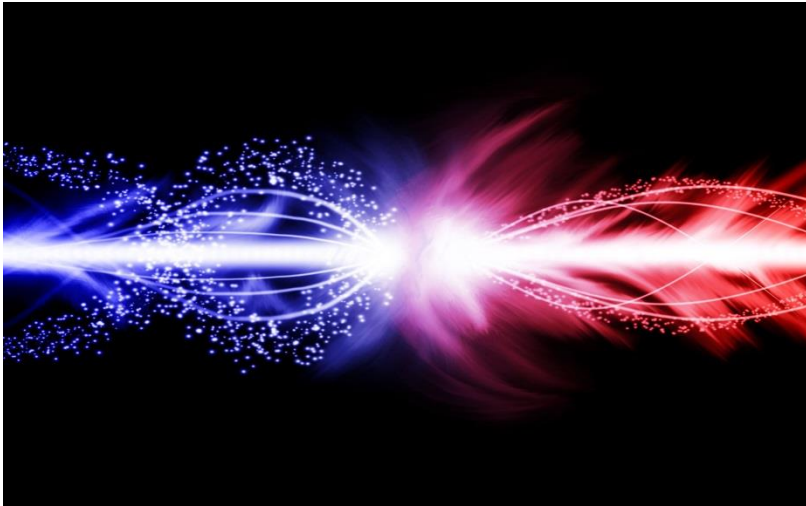

2 superconducting 3.8 km rings
2 large experiments

100 GeV/nucleon ions up to Uranium
255 GeV polarized protons

Performance defined by

1. Luminosity L
2. Proton polarization P
3. Versatility (species, E)

At RHIC, physicists from around the world study **what the universe may have looked like in the first few moments after its creation**. What scientists learn from RHIC may help us understand more about **why the physical world works the way it does**, from the smallest subatomic particles, to the largest stars.

Highlights on this complex

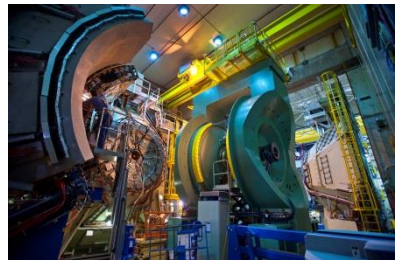

PHENIX



STAR



Superconducting magnet



EBIS

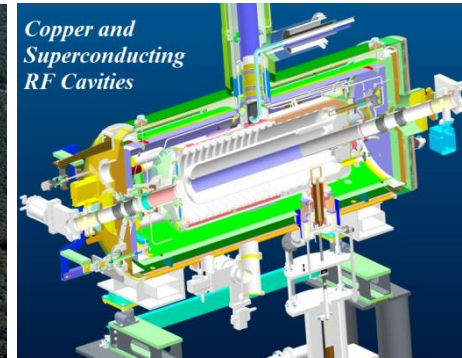
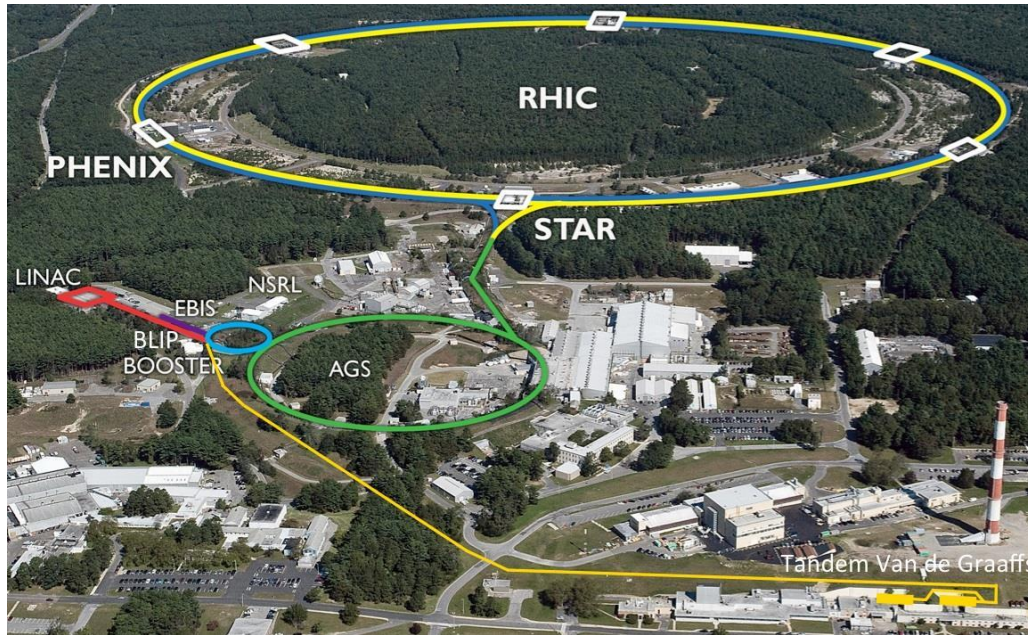

Copper and Superconducting RF Cavities



BLIP



Tandem Van de Graaffs



BNL



NSRL



5

LINAC



Electron Beam Ion Source (EBIS)

The 15 Species provided by EBIS up to date to different experiments:

- He-3 2+ AGS
- He-4 1+, 2+ NSRL
- C 5+ NSRL
- O 6+ NSRL
- Ne 5+ NSRL
- Si 11+ NSRL
- Ar 11+ NSRL
- Ti 18+ NSRL
- Fe 20+ NSRL
- Cu 11+ RHIC
- Kr 18+ NSRL
- Xe 27+ NSRL
- Ta 38+ NSRL
- Au 32+ RHIC & NSRL
- U 39+ RHIC

EBIS is a "charge breeder" of the injected 1+ ions

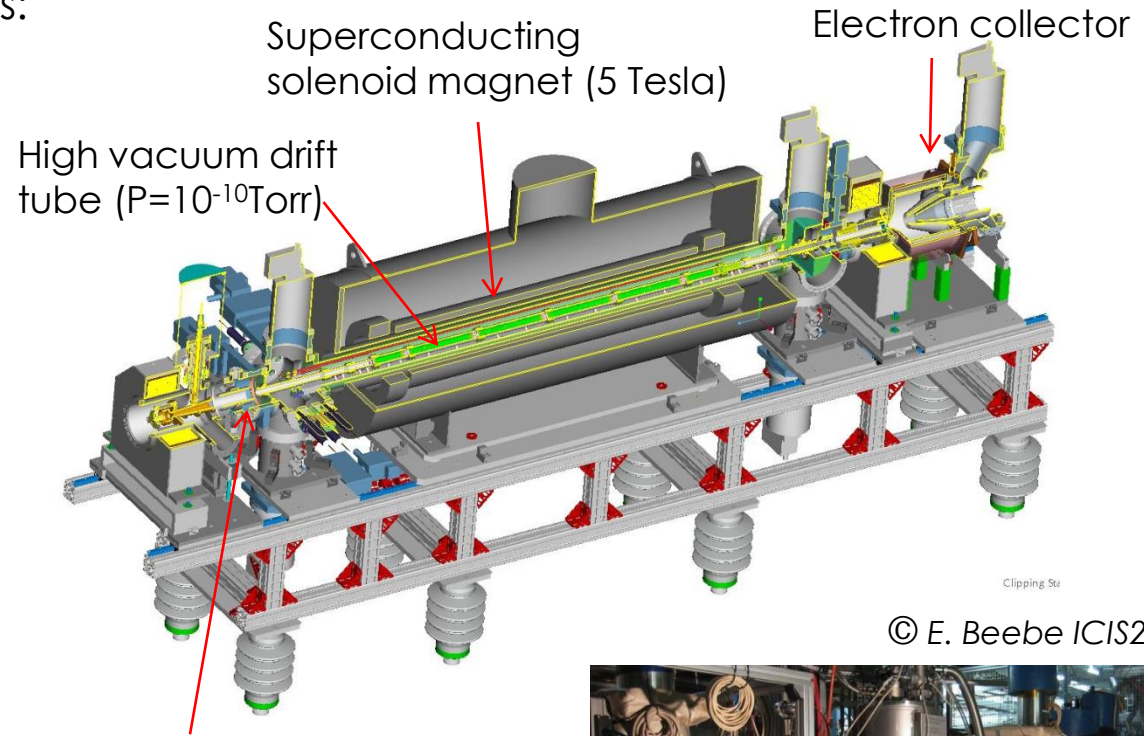

Clipping Size

© E. Beebe ICIS2013



Hollow cathode ion source



BNL LINAC Isotope Producer (BLIP)

- First to use a high energy proton accelerator to produce isotopes (1972)
- BLIP utilizes the beam from the proton linac injector for the Booster, AGS, and RHIC accelerator (nuclear physics).
- Excess pulses (~90%) are diverted to BLIP. Energy is incrementally variable from 66-202 MeV.
- The BLIP beam line directs protons up to 165 μ A intensity to targets; synergistic operation with nuclear physics programs for more cost effective isotope production.
- Implemented beam rastering and increasing linac current to increase isotope production capabilities.

*Courtesy of C. Cutler.
See more in E. Balkin's talk later today*



Isotope	Half-life	Typical application
Be-7	53.3d	γ source
Fe-52	8.3h	Iron tracer, hematology
Zn-65	244d	Zn tracer
Cu-67	61.9h	Radioimmunotherapy
Ge-68/Ga-68	271d/68m	PET calibration
As-72	26h	PET imaging
Sr-82/Rb-82	5.4d/75s	PET studies of heart
Y-86	14.7h	PET imaging prior to Y-90 therapy
Ac-225	10d	Radioimmunotherapy



70 YEARS OF
DISCOVERY
A CENTURY OF SERVICE

Copper and Superconducting Cavities

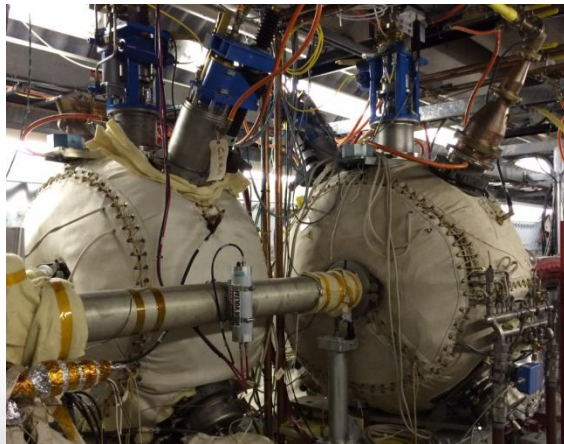
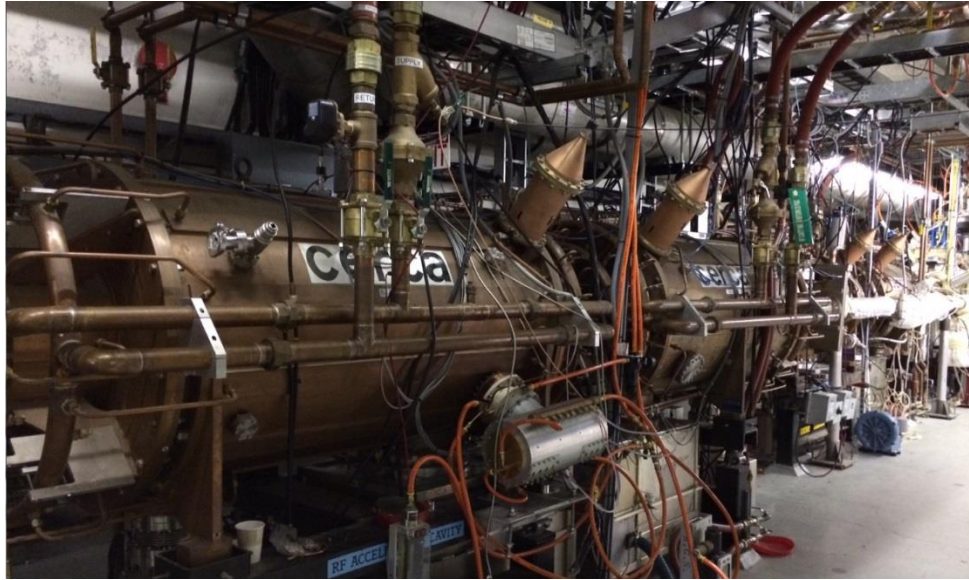

- **Two** accelerating copper cavities per ring at 28 MHz (top left).
- **Five** bunching copper cavities per ring at 197 MHz (left).
- **One** 'bouncer' copper cavity shared by both rings at the common section at 9 MHz.
- **One** storage Nb superconducting RF cavity at 56 MHz was added in common section in 2014 (right pictures).

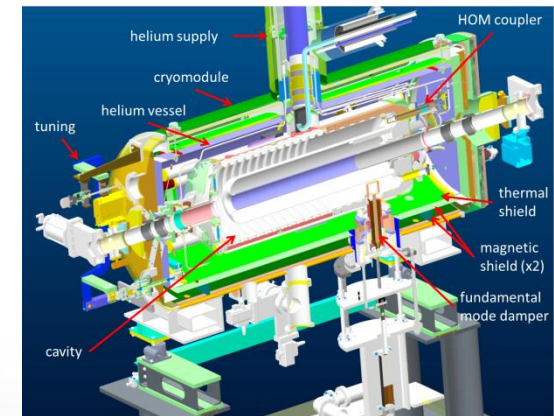

Superconducting Magnet

dipole

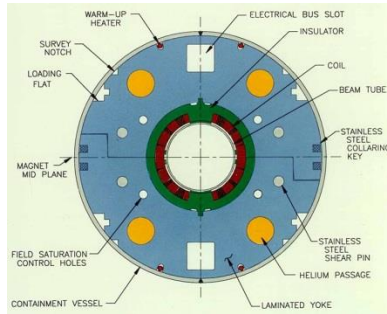

quadrupole

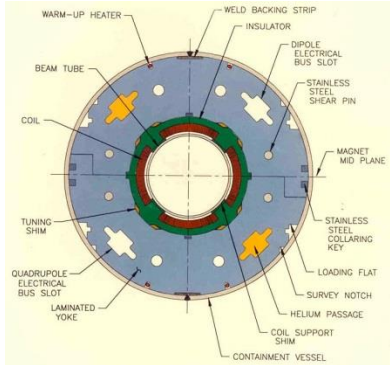

sextupole

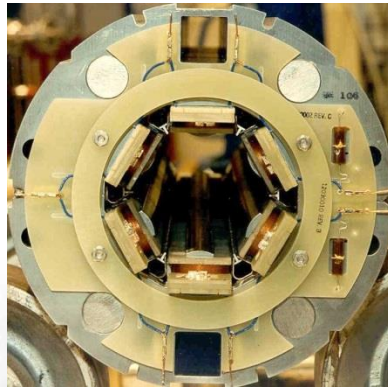

From the Superconducting Magnet Division website:

- The Superconducting Magnet Division supplied 1740 magnetic elements, in 888 cryostats, for the RHIC facility at BNL.
- Of these, 780 magnetic elements were manufactured by Northrop-Grumman (Bethpage, NY) and 360 were made by Everson Electric (Bethlehem, PA).
- The magnets made in industry used designs developed at BNL.
- The first cooldown of the magnets for the RHIC engineering run was in 1999. Since then, the magnets have operated very reliably.

Planned Accelerator Experiments/Upgrades



CeC



LEReC

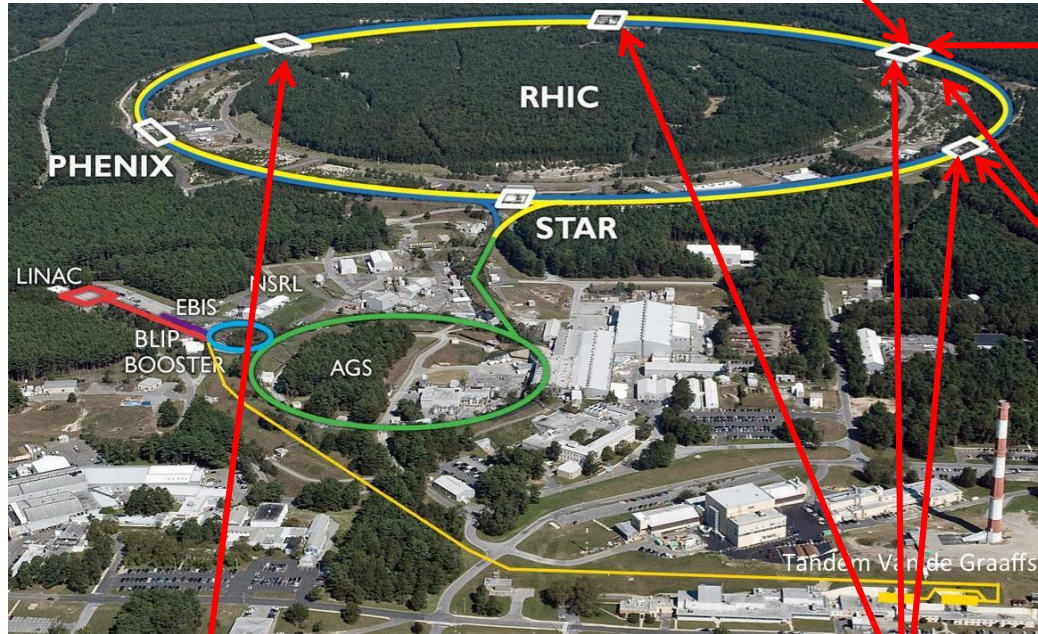

Superconducting RF technology

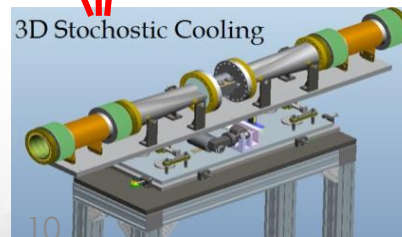
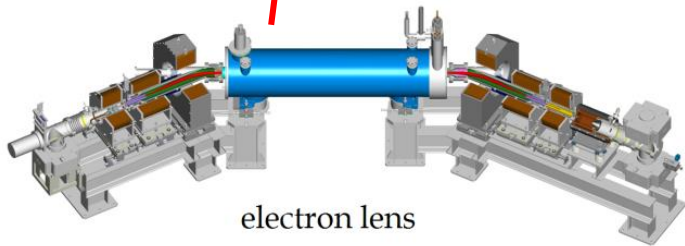

3D Stochastic Cooling (Completed)

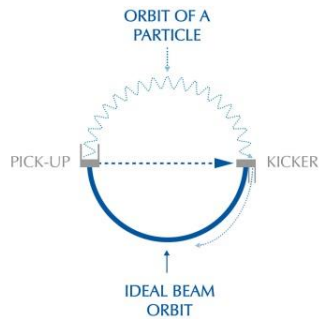

- Cooling is enforcing order among the particles with external interference.
- The ideal cooling prefers the detection and correction of individual particles.
- The compromise is to slice the ion bunches, then detect and correct the offset of each slice individually.
- The detection device is the pick-up, and the correction device is the kicker. They together with the link between them must be broad band for fine slicing, hence faster cooling.
- In RHIC, we can correct the slices in 6D (in both longitudinal and transverse coordinates)
- Challenges:
 - Fast signal pick-up and response
 - Broadband communication (70 GHz)
 - Reliable motion



longitudinal



transverse



Electron Lens

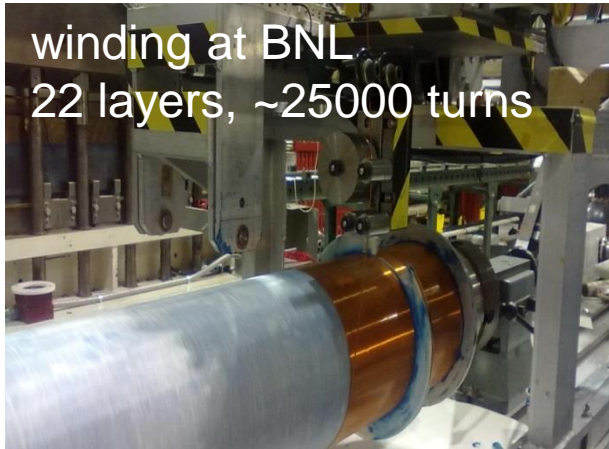

winding at BNL
22 layers, ~25000 turns

6 T superconducting solenoid

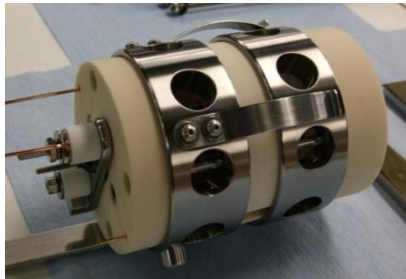

Thermionic cathode

Electron back scattering detector

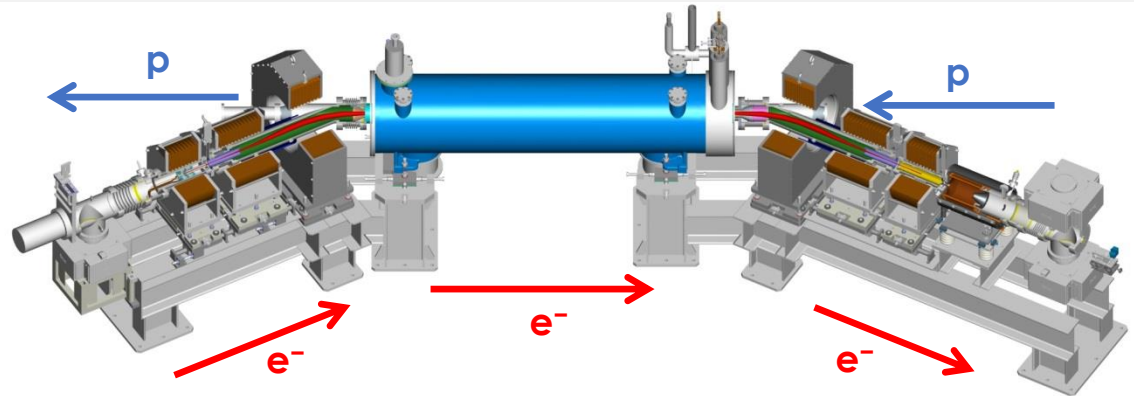
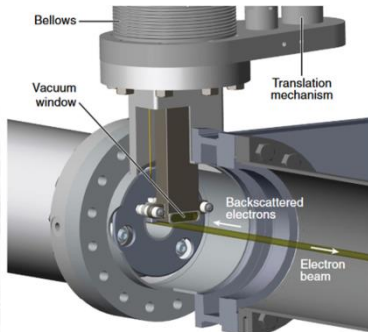

© X. Gu, *The 57th ICFA Advanced Beam Dynamics Workshop on High-Intensity and High-Brightness Hadron Beams*

- Introduce electron beam into each ring to collide head-on with the proton beam to provide tune spread compensation at high beam intensities. This will increase the luminosity and lifetime of the proton run.
- Two electron lenses are installed near IP10.
- Each e-lens is about 2.5 meters long. The effective interaction region is 2.0 m.
- e-lens for Blue (Yellow) beam allows bunch intensity increase in Yellow (Blue) beam.
- Challenges:
 - High magnetic field (6 T) operation superconducting wiring
 - Large thermionic cathode with high DC current (1A)
 - Beam detection system for alignment

Low Energy RHIC electron Cooling (LEReC)

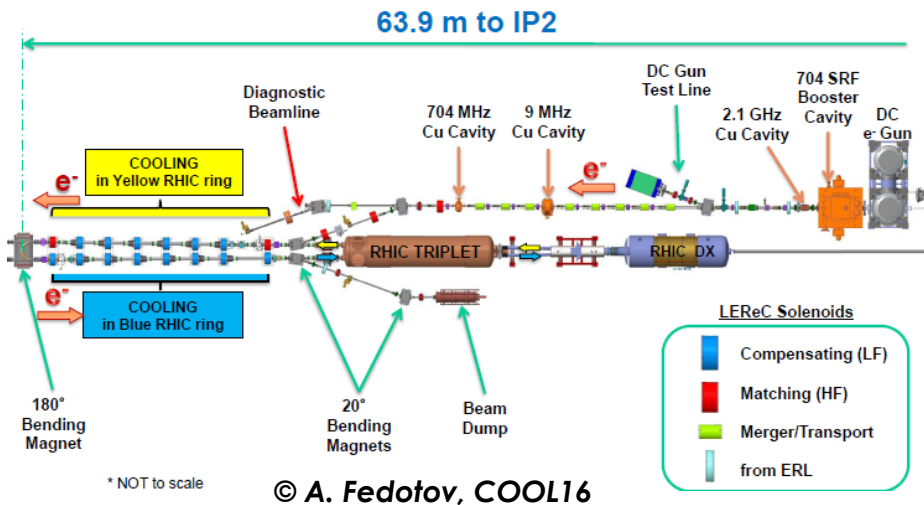

solenoid

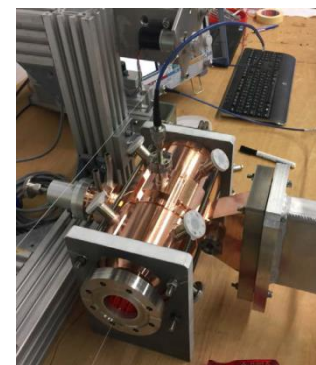
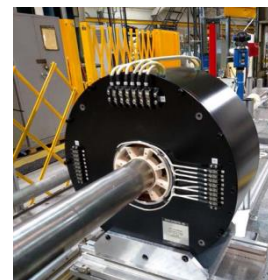

2.1 GHz Cu cavity



DC gun

- Low energy nuclear physics study is under construction at RHIC
- Significant luminosity improvement can be provided with electron cooling applied directly in RHIC at low energies
- “Cold” electron beam (<5 MeV) is merged with ion beam which is cooled through Coulomb interactions, which will be renewed after single turn.
- Challenges:
 - High average electron current (50 mA)
 - High accuracy machining (cavities)
 - Superconducting technology
 - Large frequency change of RF cavity (>10%)



9 MHz Cu cavity

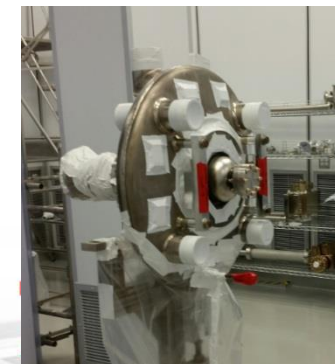

704 MHz SC cavity

Coherent electron Cooling (CeC) - Proof of Principle

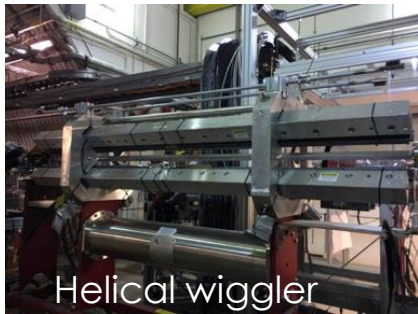

CsK₂Sb
photocathode

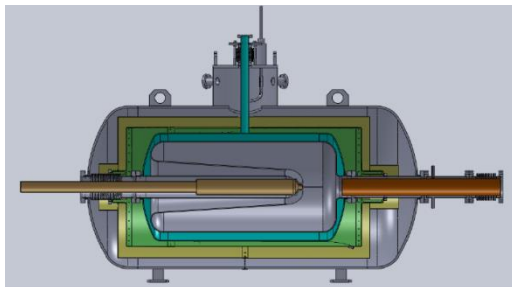

112 MHz SC electron gun



5-cell 704 MHz SC Cavity

- Coherent electron Cooling imprints the imperfection of the proton beam into the electron beam by first direction interaction. The second interaction between the two beams corrects the proton imperfections with 180 degrees of phase reverse of the electron after the signal enlarged by the free electron laser amplifier.
- CeC provides path to high luminosity of future electron ion colliders
- Challenges:
 - Multialkali photocathode
 - Laser
 - High bunch charge with SC electron gun (3nC)
 - Superconducting technology
 - Helical wiggler magnets
 - Beam detection along entire beam line
 - Multi-parameter adjustment

Superconducting RF Technology



56 MHz SRF cavity for increasing RHIC luminosity



112 MHz SRF electron gun cavity for CeC



704 MHz SC cavity



5-cell 704 MHz SC Cavity



- Superconducting RF technology is adopted by all types of accelerators, light sources and colliders. It is currently the acknowledged path to high brightness, high luminosity.
- SRF development at RHIC is more towards the application and operation of the systems in the machine.
- Challenges:
 - High power and low noise RF sources
 - Low loss RF transportation
 - Stable operation
 - Low Level RF control
 - Low mechanical noise in the system

The Improvement

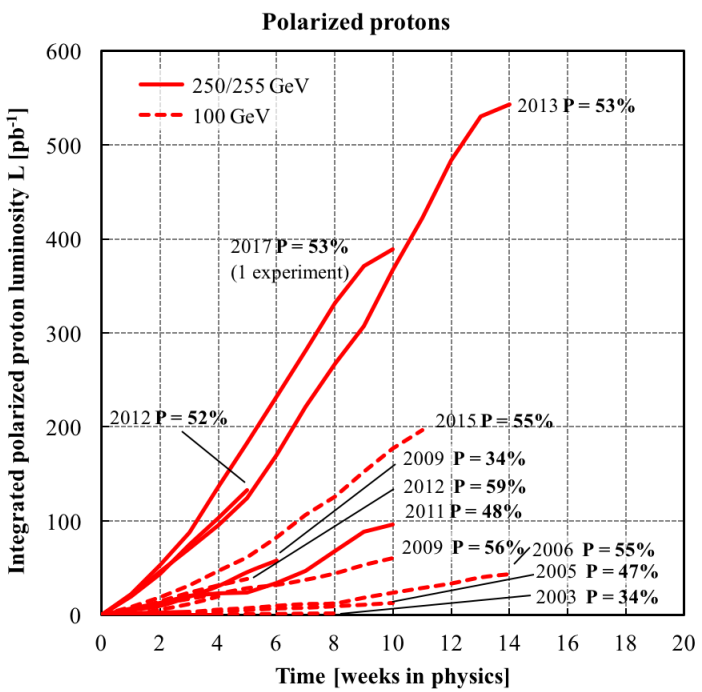

250GeV proton operation of Run17

- All the components and experiments are aiming higher luminosity
- None of the achievement today is possible without the improvement of accelerator technology

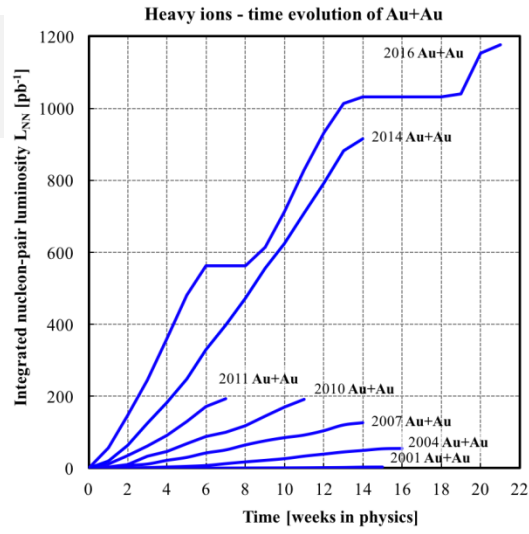

100 GeV Au operation of Run16

Various species operation over recent years

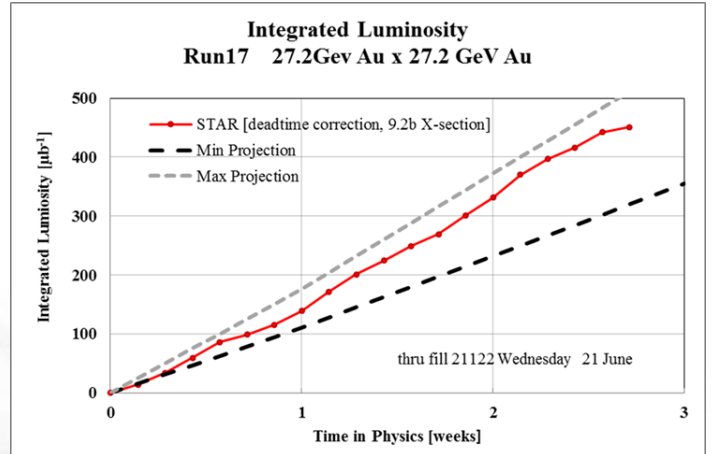
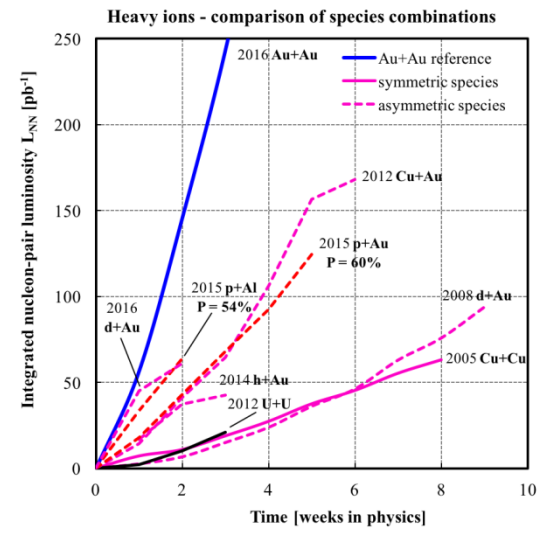

Low energy Au operation of Run17

Why outreach to industries?



Superconducting technology: Niowave (MI), AES (NY), Roark (IN), MPF Products (SC), etc..

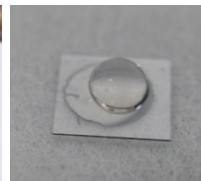

Photocathode development: MDC Corporation (CA), Transfer Engineering Inc., Atlas Technologies (WA), Tech-X Products (CO), etc.

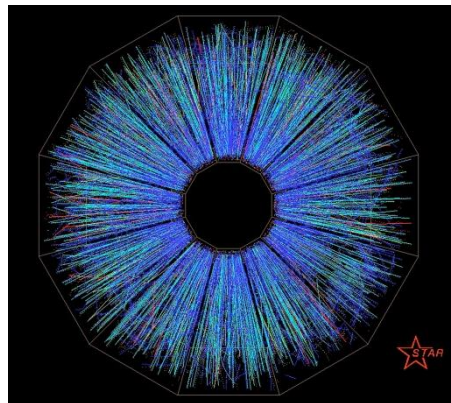
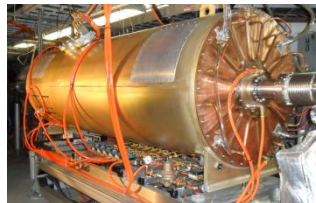

RF technology: STRECK'S (NY), Javcon Machine Inc. (NY), Mini Circuits (NY), Compac Development Corp. (NY), etc.

Cryogenic supplies: Barber-Nichols (CO), Ability Engineering Technology (IL), PHPK Technologies (OH), Cryofab (NJ), etc.

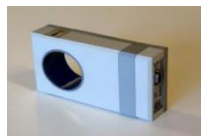
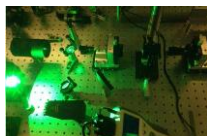

Instrumentation: Rocky Mountain Instrument Co. (CO), Beam of Light Technologies, Inc. (OR), CEM Ltd. (NY), Barth Electronics (NV), etc.

Power supply: Applied Power Systems (NY), SC Electronics (TX), KEPKO (NY), Anta Electronics (NJ), etc.

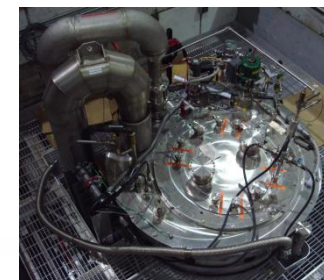

70 YEARS OF DISCOVERY
A CENTURY OF SERVICE

Looking into the future –the electron-ion collider

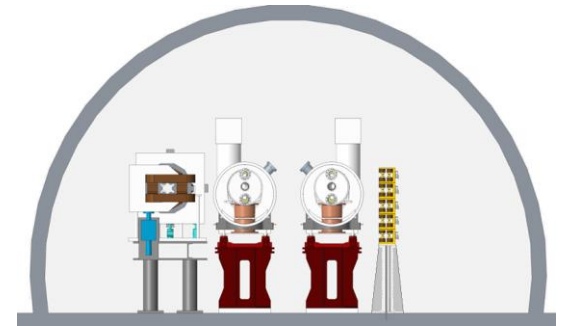
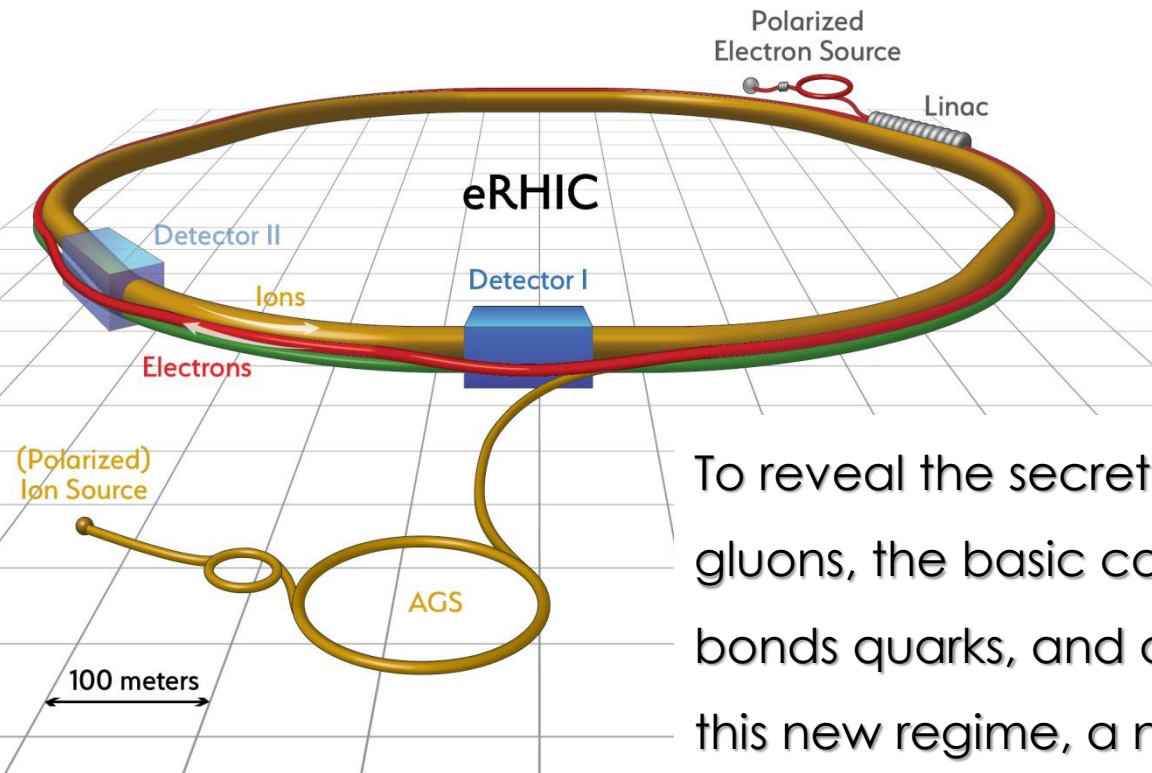

To reveal the secret of 'color' changing between gluons, the basic constituents of nucleons that bonds quarks, and quantitatively study matters in this new regime, a new experimental facility of electron ion collider (EIC) is required.

eRHIC

- Large Luminosity, scattering cross sections are small
 $L = (10^{33} - 10^{34}) s^{-1} cm^{-2}$, large average luminosity
- Large range of center of mass energy
 - electrons: (5-18) GeV
 - protons: (50-275 GeV), and corresponding
 - Ion Energies up to 100 GeV/nucleon
- Large span of ions (from light to heavy)
- Large detector forward, backward acceptance, in particular for forward scattered hadrons at small angle
- Fast, bunch-by bunch luminosity and polarization measurement to be accommodated
- The two beams must be longitudinally spin polarized in collisions 70% hadrons, 80% electrons
- All combinations of spin orientations present in one fill

eRHIC challenges – polarized e⁻ source

© E. Wang, eRHIC Design Choice Validation Review, April 2017

- Low repetition rate, high charge
 - 1 Hz for 50 nC
 - 4 bunches 1 Hz for 12.5 nC with accumulate ring
- Short bunch length
 - 15-30 ps (~1 cm) for 650 MHz Linac
- High peak current >1 kA

BNL polarized gun R&D program aiming on provide the current above, which also include development of the following technologies:

- Achieve and measure XHV
- High power laser
- Ion back bombardment
- Surface charge limit measurement
- Lifetime as the function of charge
- Beam halo reduction studies
- Cathode cooling

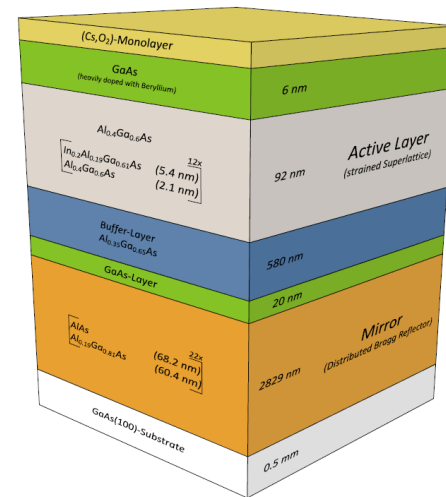

- Recent results from SVT/JLab using Distributed Bragg Reflector super lattice GaAs photocathode.
- Quantum Efficiency is greater than 5%.
- Achieved 86% polarization at the peak.

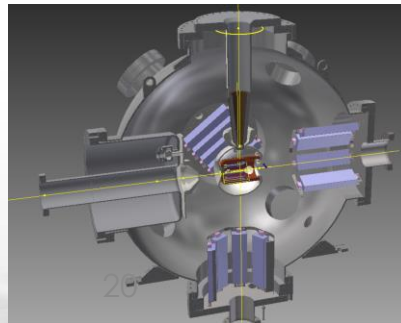

eRHIC challenges – Superconducting RF cavities (1)

eRHIC storage ring:

Medium Lumi		5 GeV	10 GeV	18 GeV
V_{sync}	MV	2.5	5.0	36.7
Average Current	A	1.3	1.28	0.27
Sync Rad Power	MW	3.25	6.4	10.0
Total Voltage	MV	12.7	28.5	62.4
# Cavities (3cell/1cell)		5/10	10/20	15/32

High Lumi		5 GeV	10 GeV	18 GeV
V_{sync}	MV	2.5	5.0	36.7
Average Current	A	2.6	2.0	0.27
Sync Rad Power	MW	6.6	10.0	10.0
Total Voltage	MV	12.7	28.5	62.4
# Cavities (3cell/1cell)		10/20	15/30	15/32

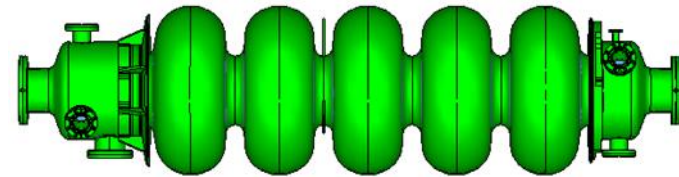

Superconducting RF (SRF) technology plays a big role in eRHIC design. Every cavity requires to deliver stable high voltage to high current electron beam.

The development of SRF systems includes:

- High quality Nb cavity fabrication
- High quality Nb cavity post processing
- Higher order mode damping
- High power fundamental power coupler
- High power RF source
- Fast Low Level RF control
- Large scale cryomodule assembly
- Precise mechanical motion
- Magnetic shielding
- And more...

eRHIC challenges – Superconducting RF cavities (2)

eRHIC crab cavities:

Parameter	Current Design	
Frequency	MHz	337.8
Cavity radius – horizontal	m	0.16
Cavity radius – vertical	m	0.20
Cavity length – along beampipe	m	0.20
# Cavities (proton/electron)		6/2

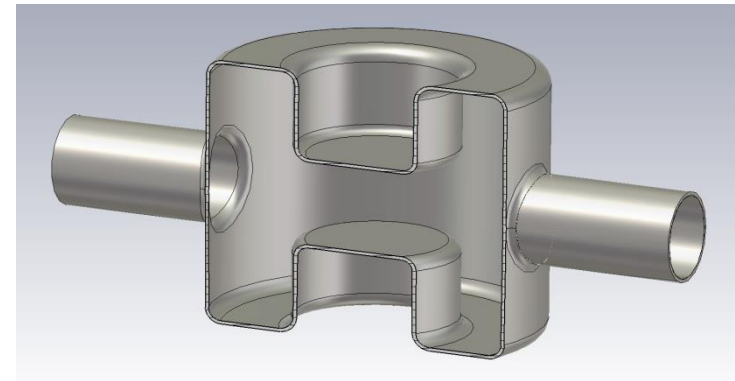

The crab cavity is essential to restore the geometric luminosity loss due to the crossing angle.

Due to the large Piwinsky angle, the geometric luminosity loss is **more than 6 times** for eRHIC.

The development of crab cavity system includes:

- All mentioned in storage ring cavities
- Fast response to cavity failure
- Alignment
- More....



3D printed Double Quarter Wave Crab Cavity at CERN (Resin with coating).

A 3D printed metal cavity would be ideal to test all major low power RF characteristics, with a very fast turnaround time...

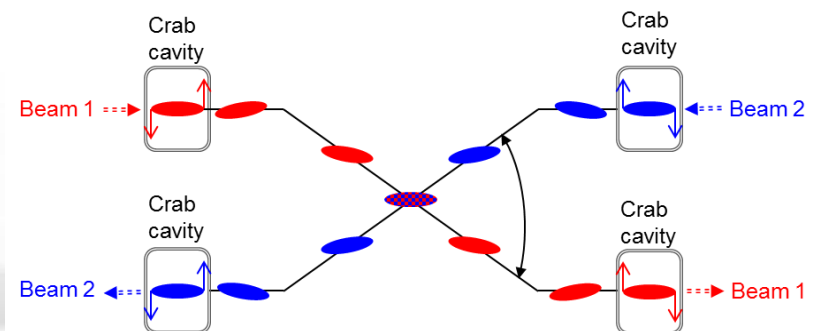

eRHIC challenges – large scale computation

- The design of eRHIC delivers particles per bunch in the order of 10^{11} . In order to predict the beam dynamics with all major physics (linear and nonlinear), designers require **extensive simulations with high performance simulation tools**.
 - Long-term beam-beam effect with crab crossing scheme, with low numerical noises to resolve dynamics of $\sim 1M$ turns
 - Electron spin track to ensure minimum spin loss during acceleration, especially for rapid cycling scheme.
 - Space charge simulation of the electron injector, up to 50nC.
 - The modeling for advanced cooling
- The new simulation tool is expected to utilize the new hardware architecture (MIC/GPU) towards **exa-scale computing**.

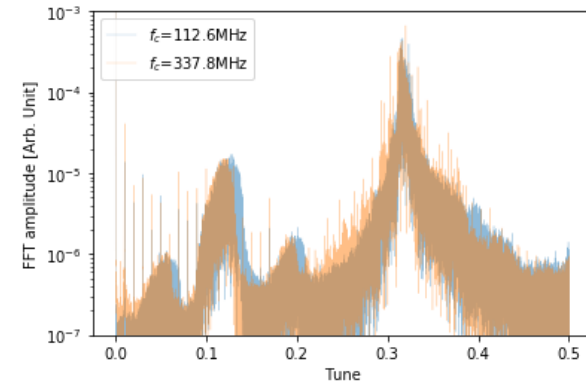
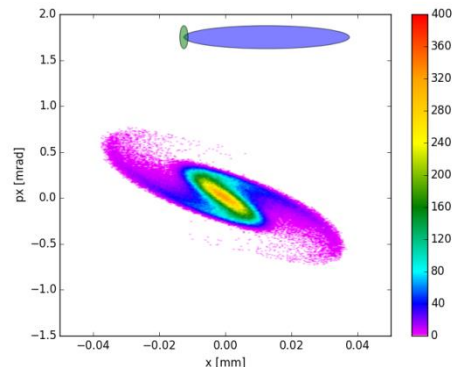

eRHIC challenges – hadron cooling

Existing cooling techniques

©V. Litvinenko, eRHIC Design Choice Validation Review, April 2017

- RF Stochastic cooling
 - It is energy independent, but limited by linear density of the cooled beam
 - For current eRHIC parameters, expected cooling time will be ~ 100 hrs
- Electron cooling
 - It is beam intensity independent, but cooling time grows as high power of beam $\tau_{\text{cool}} \sim Y^{5/2}$ or even higher
 - For current eRHIC parameters, expected cooling time for high energy (18GeV) will be a few hours

We are currently developing a new method for hadron cooling – **Coherent electron Cooling**

- Stochastic cooling with bandwidth of an electron beam amplifier: for example FEL or MBI
- Operation is energy independent – frequency scales with beam energy
- **Untested**

Electron density change with proton modulation.

J. Ma, PhD Thesis, 2017

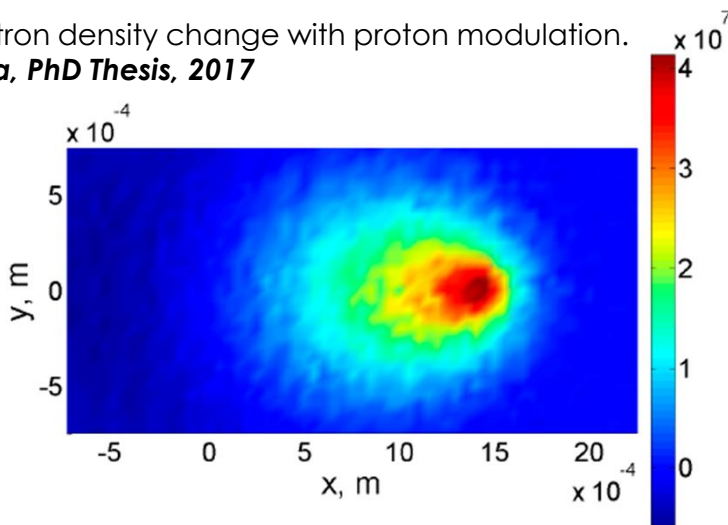

The R&D of CeC requires the development of the following topics:

- High bunch charge electron source
- Laser with long transmission path
- Superconducting RF
- Beam detection and fast diagnostic
- Simulation tools
- Machine protection
- More...

eRHIC challenges – beam pipe coating

High current beam operation will induce extra losses along the entire beam line. To reduce the loss on stainless steel beam pipes, an in-situ copper coating program has been initiated.



- Coated samples was developed at PVI System Technology Inc. (CA) under an SBIR Phase-I project.
- A cryo-resonator assembly was built at PVI (under their own cost) for the testing of the coating in liquid helium.

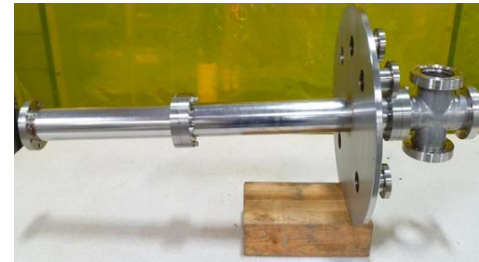

- Cryogenic testing is under preparation at BNL and should be finished before the end of September.



Challenges:

- Robust Cu coating of several microns on Stainless Steel
- In-situ coating without disassembling the beamlines in RHIC.

Summary

- RHIC provides a large and unique platform for exciting nuclear science development.
- RHIC also serves as an incubator for new technologies that can be used in multiple discipline and areas.
- eRHIC, a full upgrade of RHIC, is currently under R&D targeting performance upgrade and cost reduction.
- We have great experience in the past and in the present working with industrial partners.
- The SBIR/STTR program serves an important role in RHIC operation and R&D programs.
- We look forward to working with small business companies with novel ideas and break through innovations, in all regimes, to inspire our science and technology approach.

Thank you