



U.S. DEPARTMENT OF
ENERGY

Office of
Science

Science for Energy

Whitfield Lecture in Physics
Penn State University

April 15, 2010

Dr. William F. Brinkman
Director, Office of Science
U.S. Department of Energy

The Office of Science

- **The Office of Science (SC), within DOE focuses on basic science for discovery, innovation, and national need.**
- **Research programs span physics, chemistry, materials science, biology, climate and environmental sciences, applied mathematics, computer science, high energy physics, nuclear physics, plasma physics, fusion energy and more.**
- **The Office of Science provides state-of-the-art open-access R&D user facilities—used by more than 18,000 researchers from universities, other government agencies, and private industry each year.**
- **SC stewards 10 of the 17 DOE national laboratories.**



SC Supports Research at More than 300 Institutions Across the U.S.

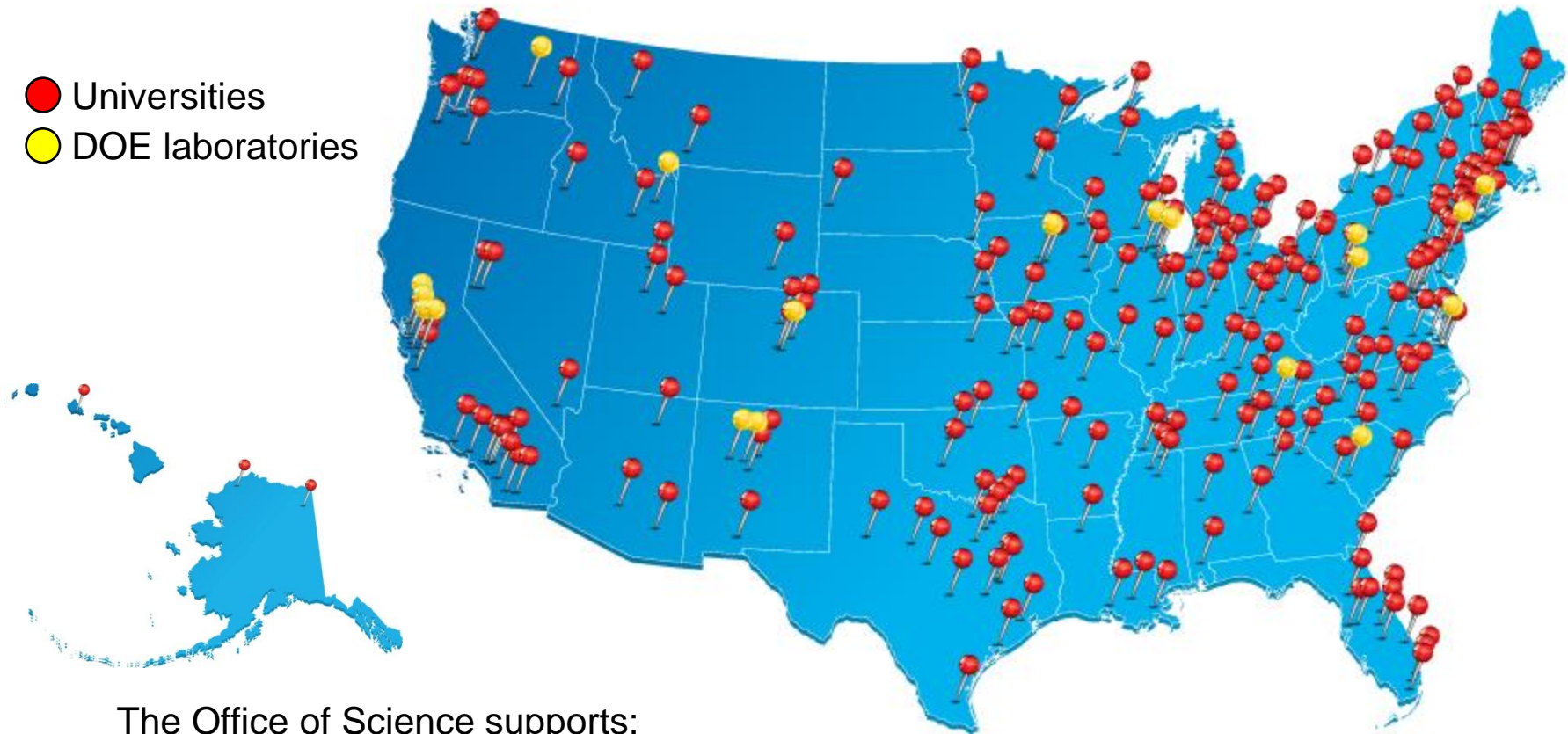

The Office of Science supports:

- **27,000** Ph.D.s, graduate students, undergraduates, engineers, and technicians
- **26,000** users of open-access user facilities
- **300** academic institutions
- **17** DOE laboratories



Connections to Penn State University



- **About \$37.7 million in FY 2009 via 69 awards**
- **About \$21 million in FY 2009 in Recovery Act money for an Energy Frontier Research Center (EFRC): Center for Lignocellulose Structure and Formation**
- **About \$3.2 million in Recovery Act funding for High Energy Physics Research**
- **The Northeastern Regional Center of the National Institute for Climatic Change Research received about \$1.7 million in FY 2009**



**New in
2010!**

Office of Science Early Career Research Program

Proposed investment in FY 2011 would bring 60 new scientists into the program

To support individual research programs of outstanding scientists early in their careers and to stimulate research careers in the disciplines supported by the Office of Science

Eligibility: Within 10 years of receiving a Ph.D., either untenured academic assistant professors on the tenure track or full-time DOE national lab employees

Award Size:

- University grants \$150,000 per year for 5 years to cover summer salary and expenses

FY 2010 Results:

- 69 awards funded via the American Recovery and Reinvestment Act
- 47 university grants and 22 DOE national laboratory awards

FY 2011 Application Process:

- Funding Opportunity Announcement issued in Spring 2010
- Awards made in the Second Quarter of 2011

http://www.science.doe.gov/SC-2/early_career.htm

**New in
2010!**

Office of Science Graduate Fellowship Program

The FY 2011 request would double the number of graduate fellowships

The Administration has requested \$10 million in FY 2011 to fund about 170 additional fellowships.

Purpose: To educate and train a skilled scientific and technical workforce in order to stay at the forefront of science and innovation and to meet our energy and environmental challenges

Eligibility:

- Candidates must be U.S. citizens and a senior undergraduate or first or second year graduate student to apply
- Candidates must be pursuing advanced degrees in areas of physics, chemistry, mathematics, biology, computational sciences, areas of climate and environmental sciences important to the Office of Science and DOE mission

Award Size:

- The three-year fellowship award, totaling \$50,500 annually, provides support towards tuition, a stipend for living expenses, and support for expenses such as travel to conferences and to DOE user facilities.

FY 2010 Results:

- ~150 awards will be made this Spring with FY 2010 and American Recovery and Reinvestment Act funds.

FY 2011 Application Process:

- Funding Opportunity Announcement issued in Fall 2010
- Awards made in March 2011

<http://www.scied.science.doe.gov/SCGF.html>



U.S. DEPARTMENT OF
ENERGY

Office of
Science

The Global Climate Crisis



U.S. DEPARTMENT OF
ENERGY

Office of
Science

Modern CO₂ Concentrations are Increasing

The current concentration is the highest in 800,000 years, as determined by ice core data

Atmospheric CO₂ at Mauna Loa Observatory

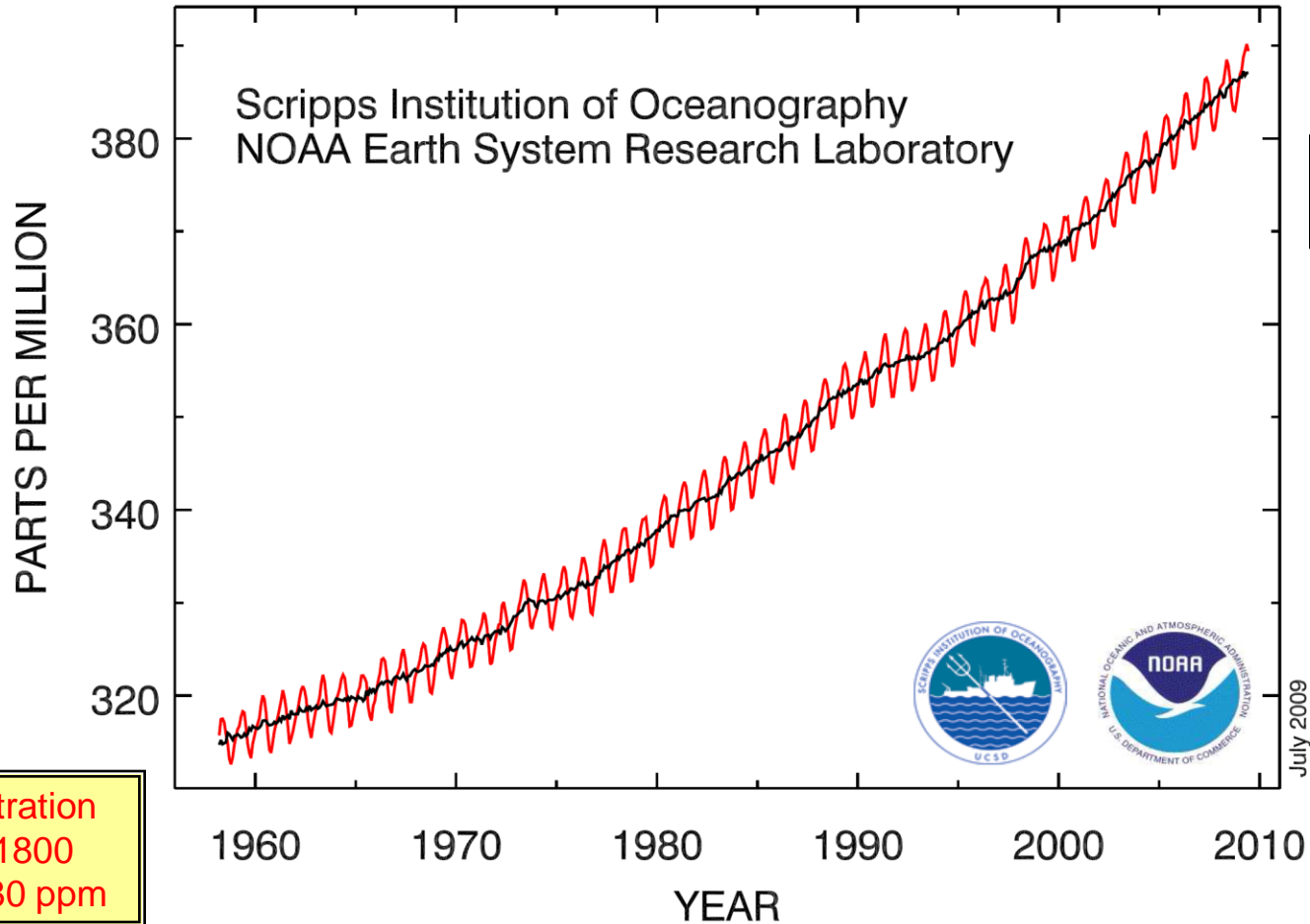

Greenland Ice Mass Loss – 2002 to 2009

Increasing rates of ice mass loss from the Greenland and Antarctic ice sheets revealed by GRACE (Gravity Recovery and Climate Experiment) satellite:

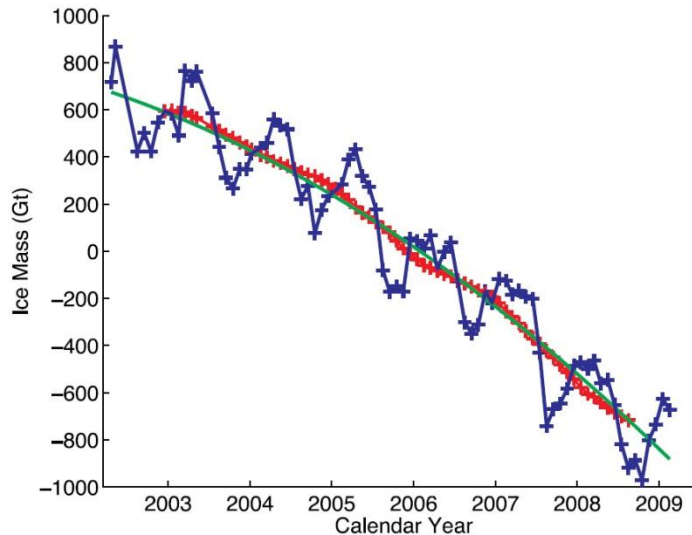

Figure 1. Time series of ice mass changes for the Greenland ice sheet estimated from GRACE monthly mass solutions for the period from April 2002 to February 2009. Unfiltered data are blue crosses. Data filtered for the seasonal dependence using a 13-month window are shown as red crosses. The best-fitting quadratic trend is shown (green line). The GRACE data have been corrected for leakage and GIA.

- In Greenland, the mass loss increased from 137 Gt/yr in 2002–2003 to 286 Gt/yr in 2007–2009
- In Antarctica, the mass loss increased from 104 Gt/yr in 2002–2006 to 246 Gt/yr in 2006–2009

I. Velicogna, *Geophysical Research Letters*, VOL. 36, L19503, 2009



U.S. DEPARTMENT OF
ENERGY

Office of
Science

Accounting for Stagnation of Global Average Temperature: The Role of Climate Model Variability

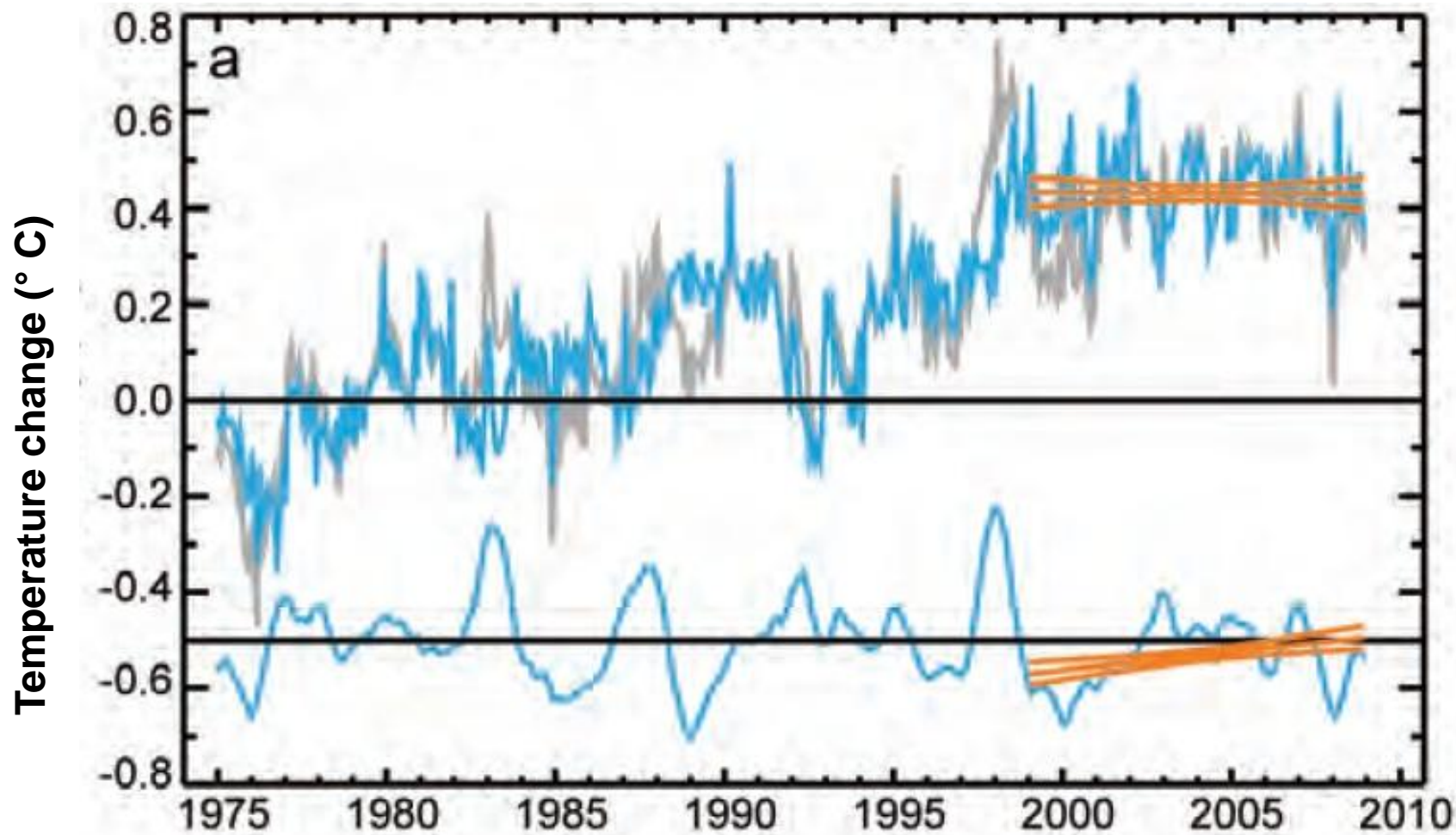

J. Knight et al., *Bull. Amer. Met. Soc.*, "State of the Climate" Supplement, August 2009



U.S. DEPARTMENT OF
ENERGY

Office of
Science

Global Surface Temperature Does Not Always Rise

Observations of Global Surface Temperature

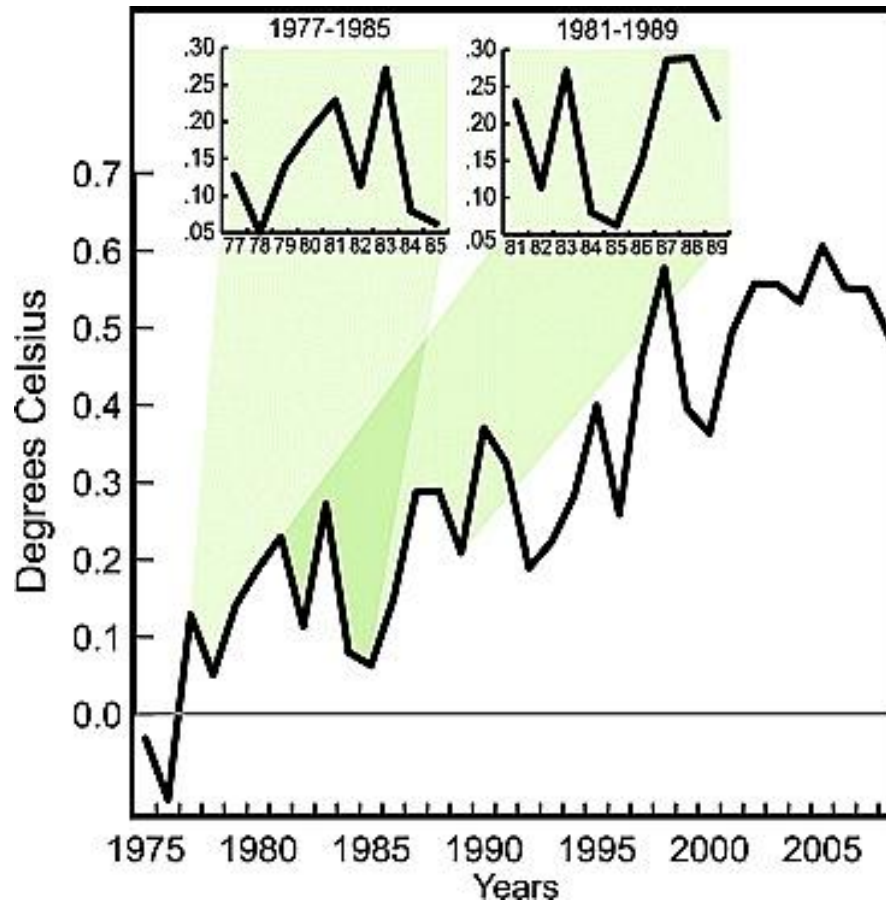

Easterling, D. R., and M. F. Wehner, *Geophys. Res. Lett.*, 36, L08706 (2009).



Models Predict Flat Periods

Model of Global Surface Temperature

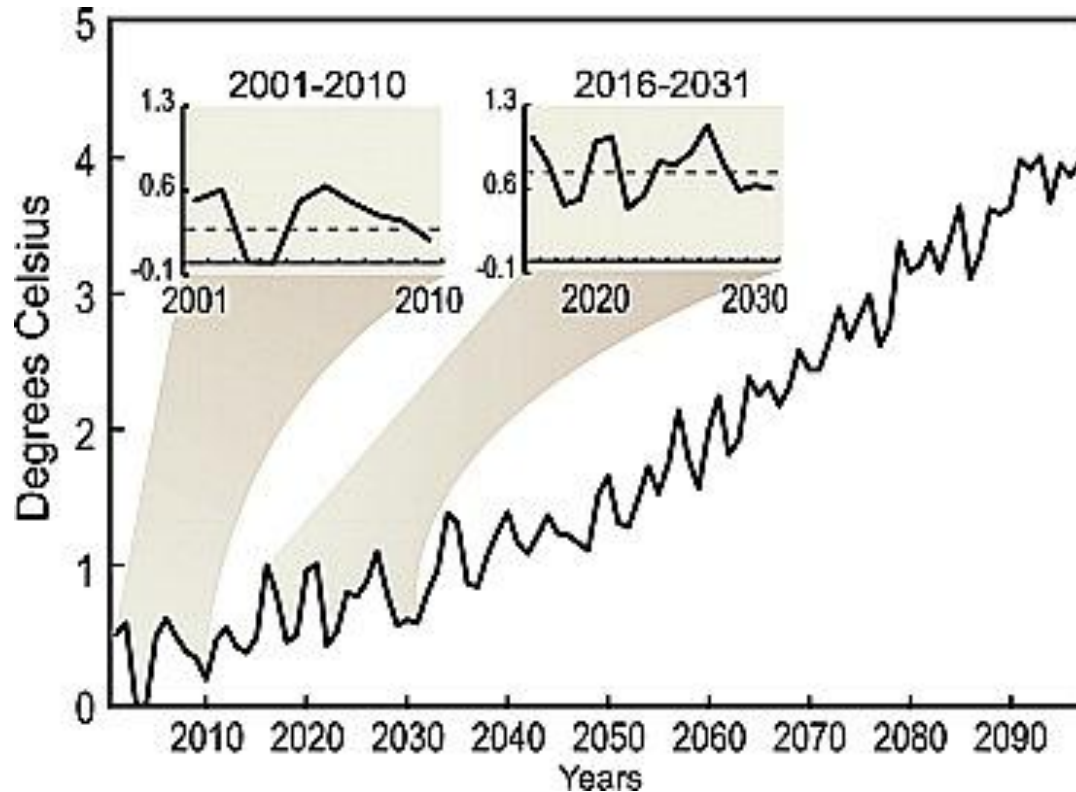

Easterling, D. R., and M. F. Wehner, *Geophys. Res. Lett.*, 36, L08706 (2009).



Global and U.S. Energy Outlook



Fossil Fuels Will Continue to Dominate World Energy Supply Under Business as Usual

IEA World Energy Outlook 2009 Reference Case

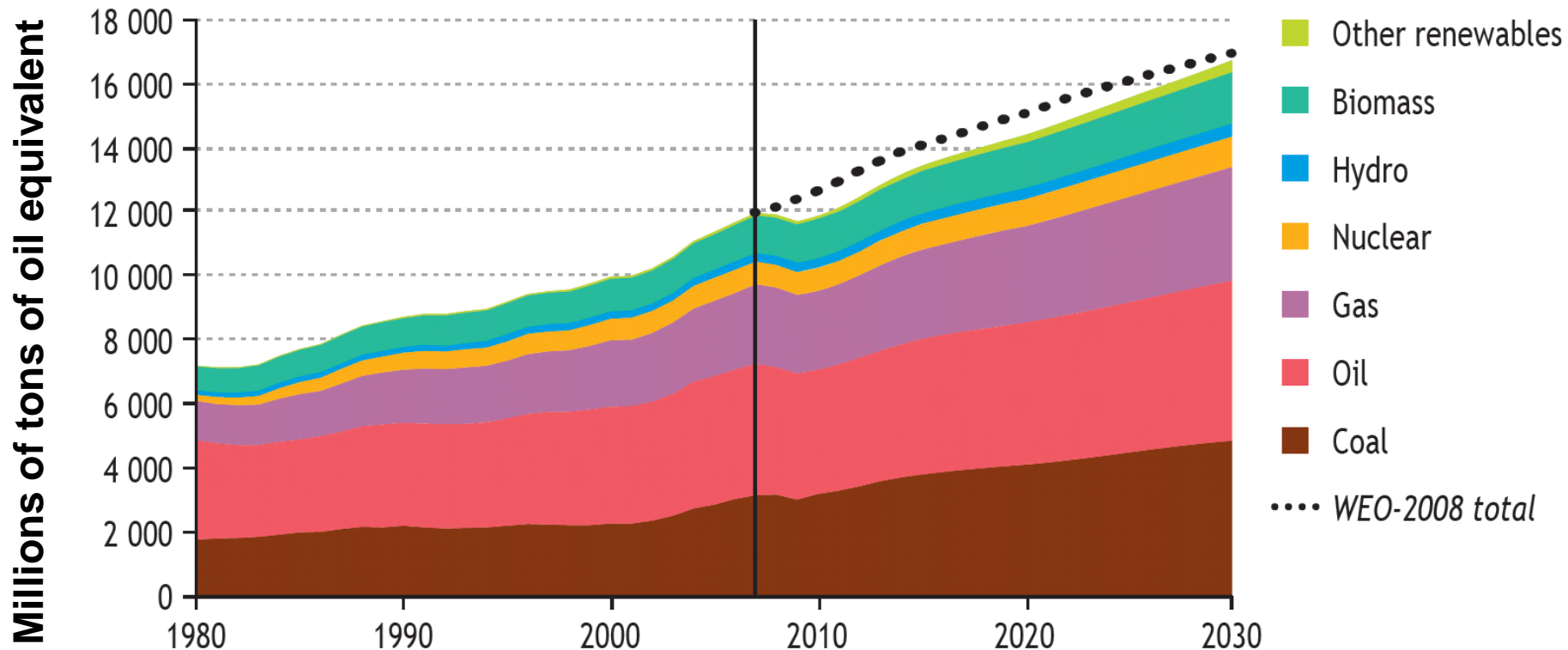

Over 90% of the increase in world primary energy demand between 2007 and 2030 is projected to come from non-OECD countries

Source: International Energy Agency World Energy Outlook, 2009.

The Market Favors Expanded Use of Unconventional Natural Gas

Today, perhaps the biggest change to the energy system is not expanded use of nuclear or renewable energy, but the development of shale gas formations through horizontal drilling and hydraulic fracturing.

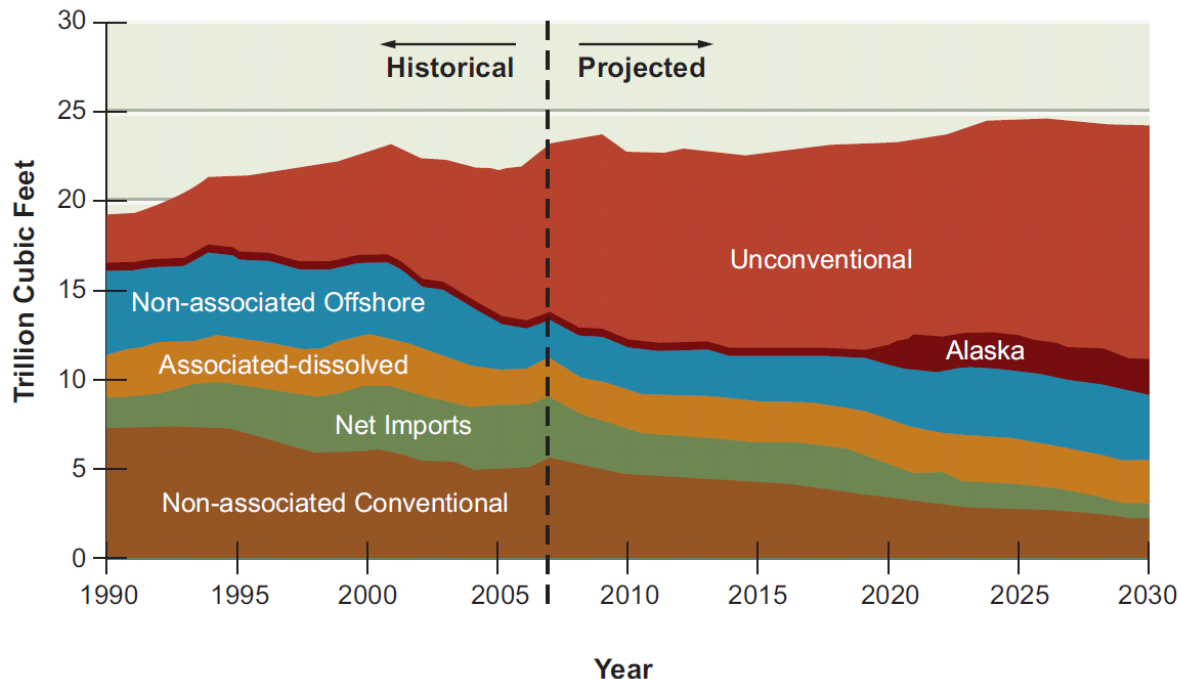

Proved natural gas reserves at the end of last year were 244.7 trillion cubic feet (tcf), the highest level since reports commenced in 1977.

Proved reserves of shale gas grew by 8.9 tcf to 32.8 tcf.

Source: Department of Energy, Energy Information Administration Annual Energy Outlook 2009, Reference Case.

U.S. Energy Production and Usage in 2008

Units in Quadrillion BTUs (Quads)

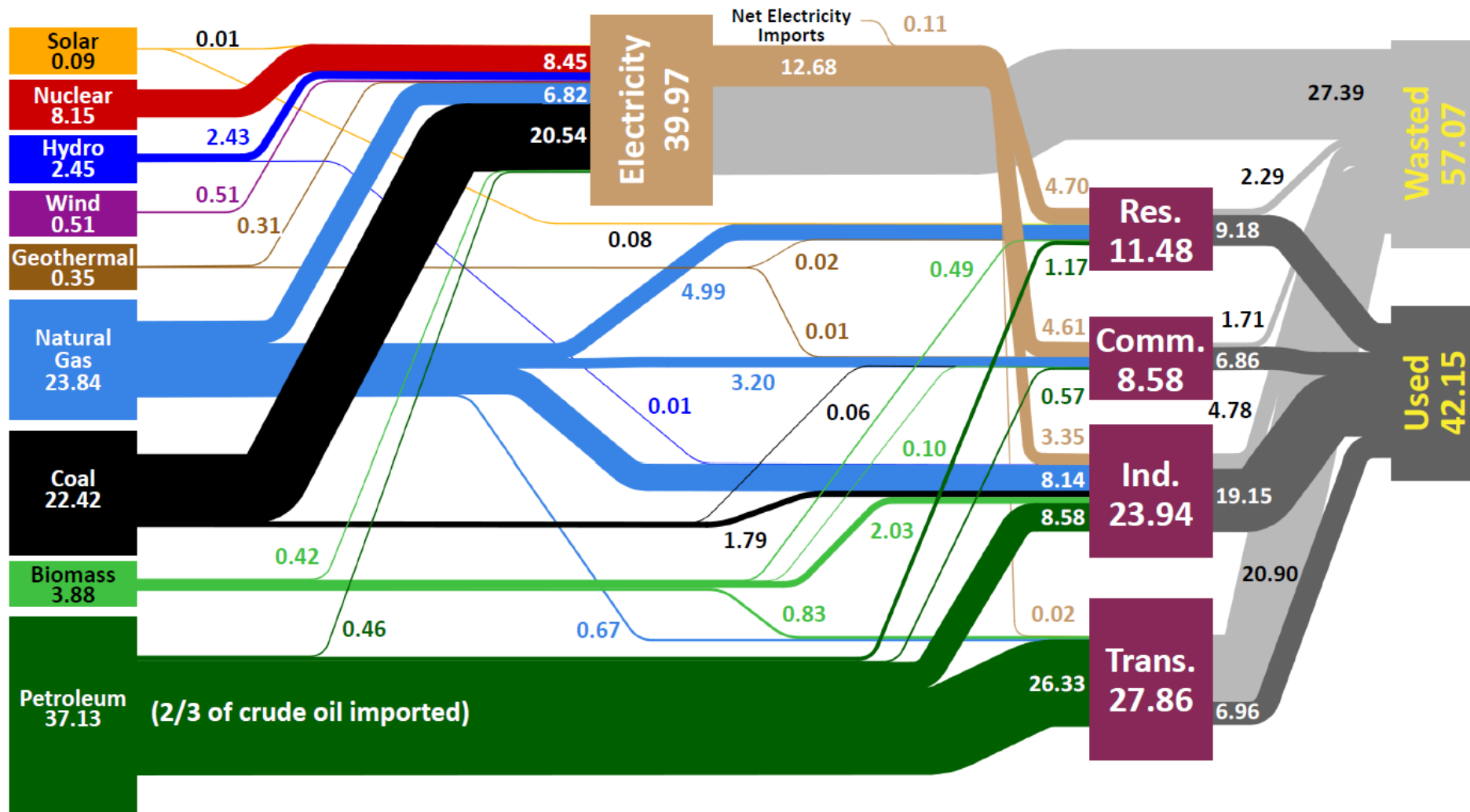

Source: Lawrence Livermore National Laboratory and the Department of Energy, Energy Information Administration, 2009 (based on data from DOE/EIA-0384(2008), June 2009).



U.S. DEPARTMENT OF
ENERGY

Office of
Science

U.S. Carbon Dioxide Emissions in 2008

Units in Millions of Metric Tons

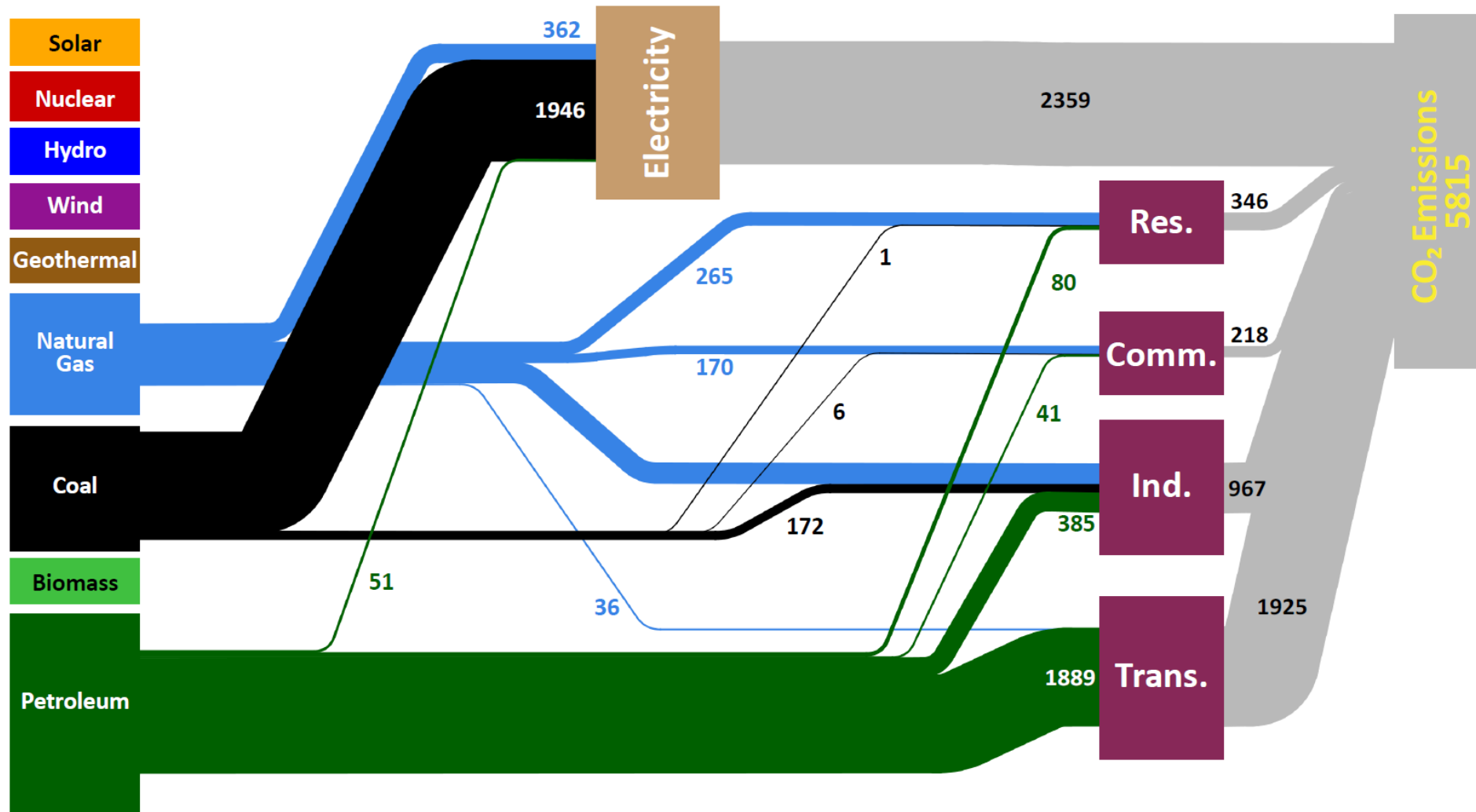

Source: Lawrence Livermore National Laboratory and the Department of Energy, Energy Information Administration, 2010 (based on data from DOE/EIA-0573(2008), December 2009).



U.S. DEPARTMENT OF
ENERGY

Office of
Science

Major Changes are Required to Reduce Greenhouse Gas Pollution

To prevent global average surface temperature from rising more than 2.5 °C by 2050 . . .

. . . we must emit **less than 1000 GT** of CO₂ between 2000–2050 . . .

. . . but our emissions rate from 2000–2010 was **33 GT per year** . . .

. . . so we must reduce our emissions **by a factor of 8** between 2010-2050.



Broad Expert Consensus on the Need for New Technologies

Scientific and technological advances will be required to make major changes to the energy system a “no brainer” for consumers and industry.

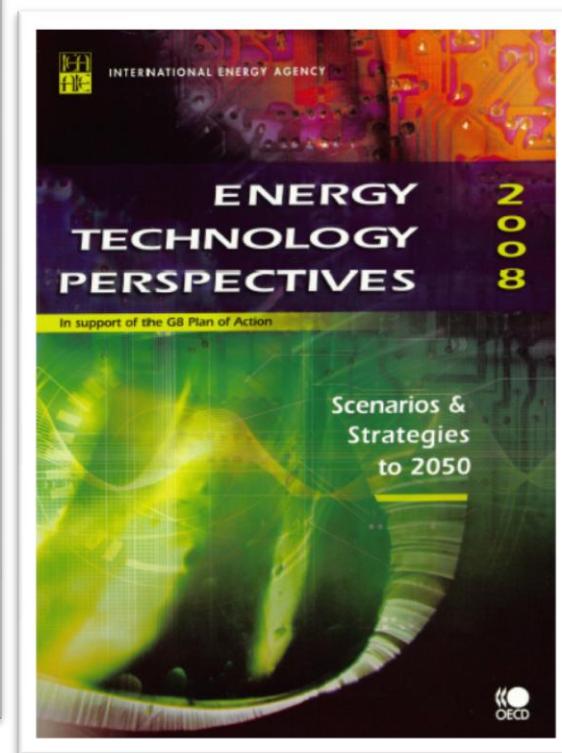
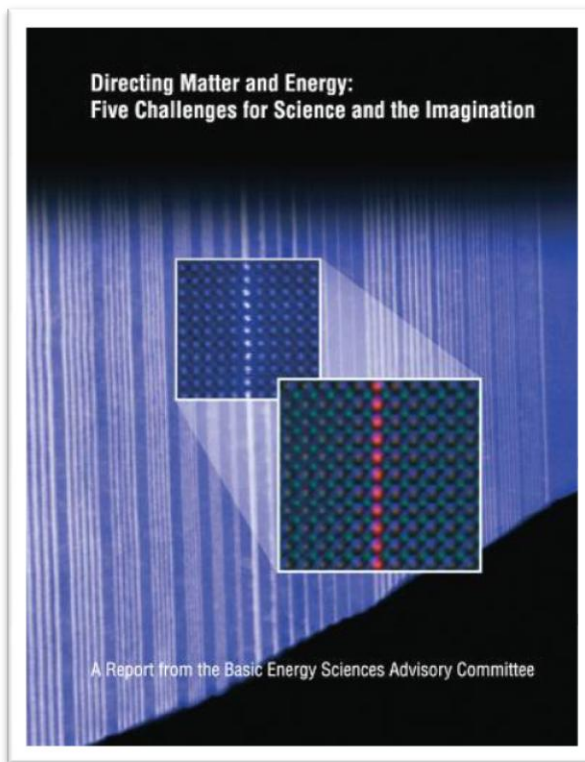
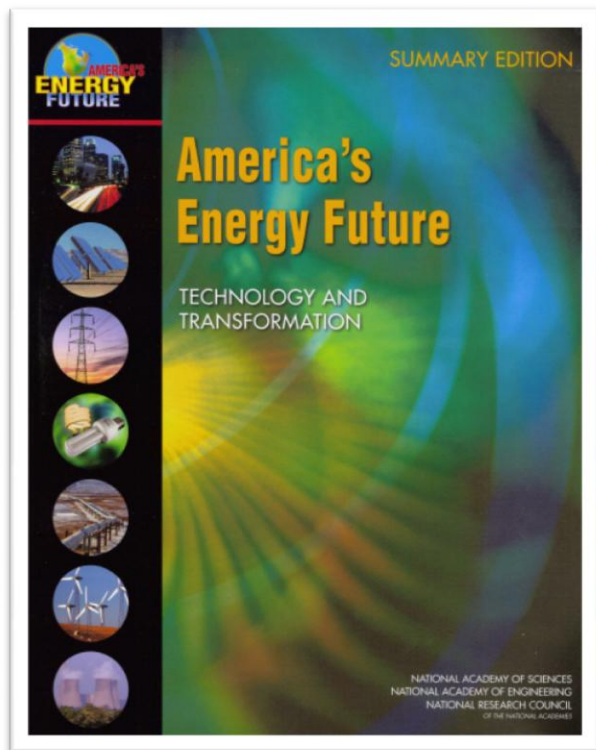

A National Strategy for a New Energy Economy

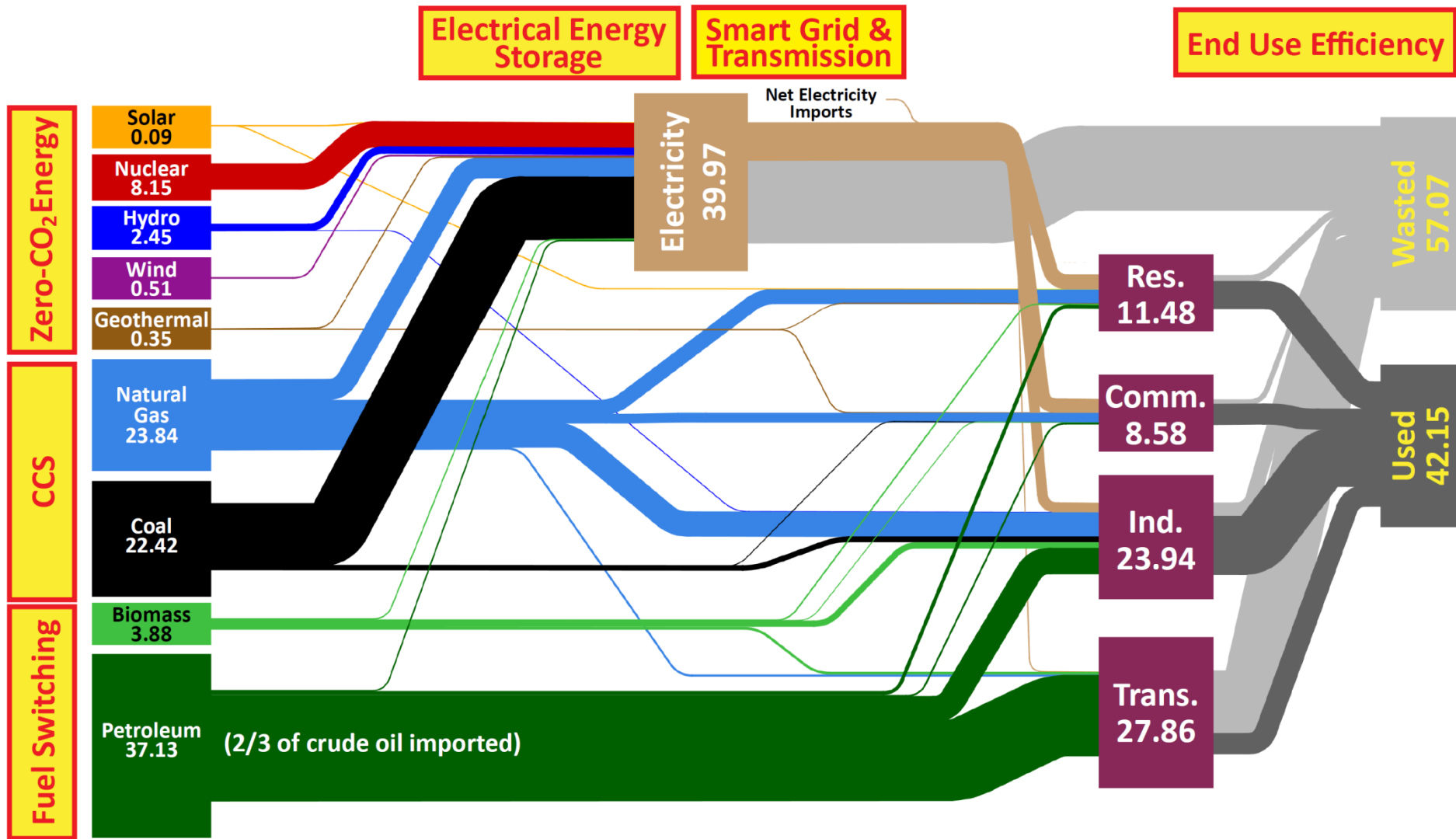

Science for Zero Carbon Energy

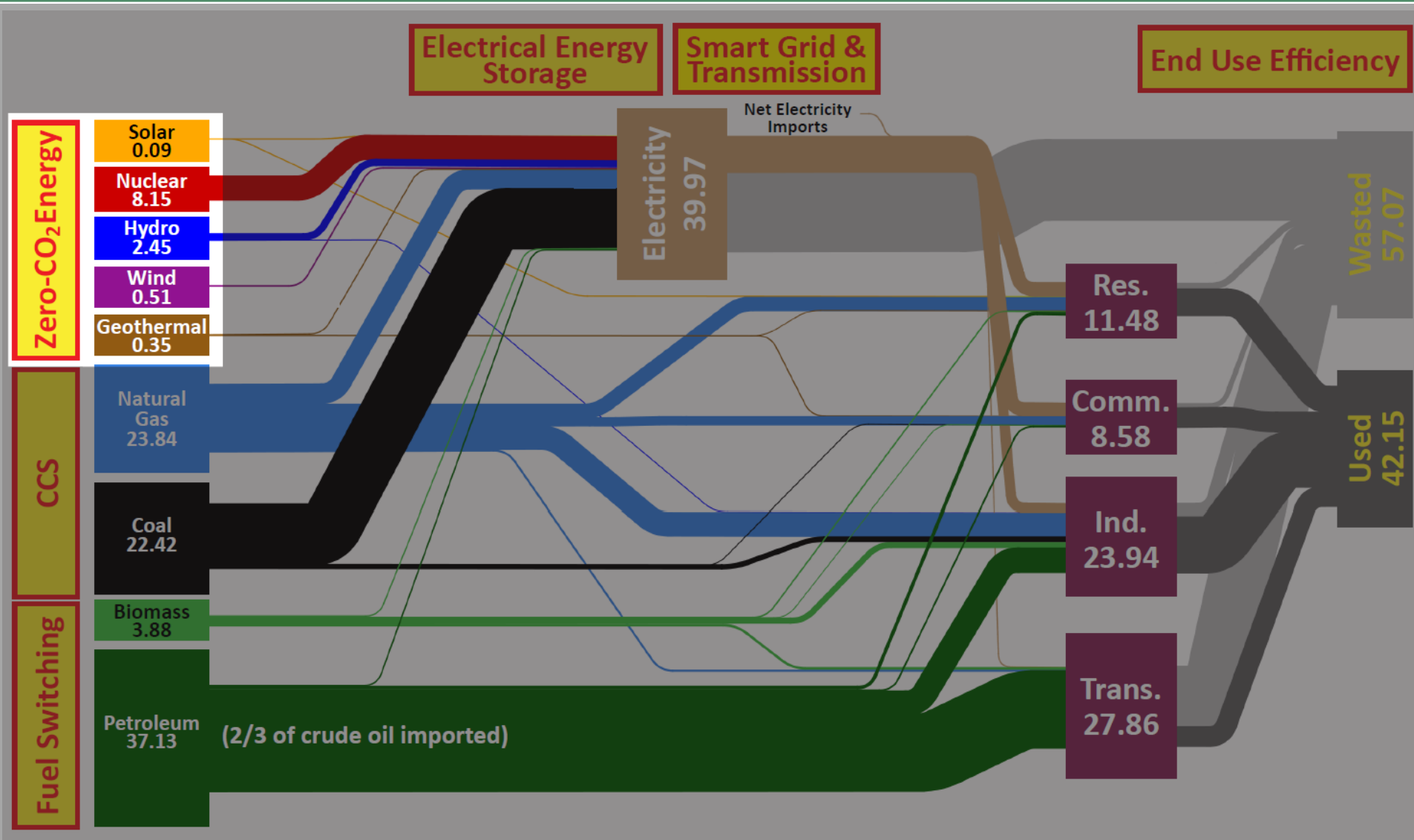

Solar Photovoltaics



Cost Competitiveness of Solar Energy is Improving

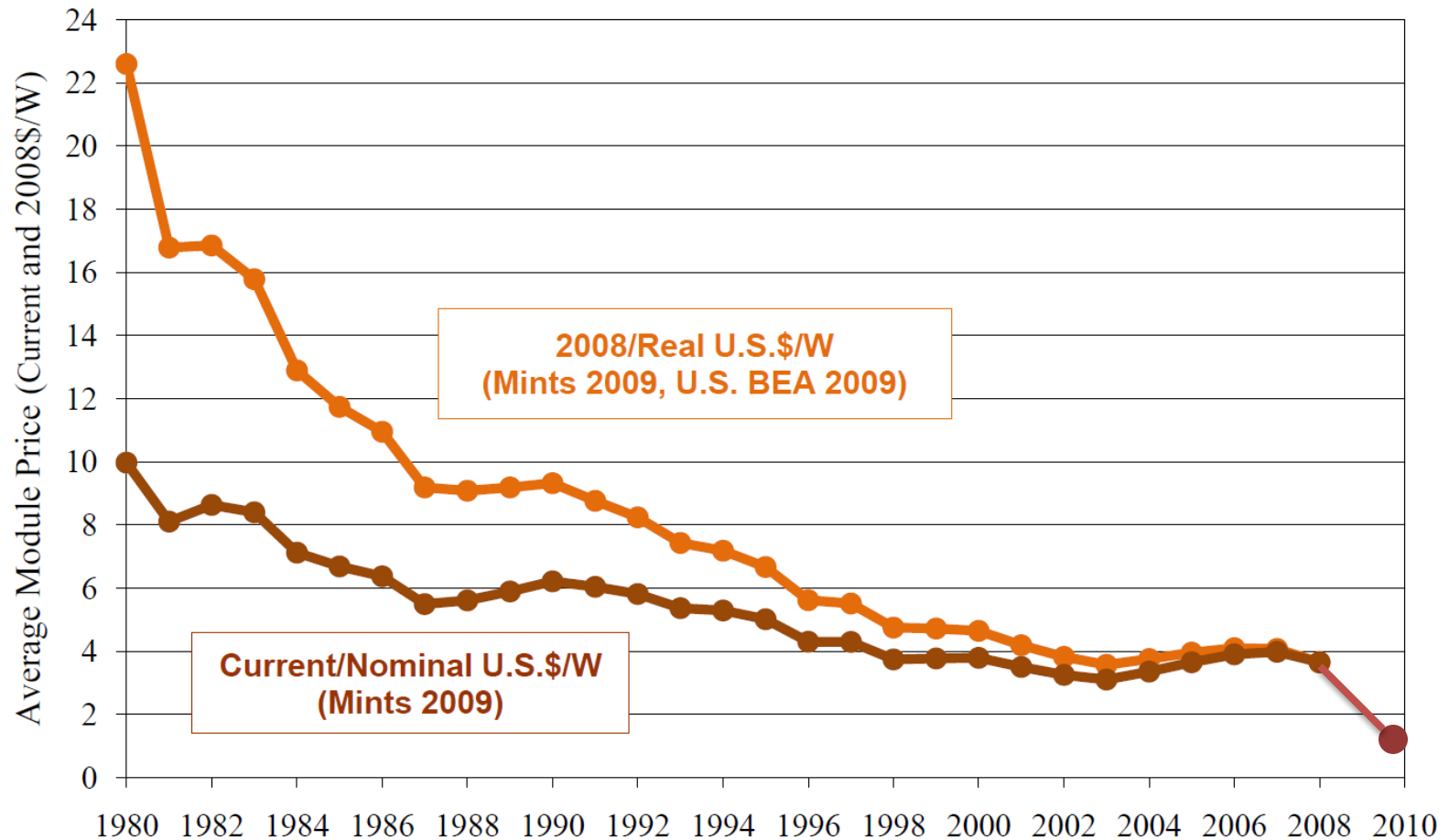

Source: Mints, P.; Tomlinson, D. (2008). *Photovoltaic Manufacturer Shipments & Competitive Analysis 2007/2008*. Report # NPS-Supply3. Palo Alto, CA: Navigant Consulting Photovoltaic Service Program and Mints, P. (2009). *Photovoltaic Manufacturer Shipments, Capacity, & Competitive Analysis 2008/2009*. Report # NPS-Supply4. Palo Alto, CA: Navigant Consulting Photovoltaic Service Program.



Solar Photovoltaics: We Can Still Do Better

- **Technology Challenge:** Reduce costs and increase capacity for converting sunlight into electricity
- **Silicon:** Top commercial solar cells (single crystal silicon) have conversion efficiencies of ~18%; triple-junction cells with Fresnel lens concentrator technology are ~40%.
- **Science Challenges:** Cost-effective improvements in efficiency depend on understanding and controlling phenomena at the nanoscale.

New Techniques for Improvement of PV Cell Efficiency

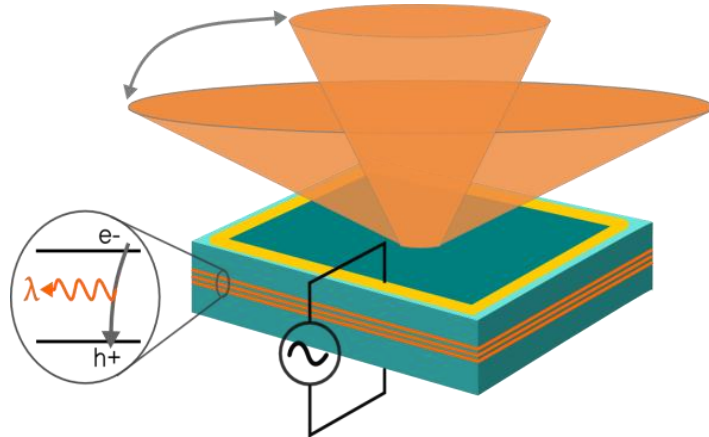

Molding the flow of light: a novel photonic design for antireflection coatings for multiple wavelengths and light incident angles

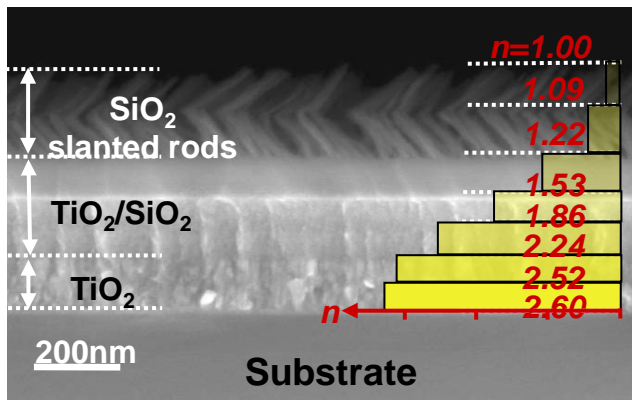

SEM Image of a 7-layer graded anti-reflection coating structure

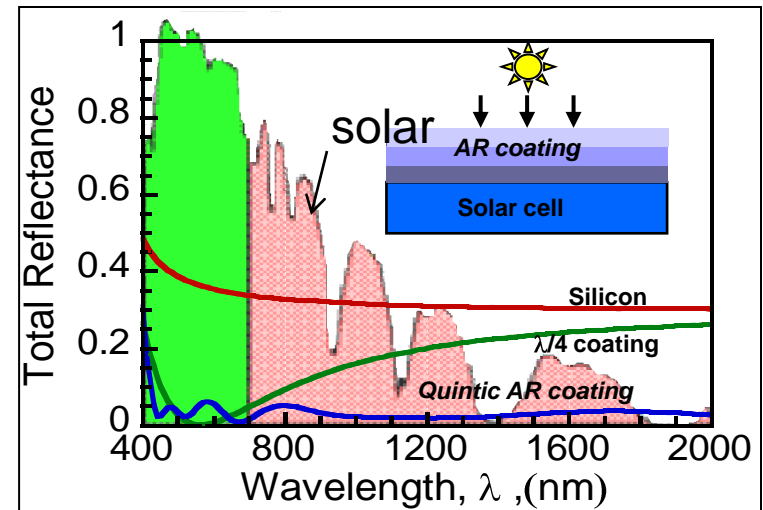

Basic science breakthrough:

- A new architectural design for antireflection coating that solves, for the first time, both the multiple wavelength and incident light angles critical for efficient solar collection.
- The multi-layer nanostructure can produce a >20% solar efficiency enhancement and is universally applicable to many type of solar cells, including Si, III-V and organic cells.

Kuo and Lin et. al. *Optics Letters*, Nov. 2008



Ultra High-Efficiency Solar Cells

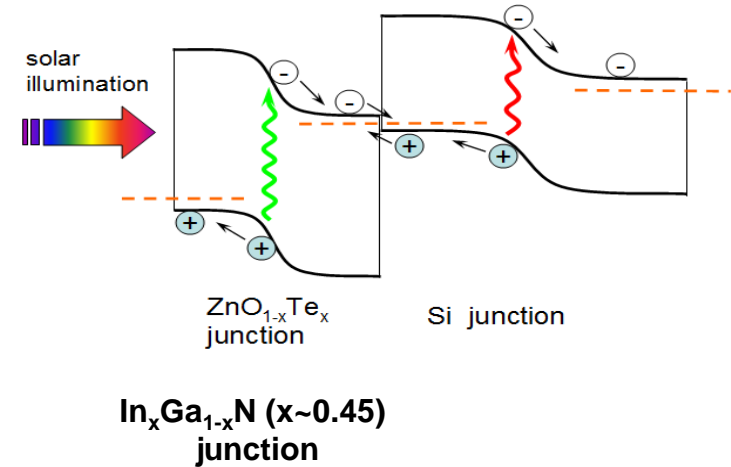
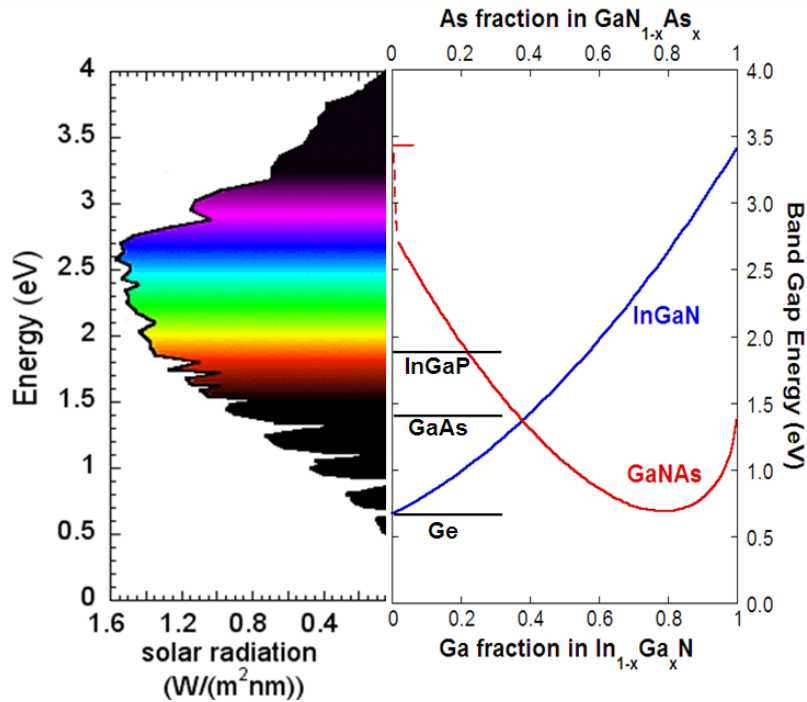

Basic science breakthrough:

- Discovery of single alloy systems with wide band gap range: InGaN and GaNAs
- Low cost alternatives to conventional multi-junction cells

Ager et al., *Phys. Status Solidi C* **6**, S413 (2009). W. Walukiewicz et al., LBNL. Yu et al., *J. Appl. Phys.* **106**, 103709 (2009).



Advanced Fission & Fusion Energy Systems



Materials Science for Advanced Fission & Fusion Energy

Advanced fission and fusion reactors will operate at much higher temperatures than typical operating ranges of most materials today.

High temperatures are known to degrade strength over long time periods, especially when combined with other extreme conditions.

Gas-cooled nuclear reactor

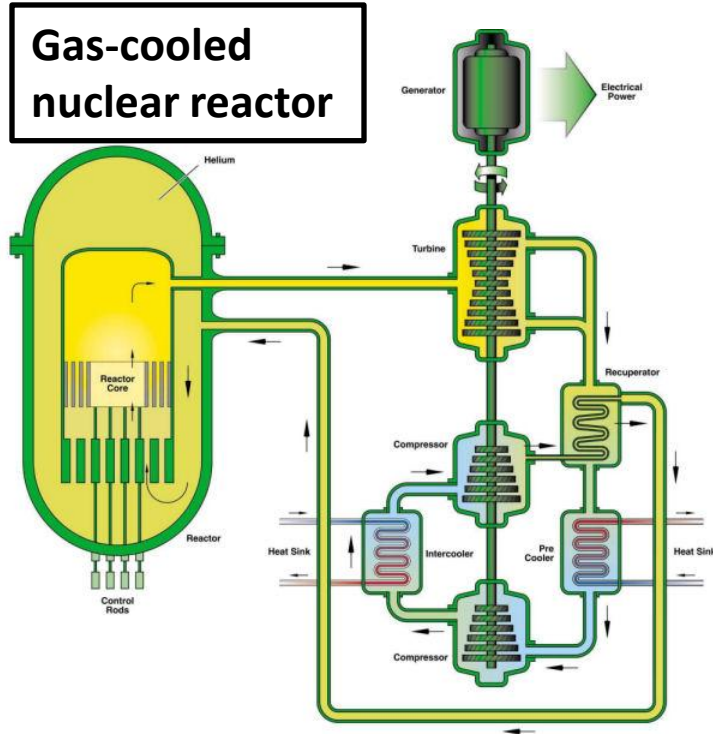

Tokamak fusion reactor

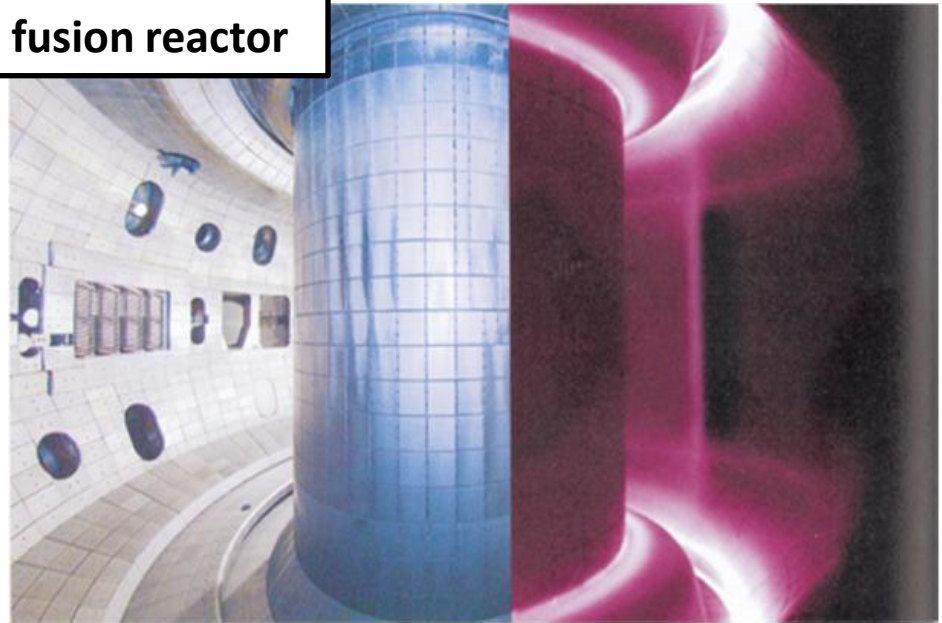

Damage in Metals Due to Neutron Exposure

The neutrons emanating from fission and fusion reactions induce damage by disrupting the locations of atoms in the nearby materials.

Voids formed from clustering of vacancies lead to swelling in irradiated metals

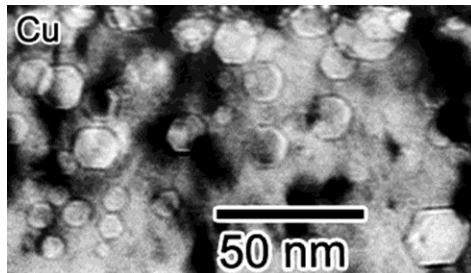

Materials have to be able to withstand fluences of 100 atomic displacements

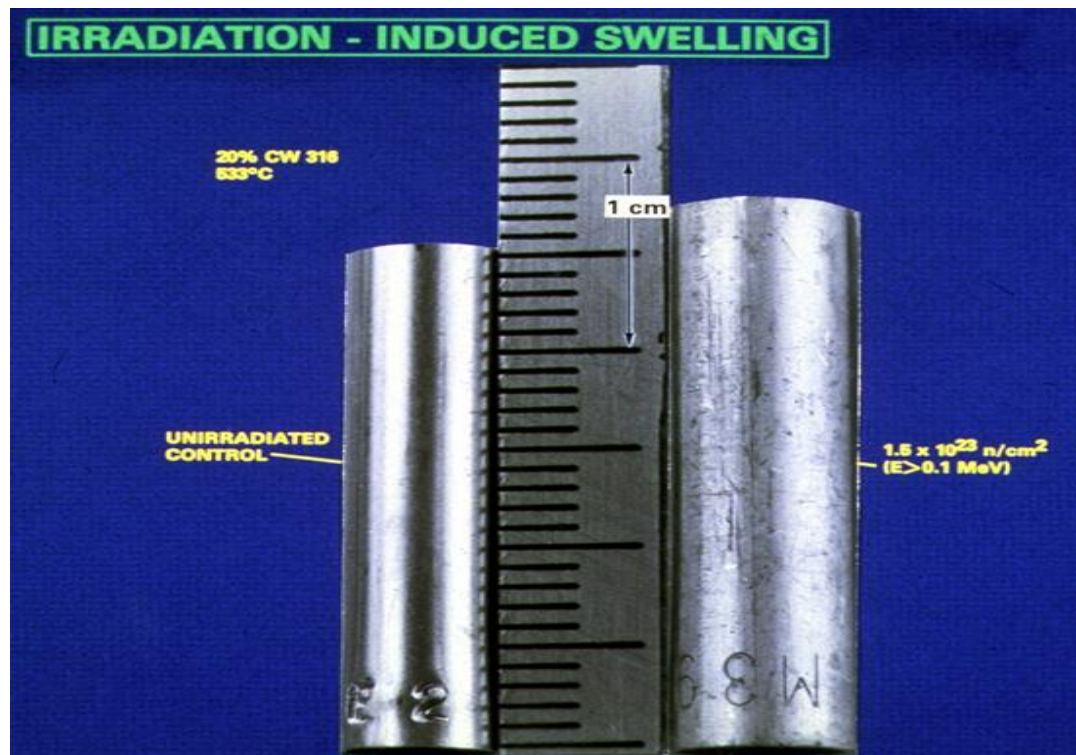

New Radiation Resistant Materials

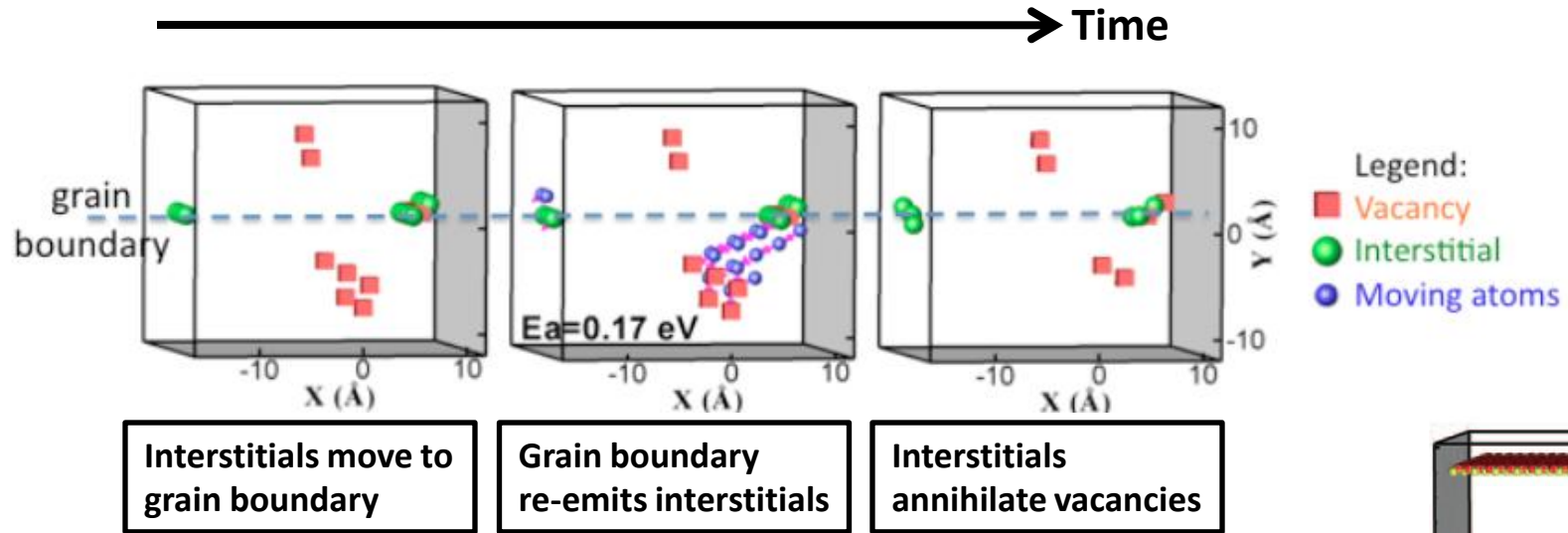

- A collision cascade displaces atoms, creating vacancies and interstitials (right, showing displaced atoms 0.5 ps after the cascade initiation).
- Fast-moving interstitials move quickly to a nearby boundary (above left). Slower-moving vacancies remain.
- A grain boundary loaded with interstitials emits them (above center)
- Nearby vacancies are annihilated (above right)
- This new mechanism may explain the enhanced radiation resistance observed in nanocrystalline materials with large numbers of grain boundaries.

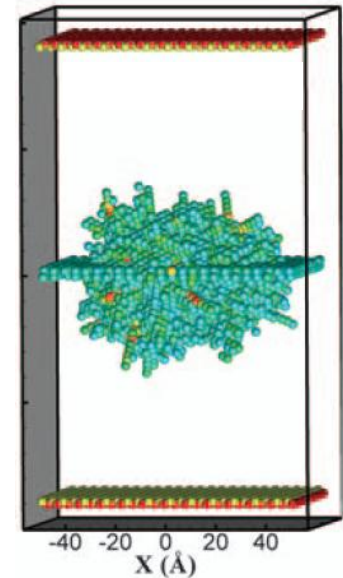

Magnetic Fusion Energy: Controlling the Burning Plasma State

- **ITER will enable “burning plasmas”**

ITER, an international project being built in Cadarache, France, will create the world’s first sustained burning plasma fusion experiment.

- **Science challenge:**

Develop a robust and predictable approach to controlling the dynamics of this plasma state.

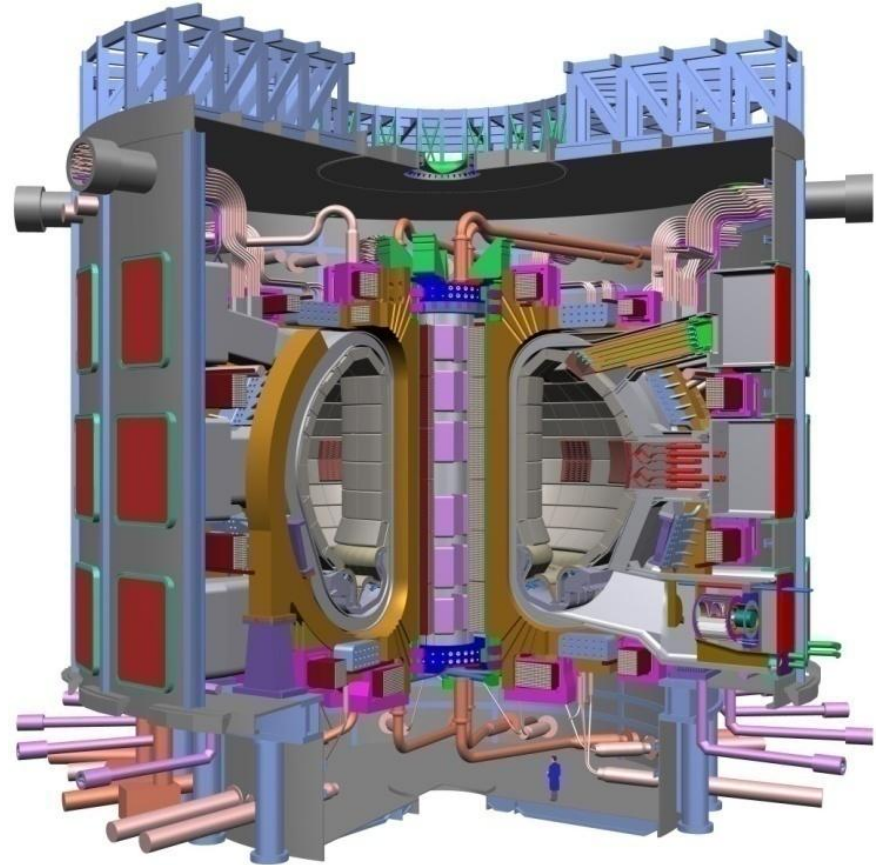

Inertial Fusion Energy: Nearing Ignition

- The newly completed National Ignition Facility – the world’s most powerful laser system – recently began full operations
- NIF is on track to achieve the first laboratory demonstration of “ignition” or net energy gain

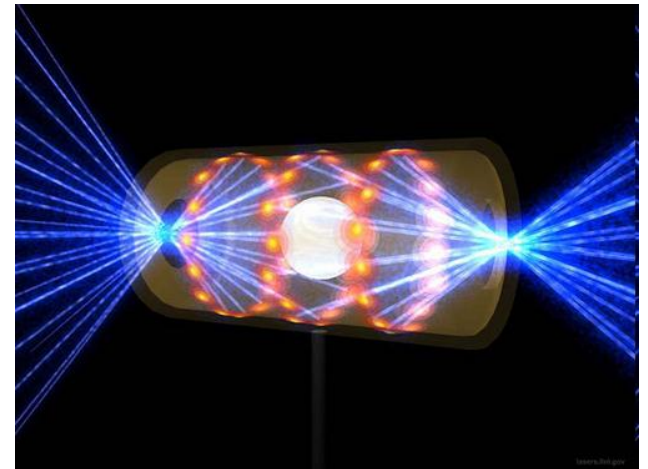
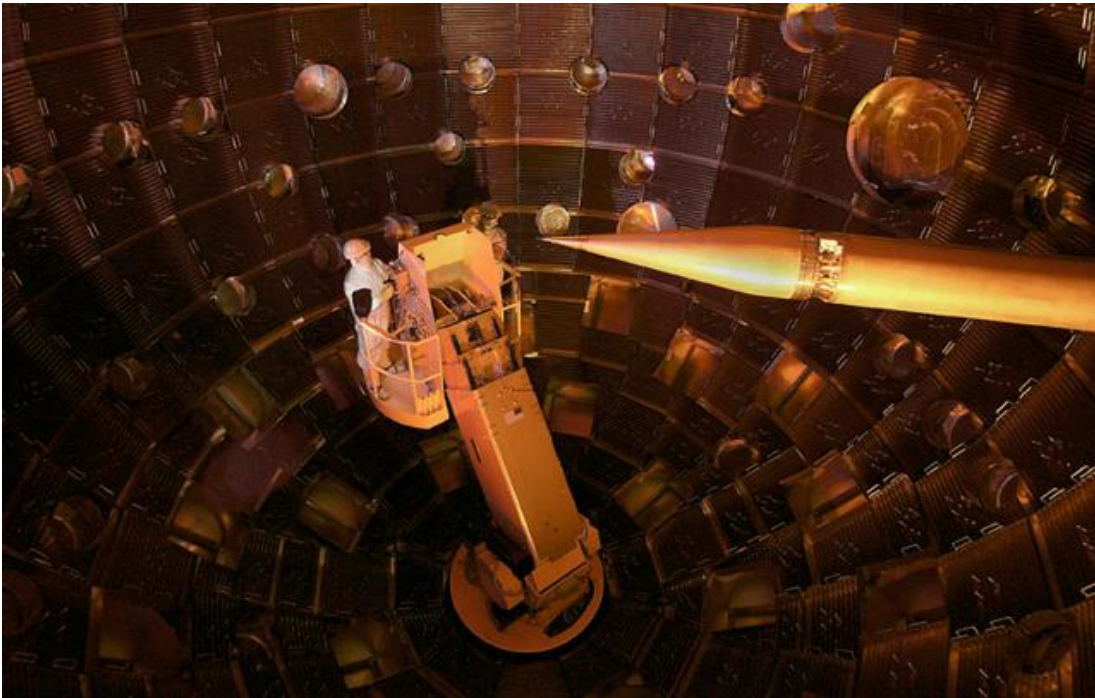

Science for Carbon Capture and Sequestration

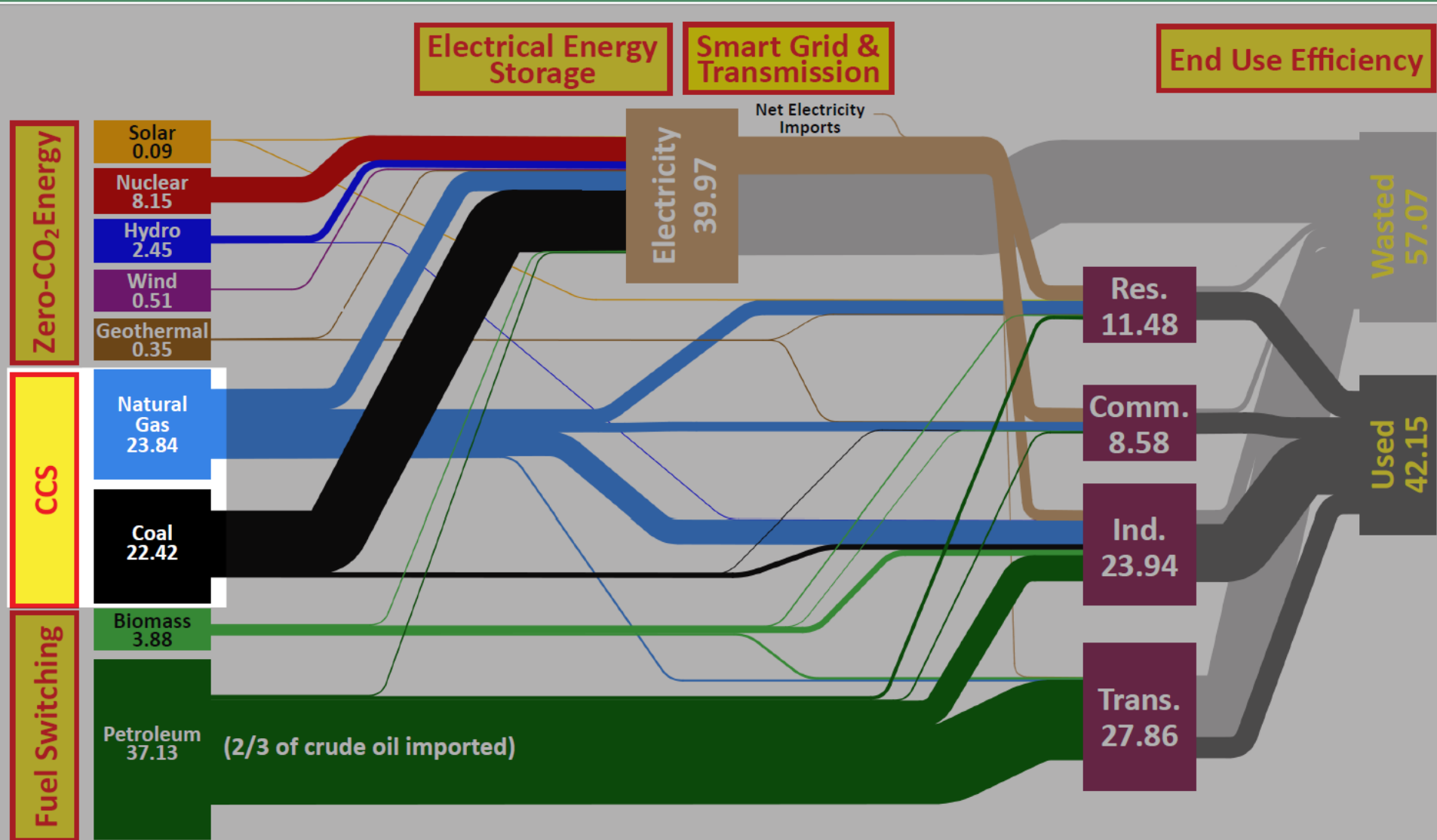

Carbon Capture and Sequestration

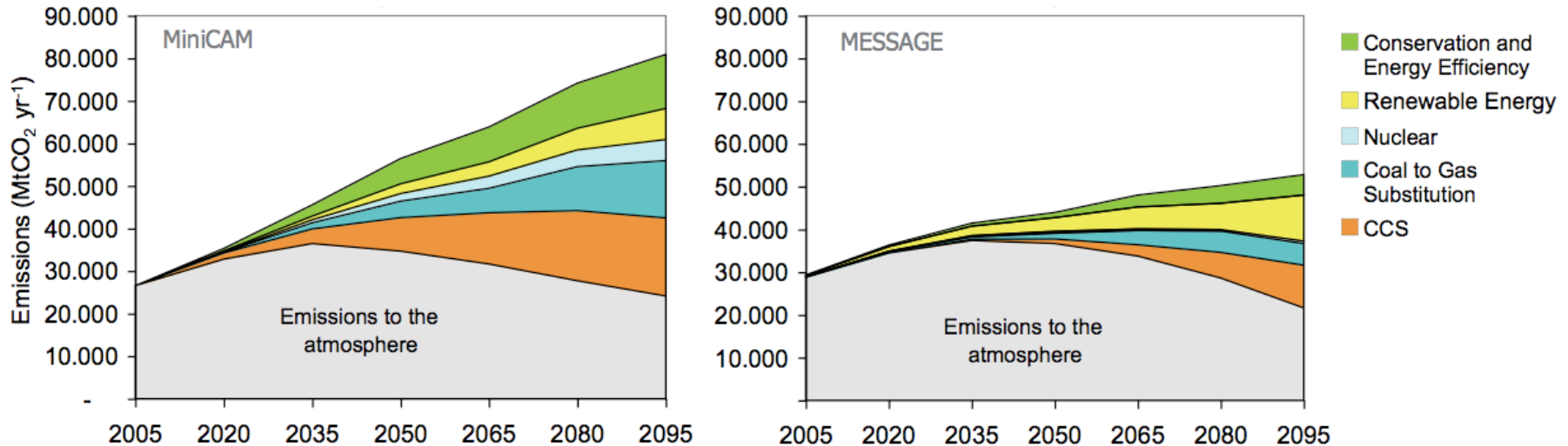

- Continued use of fossil fuel while capping the atmospheric concentration of carbon dioxide to about double the pre-industrial level requires the sequestration of ~10 GT of CO₂ per year.
- Current technologies for the post-combustion capture of CO₂ are too expensive.
- “Underground” as a long-term storage container
 - Advantages: Enormous volume; distance from subsurface environment; pre-made container
 - Disadvantages: Designed by nature, only approximately fits the design criteria for containment; complex materials and processes; difficult to see and monitor; uncertainty about long-term performance



Today's Carbon Capture Options

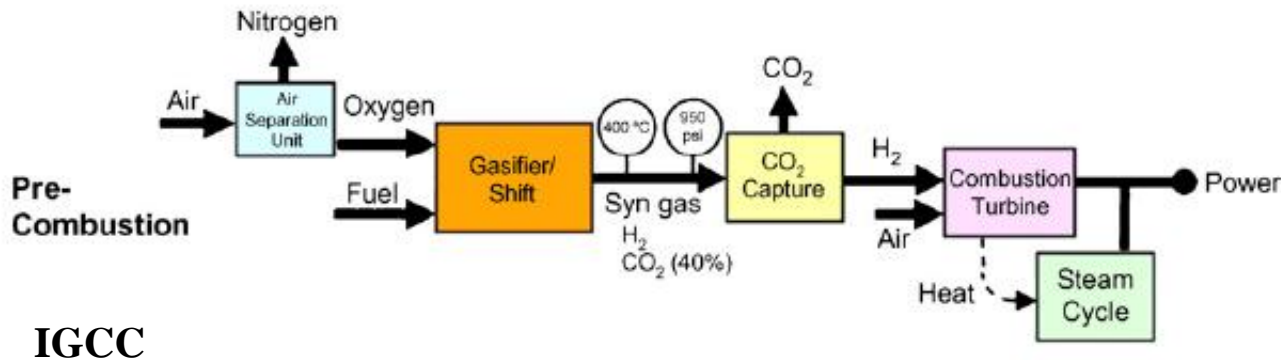
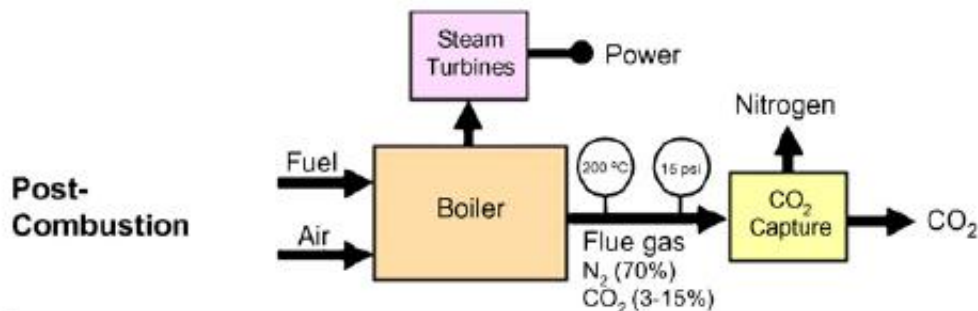

IGCC

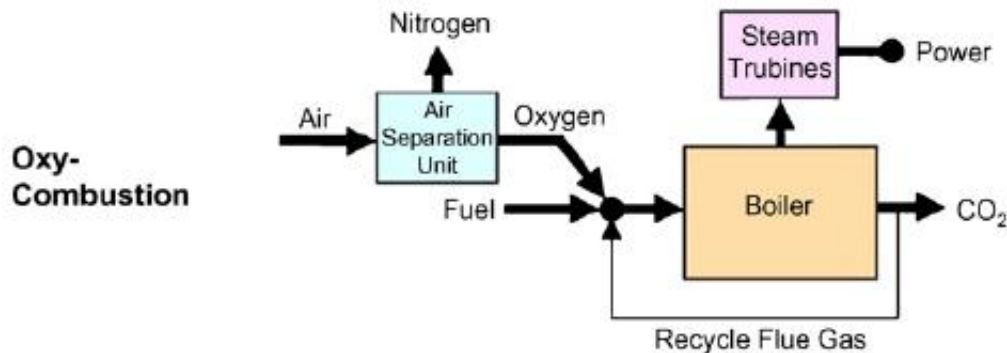

Challenges

- Low CO₂ Concentration
- High energy for regeneration
- Mostly new plants
- Oxygen production – Air Separation Units (ASUs) have high electricity cost (chemical looping, ITMs)
- ASUs consume considerable energy
- Expense - corrosion resistant materials



New Materials May Aid in Capturing Carbon Dioxide

Metal-organic frameworks (MOFs) act as “crystalline sponges” and show promise at reducing the energy penalty for CO₂ capture.

A new magnesium-based MOF is selective in capturing CO₂ in the presence of CH₄ and releases the stored CO₂ at temperatures much lower than current capture media.

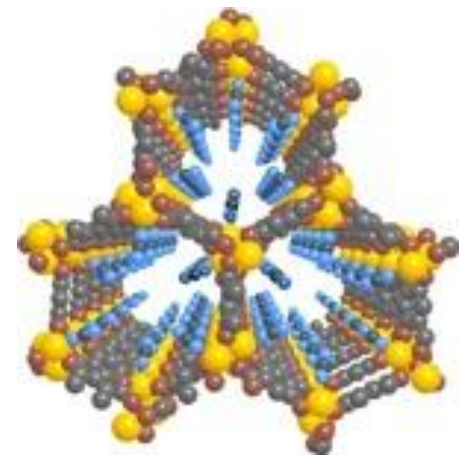
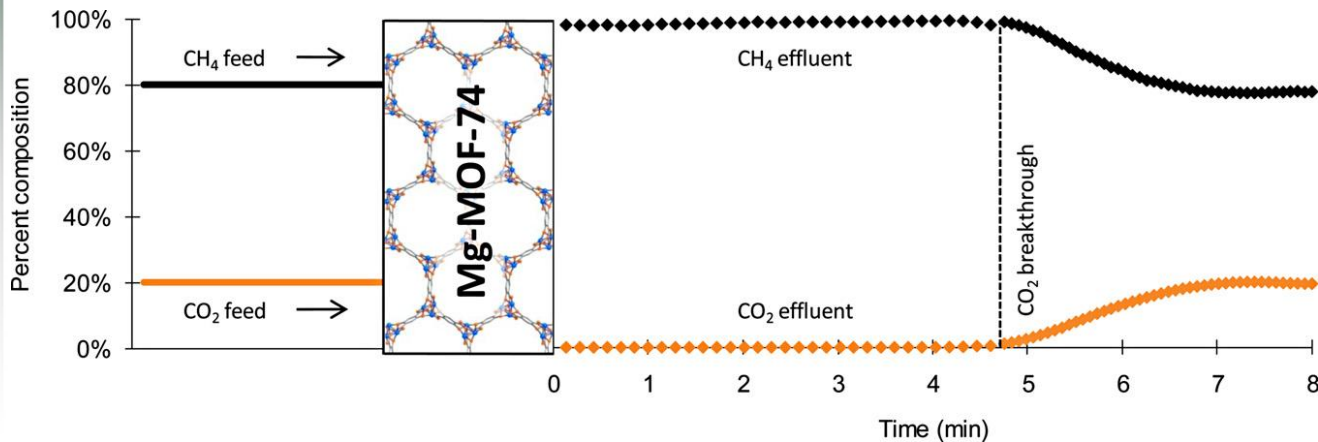

Schematic structure of Mg-MOF-74

D. Britt, H. Furukawa, B. Wang, and O. M. Yaghi, PNAS 106, 20637 (2009); also see N.Y. Times on Dec. 8, 2009.



Geological CO₂ Sequestration

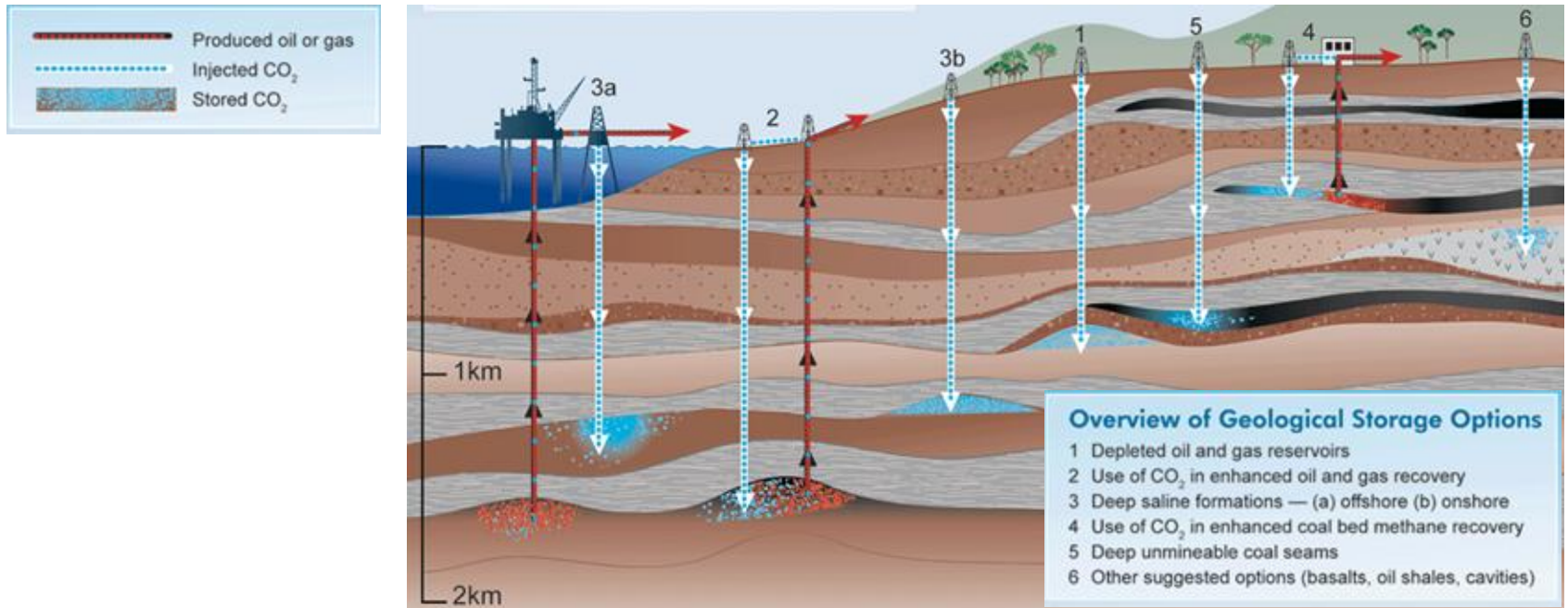

Prediction of CO₂ Sequestration effectiveness depends on understanding:

- Reactive fluid flow properties of multiphase fluids under reservoir conditions in porous and fractured media
- Geochemical stability of mineral phases within deep formations
- Improved geophysical imaging of reservoir-scale properties to track changing reservoir dynamics over long periods of time



Energy Frontier Research Center: Center for Frontiers of Subsurface Energy Security

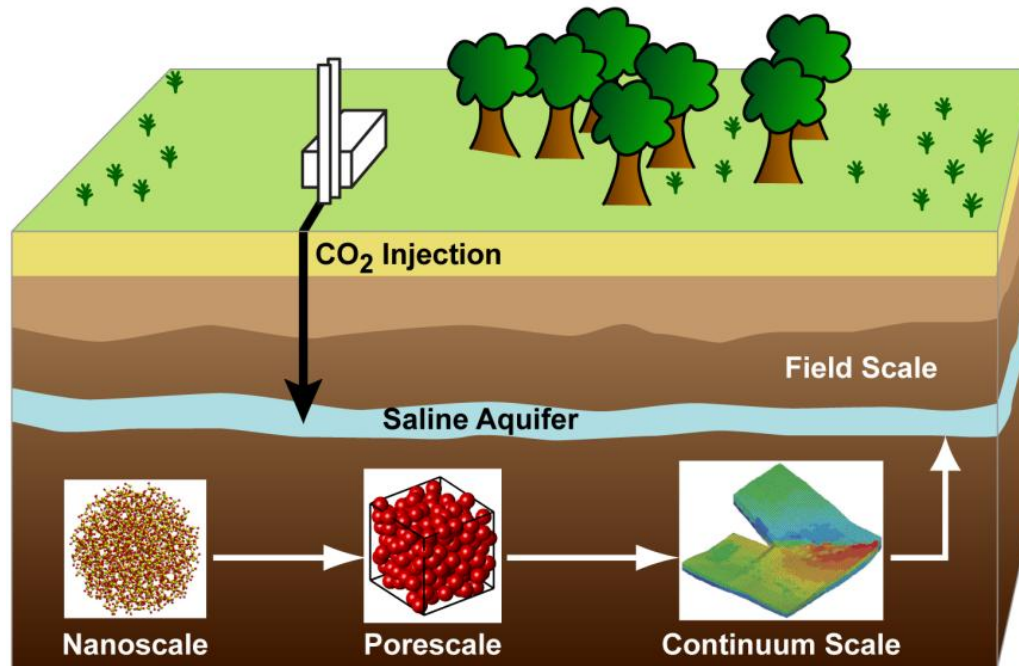

RESEARCH OBJECTIVES:

Development of scientific understanding of subsurface physical, chemical and biological processes from very small to very large scale so that we can predict the behavior of CO₂ and other byproducts of energy production stored in the subsurface.



Energy Frontier Research Center: Nanoscale Controls on Geologic CO₂

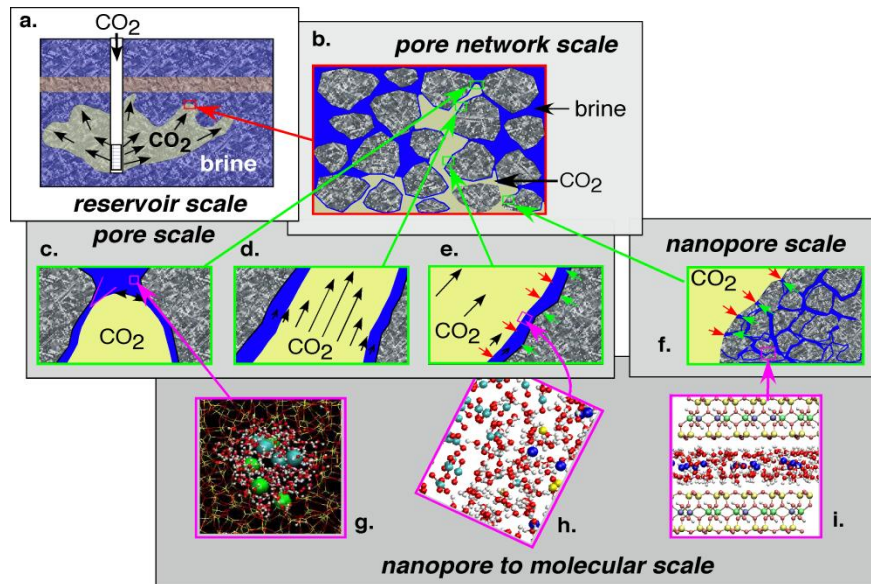

RESEARCH OBJECTIVES:

- (1) Development of molecular, nano-scale, and pore network scale approaches for controlling flow, dissolution, and precipitation in subsurface rock formations during emplacement of supercritical CO₂; and
- (2) Achievement of a new level of prediction of long-term performance



U.S. DEPARTMENT OF
ENERGY

Office of
Science



UC DAVIS
PETER A. ROCK
Thermochemistry
Laboratory



OAK RIDGE NATIONAL LABORATORY
Managed by UT-Battelle for the Department of Energy

Science for Transportation Fuel Switching

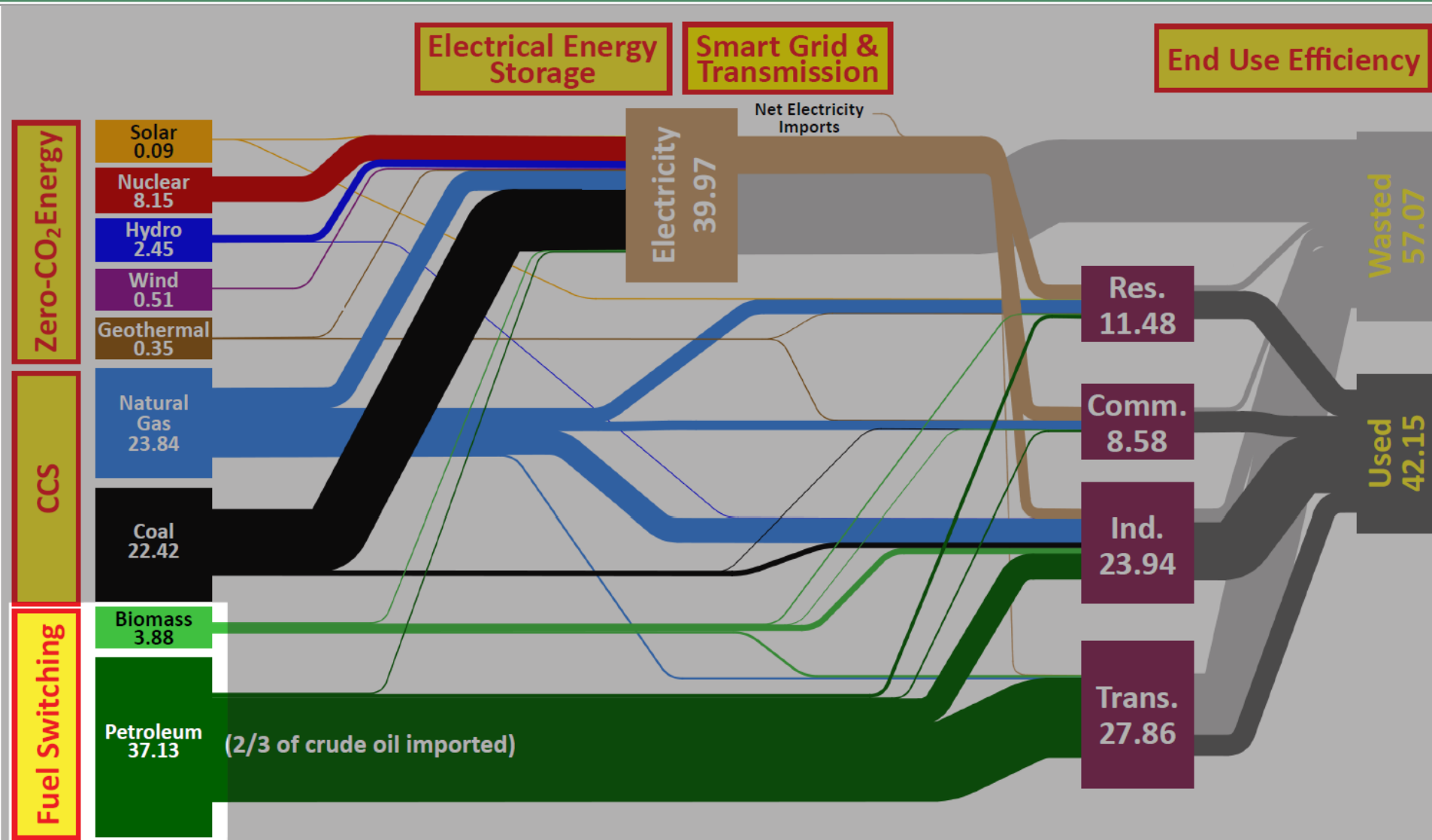

The DOE Bioenergy Research Centers

Revolutionizing discovery of biofuels solutions

- **New paradigm for research—single focus, multi-disciplinary, highly integrated science**
- **Building on DOE's investments in user facilities and fundamental research programs**
- **Focus on**
 - **Feedstock characterization & development**
 - **Feedstock deconstruction**
 - **Feedstock conversion to liquid fuels**



Energy Frontier Research Center: Center for Lignocellulose Structure and Formation (PSU)

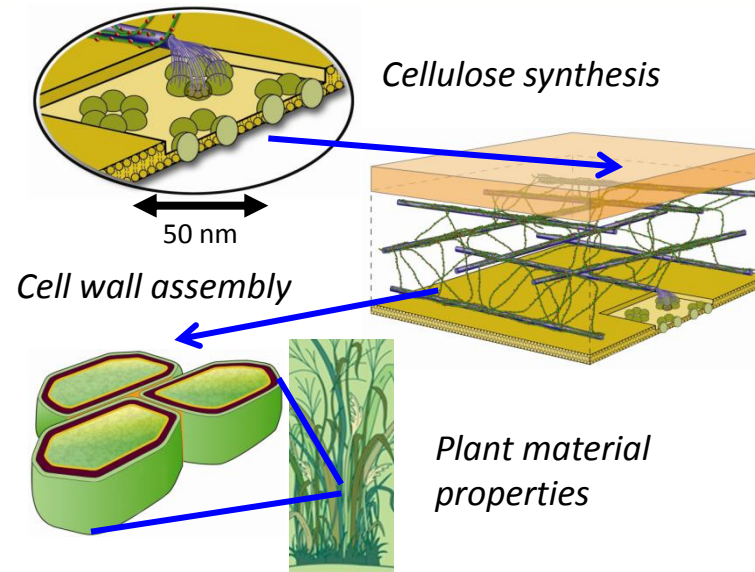

RESEARCH OBJECTIVES:

Develop a detailed understanding of the nano-scale structure of lignocellulose and the physicochemical principles of its formation through:

1. Use a nano-engineered platform to facilitate biophysical spectroscopic studies
2. Characterize the dynamics and energetics of specific cellulose-polysaccharide-protein-enzyme-lignin binding interactions
3. Develop and validate a multiscale model that will bridge the nano and molecular scale to real-world applications including drying and chemical/enzymatic degradation



Prospects for Solar Fuels Production

What We Can Do Today

\$12/kg H₂ @ \$3/pW PV
(BRN on SEU 2005)

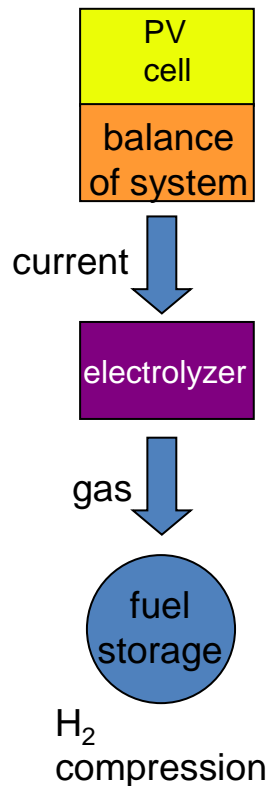

High capital costs

We do not know how to produce solar fuels in a cost effective manner.

Two Limits

Low capital costs

Chemists do not yet know how to photoproduce O₂, H₂, reduce CO₂, or oxidize H₂O on the scale we need.

Ultimate Goal

solar microcatalytic energy conversion

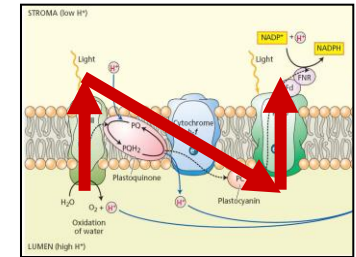

liquid

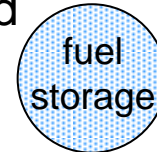

gas

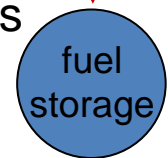

compression

Science for Electrical Energy Storage

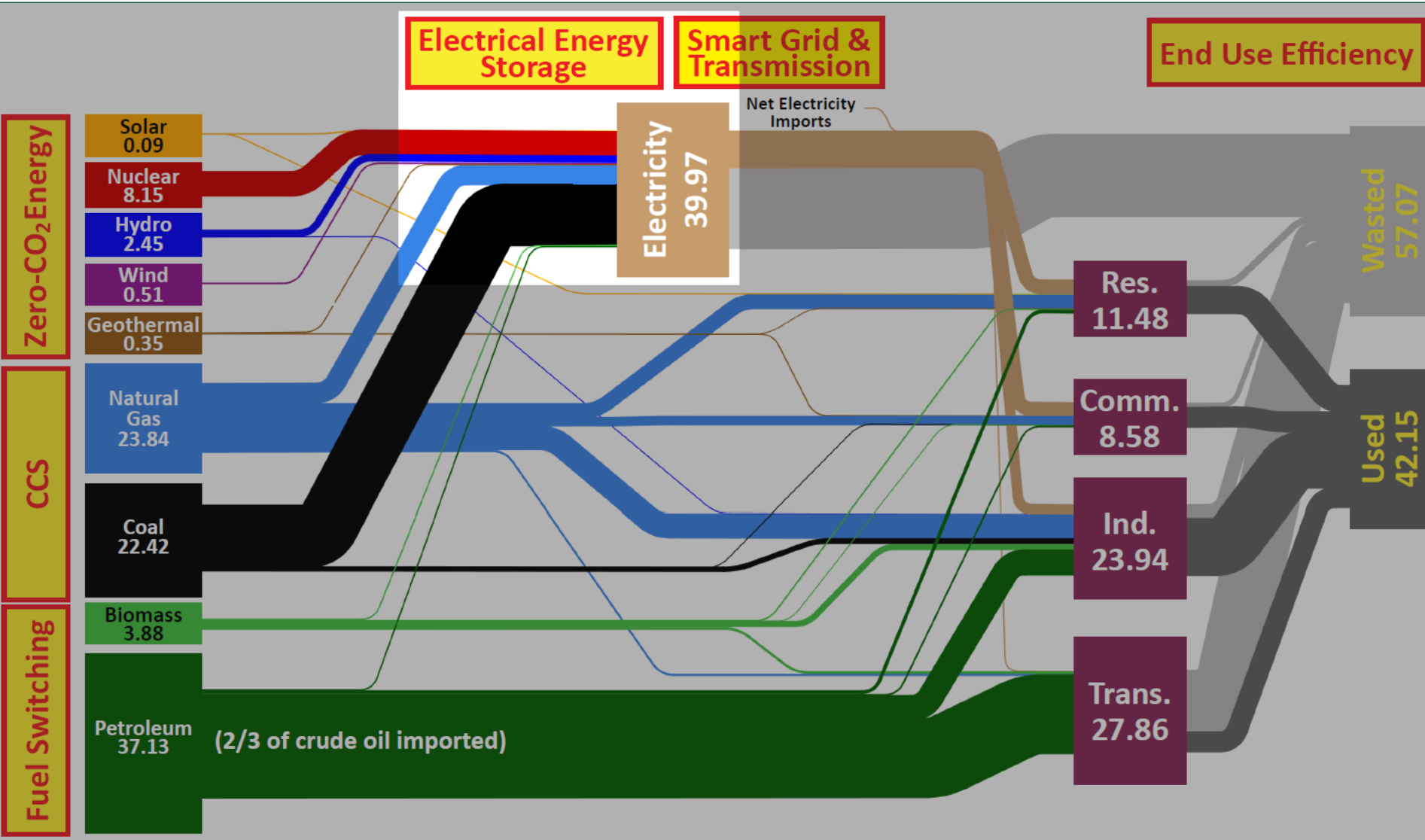

Basics: Energy Storage Time Scales

Seconds to Minutes

Regulation

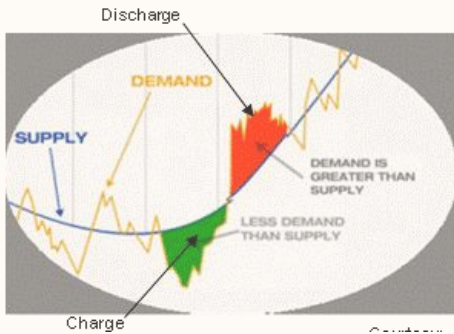

Minutes - One Hour

Ramping

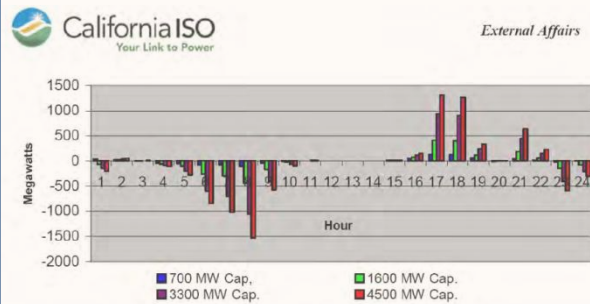

Several Hours - One Day

Peak shaving, load leveling

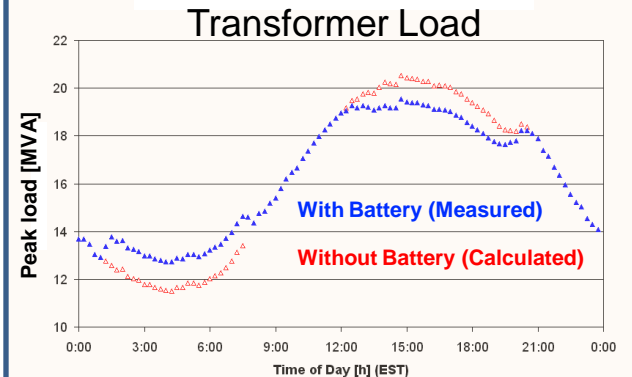

While different time regimes will require different storage solutions, there are many common science questions.

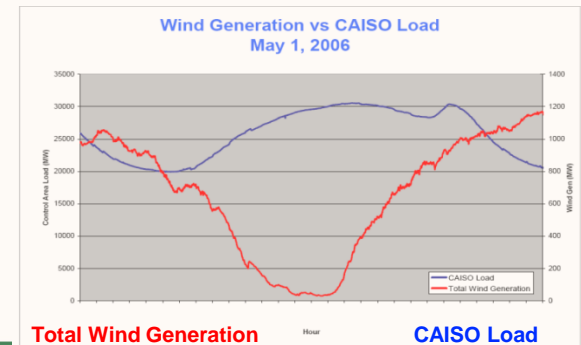
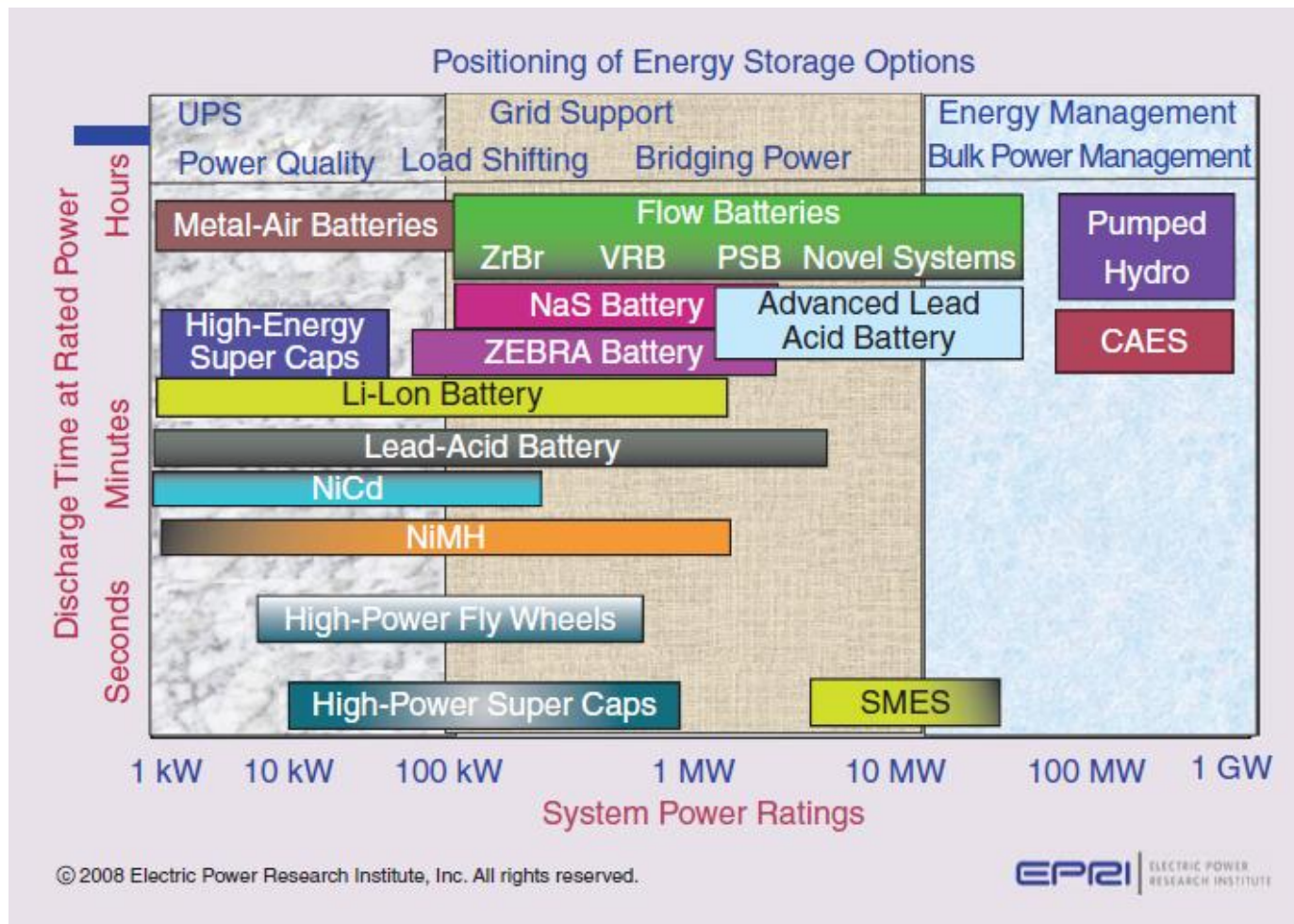

Figure 11: Total Wind vs. CAISO Load



Current Battery and Energy Storage Technologies



From Bench to Marketplace: The Story of A123 Systems

- The Office of Science sponsored basic research at MIT over a decade ago that led to the discovery of a new nanostructured cathode material for battery applications.
- Based on this discovery, the faculty member started a company, A123 Systems in Watertown, MA, to commercialize this new battery technology.
- Development was further supported by a DOE Small Business Innovation Research grant starting in 2002 and by a grant from the DOE Office of Energy Efficiency and Renewable Energy starting in 2006.
- Today A123 Systems' batteries have reached the commercial marketplace in power tools, hybrid and plug-in hybrid electric vehicles, and grid-related applications.

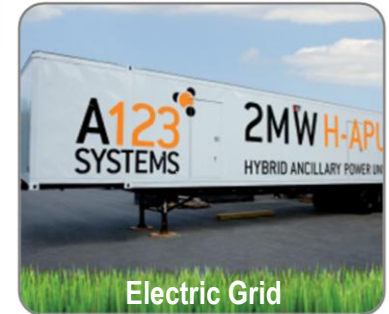

Energy Frontier Research Center: Northeastern Center for Chemical Energy Storage

Intercalation Chemistries

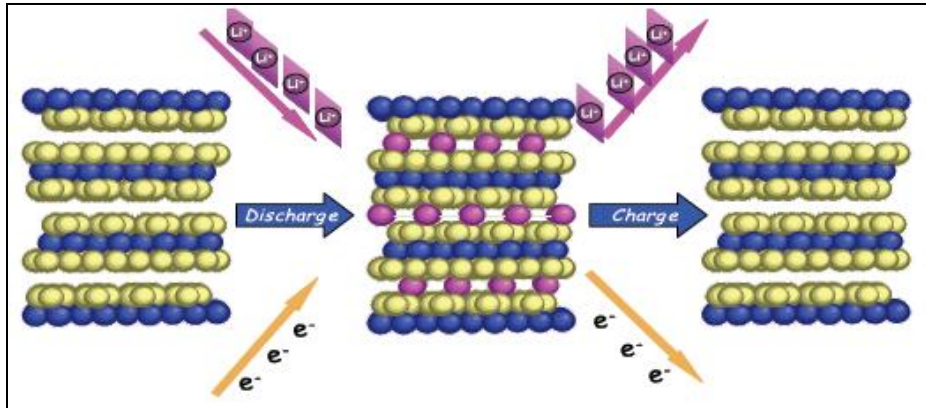

Conversion Chemistries

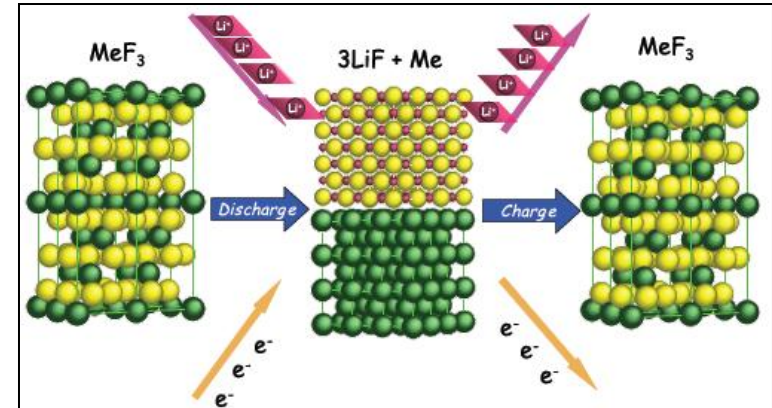

RESEARCH OBJECTIVES:

1. Develop a fundamental understanding of how key electrode reactions occur, and how they can be controlled through the development of new diagnostic tools;
2. Identify critical structural and physical properties that are vital to improving battery performance;
3. Use this information to optimize and design new electrode materials



U.S. DEPARTMENT OF
ENERGY

Office of
Science



RUTGERS
UNIVERSITY

BINGHAMTON
UNIVERSITY
STATE UNIVERSITY OF NEW YORK

BROOKHAVEN
NATIONAL LABORATORY

STONY
BROOK
UNIVERSITY

Conclusion

Let's get going!

- **PSU Energy Frontier Research Center**
- **Penn State Earth System Science Center**
- **Penn State Institutes for Energy and the Environment**
 - Resources for Faculty: <http://www.psie.psu.edu/faculty/>
 - Resources for Students: http://www.psie.psu.edu/for_students/
- **Department of Energy and Mineral Engineering Energy Club**



<http://www.eia.doe.gov/energyexplained/>

